

**SPECIAL ISSUE: PORTABLE SANITATION**

DEDICATED TO THE LIQUID WASTE INDUSTRY

# Pumper

April 2010 [www.pumper.com](http://www.pumper.com) \$5.00 U.S.

**Adapt &  
Overcome**

**Sani-Hut weathers  
economic turmoil**

**PAGE 24**

**SANI-HUT**  
COMPANY, INC.  
(775) 358-6720  
HENDON, NEVADA

**PJ-770**

**At the Expo:**

**GREAT  
STUFF!**

**PAGE 44**

PRSTD STD  
U.S. POSTAGE  
PAID  
COLE  
PUBLISHING

CHANGE SERVICE REQUESTED

COLE PUBLISHING INC., PO BOX 220, THREE LAKES WI 54662

# 10 FEET OF EXTRA WORK SPACE!



## The MD950 Is Totally Redesigned With You In Mind

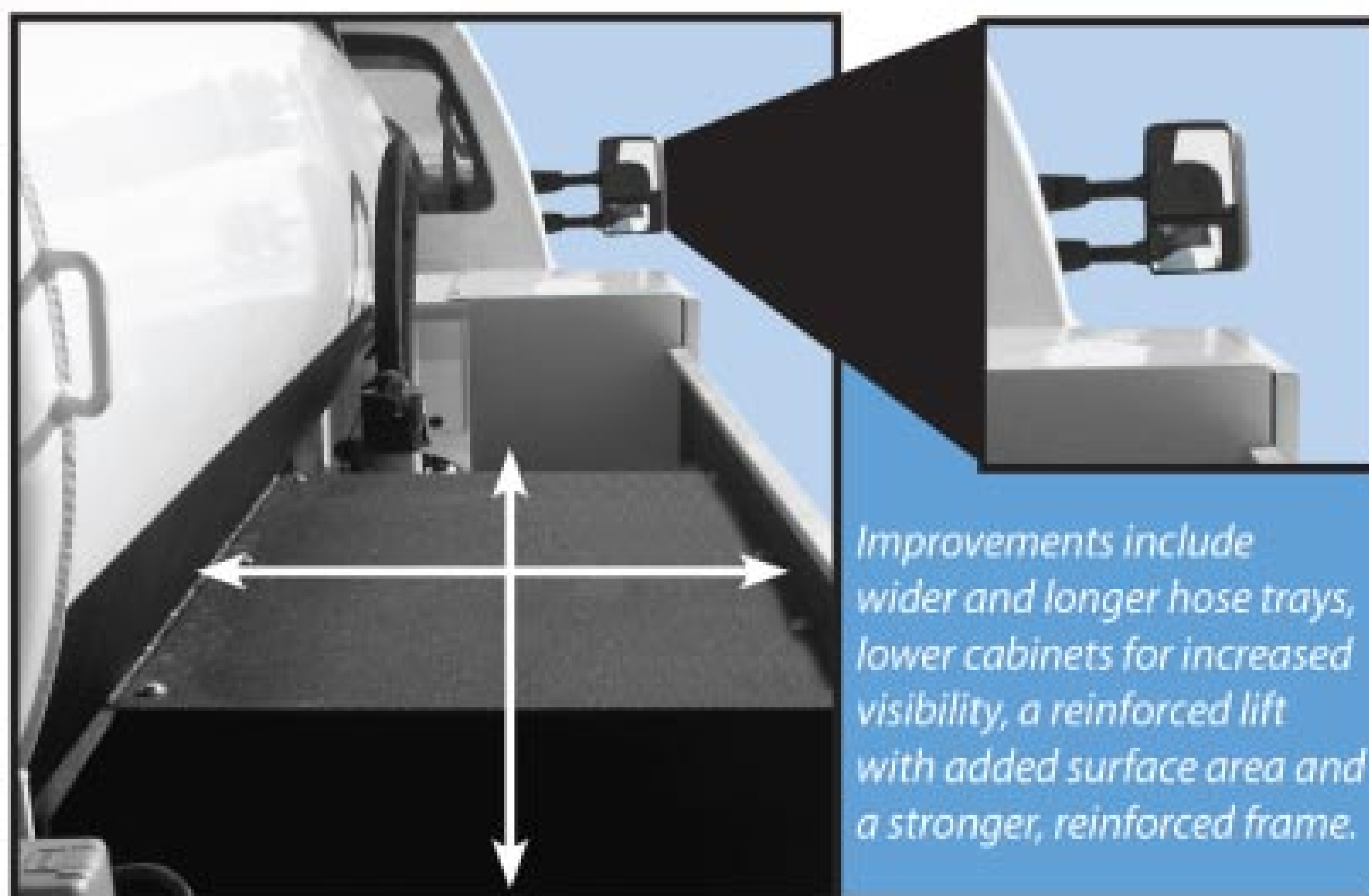

*Improvements include wider and longer hose trays, lower cabinets for increased visibility, a reinforced lift with added surface area and a stronger, reinforced frame.*

With ten square feet of extra space, your drivers will immediately notice the improved ergonomics of the newly redesigned MD950. Built with a slightly longer wheel base, the MD950 is for efficiency minded operators who like a smooth ride and steady towing.

Take a moment and call your Area Manager or our Truck Specialists at 800-328-3332 to find out more about the incredible new MD950.



**800-328-3332**

[www.satelliteindustries.com](http://www.satelliteindustries.com)

Get Ready for Spring with  
**Masport**<sup>®</sup>

**SPRING INTO  
ACTION!**

5.5 HP  
to  
24 HP



Masport Engine Driven  
Systems



Reduce oil  
carry over  
with Masport  
Oil  
Separators

Protect your pump  
with Quality Masport  
Components.



HXL4V  
Plug & Play  
System



165 CFM

The Leader in Portable  
Toilet Pumping!

**PUMPER|SCENT**<sup>™</sup>



Eliminate  
Odors with  
Pumperscent!

Toll Free: 1-800-228-4510

[www.masportpump.com](http://www.masportpump.com)



## COMPOSTING = NO LANDFILL OR LAND APPLICATION

Turn  
**SLUDGE**  
 and  
**GREASE**  
 Trap  
 Waste  
 Into  
**\$\$**



Windrow sizes from 10' to 25'



Cover your material to reduce odor

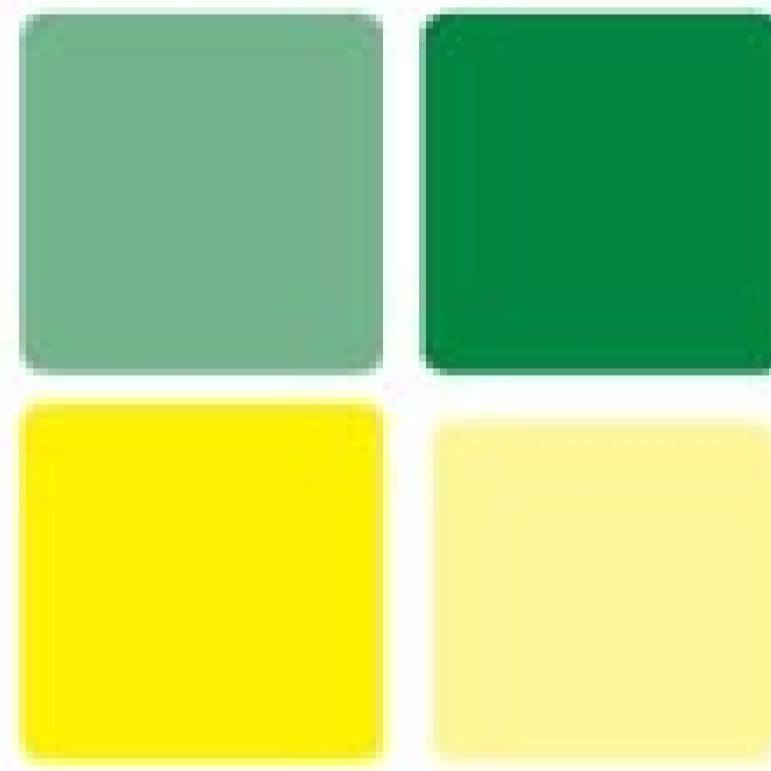

**BACKHUS**  
 North America

BACKHUS  
 North America Inc.  
 22 Cortlandt Street, 16th Floor  
 New York, NY 10007  
 Email: sales@backhus.us  
 Phone: 212 419 0515  
 Web: www.backhus.us



N40  
 P.O. Box 1330  
 Rockwell, NC 28138  
 Email: info@n40compost.com  
 Phone: (336) 499-5881  
 Web: www.n40compost.com

# Lenzyme

Solutions for all Waste & Grease Problems



ANOTHER  
**NEW**  
 BENEFIT

CALENDAR  
 REMINDER STICKERS

**YOUR MARKETING PARTNER**



**BEST PACKAGING - BEST PRODUCTS - BEST PRICE**

Discover Marketing Secrets to More Pump-Outs

**1-800-223-3083**

Call Today for Your **FREE** Sample



Trap-Cleer

Lenzyme

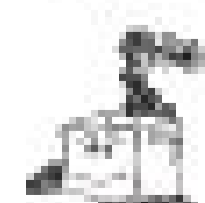

## Agribusiness Supply Company

**800-881-6720**

Call us for a free catalog!



Metaltecnica Lever Valves  
 Metaltecnica Piston Valves  
 (Threaded and Flanged)  
 Hydraulic and Air Cylinders  
 Italian Fittings  
 Secondary Shut-Offs  
 Camlock Hose Couplings  
 Superex Super T-Bolt  
 Hose Clamps  
 Vacuum Tank Accessories

**ASC**

1212 W. 7th St.  
 PO Box 508  
 Cedar Falls, IA 50613

# HOUSE OF IMPORTS TRUCK SALES

**CALL ANGEL AT:**  
**786.258.3384**  
**OR**  
**305.691.4778**

WWW.HOUSE-OF-IMPORTS.COM

## QUALITY TRUCKS CUSTOM BUILT YOUR WAY



**2007 FREIGHTLINER**  
**114K ORIGINAL MILES - 4100 GAL**  
**450 H.P. - 10 SPD.**



**2006 PETERBILT**  
**THANKS TO TERRY**  
**LOUISVILLE SHOW TRUCK**

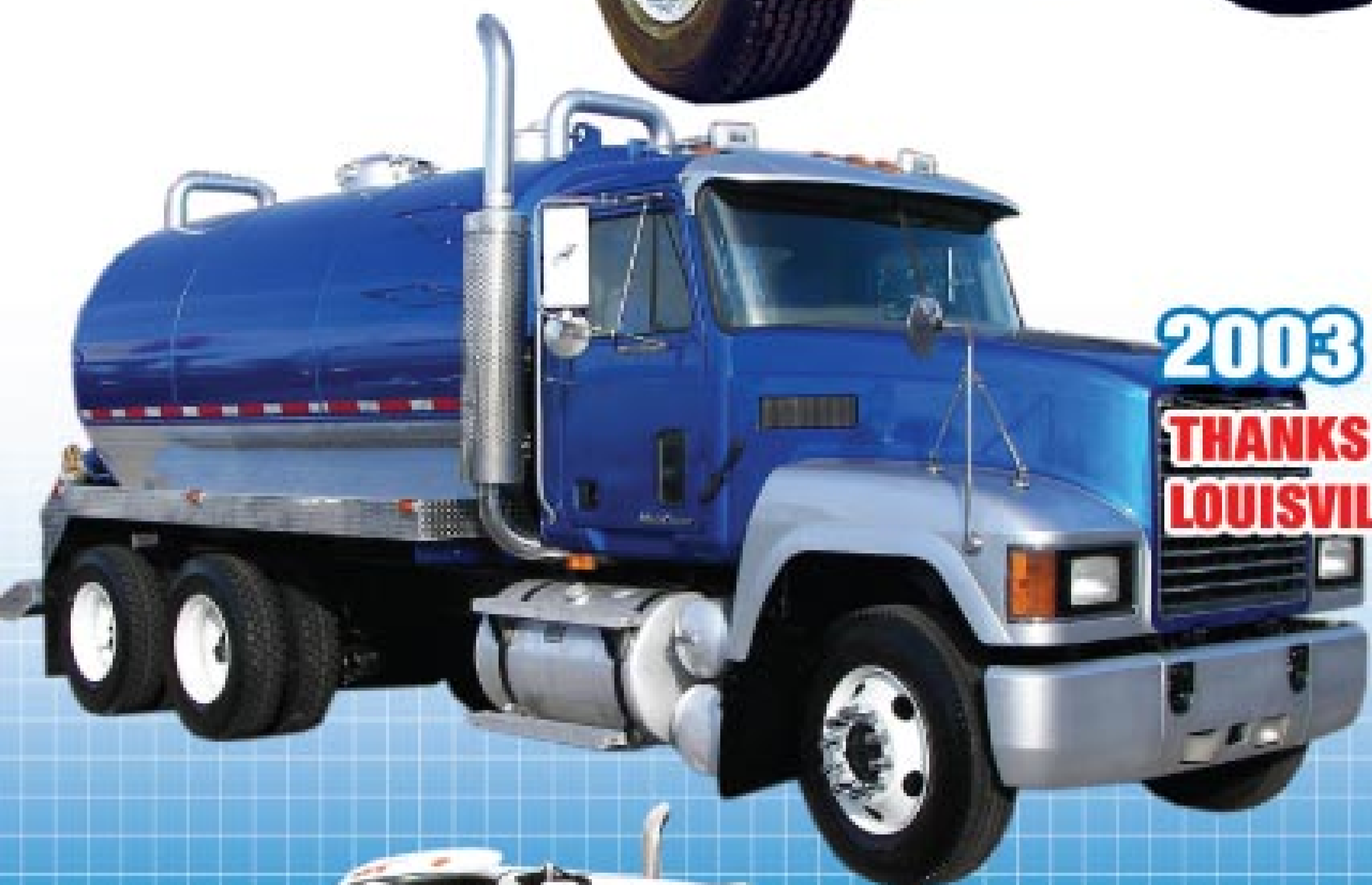

**2003 MACK**  
**THANKS TO US TANK**  
**LOUISVILLE SHOW TRUCK**



**2005 PETERBILT 335**  
**THANKS TO US TANK - LOUISVILLE SHOW TRUCK**



**2007 INTERNATIONAL 8600**  
**IN PROGRESS - 430 H.P.**

**100,000 MILE**

**LIMITED**  
**FACTORY WARRANTY**

DELIVERY EXPORT PUMP WARRANTY: 1 YEAR TANK WARRANTY: 5 YEARS

## ARTICLES

24

**Profile: Adapt & Overcome**  
- Marian Bond

Nevada's Sani-Hut employs careful management practices and new technologies to weather 50 years of economic ups and downs. **On the cover,** Sani-Hut technician Daniel Gonzalez cleans a restroom. (Photo by Lisa J. Tolda)

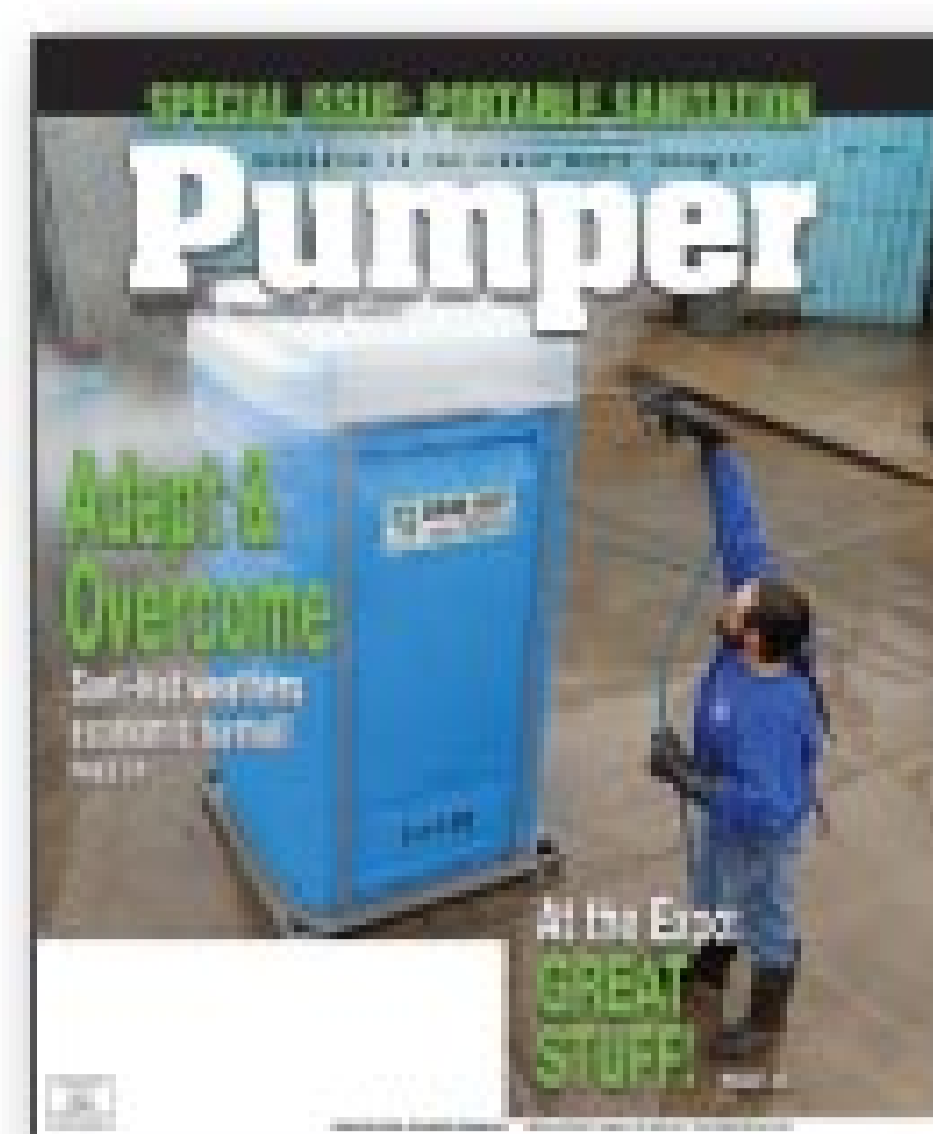

10

**Building the Business: Selling Hygiene**

You already have a contract to place a portable restroom on location. Now work to add a product that will allow users to walk away with clean hands.  
- Steve Washburn

12

**Rules and Regs: Minnesota May Inventory, Inspect All State Septic Tanks**

- Doug Day and Scottie Dayton

16

**Reading Between the Lines: It's in the Books**

Industry trends and optimism for a growing economic recovery are evident at the 30th Pumper & Cleaner Environmental Expo.  
- Jim Kneiszel

38

**Profile: Keeping Up Appearances**

Sharp-dressed restrooms, clean and responsive service brings repeat business for California's Big Valley Sanitation.  
- Seiche Sanders

44

**At the Expo: Great Stuff!**

At the Pumper & Cleaner Environmental Expo, attendees zeroed in on the best new products the liquid waste industry has to offer.  
- Jim Kneiszel and Ed Wodalski

52

**Pumper Interview: Back to School**

Staying on top of alternative onsite system technologies and learning about greywater recycling are hot topics for Oregon's industry association.  
- Scottie Dayton

58

**Overheard Online: What Pump Oil Are You Running?**

Using the right lubricant and providing good maintenance, pumpers report they're keeping vacuum pumps running smoothly for years and years.

## REGULAR FEATURES

64

**Money Manager: Dealing With Debt**

A difficult economy can mean strains on small-business finances. Take this advice to help keep debt from dragging your business down.  
- Fred S. Steingold

70

**Reader Pipelines: Double Duty**

Pumpers share their tips on effective employee cross-training to get the most out of the workforce.  
- Mary Shafer

74

**Industry News**

76

**Septic System Answer Man: Fill 'er Up!**

With proper soil treatment system design, effluent should rise to the top of the trench rock or other distribution medium before flowing to a second trench.  
- Roger E. Machmeier

80

**Classy Truck of the Month**

We feature Raider Rooter, Boynton Beach, Fla.

84

**NAWT News: Reorganization for Maximization**

Fifth Annual NAWT Waste Treatment Symposium restructured based on attendee comments.  
- Tom Ferrero

88

**Association News; Training and Education; Calendar**

Coming in MAY

**SPECIAL ISSUE:  
Onsite Septic Systems**

- **Contractor Profile:** Mentor helps Oklahoma pumper become successful
- **Building the Business:** Understanding contracts developed for online customers

# Pumper.

DEDICATED TO THE LIQUID WASTE INDUSTRY

[www.pumper.com](http://www.pumper.com)

Published monthly by

 COLE Publishing

COLE Publishing Inc.  
1720 Maple Lake Dam Rd.  
PO Box 220  
Three Lakes WI 54562

© Copyright 2010 COLE Publishing Inc.  
No part may be reproduced without permission of the publisher

In U.S. or Canada call toll-free 800-257-7222  
Elsewhere call 715-546-3346  
E-mail: [info@pumper.com](mailto:info@pumper.com)  
Web site: <http://www.pumper.com>  
Fax: 715-546-3786

Office hours 7:30 a.m. - 5:00 p.m. Central Time, Monday - Friday

**SUBSCRIPTION INFORMATION:** A one year (12 issue) subscription to Pumper in the contiguous 48 U.S. states costs \$16 (24 issues for \$26; 36 issues for \$36). Subscriptions to Canada or Mexico cost \$28 per year (24 issues for \$54). Subscriptions to all other foreign countries cost \$82 per year. Subscribers are guaranteed monthly delivery of the magazine. To subscribe, send company name, mailing address, phone number and check or money order (U.S. funds payable to COLE Publishing Inc.) to the address above. MasterCard, VISA and Discover are also accepted. Supply credit card information with your subscription order.

Our subscriber list is occasionally made available to carefully selected companies whose products or services may be of interest to you. Your privacy is important to us. If you prefer not to be a part of these lists, please contact Nicole at [nicole@colepublishing.com](mailto:nicole@colepublishing.com).

**CLASSIFIED ADVERTISING: RATE:** \$1.00 per word, per month. Minimum of 20 words or \$20. All classified advertising must be PAID IN ADVANCE. **DEADLINE:** Classifieds must be received by the tenth of the month for insertion in the next month's edition. **PHONE-IN ADS ARE NOT ACCEPTED.** Submit classified ads online at [www.pumper.com](http://www.pumper.com). Ads may be faxed only when charging to MasterCard, VISA or Discover. Please supply all credit card information with faxed ads. Be sure to include your phone number (with area code) in your ad. Make checks payable to COLE Publishing Inc. and mail with classified ad to the address above. **CLASSIFIED ADVERTISING APPEARS NATIONWIDE AND ON THE INTERNET.** Not responsible for errors beyond first insertion.

**DISPLAY ADVERTISING:** Call 800-994-7990 and ask for one of our sales staff listed below. Publisher reserves the right to reject advertising, which in its opinion is misleading, unfair or incompatible with the character of the publication.

### OUR SALES STAFF:



Kim McGee



Jim Flory



Winnie May



Jim Koshuta



Kayla Wikowski

**CIRCULATION:** Circulation averages 25,750 copies per month. This figure includes all circulation regions (nationwide) and international distribution.

## PUMPER & CLEANER ENVIRONMENTAL EXPO INTERNATIONAL



**Education Day:** March 2, 2011

**Exhibits Open:** March 3-5, 2011

Kentucky Exposition Center  
Louisville, Kentucky

[www.pumpershow.com](http://www.pumpershow.com)



# moro PUMPS

"Over 50 years of service and here to stay!"

Ask for a quality Moro pump from your truck builder, or call us for the dealer nearest you.

Pittsburgh, PA . 1-800-383-6304 . fax 412-269-4172 . www.morousaeast.com . moroeast@attglobal.net  
St. Louis, MO . 1-866-383-6304, 636.584.8844 . fax 636-583-2044 . www.morousaeast.com . moro@charter.net

## The **NEW** Moro Vacuum Pumps from **MORO USA**



**PM60A**  
233 cfm

**PM70A**  
300 cfm

**PM80**  
379 cfm

### Isn't it time to UPGRADE to a MORO?

## Complete Right Angle Packages

Pumps available from 176-1642 cfm

Completely Assembled



230 cfm

**M10**



**PM80**

350 cfm

460 cfm



**PM100**

## DC-STAINLESS Washdown Pump

**NO COMPARISON**



NO more  
**RUSTY**  
water!

**OUTPERFORMS**  
the Burk's  
cast iron  
DC-10!

NO More  
**FROZEN**  
pump!



316 Stainless Steel Mounting  
Brackets, Pump Head & Impeller

## Quality RIV Components In Stock — Ready for Shipment



## ACCU-LEVEL

### Accurate Tank Volume Measurement

**No Balls • No Tubes • No Floats • No Worry!  
No Internal Tank Components**

Get paid for what you pump!

Only pay for what you dump!



**Level Indicator**

Factory calibrated, the general purpose indicator reads 0-100% of volume in gallons. A single push button allows users to scroll through their active channels.



**Pick-up Unit**

The general purpose two-wire transmitter provides non-contact level measurement up to 32' and is ideally suited for challenging corrosive, coating or waste liquids.

# ADVERTISER index .....

April 2010

27th Trucks.....60

## A



Abbott Rubber Co. Inc.....78



Abernethy Welding & Repair.....34



Acro Trailer Company.....32

Agribusiness Supply Co.....4

AlturMat Mats Inc.....18



Amazing Machinery Inc.....86



American Machine & Tool.....89

Amthor International.....29

Aqua Ben Corp.....12



Aqua-Zyme Disposal Sys.....56



Arcan Enterprises Inc.....72



ARMAL Inc.....23



Armstrong Equipment.....13

Art's Truck & Equipment.....72

Atlanta Rubber & Hyd.....54

## B

B<sup>2</sup> Business Brokers.....35

BACKHUS North America Inc.....4



Badger Vacuum Trucks.....54

Bandlock Corp.....74



Best Enterprises Inc.....55



Brenlin Company Inc.....80

## C

Cam Spray.....32

Cape Cod Biochemical.....34

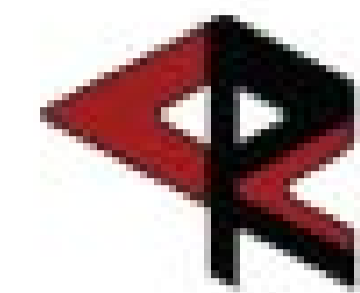

Capital Rubber Corp.....62

Center Capital Corp.....66



Chandler Equipment Inc.....9, 11



Chempace Corporation.....20



Clear Computing Inc.....64



Comforts of Home Services.....18



Crust Busters/Schmitz Bros.....34

## D

Denver Truck Sales.....89

## E

Ecological Laboratories Inc.....32



Elastec/American Marine.....81

Elmira Machine Industries.....79

EnviroTub.....30

Erickson Tank & Pump.....20

## F

Fergus Power Pump Inc.....10



Flo Trend Inc.....60

FMI Truck Sales & Service.....22



Fruitland Tool & Mfg.....66

## G

GapVax Inc.....61

Granite Leasing Co.....30

Green Way by PolyPortables.....31

## H



Hannay Reels.....87

House of Imports.....5

## I

Imperial Industries Inc.....37

## J



J&J Chemical Company.....71

Juggler by Labrie

Environmental Group.....68

## K

KeeVac Industries Inc.....87

Kentucky Tank Inc.....68

Key Commercial Corp.....54

Kleen Pro Tech.....42

## L

L.C. Tanks.....78

L.M.T. Inc.....42

Lane's Vacuum Tank Inc.....87



Lely Manufacturing Inc.....18



Lenzyme Inc./Trap-Clear.....4

Liberty Financial Group Inc.....50

Longhorn Tank & Trailer.....81

## M



Marsh Industrial.....53



Masport Inc.....3

McKee Farm Technologies.....79

Mid-Continent Truck Sales.....99

Mid-State Tank Co. Inc.....85

Milwaukee Rubber Prod.....51



Moro USA East Inc.....7

## N



National Vacuum Equip.....75

NuConcepts.....50



Nuhn Industries LTD.....22

## P



Pik Rite Inc.....83

PolyJohn Enterprises.....107

Polylok Inc.....106

PolyPortables Inc.....49

Power Line Industries.....20

Power Vac Inc.....83



Pressure Lift Corp.....82

Presvac Systems Ltd.....108

Prototek Corporation.....42

## R

Ritam Technologies LP.....85

Robinson Septic Service.....50

RotoSolutions Inc.....90



Rush Refuse Systems.....63

## S

Satellite Industries Inc.....2, 14-15



Septic Services Inc.....62

Smithco Mfg. Inc.....82

Specialty B Sales.....28

Surco Products.....59

Sweet Septic Systems Inc.....85

## T



T&T Tools Inc.....56



TankTec.....57

TCF Equipment Finance.....90



Toico Industries Inc.....72



Transport Truck Sales.....73



Transway Systems Inc.....21

TSF Company Inc.....67

TST, LLC.....74

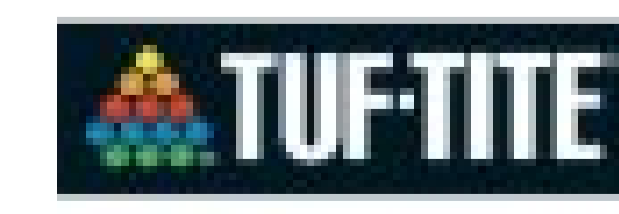

Tuf-Tite Inc.....65

## V

V.E. Enterprises Inc.....28

Vac-Con Inc.....43

Vacutrux Limited.....79



VAR Co.....33

## W

Walex Products Co. Inc.....69

Water Cannon Inc.....77



Wee Engineer Inc.....90



Westmoor Ltd.....19



Wilcox Truck Sales.....30

**Classifieds.....100**

**Marketplace.....91**

**Truck Stop.....94**

## REGIONAL ADVERTISERS

### Midwest Supplement

(after page 74)

Advance Pump & Equip.....4

Engle Fabrication LLC.....6

Heritage Truck Equipment.....5

Marengo Fabricated Steel.....7

Pat's Pump & Blower.....2

R.A. Ross N.E.....6

Rider Vacuum Sales.....3

T-Line Equipment Inc.....5

V&H Inc.....2

### Eastern Supplement

(after page 74)

Advance Pump & Equip.....4

Andert Inc.....6

Heritage Truck Equipment.....5

Manchester Hose & Coupling.....5

Marengo Fabricated Steel.....7

Pat's Pump & Blower.....2

R.A. Ross N.E.....6

TSI Tank Services Inc.....4

V&H Inc.....2

Vacuum Sales Inc.....3





## RV360

Hi-efficiency dual fan air cooled  
24" Continuous Duty  
360 CFM  
1200 - 1300 RPM Range  
Integrated 4-way Valve Manifold



## RV520

Hi-efficiency dual fan air cooled  
24" Continuous Duty  
520 CFM  
1200 - 1300 RPM Range  
Integrated 4-way Valve Manifold

# ALL NEW JUROP RV SERIES PUMPS

available exclusively from **Chandler Equipment**



Ph **1-800-342-0887** | Fax **1-888-645-9700**  
Visit our **NEW** website at [www.chandlerequipment.com](http://www.chandlerequipment.com)

**Jurop**  
NORTH AMERICA



Call today and ask us  
about our exclusive line  
of **Atex Certified** pumps!

# Selling Hygiene

**You already have a contract to place a portable restroom on location. Now work to add a product that will allow users to walk away with clean hands.**

**By Steve Washburn**

In today's world of the H1N1 flu pandemic and E. coli bacteria outbreaks, hand-washing and hand sanitizing have become critical components of disease prevention — especially in public places. For portable restroom operators servicing construction sites, agricultural operations or special events, this means portable sinks and hand sanitizers will become even more valuable rental items this year.

But how do you sell hand hygiene to customers? Here are some pointers:

## **Sell the benefits of clean hands.**

Statistics that illustrate the importance of good hand hygiene are everywhere. Make use of the numbers when you talk to your customers. The facts are staggering, as laid out by the U.S. Center for Disease Control and Prevention and the Food & Drug Administration.

- According to the CDC, 80 percent of infections are spread by the hands. Hand washing reduces both infection and the spread of harmful pathogens.
- Some viruses (like H1N1) can survive on surfaces for up to 48 hours. It's most important to wash your hands after using the restroom, before eating, after handling pets, and after coughing or sneezing.
- A recent study by the FDA reveals that proper hand washing can stop up to half of all food-borne illnesses, including *E. coli* and salmonella.
- A study of children showed that those who washed their hands at least four times a day experienced 24 percent fewer sick days from colds and flu viruses. This is a good statistic to mention to contractors who want to eliminate sick days among crews.

## **Know what product works best in every situation.**

Before you get into renting portable hand-sanitizing equipment, realize that different equipment options solve different types of problems. There are sinks and sanitizers, alcohol-based gels, foams, and

*Steve Washburn is Director of Special Projects at PolyJohn Enterprises Corp., Whiting, Ind. Reach him by e-mail at [steve.washburn@polyjohn.com](mailto:steve.washburn@polyjohn.com).*



**A study of children showed that those who washed their hands at least four times a day experienced 24 percent fewer sick days from colds and flu viruses. This is a good statistic to mention to contractors who want to eliminate sick days among crews.**

wipes, as well as alcohol-free versions of those same products. Depending on the equipment you offer, you will undoubtedly be asked, "Which works best: soap and water or hand sanitizer?" Truly, it depends on your customer's situation.

For rentals to construction or agricultural jobsites or events with food preparation or live animals, sinks are the more hygienic option. A study by the University of Florida found that hand washing with soap and water is most reliable because soap helps reduce surface tension on the hands, making it easier to wash away dirt and germs.

On the other hand, if you're servicing an event where the end user simply needs to wipe cotton candy from the hands, a hand-sanitizing station with wipes or foam would make sense. Whether an alcohol-based or alcohol-free solution, sanitizers disinfect by stripping the outer layer of oil off of the skin, destroying any microorganisms living on it. Though they do not clean as deeply as soap and water, sanitizers are very effective at killing germs in most situations.

## **Understand effective placements.**

Every delivery of portable restrooms leaving your yard should be accompanied by an appropriate number of portable sinks. What is the "appropriate" number? It's a good question, and the answer depends on where you look. Special event guidelines from cities across the country offer different recommendations. In Jacksonville, Fla., the ratio is one sink for every five restrooms; in Berkeley, Calif., it's one to four, and in Greenville, S.C., it's one to 10.

While it's important to learn the standards for your area, a good "rule-of-thumb" is found in the disaster relief guidelines from the American Red Cross. They recommend a sink for every two restrooms — a number consistent with the expected number of uses from a portable sink (about 500) and a portable restroom unit (200) before servicing.

## **A FINAL WORD**

When done right, adding hand-sanitizing solutions to your portable sanitation mix is a benefit to your customers and your business. Not only does good hand hygiene protect the health of your community, it also meets basic customer needs. ■



**"Duel Power Lid"**  
Plugs, Lids & Adaptor Rings  
Sizes Available: 18", 24", 30" & 36"  
**Fergus Power Products**  
Providing "Environmental Products"  
*The Company who maintains a pulse on the environment!*  
Toll Free **1-800-243-7584**  
E-mail [fpproducts@prtcl.com](mailto:fpproducts@prtcl.com)  
[www.FergusPowerProducts.com](http://www.FergusPowerProducts.com)



**METALTECNICA** s.r.l.

# Dares are our job!

## Cast iron valve with knife in stainless steel



USA DISTRIBUTOR



Toll Free 1-800-342-0887 - [www.chandlerequipment.com](http://www.chandlerequipment.com)



[www.metaltecnicazanolo.com](http://www.metaltecnicazanolo.com)

By Doug Day and Scottie Dayton

Rules and Regs is a monthly feature in Pumper. We welcome information about state or local regulations of potential broad interest to onsite contractors. Send ideas to [editor@pumper.com](mailto:editor@pumper.com).

## Minnesota May Inventory, Inspect All State Septic Tanks

**B**y Sept. 15, Minnesota should know the location of all septic systems in the state. An audit was ordered by legislative action in 2009 requiring "directly or indirectly inspecting and providing an inventory for all subsurface sewage treatment systems." It calls for direct inspection of each system "on riparian land or lake or near wetlands or other sensitive waters" to see if they are failing or provide an imminent health threat.

Minnesota has seen an increase in funding for sewage programs through the Clean Water Legacy sales tax amendment passed by voters in 2008. It raised the sales tax from 6.5 percent to 6.875 percent from July 1, 2009, through June 2034. A third of the revenue, expected to be \$80 million in 2010, is earmarked for clean-water projects.

### CONNECTICUT

The state Department of Environmental Engineering is changing to electronic distribution for all notices, training announcements and circular letters and will no longer use postal mail. To sign up, e-mail your electronic contact information to [Kathy.graff@ct.gov](mailto:Kathy.graff@ct.gov). The change does not affect notifications from local health departments or sanitarians.

### INDIANA

The state Court of Appeals has ordered the City of Indianapolis to refund nearly \$9,000 to each of 30 homes forced to abandon their septic tanks and hook up to the city's sewer system. A class action lawsuit sought reimbursement for those who paid the 2004 special assessments in full rather than on installment plans.

When the city later changed its policy to require a flat fee of \$2,500, those on payment plans were forgiven their outstanding balances, but those who had already paid received no relief. The city was also ordered to pay interest on the money along with the plaintiffs' attorney fees.

### MARYLAND

In response to President Barack Obama's executive order calling for an overhaul of the Chesapeake Bay environmental restoration, a 24-

point strategy sent to the Administration is said to be more stringent than a plan being developed by the U.S. Environmental Protection Agency.

An official with the EPA says local and state cooperation will be necessary because the Clean Water Act does not have authority over septic systems and other matters. Officials promised a cleanup by 2010, but the effort has fallen about 40 percent short of goals. Maryland funded upgrades to about 1,000 septic systems, according to the *Washington Post*, but many of the state's 420,000 systems need upgrades as well.

### MICHIGAN

A troubled septage plant in Traverse City nearly broke even in 2009, but still faces about \$3 million in losses over the next five years. A holding tank collapsed shortly after the plant opened in 2005. Attorneys are looking into questions over liability for design problems and an independent review issued in January cited a lack of reasonable professional care on behalf of engineers and project managers.

Local governments issued nearly \$8 million in guaranteed bonds to fund the project. The report states, "It is unlikely the aeration tanks were tested prior to the certificate of substantial completion or they would have collapsed then." It also says the engineering firm that planned for, designed and built the facility overstated estimated volumes, leading to lower-than-expected revenues.

### MISSOURI

Gov. Jay Nixon proposed changes to state law to help clean up the Lake of the Ozarks and other state waters. Among other things, the proposal would give the state power to inspect septic tanks, including 50,000 septic systems near the lake, a popular tourist destination.

The owners of failed septic systems could be ordered to make repairs, connect to a sewer system, or stop using the system. Nixon announced his proposal in December, several months after a newspaper investigation found that the state Department of Natural Resources had withheld a report revealing dangerous levels of E. coli bacteria in the Lake of the Ozarks. The Senate Environmental Committee is investigating the incident, which caused five DNR officials to leave the agency, and led to a two-week suspension for its director.

### NEW YORK

The Catskill Watershed Corp. is offering assistance to homeowners in the Catskill-Delaware watershed who paid for the repair or replacement of septic systems in 2009. The agency will reimburse the cost for work done outside the priority areas for its Septic Repair and Rehabilitation Program if they were approved by the Department of Environmental Protection. Full-time residents are eligible for 100 percent reimbursement. Part-time residents can get 60 percent of their costs reimbursed. ■

## Coagulants and Flocculants

for Septic, Grease, Municipalities and Industry

**Celebrating 33 YEARS in business**



Save Money • Save Time • Save Polymer

- Dewatering polymers for all dewatering equipment
- All forms: Dry and Emulsion
- Variety of packaging sizes to meet customer needs
- Both East & West coast shipping points
- Expert technical staff
- Specific solutions for our customers

**Aqua Ben Corporation**  
1390 N. Manzanita St. • Orange, CA 92867  
[www.aquaben.com](http://www.aquaben.com) • [sales@aquaben.com](mailto:sales@aquaben.com)

Call Toll-free: **877.771.6041**

# NO COMPROMISE

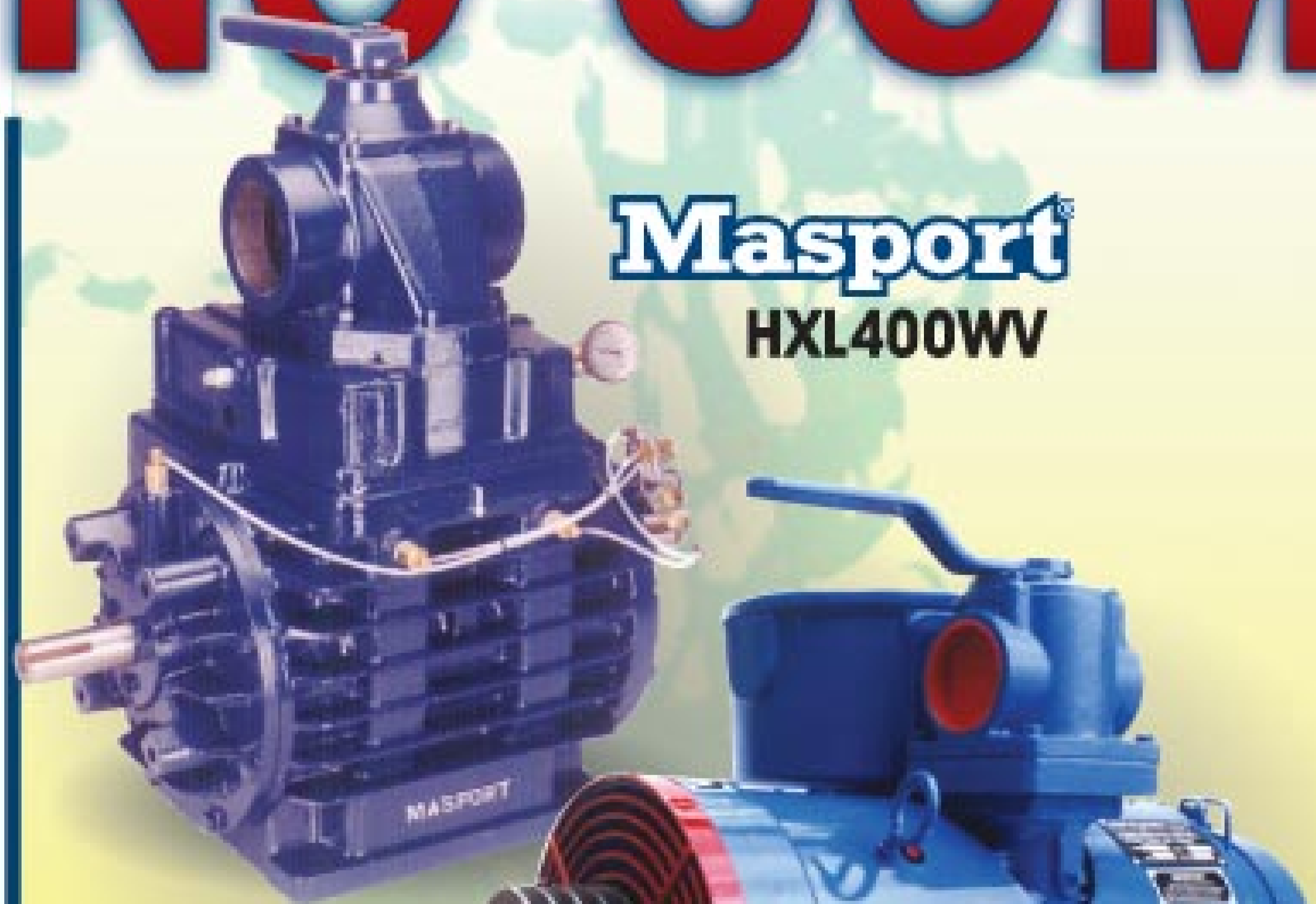

**Masport**  
HXL400WV

**At Armstrong Equipment,** we believe life and business require certain compromises, but not on those things on which your business and family depend. A beautiful, new and shiny vacuum truck with a burned out pump is nothing more than uncomfortable transportation at four miles per gallon.

Your customers depend on you! Your employees depend on you! Your family depends on you!

We think you should be able to depend on **us!** That is why we sell the most dependable vacuum pumps, parts, valves and tank components available. When it comes to quality and reliability in the tools that make your business successful, there should be:

**"No Compromise."**

We proudly stock Masport, Jurop, NVE, Fruitland and G-D Wittig vacuum pumps, Sutorbilt blowers, Garnet Instruments SeeLevel gauges, Clearflow Heavy Duty valves and most other vacuum truck components and accessories. We can also provide replacement pumps and repair kits for most major brands. For more information call us toll free at **800-699-7557**.

## ARMSTRONG EQUIPMENT INC.

**800-699-7557**

11200 Greenstone Ave. • Santa Fe Springs, CA 90670

562-944-0404 • Fax: 562-944-3636

[www.vacpump.com](http://www.vacpump.com)

Hablamos Español



**FRUITLAND**  
RCF500F



**GD Wittig**  
RFL100



**GD Sutorbilt**  
4M



**NVE**  
506

**Juop**  
R260

# STIMULUS

## HIGH RISE™

- Easy Fold Down Roof (optional)
- Galvanized Steel Frame and Floor



## HandiStand™

### Event Hand Sanitizer Stand

- Wide, Heavy Base
- 4 Dispensers



# PACKAGE

*Satellite customers will be pleased to know that even during a slow economy we are moving forward with NEW and IMPROVED products to help you compete.*



**Tufway™**

**New and Improved  
Door and Side  
Panel Design!**



**800-328-3332**

[www.satelliteindustries.com](http://www.satelliteindustries.com)

**MD950**

**The Redesigned MD950  
Has Improved Handling,  
Visibility and More  
Work Space.**





## It's in the Books

**Industry trends and optimism for a growing economic recovery are evident at the 30th Pumper & Cleaner Environmental Expo** *By Jim Kneiszel, Editor*

It was something old and many things new at the 30th annual Pumper & Cleaner Environmental Expo International, which wrapped up Feb. 27 in Louisville, Ky.

First the old: Robert "Pepi" Murrell, owner of Pepi Sewage Disposal in Port Severn, Ontario, Canada, displayed a T-shirt he purchased at the first Expo in Nashville, Tenn., in 1981, then called the Liquid Waste Haulers Equipment & Trade Show. Murrell showed off the shirt in the Vacutrux booth, then walked the show floor wearing a new 30-year anniversary shirt bought at the 2010 Expo.

Like Murrell, I met other attendees and exhibitors who remembered going to that first show in Nashville, or at least most of the Expos since. Looking back, they marveled at how that first little show blossomed into a major event with some 500 exhibitors spread out in the Kentucky Exposition Center, one of the biggest tradeshow spaces in the country.

### FORWARD THINKING

If anecdotal evidence from the show floor means anything, many attendees signaled that the worst of the economic tsunami that hit in November 2008 has passed and service companies are starting to gear up for a brighter future. Many contractors were looking to add new equipment or upgrade existing machines that are starting to show wear and tear. And exhibitors reported a constant stream of customers with questions about ordering new prod-



Robert "Pepi" Murrell, owner of Pepi Sewage Disposal in Port Severn, Ontario, Canada, displayed a T-shirt he purchased at the first Expo in Nashville, Tenn., in 1981.

ucts for the 2010 busy season.

Staffing the COLE Publishing editors booth and roaming the aisles to learn about new technologies, I spoke to dozens of contractors from across the country, and far beyond in Australia, Brazil and other far-flung locales. Most voiced optimism for a busier year ahead. Many were looking for new trucks to prevent service hiccups this summer, and a good number were seeking equipment to help diversify their core businesses.

I came away with a few observations about dynamic directions we can expect traditional septic pumpers will be heading. In many cases, they're looking to step out into other areas, and

said customer trends are showing them the way to diversification.

### CARRYING WATER

It's boom times for some contractors in Pennsylvania, who have found a dynamic, new market for their traditional septic-pumping trucks and their trained technicians: natural gas extraction.

If you don't live in Pennsylvania, West Virginia and parts of Ohio and New York, huge stores of natural gas in the Marcellus Shale might be news to you. But geologists say that deep below the Earth's surface in this Appalachian region is a huge supply of natural gas that — up until now — energy companies had no effective way to tap.

Now technology exists to drill mile-deep horizontal gas wells with exacting accuracy, and energy companies are just starting to go after supplies that might provide enough gas to meet U.S. needs for decades. Luckily for pumpers in these regions, the drilling and fracturing techniques used to tap these resources requires water transported to rural areas where the boring is starting.

I spoke with one contractor at the Expo who is buying new vacuum trucks in multiples to serve these energy company customers with water for the drilling

process. And I heard about other pumping contractors doing the same, finding big-time revenue enhancement at a time when pumpers in some other areas are in a holding pattern.

This development bears watching and its impact may reverberate throughout the industry. Will a growing demand for vacuum trucks in the Marcellus Shale region affect truck availability for other pumpers who might want vehicles as the economy recovers?

What will happen to the used-truck market if the demand for these water-haulers is higher than present lofty expectations? Will a natural gas extraction niche extend beyond this targeted region as energy companies look to tap other hard-to-reach stores in other parts of the country?

This is an exciting development for pumpers in the region, but it's also interesting to watch if tremendous stores of energy can be tapped in America to hold down energy costs and reduce our reliance on imported petroleum. Later this year, we'll delve into this issue further and talk to a pumper who's benefiting from this new energy boom.

### GREASE IS THE WORD

Restaurant and other institutional grease trap service opportunities were driving contractors to look at portable drum vacuum units and trucks designed specifically to maneuver in high-density urban settings and convey the sludge that actually might have a monetary value. The message is clear: As traditional septic service





Ralph Macchio (left) and COLE Publishing co-founder Bob Kendall (right) present the Ralph Macchio Lifetime Achievement Award to NAWT Executive Director Tom Ferrero.

matures as an industry, pumpers are looking to other areas for expansion.

It may be a good play for business because municipalities are more often regulating how restaurants handle their grease. The interest may be triggered by a growing number of grease traps to service based on our convenience-crazed society. Who among us has seen a drawdown on the number of fast-food restaurants, even with a slugging economy?

Biofuel might also be a factor. While fuel prices have ebbed off of their extreme highs a few years ago, most observers think it's only a matter of time before prices at the pump and for home heating fuel are going to rise again. And if that happens, the market for biofuel — and the recycled materials to make it — will heat up again. The Expo didn't feature exhibitors showing small-scale biofuel processing plants, as it did a few years ago, but how high would prices have to spike before we see the market for those products expand again?

#### NAWT AWARD WINNERS

At its annual breakfast meeting at the Expo, the National Association of Wastewater Transporters Inc. installed a new president and handed out several annual awards. New president Roger Winter of K. Winter

Sanitation Inc., Innisfil, Ontario, Canada, addressed the group. Ralph Macchio and COLE Publishing co-founder Bob Kendall presented the Ralph Macchio Lifetime Achievement Award to Tom Ferrero, NAWT's executive director.

Outgoing NAWT President Tom Frank was given a plaque to honor his service. And Frank's son Todd Frank, a sophomore at Ashland University in Ohio, received the annual Wm. H. Hapchuk Scholarship. The trade group decided not to give the Excellence in Service Award for 2010 and will bring back that award next year.

Ferrero was honored for playing a key role in the growth of NAWT over 20 years and for his work on behalf of the Pennsylvania Septage Management Association years before that. Ferrero was a longtime owner of a family pumping business in Pennsylvania, Ferrero Wastewater Management, and currently operates Elkhart Environmental Processing Corp. in Indiana, in addition to his half-time position with NAWT.

"Tom has always been a champion for our industry," Macchio said of Ferrero. "The (U.S. Environmental Protection Agency) respects our industry because of his representation." Macchio said Ferrero is among a



NAWT president Roger Winter (right) presents an award to past president Tom Frank.

"I will tell you five or six years ago, the EPA was ready to throw this industry away. They figured it was going to be utilities doing everything and (they could) manage a few utilities ... We've got them turned around on that, and they believe we have an industry that can step up to the plate and get the job done."

Tom Ferrero

number of NAWT members who have fought to bring greater reputation for professionalism to the industry, particularly in the eyes of government regulators.

Ferrero became NAWT's director five years ago, and has helped spearhead a Memorandum of Understanding working with several entities and has ramped up industry training opportunities.

"I will tell you five or six years ago, the EPA was ready to throw this industry away. They figured it was going to be utilities doing everything and (they could) manage a few utilities way better than a whole bunch of these pumper guys," Ferrero said.

"We've got them turned around on that, and they believe we have an industry that can step up to the plate and get the job done."

Frank works with his father, Tim Frank, in Ohio, and during his two years as president, he had to overcome a personal challenge when his family's disposal plant burned down. He is proud of the education initiatives NAWT instituted among service providers nationwide.

"We made some strides, and it's a tough push for our industry," Frank said. "We just keep pushing and plugging away and maybe eventually we'll get to the top of the hill some day." ■

**Contact us:** Pumper strives to serve the liquid waste industry with interesting and helpful stories. We welcome your comments, questions and column suggestions and promise a prompt reply to all reader contacts. Call 800/257-7222; fax 715/546-3786; e-mail Pumper editor Jim Kneiszel at [editor@pumper.com](mailto:editor@pumper.com).

# LELY

Commercial Wastehandling Equipment

## Put Our Experience to Work for You Aluminum Tanks • Full Open Door Hoist Tanks

### ASME DOT 407/412 Code Tanks

- Standard and custom tanks
- Carbon steel and aluminum available
- A tradition of reliable service
- Large range of sizes (400 - 6000 Gal.)
- Complete line of parts



- |            |             |
|------------|-------------|
| 1) [Image] | 9) [Image]  |
| 2) [Image] | 10) [Image] |
| 3) [Image] | 11) [Image] |
| 4) [Image] | 12) [Image] |
| 5) [Image] | 13) [Image] |
| 6) [Image] | 14) [Image] |
| 7) [Image] | 15) [Image] |
| 8) [Image] |             |

## Portable Toilet Trucks

### Available On All Models

- Hot Shift PTO with Automatic Transmission
- Balanced PTO Axle
- Heavy Duty Toilet Carrier
- Trailer Hitch
- Spring Rewind Reel (Optional Dual Service)
- 2" Bucket Quick Fill
- Driver Side Work Station



- Dual Side Tool Box
- Electric Water Pump 40 PSI 6 GPM (Air Pressurized)
- Coated Water Compartment
- Full Set of Working Lights
- Truck-Lite Lights
- 50 ft. Water Hose with Nozzle
- Vacuum and Pressure Relief Valve

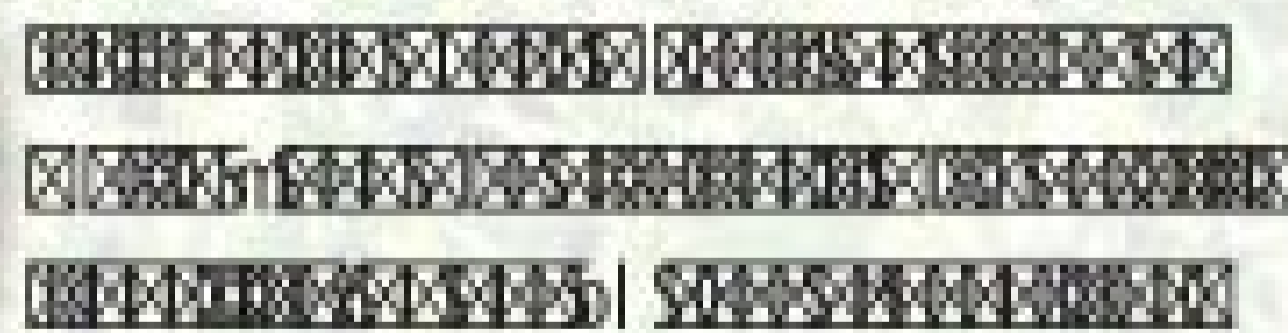
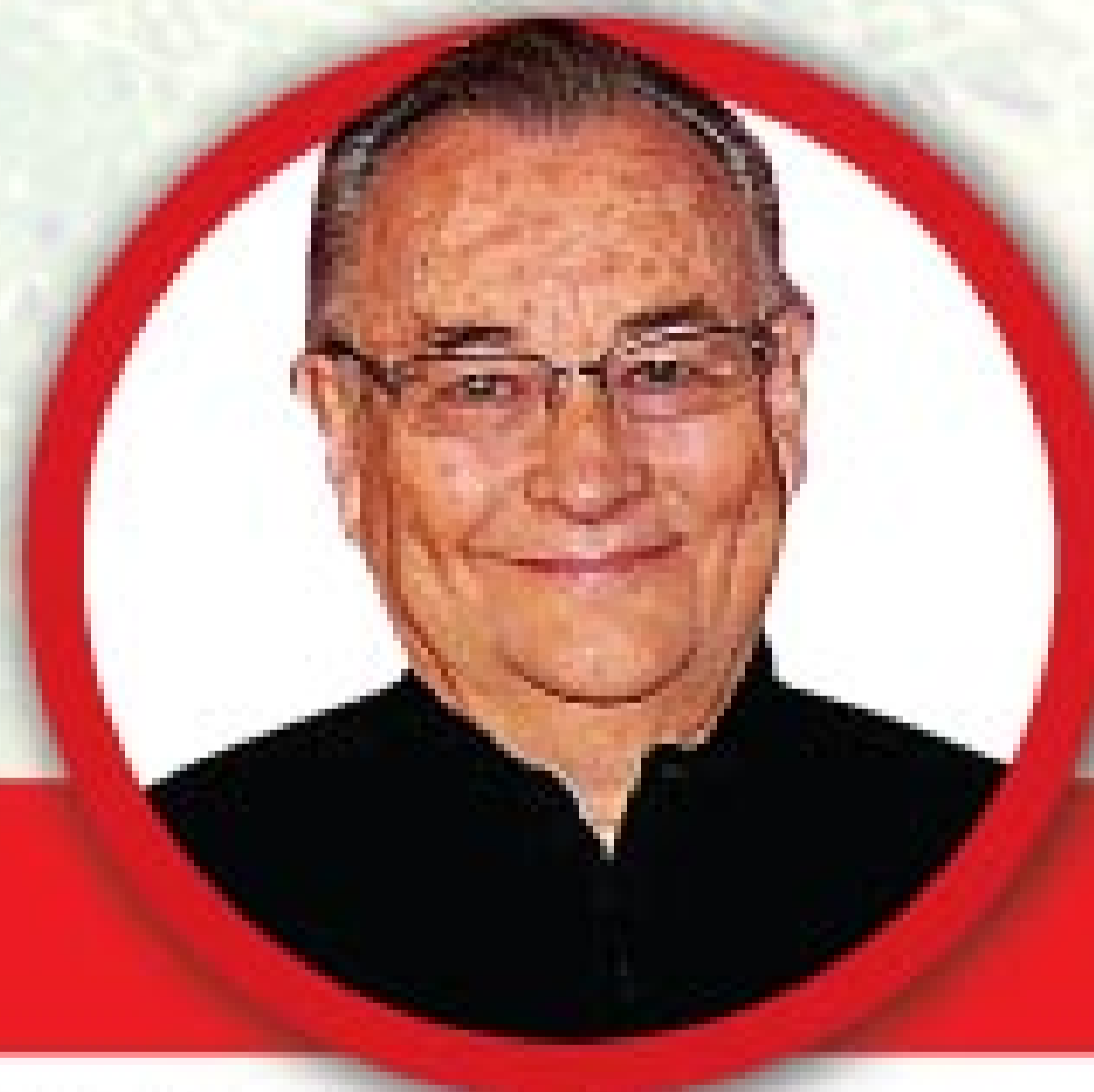

Lely Manufacturing, Inc.  
P.O. Box 789 Wilson, NC 27393  
**800.334.2763**  
sales@lelyus.com

—partners in wastehandling—  
**www.lelyus.com**

# We've Got You Covered

## Whatever you need in ground protection mats

With the acquisition of Mobile Mats, AltumaMATS now is able to offer the broadest line of ground protection mats in the industry...literally, we've got you covered. Now Mobile Mats will be available through AltumaMATS' and MobileMats' extensive dealer networks. All three mats leave soft turf smooth, even under heavy vehicle traffic and all are guaranteed for 6 years. No costly turf repair bills and NEVER GET STUCK AGAIN.



One-Piece Plastic  
**Outrigger Pads**  
Various sizes  
available!

AltumaMATS continues as the world's largest producer of quality ground protection mats.

**AltumaMATS**

sales@altumamats.com

Call for the name of your nearby dealer: 888-544-6287 [www.altumamats.com](http://www.altumamats.com)

### All Units Have:

- Steel Studs & Roof Rafters
- Fastenerless Siding No Screws Or Rivets
- Pull Them With SUV Or 1/2 Ton Pickup
- Hot Water
- AC and Heat
- 3 Year Warranty
- 24/7 Tech Support

See our website for more layouts and options.

6 Station  
600 Gal Waste Tank

4 Station  
450 Gal Waste Tank

2 Station  
300 Gal Waste Tank

*Comforts of Home*  
Services, Inc.

CALL FOR MORE INFO AND ADDITIONAL OPTIONS  
P: 877.382.2935  
EMAIL: INFO@COHSI.COM  
WWW.COHSI.COM



**We build the best for less, ask our customers!**



"I wanted to add an entry level trailer jetter to my Rooter Company that didn't cost an arm and a leg. I looked at the \$30,000 and \$40,000 units and couldn't justify it. I make money cleaning sewers not storm drains, so I did not need a monster machine or a glorified Cart Jetter on a trailer. After doing my homework, Hot Jet just made sense."

John - Rhinorooter, Brigham City, Utah

**LIMITED TIME SHOW SPECIAL**

**Xtreme Flow Cold Jetter**  
 ONLY \$14,995 List Price \$19,995  
Fully loaded

**Xtreme Flow Hot Jetter**  
 ONLY \$19,995 List Price \$24,995  
Fully loaded

Payments as low as  
**\$360.00**  
P.A.C.



Your choice of trailer color  Red  Black  Blue  Safety Yellow

**FREE**

**Warthog Nozzle and Monster Accessory Package:**

- 300 ft. 3/8 Jetter Hose
- Pressure gun assembly
- Turbo Nozzle
- Safety Cones
- Insulated Gloves
- Foot Valves
- Portable Hose Reel
- Vacuum Pump
- Tiger Tail Hose Saver
- Custom drilled nozzle set



Personalized Service  
 Best Warranty  
 Factory Direct Pricing

**Description**

- 4' x 10' Diamond Plate Steel Deck Trailer
- 35 HP VANGUARD Engine
- 325 gl. water tank with 2" fast drain
- Quick Antifreeze System
- Throttle Controls
- 8.5 GPM @ 3,600 PSI General Emperor Pump
- 12 volt variable speed high torque electric hose reel
- Foot pedal and ball valve water flow operation
- Jetting Pulsation Controls
- Pump Saver System
- **Easy to Service**
- **Extremely Easy to Operate**
- **Comes Fully Loaded**
- **Perfect Size to Clean 4" - 8" Drains**

**WE SPECIALIZE IN**

- Mid Size Jettors
- Enclosed Trailers
- Trailers
- Skid Plates
- Van Mount



Over 25 years of building quality equipment

**HotJetUSA**  
 DRAIN LINE JETTING EQUIPMENT®

**1-800-624-8186**

[www.hotjetusa.com](http://www.hotjetusa.com)

**chempace** corporation  
[www.chempace.com](http://www.chempace.com)

Serving the Industry for Over 40 Years!

One-Stop-Solutions For PORTABLE SANITATIONS & SEPTIC & GREASE HAULERS!

**BUYING DIRECT ALWAYS EQUALS COST SAVINGS**

CALL FOR MONTHLY SPECIALS!

**SEPTIC TANK ADDITIVES \$6 (Per Package)**

NEW PACKAGING OPTION

**Big Shot® Con2 & Con2 Plus**  
 • Super Strength Concentrate

NEW FORMULA!

ENHANCED FRAGRANCE!

STRONGER DYE

**Ultra PowerPak XL**

- Convenient Carry Pail
- Effervescence

**SUPER CHEMTAB \$90 (Per Case)**  
 New Special Pricing!

**BUY DIRECT CALL 800-423-5350**

**ERICKSON**  
 TANK & PUMP



TRI- AXLE SEPTIC PUMPERS

PORTABLE TOILET SERVICE TANKS



SINGLE AXLE SEPTIC PUMPERS

Check Our Web Site for Current Inventory!

**"Tanks" for your business!**

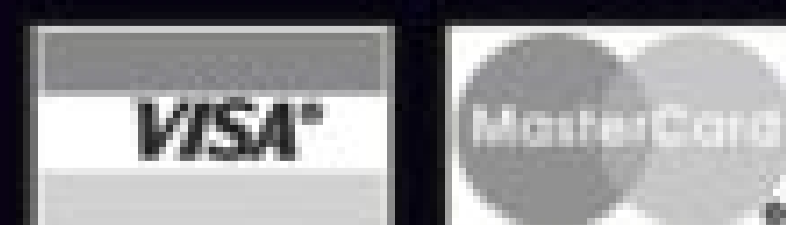

**509.785.2955**

[WWW.ERICKSONTANK.COM](http://WWW.ERICKSONTANK.COM)

# GET YOUR 2010 & 2011 PRE-EMISSION INTERNATIONALS WHILE YOU CAN!



## 2010 INTERNATIONAL 4400

**\$83,900.00**

US Funds – FOB Buffalo, NY  
Many options available. Detailed specifications on request.

- Maxxforce DT (260 Hp & 800 lb-ft)
- Fuller 6-speed
- 12,000 lb fronts & 21,000 lb rears
- Full-locking differential
- ABS air-brakes & Air conditioning
- 2500 US Gallon capacity
- TSI 250 vacuum pump (198 cfm)
- Full-length hose trays
- Heavy-duty stainless steel primary shut off
- Polished aluminum toolbox
- 20" top & rear manway
- Three (3) sight glasses or Sight tube
- 4" or 6" discharge & 3" intake



## 2010 INTERNATIONAL 7500

**\$106,900.00**

US Funds – FOB Buffalo, NY  
Many options available. Detailed specifications on request.

- Maxxforce 10 (350 Hp & 1150 lb-ft)
- Fuller 10-speed transmission
- 18,000 lb front & 40,000 lb rears
- Air ride susp., factory air conditioning
- Polished aluminum rims all around
- Full-locking differential
- 3600 US Gallon capacity
- TSI 500 pump (396 cfm)
- Two (2) 3/8" thick anti-surge baffles
- 20" top & rear man-way
- Heavy-duty stainless steel primary shut-off
- Polished aluminum toolbox
- 6" discharge & 4" intake
- Three (3) sight glasses or Sight tube
- Full-length hose trays



## 2011 INTERNATIONAL 5600 PAYSTAR

- Cummins ISX450 (450 Hp & 1650 lb-ft)  
2010 Pre-emission engine
- Fuller TRO-16908LL 10-speed transmission
- Engine Compression brake
- 20,000 pound fronts & 46,000 pound rears
- Air ride suspension, factory air conditioning
- Polished aluminum rims all around
- Full-locking differential
- 4200 US Gallon capacity
- NVE 506 vacuum pump (500cfm)
- Two (2) 3/8" thick anti-surge baffles
- 20" top & rear man-way
- Heavy-duty stainless steel primary shut-off
- Polished aluminum toolbox
- 6" discharge & 4" intake
- Three (3) sight glasses or Sight tube
- Full-length hose trays

**\$139,900 US FUNDS**

\* LIFT AXLE EXTRA

WE PAY BORDER CROSSING CHARGES • LEASING? WE CAN REFER YOU TO THE SPECIALISTS • OVER 40 YEARS IN BUSINESS

**TRANSWAY**  
SYSTEMS INC.  
PROFESSIONAL VACUUM EQUIPMENT

progress tank  
DISTRIBUTOR

[www.transwaysystems.com](http://www.transwaysystems.com)

Toll-Free 800-263-4508

Tel. (905) 578-1000

Fax (905) 561-9176

DELIVERY SERVICE  
AVAILABLE

314 Lake Ave. North  
Hamilton, Ontario L8E 3A2



**NEW PRODUCT!**

**MAGNUM 600**



**PLEASE CONTACT US FOR YOUR NEAREST AUTHORIZED DISTRIBUTOR**

**DEALER INQUIRIES WELCOME**



**1-877-837-7323      www.nuhn.ca      nuhnind@nuhn.ca**

# WORKMATE PRODUCTS

A Division of FMI Truck Sales & Service

**PORTABLE TOILET TRUCKS ♦ SEPTIC SERVICE TRUCKS ♦ TOILET & SERVICE TRAILERS**

**NEW Field Sanitation Service Trailer**



**www.fmitrucks.com ♦ 1-800-927-8750 ♦ John Barrett ♦ Portland, Oregon**

# TOP LINE

## Top Line Accessories



**Hand Wash**



**Fresh Water Flush**

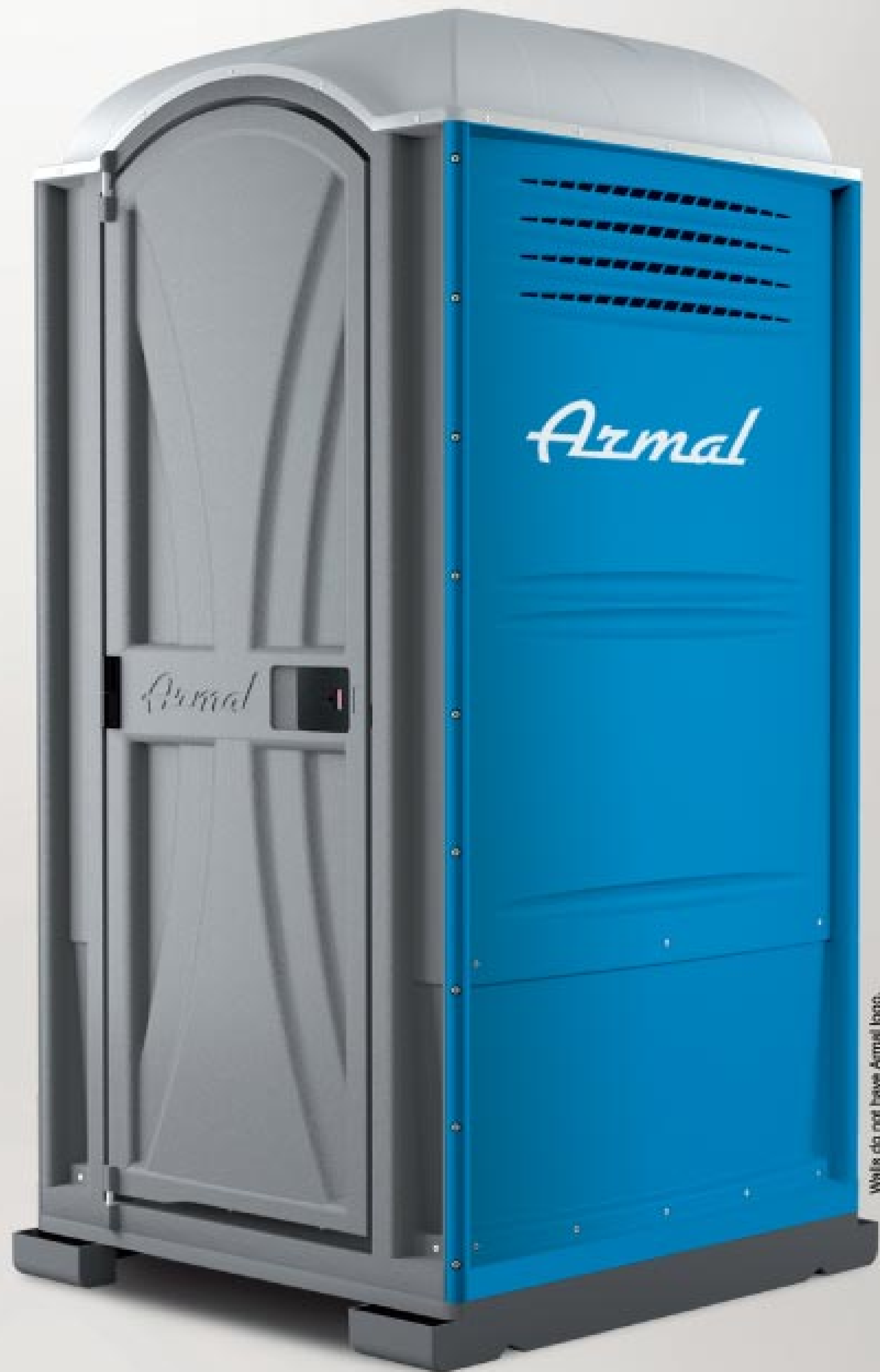

LEONES

Walls do not have Armal logo.

# Armal

[www.armal.biz](http://www.armal.biz)

Armal Inc. 122 Hudson Industrial Drive, Griffin, GA 30224 - USA  
Phone 770 491 6410 - Fax 770 491 9458 - Toll Free 866 873 7796  
[armal-inc@armal.biz](mailto:armal-inc@armal.biz)

# ADAPT & OVERCOME

Technician Daniel Gonzalez removes graffiti from a pink women-only restroom at Sani-Hut in Nevada. (Photos by Lisa J. Tolda)

**Nevada's Sani-Hut employs careful management practices and new technologies to weather 50 years of economic ups and downs**

*By Marian Bond*

In Northern Nevada, *Sani-Hut* is nearly synonymous with *portable restroom*, like *Kleenex* is to *tissue*. And the name recognition the Sani-Hut Company Inc. enjoys is sometimes an issue for competitors, who get calls from potential clients asking about renting a Sani-Hut.

The company's reputation has grown with this burgeoning area. In 1956, when Fred Cutler Sr. bought a two-year-old portable sanitation company, the industry was in its infancy and so was the sparsely populated desert region. But today, Sani-Hut serves the vibrant Reno-Sparks area with a population base of more than 400,000.

And while Sani-Hut has expanded the scope of its offerings, portable sanitation — and the company's distinctive pink and blue units — has always dominated the business. They also provide a variety of temporary site services and manufacture related equipment. In 1972, leadership was turned over to Fred

Cutler Jr. The elder Cutler died in 2007.

There have been challenges along the way, most recently the economic recession that dropped construction-related accounts from 70 percent of the business to almost zero. Not unlike many businesses, Sani-Hut has had to cut its workforce, from 50 employees two years ago to 25 today. The company has put other cost-saving measures in place to preserve the business for brighter days ahead.

*Pumper* visited with Cutler Jr. in 1988 for a contractor profile story and decided to return 22 years later to learn how the company has changed and adapted to new technologies and ways of doing business.

## DIVERSIFICATION & COST CONTROL

In this period of economic upheaval, Cutler reports that diversification has been helpful. "We can keep our heads above water





## Profile

### Sani-Hut Company Inc. Sparks, Nev.

Owner: **Fred Cutler**

Years in business: **54**

Employees: **25**

Services: **Portable sanitation, power pole sales, manufacture of office trailers, storage buildings, guard shacks, temporary power**

Area served: **Reno, Sparks, Lake Tahoe, Carson City and surrounding communities**

Customers: **Construction, special events, private parties**

Web site: **www.sanihut.com**

Associations: **Portable Sanitation Association International**



NEVADA



Yard technician Daniel Gonzalez loads a restroom for delivery with the help of Sani-Hut customer service manager Ralph Jarmin.

**“EVERYBODY HAS COMPETITION. I DON’T MIND COMPETITION. I JUST WISH OTHERS HAD A BETTER SENSE ABOUT WHAT THEY ARE DOING. YOU CAN’T GIVE THIS SERVICE AWAY. THERE IS AN OLD SAYING: ‘I WOULD RATHER HAVE 50 RESTROOMS OUT AT \$100 A MONTH, THAN 100 RESTROOMS AT \$50 A MONTH.’ ”**

**Fred Cutler**

and keep people working,” he says.

Over the years, Sani-Hut has expanded to offer a variety of products and services, including manufacturing guard shacks, storage buildings, portable office buildings, safety barriers and shower trailers. Enhanced services include providing holding tanks, temporary power and trash management. Another service is site cleanup, sorting plastics for recycling.

Early on, the company installed a legally permitted dump station at its yard, which connects to the city sewer. Here they have their truck-wash rack so vehicles can be cleaned while dumping waste.

Along with building revenues through diversified services and products, Cutler is

implementing thorough cost-control measures in response to the flagging construction trade.

“We’re cutting costs,” Cutler says. “Everybody who works here has appreciated what we are trying to do. The (workers) in the office have cut back on their hours to help keep us going. Same with the drivers.”

Other measures include parking 12 vehicles on the back of the yard, saving on insurance and licenses, cutting power usage in the building, monitoring cell phone bills and

watching for waste in consumables used in restroom service.

#### QUALITY SERVICE RULES

But Cutler won’t sacrifice service quality in the name of saving money. He conducts spot checks on a job to be sure things are going well. He holds a drivers’ meeting every three weeks, always pushing customer service and assuring his employees that if there is a problem, he wants to know about it.

“In this business, it is consistency,” Cutler says. “We always have to be there to take care of the restroom.”

He wishes competitors would always set the same goal of providing consistent service and better understand the true cost of providing quality service. Cutler says customers become unhappy when they don’t receive the service they are paying for, and this reflects on everyone in the industry. He uses weekly service provided for a base price as an example. If a contractor’s promised Monday service stretches to Tuesday or beyond as a way to control costs, the customer is not getting what was initially promised.

Sani-Hut owner Fred Cutler (below) walks the company’s yard in Sparks, Nev., with constant canine companions Ruby and Molly. Below right, Cutler in the office with staff (from left) Terry Tholl, Linda Martinez, Roberta Keller, Lisa Strasser and Ralph Jarmin.





Worker Daniel Gonzalez cleans sinks in the Sani-Hut yard.



Employee Wayne Burton rolls up a carpet for cleaning in a restroom trailer.

“We service once a week as a base price,” Cutler says, adding that Sani-Hut sticks to its schedule and bills on a 28-day cycle. “Everybody has competition. I don’t mind competition. I just wish others had a better sense about what they are doing. You can’t give this service away. There is an old saying: ‘I would rather have 50 restrooms out at \$100 a month, than 100 restrooms at \$50 a month.’”

In response to consistent service over the years, the community has been loyal to Sani-Hut, particularly on the special event side of the business. The company serves many major events in Reno, such as the National Championship Air Races and Air Show, which

draws more than 200,000 spectators, the Reno Rodeo, with 140,000 fans and Hot August Nights, with 800,000 visitors.

Cutler says his customers know what they want. “While some people are looking for price, others appreciate the service and the quality, and we always keep in touch. We let them know we appreciate the business. We send thank-you cards, and give gratitude packages (pencils, business card holders and the like). We have always put so much of ourselves back into the community with food drives and other activities.”

#### INVENTORY AND FLEET

While Cutler won’t share specific restroom inventory numbers, he says they have a few thousand at one site, and many more at the storage yard. Their units currently come from

PolyJohn Enterprises Corp., although in the early stages of the business Sani-Hut did some manufacturing of its own.

Cutler prefers to use PolyJohn’s Fleet model as a standard restroom. For handicap units, he likes both the larger ADA-compliant We’ll Care III and the wheelchair-accessible Comfort Inn models. PolyJohn provides the hand-wash stations, too, including the Bravo and Applause models. PolyJohn hand sanitizers are included in every unit. They also offer the stand-alone SaniStand model. Special event trailers come from Advanced Containment Systems Inc.

As for managing restroom inventory, new units are set aside for special events, and those in service for a while are moved to construction sites. Cutler says he gets up to 15 years of use out of a restroom. The company processes and recycles plastic materials, which it sells to a company in Arizona.

For service vehicles, Cutler prefers International DT466 powerplants. The com-



Technician Melvin White (above) returns a hose after cleaning a restroom at the Reno-Tahoe International Airport. At right, head mechanic Ty Denny runs diagnostics on one of the fleet of vacuum trucks at Sani-Hut.



# 'Dirty Jobs' Media Experience is Positive

When Sani-Hut's Customer Service Manager Ralph Jarmin appeared on KTVN Channel 2 News in Reno for a local "Dirty Jobs" series that aired last fall, the reaction was positive and the feature put the industry in a good light according to Jarmin.

"We had calls from people in the business," he says. "We heard from Barry Gump (of Andy Gump), and we had calls from people in town saying we had done a good job."

Sani-Hut was contacted by reporter Jen Jackson, who was doing a series on dirty jobs, a play off the Discovery Channel's popular Dirty Jobs series, and she wanted to know more about the process of cleaning a portable restroom.

Jarmin met Jackson and her camera crew at the site of one of its units, and, putting on gloves, explained that although people have the impression this is a "dirty job," he would not get his hands dirty in the process. While the camera rolled, Jarmin cleaned the restroom as the reporter watched. Jackson then took a turn at cleaning.

Jarmin says he would encourage others in the industry to consider answering the call if local media contacts them for similar projects.

"When a story like this goes out, people learn for themselves that this is not what they expected to see. They think this is a terrible, filthy job, but it's not," he says. "I would advise anyone in the industry to contact the local media with the idea of doing an interview or article to give people a better understanding of what we are all about. With our story, we really put the industry in a good light."

Check out the report at [www.ktvn.com/Global/story.asp?S=11481561](http://www.ktvn.com/Global/story.asp?S=11481561)

**"I'M A BIG BELIEVER IN OIL CHANGES TO GET THE LIFE OUT OF THE EQUIPMENT. I'VE GOT A 1990 INTERNATIONAL AND A 2001 INTERNATIONAL. IF THAT 2001 STARTS COSTING ME MONEY, I WILL GET RID OF IT AND KEEP USING THE 1990. WE KNOW EXACTLY WHAT A PIECE OF EQUIPMENT IS COSTING."**

**Fred Cutler**



Employee Ralph Jarmin empties a load at the company's on-site dump station.

Pumper first profiled the company. Today, Sani-Hut uses MAS 90 ERP software from global software provider Sage North America. Linda Martinez, Sani-Hut office manager, says the program is designed specifically for the rental industry and handles many of the company's office tasks.

## A LEGACY OF INDUSTRY INVOLVEMENT

Cutler Sr. was a charter member of the Portable Sanitation Association International, and in 1995 he received the M.Z. Andy Gump Distinguished Service Award. Cutler Jr. follows in the path of his father as a PSAI member. He is currently helping to rewrite a book-

let of guidelines for PSAI members, which he describes as a powerful tool to promote working with local health departments, special event organizers and the construction industry to provide enhanced services.

Over many years in the industry, Cutler credits contractors with a "thirst for knowledge" for the tremendous advancements in service, cleanliness and technology. He says hardworking people in the industry have always shown an interest in seeking better service techniques and equipment, and that networking has stretched across the nation, to Europe and beyond.

"Sometimes we look at things and have blinders on, then you brainstorm with someone and you get better ideas," he says. "It's all about people talking with others in the industry."

### MORE INFO:

**Advanced Containment Systems Inc.**  
800/927-2271  
[www.acsi-us.com](http://www.acsi-us.com)

**Masport Inc.**  
800/228-4510  
[www.masportpump.com](http://www.masportpump.com)

**PolyJohn Enterprises**  
800/292-1305  
[www.polyjohn.com](http://www.polyjohn.com)

pany builds all its own trucks.

"I'm a big believer in oil changes to get the life out of the equipment," he says. "I've got a 1990 International and a 2001 International. If that 2001 starts costing me money, I will get rid of it and keep using the 1990. We know exactly what a piece of equipment is costing."

Cutler has about 18 service and delivery trucks in the fleet. The smaller trucks are GMC W4500 models, some with 550-gallon waste/300-gallon freshwater steel tanks. Larger trucks utilize 1,000- to 1,200-gallon waste and 500-gallon freshwater tanks with International chassis. The company also has a 5,000-gallon tank trailer for large loads. All have Masport pumps. For his service rigs, Cutler prefers an automatic transmission.

"You don't have to worry about clutches and how the truck is driven," he says. "You get more life out of a vehicle with an automatic transmission."

## FORWARD THINKING

Cutler noted some of the changes in the industry that make it easier to quickly respond to customer needs and have speeded up workflow in a more demanding business climate. Sani-Hut previously utilized printed promotional materials, particularly brochures and catalogs to illustrate its products. The money once spent on printing has been redirected to the company Web site. In a conversation with a client, Cutler can refer to Web pages with photos of items the customer is looking for.

"You still need a telephone book ad, but we have cut those back," he says. "Our clients are using the Internet, and we are putting a lot of focus on photos and information that is easy to find."

As for recordkeeping, Sani-Hut was using an Adler Disc Textwriter for some delivery tickets, invoicing and other tasks when

For 30 years, V.E. Enterprises has been building liquid storage trailers and tanks for leading environmental, waste management, construction and energy service companies for a reason: customers value **experience**.

Experience alone isn't enough to stay competitive in this global economy. It takes a world-class facility, state of the art equipment and ASME certified welders to manufacture products that are the highest **quality**.

Maintaining top quality doesn't always guarantee customers will keep coming back. It takes a company that stands with its customers - listening, thinking and responding with the next breakthrough storage design - that's **innovation**. That's V.E. Enterprises.



**experience • quality • innovation**

*Setting the Standard For Liquid Storage  
and Transports Since 1987*

800.234.2329  
sales@veenterprises.com  
www.veenterprises.com

**VE**  
**ENTERPRISES, INC.**



TANKS SHIPPED TO YOUR LOCATION



STAINLESS STEEL & STEEL UNITS -  
CALL FOR INFORMATION



TANKS BUILT TO YOUR DESIGN

## PUMP DISTRIBUTOR

- \* BATTIONI
- \* JUROP
- \* BOWIE
- \* MASPORT
- \* FRUITLAND
- \* MORO

**Pump Rebuild Kits In Stock**

**CALL TODAY FOR  
INFORMATION  
OR PRICES ON  
TANKS, PUMPS  
AND ALL PARTS**

Secondary Shutoffs

Sight Glasses, Valves & Couplings

12" Primary Shutoffs

21" & 36" Manways

### BASE TANKS INCLUDE:

1/4" Thick Steel • Pipe Reinforced Baffles • Primary Shutoff  
Flanged and Dished Heads • 21" Top and Rear Hatches  
Full Length Under Carriage on Bottom of Tank

#### BASE TANK PRICING

2100 GALLON .....	\$5800	3360 GALLON .....	\$8140
2500 GALLON .....	\$6740	3570 GALLON .....	\$9000
3000 GALLON .....	\$7575	4000 GALLON .....	\$9920

**Specialty B  
SALES**

**800.364.7307**

2100 EAST BOOTH ST. • SEARCY, AR 72143  
Fax: 501.279.0003 • E-mail: sbs@cdlworld.net

You're looking at the  
**BEST vacuum tank in the industry,**  
 ... and the **guys who guarantee it!**

see us on

**You Tube**

**twitter**

**Linked in**



**AMTHOR STEEL MATADOR FLAT VAC PORTABLE TOILET UNIT**

Brian Amthor, Butch Amthor and Hank Vanderveen



- Full line of septic and round and flat portable restroom vacuum tanks. Available in aluminum, steel or stainless steel. Dumping and ASME options.
- Thickest vacuum tanks in the industry. No external rings and full head baffles.
- Units in stock and ready for immediate delivery.
- In house financing - numerous options, competitive rates.
- 10 year leak free warranty on all of our aluminum vacuum tanks.
- Work directly with the factory that manufactures and assembles each unit.
- Worldwide distribution, American made, family owned.



**Engine and Accessory** (states in red)  
 Miami, FL • (800) 327-5431 • ask for Craig Smith



**Amthor Welding** (states in blue)  
 Gardiner, NY • (800) 926-8467 • ask for Brian Amthor



**Amthor International** (states in gold)  
 Gretna, VA • (252) 293-1284 • cell: (845) 494-0104  
 ask for Hank Vanderveen



Gretna, VA • tel: 800.328.6633 [www.AmthorInternational.com](http://www.AmthorInternational.com) Amthor: Built for the Miles Ahead



# The New Way For Grease Disposal

*Does your customer have one?*



Order with or without the containment and save cost

The Outdoor Envirotub is environmentally friendly and made from 100% recycled materials. Lightweight for easy movement. Stores up to 1,200 pounds of grease. Non-stick plastic surface for easy cleaning and eliminates grease build up. Self closing lid to reduce odors and rain water. Built in containment, catches overflow, spills, perfect for coastal communities. Keeps trash areas clean, endorsed by property management and restaurant companies.



The indoor tub made to keep grease thieves away. Stores up to 55 gallons of grease. Fits under most two and three compartment sinks. Perfect for small kitchens with limited space, malls, colleges and food courts.

- > Self Closing Lid
- > Full Containment
- > 100% Recycled Plastic
- > Easily movable

## ENVIROTUB

[www.envirotub.com](http://www.envirotub.com)

PO BOX 1343, CORONA, CA 92878

**1.866.777.4322**

## WILCOX TRUCK SALES, INC.



Lowell, Arkansas

SINCE 1978

I-540 Exit #78 & Hwy 71B

2 hours East of Tulsa or 1.5 hours South of Joplin

Toll Free 888-207-2074 Fax (479) 770-6089 [www.wilcoxtrucksales.com](http://www.wilcoxtrucksales.com)

### 1997 Mack RD685S



3,650 Gallon Tank, Jurop Vac Pump, Mack, 13 Speed, 400 HP, Camelback, Tri-Axle, A/C, **\$41,200**

### SafeJetVac Model AJ1015



Fantastic Unit. Ready To Go On The Job & Make Lots Of Money. Allison Automatic With Breakout Power Tower. No Auxiliary Engine To Start. 10 Yard Debris. 1500 Gallon Fresh Water, 80 GPM @ 2,000 PSI. City Owners. **\$82,200**

### 2002 Mack CH613



One Owner, New 80 Barrel Vacuum Tank, New Jurop R260 Pump, New Timbren Suspension Enhancement, 427 HP, 9 Speed, Jake Brake, 597k Miles, Excellent 24.5 Radials On Polished Alcoa's. **\$61,200**

### 1999 Paystar



20k Front Axle, 46 Rear, Full Cross Diff Lock, 192k Miles, New 90 or 100 Barrel Vac Tanks, New R260 Jurop Pump, **\$62,250**

### 2001 Peterbilt 379



Ex-Hood, 500 HP, Triaxle, 100 Barrel, 4200 Gallon Tank, File Photo **\$74,500**

## We've Got the Money!

*...And We Are Here For You.*

- New & Used Equipment
- Exceptional Customer Service
- Flexible Payment Options
- Dedicated to Finding You Our Best Available Rates



Chuck Territo

*"THE SOLUTION TO ALL YOUR FINANCING NEEDS."*

## Granite Leasing Co.

406-892-5068 • 800-246-7997

[chuck@graniteleasing.com](mailto:chuck@graniteleasing.com) • [www.graniteleasing.com](http://www.graniteleasing.com)

# HOW DO YOU LIKE YOUR SAVINGS? WET OR DRY?



## SAVE \$\$\$\$\$ ON DEODORIZERS IN EXCLUSIVE FRAGRANCES

Our Fragrance of the Month discount deodorizer program offers you a choice – either BlueWorks, our most powerful liquid deodorizer; or DriPax, our new water soluble, portion-controlled product. It's your choice and the savings are BIG! Just call **Cindy** at **(800)241-7951** or your PolyPortables division manager for details.

All purchases from Green Way Products qualify for Blue Bucks. Like money in your pocket, Blue Bucks spend like cash on PolyPortables or Green Way Products.



99 Crafton Drive, Dahlonega, GA 30533 USA • Phone (800) 241-7951 or (706) 864-3776 • Fax (706) 864-8111 • [www.polyportables.com](http://www.polyportables.com)

Only PolyPortables offers high-performance Green Way Products

TOILET DEODORIZERS • TOILET CLEANERS • AIR FRESHENERS

All Green Way deodorizers, cleaners and air fresheners are earth-friendly, people-friendly products. They are developed and manufactured in our facilities in Dahlonega, Georgia by Green Way Products, a PolyPortables sister company.



# Seasons Change - Dedication Doesn't

- *Stainless Steel*
- *Aluminum*
- *Code & Non-Code*



7,150-GALLON ALUMINUM  
DOT-412 VACUUM DUMPER



45 Years of Manufacturing Experience

*Manufacturing*

*Vacuum Trailers for the  
Liquid Transportation Industry*

Parts • Repair • Complete Pumping Systems

# 800-589-5254

www.acrotrailer.com • 417.862.1758 • fax 417.862.8084 • 2320 North Packer Road • Springfield, Missouri 65803



## The New Model SK4018DT

4000 psi,  
18 gpm  
Hydraulic Reel  
66 h.p. Diesel



See our complete lineup including Hot Water models,  
van mounts, portables and more on the web at:

**www.camspray.com**      **800-648-5011**

# Pump! Save! Earn!

With **PRO-PUMP**

The Finest Name in Biological Products for Septic Systems,  
System Recovery, Odor Elimination and More...



- Septic System Treatment
- Absorption System Recovery
- Aerobic System Treatment
- Drain & Grease Traps
- Solids Reduction
- Odor Control
- Bio-remediation

**Our 33rd Year!**

**Call Greg Toll Free at 1-800-326-7867 and ask  
about our Special Discounts & Free Freight!**

*Solving Problems, Naturally!*

**Ecological Laboratories INC.**

TOLL FREE: 1-800-326-7867 • FAX: 516-823-3440 • EMAIL: info@propump.com

Visit our web site at: [www.propump.com](http://www.propump.com)



ORDER AS MUCH AS YOU WANT FOR ONE LOW PRICE - OFFER ENDS 5/15/10

\* Restrictions Apply

**OVERSTOCK SALE!**

7 LEFT AT THIS PRICE!!

20" MANWAY - 6 WINGNUTS



~~\$262.95~~

**\$199**



**JUROP- WE GOT EM!!**

**FROM \$1095**

LEVER VALVES

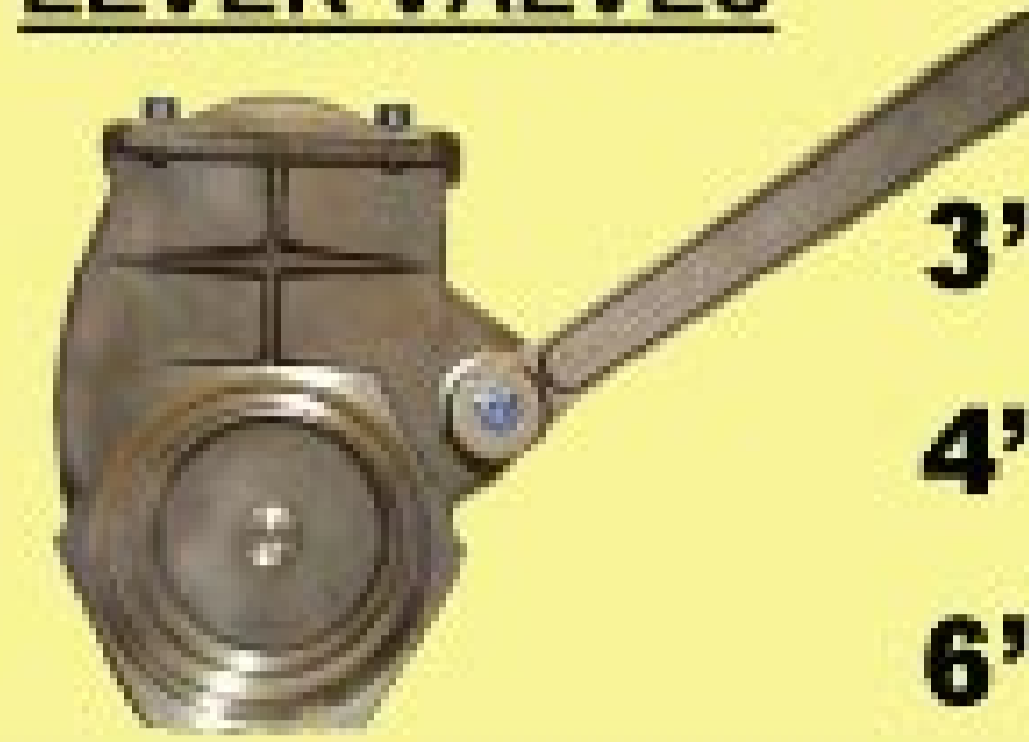

3" **\$89**

4" **\$125**

6" **\$239**

**OVERSTOCK SALE!**

**COMPLETE BATTIONI BOLT AND GO!!**

**MEC 11000 MAX PACK**

Everything you need- no welding. Assembled right here in the USA by the people who build Challenger- just bolt it up and Go!!

Includes:

- 394 CFM Continuous Duty Pump, Secondary, Final Filter, Muffler Pump Stand, Gear Box Pump Coupling, gauge and valves

**\$4400**

EPDM SUCTION CPLD M X F QUICK CONNECT



GET IT IN COLORS SAME LOW PRICE

INCLUDES FITTINGS!

3" X 20' ~~\$87.00~~ **\$79.95**

3" X 25' ~~\$95.00~~ **\$92.89**

3" X 30' ~~\$114.00~~ **\$108.95**

3" X 33' ~~\$123.00~~ **\$117.89**

PORTA -TUFF HOSE **NEW PORTABLE TOILET HOSE!**

*A Varco Exclusive!*



**OVERSTOCK SALE!**

2" X 25' **\$84.95**

2" X 30' **\$99.95**

2" X 35' **\$117.95**

2" X 40' **\$142.20**

- NO CUFFS!
- 100 FT LGTHS
- EASY REPAIR!
- MOST FLEXIBLE HOSE WE HAVE!

TIGER TAIL CPLD M X F QUICK CONNECT



INCLUDES FITTINGS!

2" X 25' ~~\$96.75~~ **\$91.70**

2" X 30' ~~\$113.00~~ **\$108.70**

2" X 35' ~~\$129.75~~ **\$125.45**

2" X 40' ~~\$145.50~~ **\$142.20**

**OUR BRAND NEW LINE OF PUMPS- GREAT PUMPS AT A GREAT PRICE!**

BATTIONI 1 YEAR WARRANTY MEC 11000

**394 CFM! CONTINUOUS DUTY!**



**\$2225**

BATTIONI #1 SELLING PUMP! MEC 8000

**285 CFM!**



**\$1645**

BATTIONI MEC 2000

**90 CFM!**



**\$1095**

**BUY BULK AND SAVE!**

EPDM SUCTION BULK 100 FT ROLLS



GET IT IN COLORS SAME LOW PRICE

2" 3" 4" 6"

\$2.19 \$3.69 \$6.59 \$11.35

**\$1.69 \$2.85 \$5.25 \$10.95**

SAVE MONEY- PROTECT YOUR FITTINGS!

SAFETY LOCK



2" **\$1.65**

3" **\$1.95**

4" **\$2.50**

SAFETY BUMPS

COMFORTABLE HANDLE SAFEGUARDS YOUR FITTINGS

2" **\$16.25** MXF SET

3" **\$25.95** MXF SET

4" **\$33.75** MXF SET

COUPLINGS AND REDUCERS



**100'S OF THEM!**



FEMALE X MALE REDUCER



3" X 2" **\$17.85**

4" X 3" **\$24.50**

6" X 4" **\$42.95**

**VAC TRUCK ACCESSORIES**

2" OR 3" PRIMARY



2" **\$159.95**

3" **\$159.95**

1 1/2" BRASS VACUUM RELIEF



**\$20.95**

BRASS PRESSURE VALVE



1 1/4" **\$24.95**

1 1/2" **\$28.95**

2" **\$36.95**

VACUUM PRESSURE GAUGE



2.5" Face **\$13.95**

4" Face **\$40.95**

- 0-30 Vacuum
- 0-30 PSI
- Liquid Filled
- 1/4" Male NPT

2" OR 3" SECONDARY



2" **\$157.95**

3" **\$215.95**

HOSE BREAKING OFF AT TRUCK? YOUR CHOICE SAME PRICE

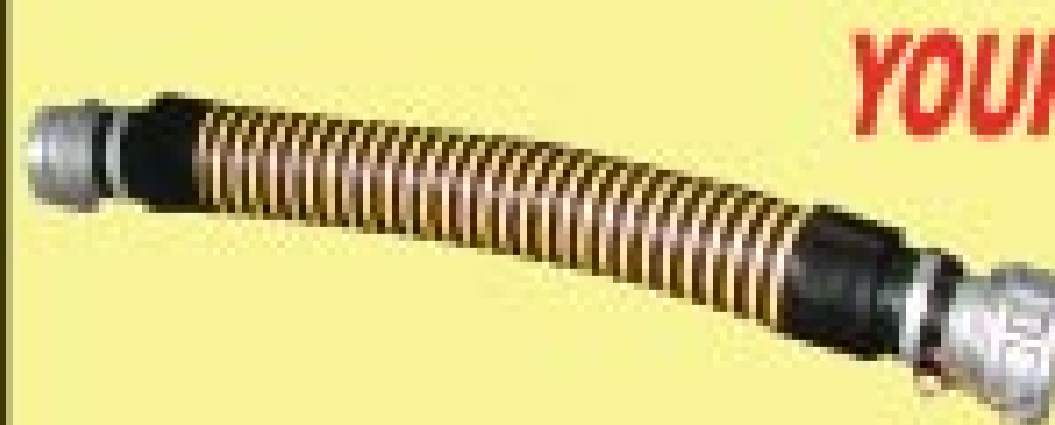

VARCO FLEXI-JOINT

3"

**\$51.99**

4"

**\$65.99**



VARCO TUFF-JOINT

SLUDGE HOE



**\$62.50**

SCRAPERS



from **\$50.00**

SPOONS

Includes Fiberglass Handle!

from **\$105**

**FREE CATALOG**



**SHOP ONLINE AT WWW.VARCOPUMPER.COM**

NOW OPEN 24 HOURS A DAY/ 7 DAYS A WEEK

TOLL FREE

**866-872-1224**

SOURCE KEY 4P10



# 332 SYSTEMS SAVED THIS YEAR...SO FAR!

THAT'S RIGHT, SINCE WE INTRODUCED AFTERSHOCK  
BIOREMEDIATION RESTORATIVE AT THE 2009 PUMPER  
& CLEANER ENVIRONMENTAL EXPO IN LOUISVILLE,

## 332 SYSTEMS HAVE BEEN RESTORED

BY THE OXYGEN-ENHANCED  
BACTERIA IN AFTERSHOCK.

### SINGLE DAY BIOREMEDIATION PROCESS!

Unlike all other oxidizing products, **AfterShock's** consortium of bacteria and oxidizer can be applied **at the same time**. The oxygen-accelerated bacterial action will quickly digest the organic solid materials that reduce the drain field's capacity to absorb water, effectively restoring drainage through a natural process. The bacteria contained in **AfterShock** are authorized by the USDA, and have been treating septic systems around the world since 1976.



To learn more about this revolutionary approach to restoring drainage as well as our entire line of state-of-the-art products for residential and commercial septic system treatment, grease waste systems, and for bioremediation, please call us toll-free at 1-800-759-2257 to request our product information package. Or log on to [www.SepticOnline.com](http://www.SepticOnline.com). There is no cost or obligation, and no obnoxious salesman will call you (a big plus with us).

If you've waited to get involved with bioremediation because the process is so tedious and time-consuming, now is the time to start. Do it all in ONE TREATMENT. Please call today. Thank you.  
- Rick Howe, President

GREEN PRODUCTS FOR SEPTIC PROFESSIONALS SINCE 1976

### CAPE COD BIOCHEMICAL COMPANY

P.O. Box 990 • Pocasset, MA 02559

**1-800-759-CCLS**  
(1-800-759-2257)

FAX: 508-564-9974 • [www.SepticOnline.com](http://www.SepticOnline.com)

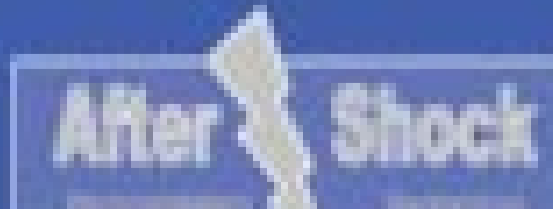

# BACK HURTING

FROM PUMPING SEPTICS OR GREASE TRAPS?

**END THE PAIN!**



The Ultimate hand-held,  
powered agitator for septic  
tanks, grease traps and  
car wash pits

[WWW.CRUSTBUSTERS.COM](http://WWW.CRUSTBUSTERS.COM) • 888.878.2296

Schmitz Brothers L.L.C.

PHONE 763.878.2296

FAX 763.878.2299

ASK ABOUT OUR  
"BUSTER BRACKET"  
FOR TRUCK MOUNTING

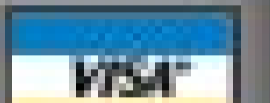

# ABERNETHY 1.800.545.0324

[abernethyinc@charterinternet.com](mailto:abernethyinc@charterinternet.com)

WELDING & REPAIR INC.

Financing Available



2010 International 4400E Series,  
260 hp diesel DT 466 engine, 6-spd. trans. and  
world class auto, air brakes, 33,000 GVW,  
A/C, 2500 gal. tank, Masport HXL400 pump  
Also, 2500 and 3500 gal. tanks

### PORTABLE TOILET UNITS:

- 2007 Chevrolet 5500 - Call for prices.
- 2004 Chevrolet 3500 - Flat bed, lift gate, Portable Restroom Hauler
- 1999 Internat'l 4700 - 1100/400 gal. tank, good condition
- 1999 Sterling - 1500 gal.
- 1997 Ford F450 - 800 gal. tank
- 1995 UD - 1000 gal. tank

### SEVERAL GOOD, OLDER TRUCKS TO CHOOSE FROM:

- 1999 Volvo - 5000 gal. tank, 350 cfm pump
- 1998 Volvo - 4000 gal. tank, 350 cfm pump
- 1995 Chevrolet - 1 800 gal. tank, gas, under CDL
- 1995 International - 2200 gal. tank
- 1991 Chevrolet - 2500 gal. tank
- 1990 Chevrolet - 2000 gal. tank

**MANY OTHER UNITS IN STOCK!  
CALL FOR UPDATE**

### Ford • GM • International

2010 INTERNATIONAL

2500 gal. tank

2010 PETERBILT

2500 gal. tank

2009 KENWORTH

2500 gal. tank, Wallenstein pump, 6-spd, 260 hp

### NEW PORTABLE TOILET UNITS:

2008 KENWORTH

1500 gal. portable toilet service unit, auto trans.

3-2009 INTERNATIONAL 4300

1500 gal. portable toilet service units, auto trans.

**WE WILL CUSTOM BUILD YOUR  
TANK UP TO 5000 GALLONS!**

600-1500 Gallon Portable Toilet Trucks:  
Our Truck or Yours



**TRUCK REFURBISHING AVAILABLE**

COMPLETE PARTS AND IN-HOUSE SERVICE

[www.abernethywelding.com](http://www.abernethywelding.com)



# BUSINESS BROKERAGE

powered by: **Pumper**

## Marketing & Brokering Liquid Waste Businesses

### TRYING TO SELL YOUR BUSINESS?

We can effectively market your business to more than 60,000 potential buyers in the liquid waste industry, your local markets, and other venues. No upfront fees – you don't pay anything unless your business sells. To learn more about brokering your business through B<sup>2</sup>, call 800-257-7222.

### LOOKING TO BUY?

Call us, and we can add you  
to our VIP Buyer List

**(800) 257-7222**



# IN GOOD HANDS

Volunteers are trained and knowledgeable in the handling and disposal of hazardous waste. They are also trained in the use of personal protective equipment (PPE) and safety procedures.



## Featured in an article?

# Make the most of it!

### REPRINTS AVAILABLE

- We offer:
- Full copies of the original magazine
- Hard copy color reprints
- Electronic reprints

Visit [pumper.com/editorial](http://pumper.com/editorial) for articles and pricing

E-mail [jeffl@colepublishing.com](mailto:jeffl@colepublishing.com) or call 800-257-7222



**IMPERIAL  
INDUSTRIES  
INCORPORATED**



**HAPPY EASTER**



From all of us at Imperial Industries

**THE PROUD TRADITION CONTINUES...**

For Tank Information Contact - Jim Stieber | jim@imperialind.com or Randy Tischendorf | randy@imperialind.com

**Thank You Dvorak Sanitation Service for your order**

**Thank You Pete's Pump for your order**



**Truck Mounted Liquid Waste Tanks**

Designed and manufactured by Imperial Industries  
Available in Aluminum - Steel - Stainless

**Visit our 24 hour on-line parts and accessories store**  
Toilets, Wash Stations and Barricades are now available for on-line purchase!



**Heated Valves**  
don't let your valves freeze!

**Featured On-line**

**"A New Tradition" Toilets, Sinks and Barricades**

- The "Imperial Tradition" Toilet
- The "Imperial Wash sink"
- Construction Barricade
- Also Earth Friendly Chemicals Available



**1100 Gallon STAINLESS**



Ford/Dodge Dealer



**Mark King**

800-722-7382

mking@vhautos.com

**Portable Toilet Service Units**

**Slide-In Units:**

Stock 300 | 450 | 550 Gallon  
Custom Designed Units  
Aluminum - Steel - Stainless

**Truck Mount Units:**

Stock 1100 | 2150 Gallon Alum.  
Stock 875 Steel  
Custom Designed Units  
Aluminum - Steel - Stainless

International Dealer



**Allen Luebke**

800-236-2044

allenl@midstatetruck.com

Imperial Industries Inc. • 505 Industrial Park Ave. • Rothschild, WI 54474 • www.imperialind.com • 800-558-2945 • Fax 715-355-5349



Service technician Brad Jones loads a restroom for delivery in the Big Valley Sanitation yard. (Photos by Marie Burtness)

# Keeping Up APPEARANCES

Sharp-dressed restrooms, clean and responsive service brings repeat business for California's Big Valley Sanitation

By Seiche Sanders

**G**eography is one thing you can't get around in the portable restroom business — literally. Some contrac-

## Profile

### Big Valley Sanitation Redding, Calif.

Owners: **Bill and Sylvia Schmitt**

Founded: **1997**

Employees: **10**

Service area: **Shasta, Lassen, Tehama, Trinity and Modoc counties**

Services: **Portable sanitation, septic and grease trap service**

Web site:

**[www.bigvalleysanitation.com](http://www.bigvalleysanitation.com)**



tors battle icy roads, some steep mountain climbs. For Big Valley Sanitation in Redding, Calif., it's trees. Lots of trees. Nestled deep within a patchwork of national forests, the 13-year-old business owned by Bill and Sylvia Schmitt has embraced the events, opportunities and markets created by its picturesque setting in the northernmost reaches of California.

### EVENTFUL BUSINESS

The Schmitts are lifelong entrepreneurs, having dabbled in a dozen industries since they were married at 16 (they've been married 57 years). It was while the company was operating an RV resort that the opportunity to

buy a septic service vacuum truck came along. Along with that truck came a handful of old, beat-up portable restrooms.

Word of the Schmitts' new business venture spread quickly, and, embarrassed by the shabby restrooms they'd acquired, the couple started buying new ones. So, essentially, two branches of the business launched simultaneously.

From there, great service and creative ideas have fueled Big Valley's growth, allowing it to add restrooms to its inventory every year since 1997. The company has 10 employees and an inventory of about 1,000 units. Approximately 40 percent of the business is pumping septic tanks and grease traps and 60 percent

is portable restroom rentals. Pumping jobs are 60 percent residential, 20 percent commercial septic, and 20 percent is grease trap service.

Special events are the ticket for Big Valley, says Sylvia Schmitt. From rodeos to weddings, the company supplies portable restrooms for about 140 events a year.

"We always make sure we deliver (restrooms) ahead of time, because who wants to worry about them at the last minute?" Usually, restrooms are delivered two or three days ahead of time. "It's out of the way then and one less thing they have to worry about," she adds.

Big Valley has also discovered a unique way for its units to



The Big Valley crew includes (from left) service technicians Ed Ciapponi, Terry Kinney, Charles Whitmore, owner Bill Schmitt, technician Brad Jones and manager Rick Williams.

stand out from competitors, and has seen demand increase as a result. The company can provide units customized for the specific event, with a variety of photo and graphic images adhered to the doors.

#### DECALS TOOK OFF

Finding a decorating method that worked — the decals — was an exercise in trial and error. “Dressing up” portable restrooms this way was not Schmitt’s first idea. Having always wanted to offer a product that was decorative and inviting, she started out trying to paint the portable restroom units, which was generally unsuccessful. Next came wallpaper. Schmitt wallpapered the inside of restrooms, only to have the wallpaper shrivel up and peel, creating a time-consuming cleanup.

Then Schmitt found Wonderland Signs in Redding, which was able to use material for vehicle wraps to adhere graphics to the restroom door.

Customers like the variety of door decals on Satellite Maxim 3000 units from Big Valley Sanitation. While the company so far doesn’t charge a premium for the decorated units, they may figure into bringing repeat business.

Schmitt chooses the photos and Wonderland screens and installs the graphics on the doors. The customization costs about \$125 for each restroom.

So far the graphics have held up. Since Big Valley has only been doing this a couple of years, they have yet to see one of these special units reach the end of its useful life. Schmitt believes the designs will fade before they peel off. But, they also handle these units with care. They keep the

graphics faced inward toward each other when being stored outside. They take special care not to rub or scrape the graphics when strapping units on the trailers.

The idea was a hit. “We started out with just a few to see how it would look and make sure the decals would stay on and the drivers could take care of them,” Schmitt explains. “Now we have 80 to 100 (decaled units) after two years of doing them.”

One unique design features a pathway surrounded by a forest. “When you look at it, it looks like

**“WE MAKE SURE TO GET DRIVERS OUT EARLY IN THE MORNING, BEFORE THE EVENTS OPEN. THERE’S NOTHING WORSE THAN PUMPING PORTABLE RESTROOMS WITH (ATTENDEES) STANDING AROUND. WE FINALLY HAVE CONVINCED MOST OF OUR CUSTOMERS THAT WE WON’T SERVICE RESTROOMS WHEN THE PEOPLE ARE THERE.”**

Sylvia Schmitt

you can look right through to a field,” Schmitt says. There are also balloons, flowers and rodeo scenes, to name a few.

Big Valley works with customers to find out if they’re interested in a unit featuring the special decals, and what, exactly, they’d like. Then they deliver. “We’ll go overboard,” Schmitt says. “But it’s really paid off and helped our business.” Having only offered them for a few years, proof of this is more anecdotal than quantitative. Schmitt uses an example where a new event client was given the option of





At left, a row of service rigs stands ready to service customers at the Big Valley Sanitation yard. Below, service technician Terry Kinney washes a 2005 Kenworth vacuum truck that services septic systems and portable restrooms.

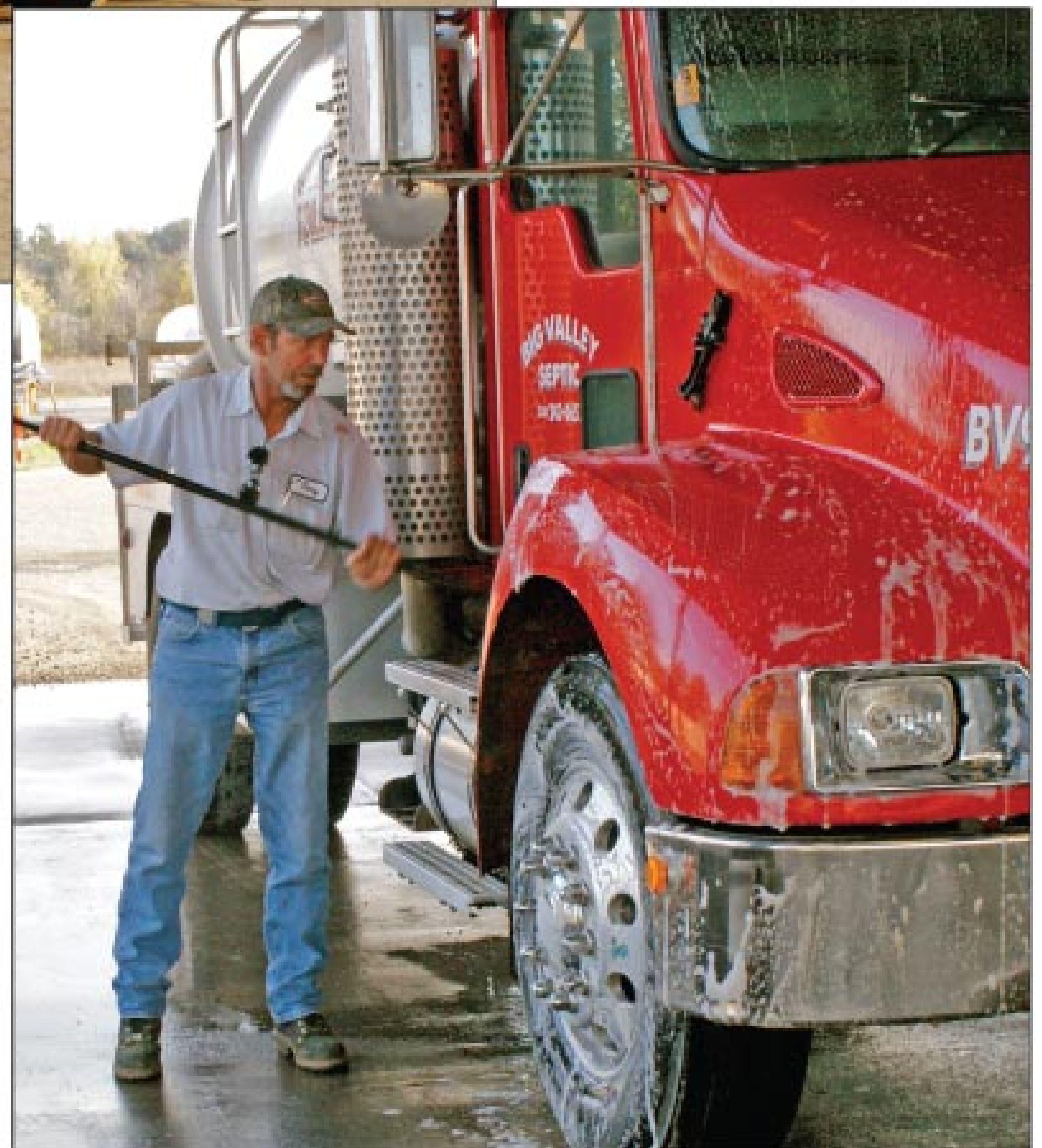

decorated units. “We didn’t charge them extra, but they had more comments from the public, and the public liked them. There’s a group that’s never rented from us before, and I think we’re going to get their (repeat) business now.”

#### CAREFUL SCHEDULING

Women, especially, are hesitant to use portable restrooms, thinking they’ll be dirty and smelly, Schmitt says. “We were trying to make something inviting, something that looks nice on the outside, and they’ll use it,” she adds. “If you had a big event and you had 20 potties there, and two had decals, they would use those and walk by the other ones. It’s crazy, but that’s the way it is,” she adds.

So far, Big Valley doesn’t charge a premium to rent the special units, but they like to think delighting customers pays off in other ways.

Having a significant stock of specifically themed restrooms hasn’t caused supply and inventory pressures for Big Valley, mostly because the company’s inventory consists of more restrooms than it generally needs. Many of the designs, adds Schmitt, are also general enough that they are easily used at various types of events.

For big events, Schmitt says it’s simple to calculate what’s needed based on projected attendance and careful notes

about last year’s attendance and equipment and service order, when possible.

“We just did an air show awhile back that required 60 restrooms. We took them an extra 20 just because we wanted to make sure they had plenty. Then they’re so thankful because they use them all.”

Big Valley emphasizes responsiveness based on careful scheduling.

“We make sure to get drivers out early in the morning, before the events open,” Schmitt explains. “There’s nothing worse than pumping portable restrooms with (attendees) standing around. We finally have convinced most of our customers that we won’t service restrooms when the people are there. So you have to have enough (units) so that you don’t need a truck to come in when people are there.”

#### EQUIPPED FOR SUCCESS

Big Valley’s portable restroom inventory is all from Satellite Industries; half the units are Tufways, half are Maxim 3000s. The Maxim units offer an expansive flat-front panel that well suits the company’s decal placements.

The company’s service fleet includes a 2007 Kenworth T300 with a 3,600-gallon Progress tank; a 2008 Ford F-550 with a 700-gallon waste/350-gallon freshwater unit from WorkMate (FMI Truck Sales & Service); a 2008 Ford F-

550 with a 700-gallon waste/300-gallon freshwater Progress tank; a 2008 Sterling Bullet built by Satellite Industries with a 700-gallon waste/300-gallon freshwater Progress tank; a 2003 Kenworth T300 with a 1,500-gallon waste/250-gallon freshwater tank built by Satellite Industries; a 2004 Kenworth T300 with an 1,850-gallon waste/350-gallon freshwater Progress tank; a 2005 Kenworth T300 with a 2,500-gallon waste/300-gallon freshwater Progress tank. All but one truck utilize Masport pumps; that one has a Conde pump from Westmoor Ltd.

The company also has two 18-unit custom-built portable restroom carrier trailers, an eight-unit trailer, a Caterpillar 430D backhoe to move restrooms

and load trailers, and a Super Mongo Mover made by Deal Associates Inc., to position units efficiently at bigger special event venues.

#### KNOWING THE TERRITORY

Rustling up new business is a welcome challenge for the enterprising team. And while word-of-mouth has been a boon, there are always more customers to reach and more ways to attract them.

“We’re going to a wedding show,” Schmitt explains. “We’ll take reservations then, and then we call them a couple weeks ahead of time so they don’t have to worry about a no-show, and we also work with a lot of wedding planners.”

Big Valley supplies some special event or party venues so



**“WE ALWAYS MAKE SURE WE DELIVER (RESTROOMS) AHEAD OF TIME, BECAUSE WHO WANTS TO WORRY ABOUT THEM AT THE LAST MINUTE? IT’S OUT OF THE WAY THEN AND ONE LESS THING THEY HAVE TO WORRY ABOUT.”**

**Sylvia Schmitt**



Service technician Ed Ciapponi prepares to empty and refresh a portable restroom along his daily route.

often that a few units stay put all the time — Schmitt says there are almost 10 frequent venues where drivers simply have to swing by to set up the units prior to an event.

April to November is the busiest time for events, but when not in full swing supplying rentals, Big Valley is gearing up for the next season.

“We prepare all year long,” Schmitt says. “Every restroom in the yard is ready to go on a job or a special event or a fire, or an emergency situation. It would take an hour or less to load the trailer. We’re prepared all the time to do whatever we have to do.”

Familiarity with all the back roads and the changeable weather is key to efficient dispatching. For instance, if a driver is deliver-

ing portable restrooms to a remote location, he’ll be scheduled so that he can perform pump-outs for customers on that particular route. A driver might also get a call at any point because a customer needs service and that driver happens to be traveling nearby.

Drivers are flexible and willing to act on a moment’s notice. “That’s the way we give good service,” Schmitt explains. “We have really nice looking equipment and our drivers are happy because of this, too,” she adds.

The company’s drivers tend to remain long-term and help bring in repeat business. “They’ll go out of their way to make sure everything is clean so customers recommend us to their friends,” Schmitt adds.

## Helping Fight Fires

If there’s a downside to living in and around the most beautiful heavily wooded areas in the United States, it’s forest fires. And Big Valley Sanitation, Redding, Calif., does its part in a serious effort to tamp down wildfires by providing portable sanitation to firefighters on the front lines.

The company has contracts with 15 or 16 local, state and federal fire service agencies and can get calls at any time to provide restrooms, according to owner Sylvia Schmitt. With restroom inventories kept in four yards throughout the region, Big Valley can deliver units and wash stations to the most remote region within a few hours. Often, they deliver to the camps where the firefighters stay.

Big Valley has had portable restrooms tumble down cliffs and fall into lakes, but despite the perilous conditions of fire season, the company has yet to lose a unit to fire. Employees, however, know when and where to wear hard hats and flame-retardant jackets, even though they are generally delivering to sites out of harm’s way. At times, the fire services have called to warn the company that a camp is in the line of fire, and to get their units out fast.

Accurately predicting fires and what they’ll do is impossible, of course, and some years there’s lots of action; other years, almost none. When necessary, Big Valley adds extra help to maintain service to existing routes while servicing fire contracts. Finding temporary employees to help out has actually been easy. With the fires come willing jobseekers. Schmitt says the calls roll in.

What impact does a busy fire season have on inventory? Big Valley has enough fire, emergency and special event business to know inventory demands can fluctuate greatly, and they’ve built a working stock that all but once has exceeded demand.

“We make sure we have plenty here and plenty for our normal customers,” Schmitt explains. “You never know how big of a fire it’s going to be and how many (units) they’re going to want. When fire season starts, we just don’t leave the phone.”

### GOOD HONEST SERVICE

Having lived and worked in Redding most of their lives, the Schmitts have a solid knowledge of the people, the geography and business dynamics. They’ve run a large home design store for 20 years, and a concrete plant in the area — businesses that offered cross pollination opportunities with customers building and designing homes.

Word-of-mouth helps, too — the company has never advertised beyond the Yellow Pages.

“We’ve lived here for 50 years, so there’s lots of word-of-mouth. We know the types of businesses (we service). (Customers) know they’re going to get good and

honest service and we’ll take care of any problems they might have.” ■

### MORE INFO:

**Deal Associates Inc.**  
866/599-3325  
[www.dealassoc.com](http://www.dealassoc.com)

**FMI Truck Sales & Service**  
800/927-8750  
[www.fmitrucks.com](http://www.fmitrucks.com)

**Masport Inc.**  
800/228-4510  
[www.masportpump.com](http://www.masportpump.com)

**Progress Tank**  
888/543-2121  
[www.progresstank.com](http://www.progresstank.com)

**Satellite Industries Inc.**  
800/328-3332  
[www.satelliteindustries.com](http://www.satelliteindustries.com)

**Westmoor Ltd.**  
800/367-0972  
[www.westmoorltd.com](http://www.westmoorltd.com)

# Experience Matters

Designing, Developing and Delivering for over 35 Years

Tank fabrication in mild steel, hot dip galvanized, and stainless steel. Bare tanks to complete trucks.

## 12 Volt DC Drive Pump Package

Our customers have found many uses for this mini portable pump package. Quiet running, light weight, compact size makes a perfect fit for servicing portable restrooms and grease traps.

- Fan cooled 4 vane pump
- 30 CFM / 1500 RPM
- Auto drip oilers
- 1 Pint oil reservoir
- 12 volt D.C. motor
- Oil catch/muffler
- 2" Secondary shutoff
- Automatic vacuum shutoff
- 3 to 1 adjustable belt drive
- 165 lbs. / 28"x17" footprint

**\$2550**

80 CFM Gas Version  
8HP Honda electric start with Hertell B-1600 4 vane pump  
**\$2850**

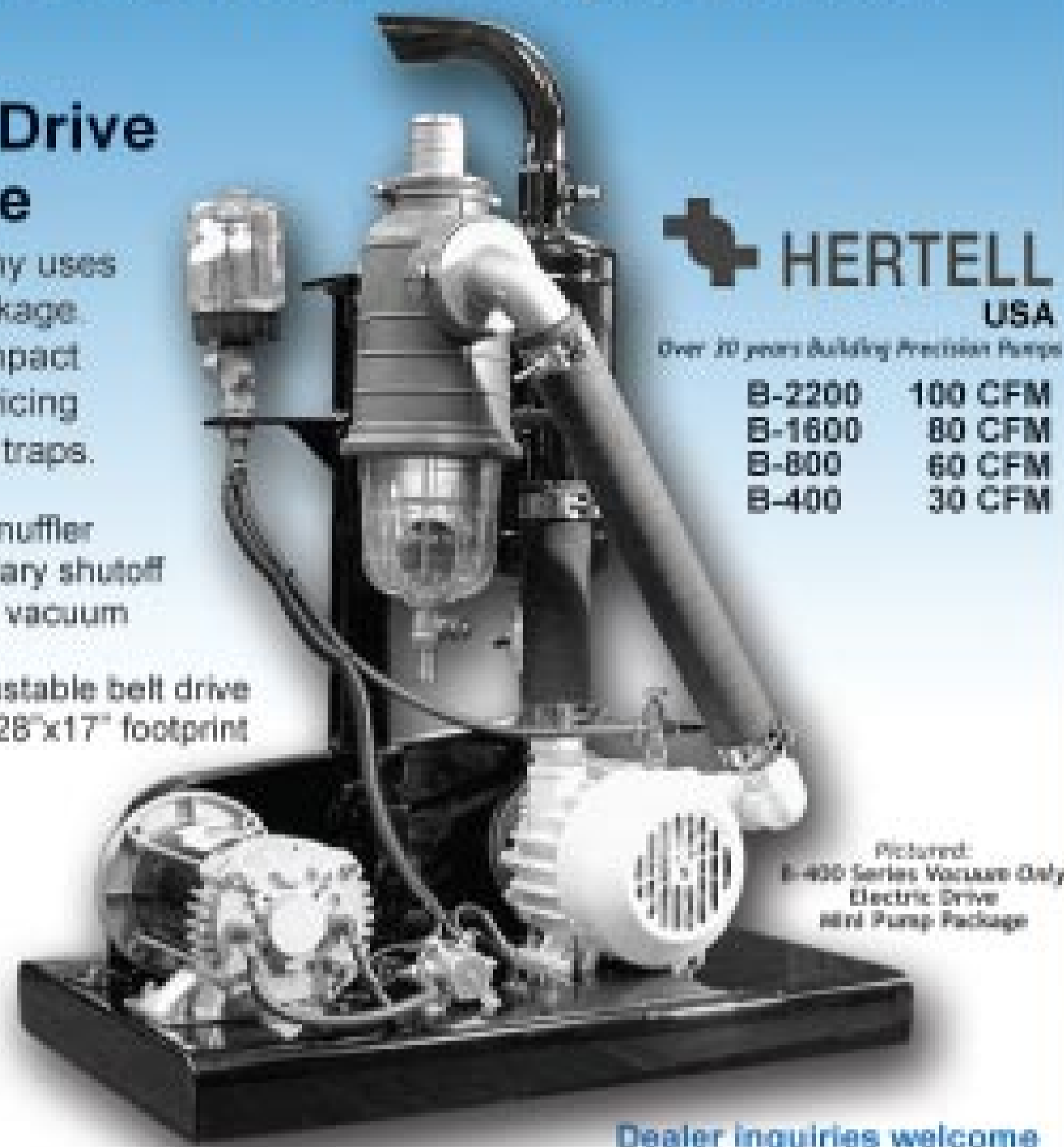

**HERTELL**  
USA

Over 30 years Building Precision Pumps

B-2200	100 CFM
B-1600	80 CFM
B-800	60 CFM
B-400	30 CFM

Pictured: B-400 Series Vacuum Duty Electric Drive Mini Pump Package

Dealer inquiries welcome

## Slide-In Units 400 Gallon Custom Split Configurations

Choice of pump drive locations (rear or side mount) - 8 HP Honda electric start and 94 CFM Jurop pump - Electric wash down pump - Sight eyes for waste and fresh water compartments.

**\$7900**

Pictured: Rear mounted 8HP Honda electric start with 94 CFM Jurop PN23 - 400 gallon 300/100 split - Waste side sight eyes - 50 PSI wash down pump 60 ft hose and spray wand - 2" secondary shutoff - Oil catch/muffler



**New and Used Pumps  
Sales & Service  
TRADE-INS  
WELCOME**

MASPORT - PB PUMPS  
WITTIG - NVE - FRUITLAND  
JUROP - MORO - BATTIONI



# LMT

**CUSTOM TANK FABRICATION**

1105 SE 2nd Street P.O. Box 142 Galva, IL 61434

Ph. 800-545-0174 Fax 309-932-3155  
www.tanksandpumps.com www.pbumps.com

## LOCATE WITH THE BEST

WHETHER YOU ARE JUST GETTING STARTED OR YOU ARE AN OLD PRO, you can rely on Prototek for the best flushable transmitter and receiver systems in the industry. **FLUSH AND FIND** Locate underground nonmetallic tanks and lines with our orange AT-12 flushable transmitter and AR-1 receiver. Locate in cast iron or nonmetallic lines with our blue FT-8 flushable transmitter and FR-1 receiver. Recycle your used flushable transmitters back to us for credit toward your next purchase.



**Prototek**



ECONOMICAL • EASY **800-541-9123**

www.prototek.net email: prototeksales@prototek.net

## KLEEN PRO TECH

Specialists in Portable Toilet Deodorants



We provide you **superior** odor control!

Clean protection for **your** clients

**262.527.9804**

www.kleenprotech.com

Quality Guaranteed • Excellent Customer Service

## Less Noise

Vac-Con's larger capacity hydrostatic pumps allow the system to perform at a much lower RPM which means quieter operation, a healthy benefit for operators and community residents around the world.



## Less Exhaust

Because of the efficiency of our hydrostatic drive systems, Vac-Con machines use less fuel, which means lower cost...and less exhaust.

## Less Fuel

Vac-Con's exclusive 3-Stage Centrifugal Compressor operates at a performance level that loads material faster than the competition. This equals Less Time on the job which means Less Fuel is used.

## Less Water

Vac-Con's available high pressure/low volume water systems conserve water.

**We Were "Green" Before It Was Even Called "Green"**

VAC-CON MACHINES HAVE BEEN "GREEN" FOR MORE THAN 20 YEARS.

Vac-Con is proud to be a leader in the worldwide environmental industry.

We have been manufacturing products that assist public and private entities in maintaining water collection systems and treatment facilities for more than two decades. We can all help assure that the world's potable water supplies are preserved for future generations simply by not wasting or polluting this precious resource. *Think high pressure/low volume!*

VAC-CON MACHINES – LEADING THE INDUSTRY IN "GREEN" INITIATIVES.



A HOLDEN INDUSTRIES Company

[www.vac-con.com](http://www.vac-con.com)

# GREAT STUFF!

## AT THE PUMPER & CLEANER ENVIRONMENTAL EXPO, ATTENDEES ZEROED IN ON THE BEST NEW PRODUCTS THE LIQUID WASTE INDUSTRY HAS TO OFFER

By Jim Kneiszel and Ed Wodalski

**L**iquid waste haulers saw the latest industry innovations spread across the expansive exhibit floor at the Kentucky Exposition Center during the 30th annual Pumper & Cleaner Environmental Expo International Feb. 24-27 in Louisville, Ky. From small accessories like solar restroom lighting to self-contained septage disposal systems, pumpers got the goods on the newest products

aimed at running their companies efficiently and building profits for the 2010 busy season.

In all, 493 industry exhibitors showed their wares to 8,784 attendees from 3,921 companies. Here's a sampling of products displayed at the Expo for the first time:

### RESTAURANT GREASE CONTAINER

**Enviro tub** introduced an indoor grease collection container aimed at commercial kitchens with little storage space. The 55-gallon tub measures 18 inches wide by 28 inches long by 32 inches high, and is designed to fit under most two- and three-compartment sinks. It is made of recycled plastic and has a self-closing lid to limit odors and spillage. Contractors can purchase the unit for their restaurant grease trap customers, and wheel it in and out of the kitchen to pump grease when they don't have adequate access to empty permanent indoor traps. **866/777-4322; www.enviro tub.com.**



### SMALL SCALE DEWATERING PRESS

**BDP Industries** showed the **Model DDP belt press** aimed at small-scale septic service companies that want to create their own disposal solution. Built to be either skid- or trailer-mounted, the unit features a 0.9 meter belt press and uses a polymer flocculating agent to process up to 80-100 gpm of septage and produce 20 percent cake solids. For contractors handling



a million gallons per year or more, the unit is designed to eliminate 99 percent of total suspended solids and reduce BOD and COD levels so that effluent can be routed into a city sewer. Cake is land-applied or taken to a landfill. The frame is made of stainless steel. Other components are plastic or rubber to limit corrosion. **518/695-6851; www.bdpindustries.com.**

### GREASE SPECIALTY VACUUM TRUCK

For companies building a grease trap service specialty, **Vacutrux** offered the **Biomass City Grease Trap Pumper**. Built on a Kenworth chassis, the truck features a low profile and lengthened wheelbase. It carries a 2,300-gallon tank and 350-cfm liquid-cooled Wallenstein pump specifically aimed at pulling grease efficiently. The truck also features an enclosed hose reel with 200 feet of 2-inch hose for a long reach and another box that holds a vacuum drum and power head when the hose won't reach an interior trap. **519/669-1625; www.vacutrux.com.**



### MOVABLE HITCH ADAPTER

**Williams Innovations** introduced the **TeleSwivel hitch adapter**. The swivel enables an individual to connect a truck and trailer in a single pass. The adapter features a target zone 25 times larger than a standard ball hitch. The coupler inserts into any 2-inch receiver. To use, the operator backs into position, swivels the hitch, connects and backs up to lock in place. The adapter is Class IV rated for up to 10,000 pounds gross trailer weight, 1,000-pound tongue weight and accepts any size ball. The BX model accepts a three-ball or pintel hitch, while the Pro adapter is rated at 14,000 pounds and comes with a 2 5/16 and 2-inch ball as well as pintel capability. It also features seven inches of drop for easier hookup. **919/794-5484; www.teleswivel.com.**



### REMINDER CARD SOFTWARE

**Ritam Technologies Inc.** released **Summit Reminders Plus**, a simple program for users who don't need to track invoicing. The software enables users to catalog customers, jobsite locations and job types, as well as enter notes for history, date of last service and frequency — by day, week or month. The program calculates when a reminder postcard should be mailed to customers. The software is designed for septic and grease trap service, or anyone who maintains a customer base. **800/662-8471; www.ritam.com.**



## THICKENING REACTOR

**NewTech Inc.** **Dewatering Systems** introduced its **Thickening Reactor**. The unit is made to thicken liquid waste, cutting disposal and transportation cost. The self-contained, sealed stainless steel tank features level sensors and is self-cleaning. The bottom-fill system can process 15,000 to 20,000 gallons per batch, three batches per day. Used in series, waste can be continually thickened without having to shut down the process. The system also can be used to thicken grease trap waste for digester use. A tank camera is available. **800/210-2361; www.dewater91.com.**



## GRINDER PUMP

**Webtrol** displayed its 2-hp **W202GDS grinder pump**. The unit features a hardened stainless steel shredding ring and grinding cutter. The recessed (vortex) impeller design reduces bearing load and prevents clogging. Internal capacitors eliminate the need for external controls. A silicon carbide mechanical seal with secondary lip seal helps prevent leakage, while the oil-filled motor dissipates heat buildup. The pump has a 30-foot cord, 1.25-inch discharge and operates on 230 volts. Featuring a cast iron body with ductile iron base, the pump delivers 5 to 40 gpm with a total dynamic head of 45 to 103 feet. **800/769-7867; www.webtrol.com.**



## WASTEWATER TREATMENT SYSTEM

**Presby Environmental** introduced the **Advanced Enviro-Septic** wastewater treatment system designed to remove up to 99 percent of contaminants. The system treats and disperses wastewater in the same footprint, requires no energy, computer controls, media replacement or special maintenance. Available in both NSF-40 Class I certified and non-certified installations, AES can be flexible in design and adaptable to challenging sites. The non-mechanical treatment process begins when warm effluent enters the system and is cooled to ground temperature. As suspended solids separate from the effluent, skimmer tabs further capture grease and suspended solids. Pipe ridges enable effluent to flow uninterrupted and aid in cooling. Bio-Accelerator fabric screens additional solids, developing a biomat that provides treatment and ensures accelerated biomat development. A mat of coarse fibers separates more solids as effluent passes into the geo-textile fabric and grows a protected bacterial surface. Sand wicks liquid from the fabric, enabling air to reach the bacterial surface to break down solids. **800/473-5298; www.presbyenvironmental.com.**



## TANK INSPECTION CAMERA

Designed for inspecting septic tanks, vaults and enclosures not physically accessible or too hazardous to enter, the **Tank Inspection Camera** from **Remote Vision System** features a portable, pole-mounted video camera system. The viewing systems are fully portable and include camera (8 inches x 3 inches x 2 inches), 4- or 5-inch television monitor, 18-foot telescoping pole, 50 to 75 feet of cable, 12-volt battery, power cords and carrying case. The inspection system can operate in an opening as small as 3.5 inches and is designed for overhead as well as underground viewing. Elite Remote Vision System models include a digital video recorder. Data can be downloaded and viewed on a computer or television screen. The Premier model can be coupled with a DVR to record all video viewed by the system. **612/221-6690; www.remotevisionsystem.com.**



## VACUUM PUMP PACKAGE

Made to bolt to a truck frame, the **500 Eliminator** vacuum pump package system from **Fruitland Tool & Mfg.** is available with a RCF 500 (350 cfm free-air) or RCF 370 pump. The package includes gearbox, secondary and oil catch muffler. It also includes filter and four-way valve, pump mounting bracket, angle or hydraulic drive mounting bracket, moisture trap, pressure and vacuum relief valves, pressure and vacuum gauge and drain valves. **800/663-9003; www.fruitland-mfg.com.**

## GREASE TRAP VACUUM

**Westmoor Ltd.** displayed its redesigned 52-gallon **Conde ProVac** industrial liquid waste pumping system. Available in steel or aluminum, the unit features a 35-cfm ProVac pump. The pump and motor automatically turn off when the tank is full. Powered by a 13.4-amp motor, the system plugs into any 15-amp service. The 24-inch wide and 45-inch high unit fits through any standard door or cargo van opening. Features include hand parking brake, exhaust deodorizer, 25-foot retractable cord reel, hose rack and tool holder. Other features include 120-gpm pump capacity, 2-inch by 10-foot plastiflex suction hose and wand, 6-inch cleanouts top and bottom, pressurized offloading, sight glasses, heavy-duty wheels and front casters. **800/367-0972; www.westmoorltd.com.**



## REMOTE TANK MONITOR

The **GreaseWatch3 tank monitor** from **Remote Tank Monitors LLC** is a wireless, cellular, battery-operated system that senses the sludge level on the bottom of a grease trap or septic tank, temperature, how much floating grease and oil is inside and liquid level. An above-ground, street-level antenna can be embedded in concrete or asphalt for a totally contained unit. Designed primarily for food service providers, the Internet-based system transmits daily data that can be analyzed by the facility manager, assisting in pump scheduling, tank functionality and emergency service notification. **989/928-1806; www.remotetankmonitors.com.**



## JOBSITE TRAILER

Made for use at remote special events and jobsite locations, the aerodynamic **Galileo Site Manager's Suite RS21** towable RV from **JMS (JAG Mobile Solutions)** sleeps four, seats eight at two sofas and five at the



expandable dining table with flip-down jump seat. The 21-foot model has an exterior width of 91 inches with an additional four inches for the entry door assist handle and an exterior height of 114 inches. The interior is 80 inches high in the main living area, bathroom

and walk-in shower. The unit weighs between 4,500 and 4,980 pounds, depending on options. Features include 27-gallon waste and 35-gallon freshwater tank, six-gallon LP water heater, 13,500-Btu propane furnace with thermostat, 30-amp RV connection, 7.5-cubic-foot refrigerator with freezer, counter range, convection/microwave oven, day/night designer blinds, custom cabinetry and cork flooring. **888/709-1999; www.discoverthememories.com.**

## HYDRAULIC TRAILER

The **LiftHaul hydraulic trailer** from **F.M. Manufacturing Inc.** takes the challenge out of loading and unloading restrooms, supplies and equipment. A touch of the switch lowers the rear of the trailer to serve as a drive-on ramp. If needed, the front also can be lowered for ground-level loading. The aluminum trailer has a towing capacity of 2,500 pounds. The steel model can haul 3,500 pounds. Currently available in single axle, a larger tandem axle model will soon be available. **877/889-2246; www.fmmfg.com.**



## NATURAL RESTROOM DEODORIZER

**EverGreen** portable restroom deodorizer from **J & J Chemical Co.** is non-toxic and 100 percent biodegradable. It uses no biocides, bacteria or enzymes while eliminating waste and foul odor when disposing at a dumpsite. Available in concentrate and super concentrate formulas, the deodorizer is offered in quantities of one to 275 gallons, comes in 18 scents and can control odor for up to 14 days. **800/345-3303; www.jjchem.com.**



## SOLAR RESTROOM LIGHT

A tiny solar panel in the top of the light recharges the battery that powers the **Firefly restroom light** from **Aglow Systems**. The motion-activated light lasts up to seven days on one charge. Multiple LED bulbs provide up to 80,000 hours of life. Waterproof for outdoor exposure, the light mounts to the ceiling of the restroom with 3M 4004 Permabond for maintenance-free operation. **865/686-8811; www.aglowsystems.com.**

## RESTROOM AND SHOWER TRAILER

**Comforts of Home Services Inc.** displayed its 53-foot **combination shower and restroom trailer**. Built for cruise ship passengers in the Virgin Islands, the unit features an ADA restroom with hydraulic lift that lowers for easy access, men's restroom with toilet and seven urinals and 12 single restrooms, including two with showers. The trailer has 1,400-gallon waste and 1,400-gallon freshwater tanks, 20 kW generator, heating and air conditioning units, two LCD TVs, hardwood flooring, hands-free faucets and low-volume, water-saving toilets. **877/382-2935; www.cohsi.com.**



## WET-WIPE DISPENSER

**Handago** introduced a self-contained **wet-wipe dispenser**. The free-standing station features two wipes dispensers, enclosed trash receptacle and storage. Made of weather-resistant polyethylene, the unit has a key lock to secure the door and lid. Two wheels at the front provide easy transport. The station has a 21-inch square base and stands 41 inches tall. It offers advertising panels at the back of the unit. The alcohol-free wet-wipe formula is safe for children's hands and faces. Made with aloe, Vitamin E and organic compounds, the formula is designed to replenish skin while killing 99.9 percent of germs. **888/408-4188; www.handagoinfo.com.**



## HEAVY DUTY VACUUM HOSE

New from **Kuriyama of America Inc.** is the **Tigerflex Tiger-TR1** heavy duty, rubber blend, wet and dry vacuum hose. Made with rigid PVC helix for light weight, flexibility and durability, the hose features smooth bore construction that eliminates material buildup, while the convoluted cover design keeps the hose flexible for easier handling and durability. Made to withstand temperatures from -40 degrees to 150 degrees F and working pressures from 13 to 32 psi, the hose is available in 2- to 6-inch I.D. and 2.38- to 6.88-inch O.D. It has a vacuum rating of 24 through 28 Hg, a minimum bending radius of 1.5 to 9.5 inches at 68 degrees F and is available in 20-, 50- and 100-foot lengths. **847/755-0360; www.kuriyama.com.**



## HOLDING TANK

The low profile high-density polyethylene **Mega Holding tank** from **Kentucky Tank** holds 1,275 gallons and measures 36 inches tall, 81 inches wide and 130 inches long. A 1,600-gallon model measures 84 inches wide, 126 inches long, 42 inches tall and comes in black or natural colors. It can be used as a waste-hauling tank for construction or office trailers or as a holding tank back at the shop, as well as a hauling tank on a flatbed. The tanks can be fitted with an optional locking lid, fittings and level alarm. **888/459-8265; www.kentuckytank.com.**



## HIGH RISE CONSTRUCTION UNIT

The **convertible-top HIGHRISE** unit from **Satellite Industries Inc.** is a versatile wheeled restroom aimed at commercial renovation or construction projects. The unit was designed to fit through standard doorways and for easy loading onto freight elevators in high-rise buildings. It can be purchased with or without the angled roof section. The roof section can be removed or folded down. The lift kit tilts down to fit through low doorways or in elevators. The sturdy single-wall unit is built with galvanized frame and floor to resist corrosion in challenging jobsite



environments. It rolls on 6-inch locking wheels with sealed bearings to prevent wear from dust infiltration. The unit also has integrated grab handles to easily move it around the jobsite. The unit comes in Patriot blue. **800/328-3332; www.satelliteindustries.com.**

## SEPTIC TREATMENT

Intended to promote consumer education and ensure peace of mind, the **Pro-Pump Septic Saver** combo kit from **Ecological Laboratories** is designed to provide a high rate of biological activity and oxidation of waste material, as well as promote the rapid breakdown and removal of waste material in drainfields. The kit includes Pro-Pump/HC and Pro-Pump/SP packaged as a 12-month treatment program. The Septic Saver kit also includes water test tablets to check for toilet and faucet leaks, Septic 101 and Pro-Pump Q&A brochures as well as consumer tips on maintenance and service. Pro-Pump/HC is made for use after pumping to recharge the septic system. The non-toxic, non-pathogenic formula is safe for plants, animals and people. Pro-Pump/SP contains enzymes to break down organic and inorganic solids and is designed as a monthly septic treatment. **800/326-7867; www.propump.com.**



## SANITIZER STAND

To answer growing concern over spreading illnesses, **T.S.F. Company Inc.** introduced the **Handy Hand Sanitizer** stand in a variety of eye-catching colors. The sanitizer stand is a three-piece rotomolded unit that comes assembled with a top, base and stem. The sealed base with port allows for adding five gallons of water to improve stability and prevent tipovers in heavy winds. The unit carries any combination of two to four sanitizer units of the customer's choosing. Two sanitizer stands fit inside a standard restroom for convenient transportation. Color offerings include orange and pink for better visibility in a grouping of

restrooms at special events. **800/843-9286; www.tuff-jon.com.**

## ADA-COMPLIANT RESTROOM UNIT

Italian restroom maker **Armal** introduced a prototype of a new handicap unit, the **HN**, which complies with the dimension requirements of the Americans with Disabilities Act. The unit has two horizontal and two vertical metal grab handles integrated into the restroom walls. The large floor space allows for 360-degree wheelchair rotation and room for an attendant. The unit has an optional 26-gallon wash station that is easily added and removed. Additional features include a three-roll paper holder with built-in shelf, a lowered 53-gallon tank for disabled users and optional bicycle-style wheels that can be easily added to move the unit. The HN weighs 253 pounds and is 63 inches wide, 83 inches deep and 90 inches high. **770/491-6410; www.armal.biz.**



## SANITIZER STATION

**PolyPortables Inc.** unveiled the **Sanitizer Station**, a stand-alone ADA-compliant sanitizer dispenser to accompany portable restrooms at construction sites and special events. The heavy-duty stand is made of gray extruded plastic panels that are bolted together, creating supply storage in the center post. A flip-top cover protects dispensers from the elements and allows access to the storage area. The unit weighs 44 pounds, has an 18- by 18-inch base and measures 53 inches tall. The unit comes with either gel or alcohol-based atomizing dispensers and refills, or can be purchased without dispensers. One of the four dispenser stations is at wheelchair height. The base of the unit can be tied down for added stability at the jobsite. **800/241-7951; www.polyportables.com.**



## MACERATOR PUMP FOR ADA RESTROOM TRAILER

**Ameri-Can Engineering** updates its line of ADA-compliant restroom trailers with the **Sani-Lav macerator pump**. The sealed electric pump assembly with stainless steel blades conveys wastewater from a ground-hugging ADA section of restroom trailers into a central holding tank, eliminating the need for a

small waste tank dedicated to the ADA unit. Black- and greywater are collected from the lowered unit and the 3/4-hp pump can move the effluent as far as 300 feet out and 30 feet up. The Sani-Lav pump can also be used to create ADA-compliant shower trailer units. **574/892-5151; www.ameri-can.com.**

## COMPACT SANITIZER DISPENSER

**PolyJohn Enterprises Corp.** introduced a smaller companion to its SaniStand sanitizer station, the **Hand Sanitizer**. The unit uses back-to-back touch-free foaming dispensers or can be outfitted for use with sanitary wipe dispensers. Greater portability was a goal of the new sanitizer stand — several stands can be shipped inside one standard restroom unit. The top and bottom sections separate, and water or sand can be added to the base for greater stability. The unit also has a display area for advertising. **800/292-1305; www.polyjohn.com.**



## ADA RESTROOM TRAILER

**Rich Restrooms** introduced the **Model 715 restroom trailer**, which meets ADA wheelchair-accessibility requirements. After transport to a job, the trailer is lowered to the ground, providing easy accessibility with a wheelchair ramp for one large restroom station, and two non-ADA restrooms. The trailer has a 345-gallon holding tank and a mechanical room for ramp storage. The trailer is part of the company's Everest line. The ADA station's stool, sink and floor plan are designed for the greatest accessibility. **260/593-2279; www.richrestrooms.com.**



## LANDSCAPE LIDS

**Orenco** introduced its watertight and durable fiberglass **Landscape Lids**. The decorative lids can support a 2,500-pound wheel load. Designed to provide a secure covering for septic system risers, the lids come with stainless steel hex-drive screws and hex key. Tamper-proof bolts are available for greater security. The lids come in grass, river rock and bark mulch patterns in 18-, 24- and 30-inch diameters to fit AX20 and AX100 pods. **800/348-9843; www.orengo.com.**



## DRAINFIELD RESTORATIVE

**RCS II Inc.** displayed its **Septic Drainer drainfield soil restorative**. The formula is designed to break the bond that can form between soil and sodium, improving perkability and drainage, minimizing the need for septic pumping, eliminating septic backup and restoring septic systems without digging. **518/812-0000; www.septicdrainer.com. ■**



Make Plans Now to Attend the  
**2011 PUMPER & CLEANER  
ENVIRONMENTAL EXPO INTERNATIONAL**  
March 2-5, 2011 • Louisville, KY



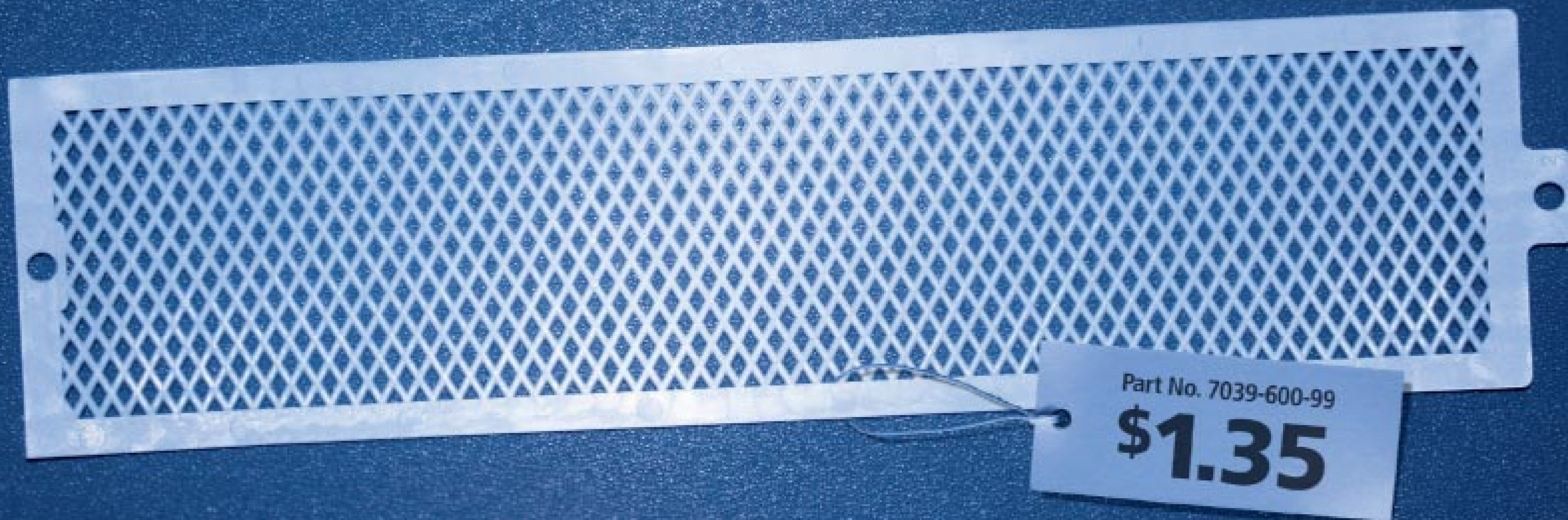

**Bang! Bang! This simple 2-rivet replacement screen helps you make repairs quick.**

# Plus there's a bonus...

**SO WHAT'S THE BONUS?** This same low-cost replacement screen fits all PolyPortables' restrooms. So there's no need to stock a variety of screens to fit different models.

**IN FACT, ALL POLYPORTABLE RESTROOMS SHARE MOST OF THE SAME REPLACEMENT PARTS.** And we have no minimum parts order. That makes life easier and helps you keep your units where they should be – out in the field earning money.

**IT TAKES MORE THAN A FANCY LOOK TO MAKE A GOOD RESTROOM.**

We think they should be practical, tough and easy to maintain. Repairs should be a breeze. Parts should be easy to get and interchangeable whenever possible. Don't you agree? PolyPortables – you can build a business with us.

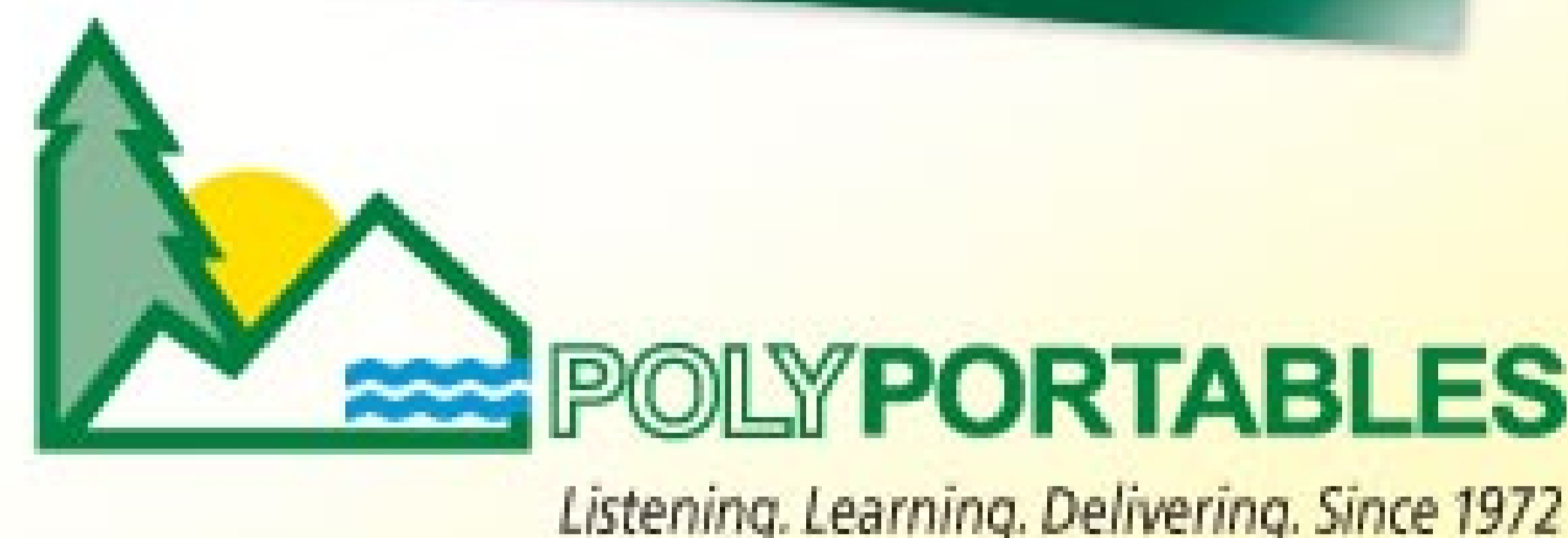

99 Crafton Drive, Dahlonega, GA 30533 USA • Phone (800) 241-7951 or (706) 864-3776 • Fax (706) 864-8111 • [www.polyportables.com](http://www.polyportables.com)

PORTABLE TOILETS • HANDWASH STATIONS • PUMPER AND FLATBED TRUCKS •  
DEODORIZERS and CLEANERS by GREEN WAY PRODUCTS



# Flexible and Affordable Financing Options

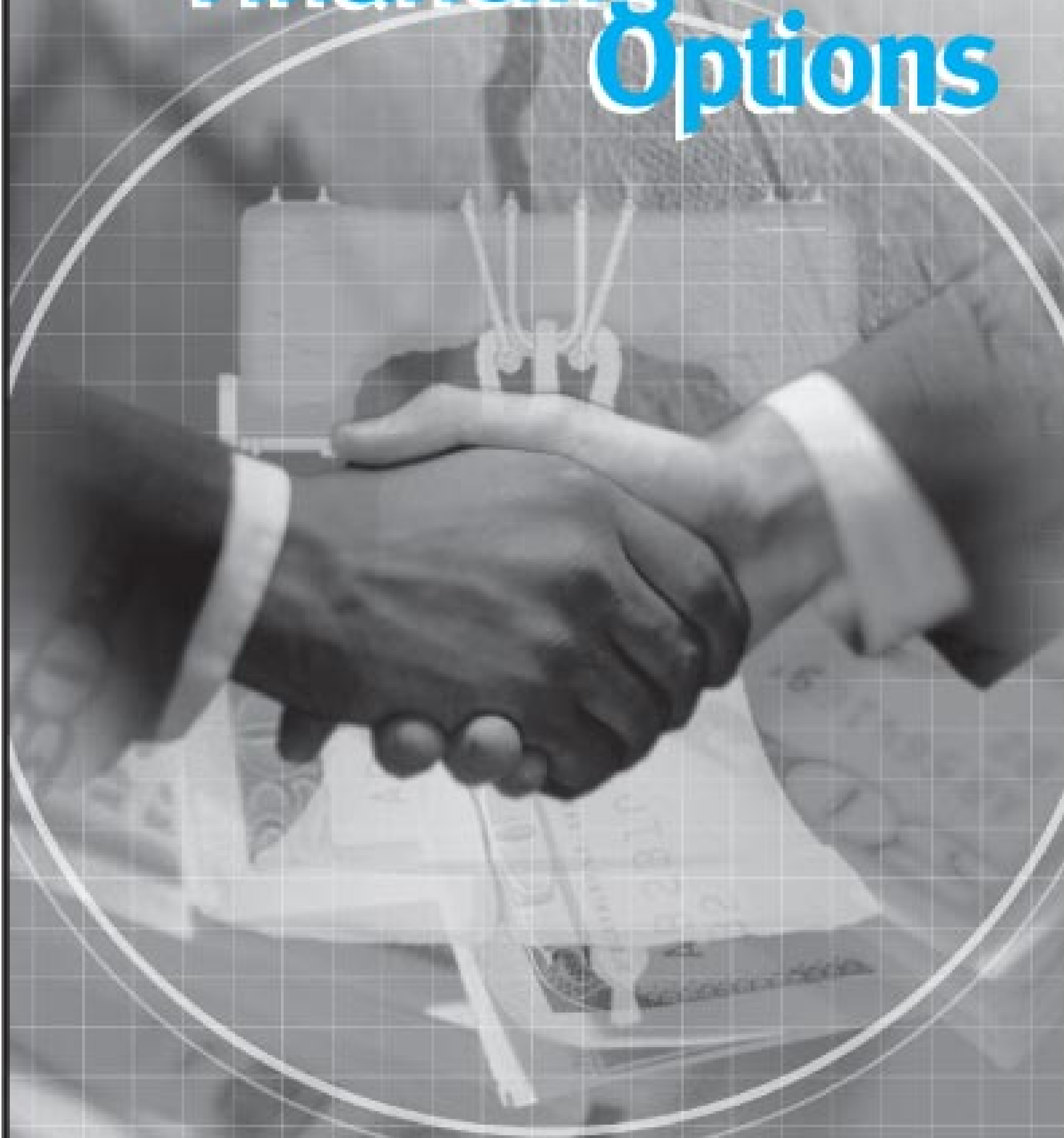

## Financing for New and Used Equipment:

Trucks                      Tanks  
Trailers                     Toilets  
Cameras                    Jetters

also Computer Hardware & Software



**Thank You  
for visiting us**



7 Church Road Hatfield, PA 19440  
Phone: 800.422.1844 Fax: 888.883.9380  
Visit our website: [www.libertyfg.com](http://www.libertyfg.com)

**COMMERCIAL EQUIPMENT FINANCING  
CALL 800-422-1844**

# NU CONCEPTS

MANUFACTURER OF QUALITY PORTABLE RESTROOMS AND SINKS



## Dual VIP Restroom Trailer From \$9,841

**Ideal for:**

- Weddings / Parties
- Sporting Events
- Food Festivals
- Community Events
- Restroom Remodeling
- Movie Production

**Features:**

- Solar Powered
- Self-contained
- Flushing, china toilet
- Enclosed sink
- Power Converter (option)
- Air-conditioning (option)
- Interior Heater (option)
- Sink Water Heater (option)



1737 S. VINEYARD AVENUE • ONTARIO, CA 91761  
PHONE 909-930-6244 • TOLL FREE 800-334-1065 • FAX 909-930-6237  
[www.NUCONCEPTS.com](http://www.NUCONCEPTS.com)

**435 GALLON VACUUM TANK**



- 1/4" Aluminum Construction
- Conde Super 6 Pressure Vac Pump with 5.5 hp Honda Electric Start
- 12 Volt Water Pump
- 300 Waste/135 Fresh
- 25' Hose and Wand
- 2" Sight Eyes in Waste
- Sight Tube on Fresh Water
- Completely Self-Contained
- Ready to Work

**\*OTHER SIZES AVAILABLE\***

**Robinson Septic Service Inc.**

125 Rockrimmon Dr., Bellefonte, PA 16823 • 1-814-353-0263 • email: [honeydippers@aol.com](mailto:honeydippers@aol.com)  
1.800.252.3848 • [www.robinsonseptic.com](http://www.robinsonseptic.com)

# Milwaukee Rubber Products

## KANAFLEX HOSE

### Rubber Hose 300 EPDM

All Weather Water  
Suction Hose

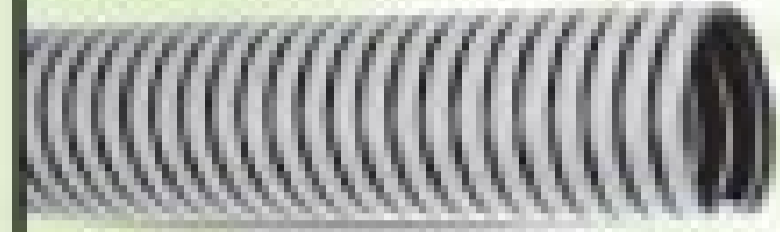

1-1/2", 2", 2-1/2", 3", 4",  
6" Cut to Length

### 220 RS

Low Temp Rubber  
Water Hose

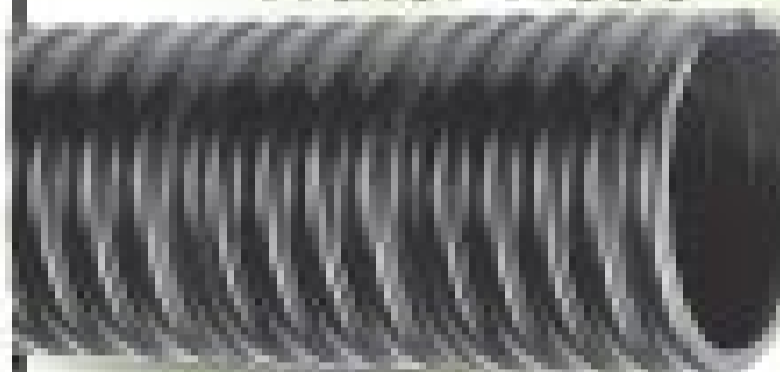

1-1/2", 2", 3", 4", 6"  
Cut to Length

### 180 AR

Abrasion Resistant  
Suction Hose



1-1/4", 1-1/2", 2", 2-1/2",  
3", 3-1/2", 4", 6", 8"  
Cut to Length

### 180 HR

High Temp Suction Hose

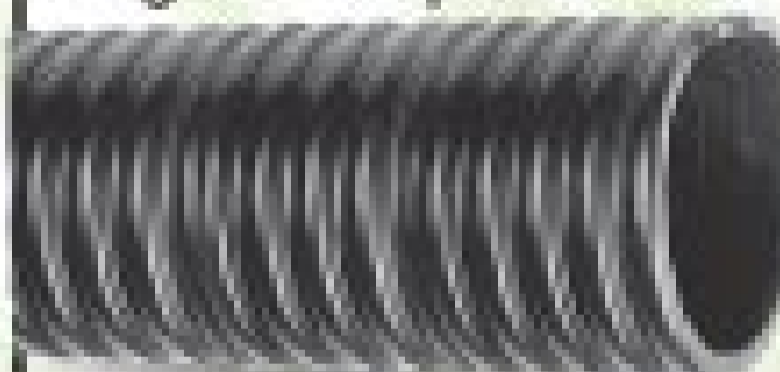

4", 6", 8" Cut to Length

### KANALINE SR

Suction & Discharge Hose



1-1/2", 2", 3", 4", 6", 8",  
10" Cut to Length

### Piranha Hose



Sewer Jetting Hose

### Plastiflex Black/ Yellow Hi-Vac Suction Hose (Tigertail)



1-1/2", 2", 3" Lengths: 20, 25,  
30, 35, 40, 50, and 60 FT.  
W/Cuffs.

### Sewer Hose Guides



2" ID X 3'  
3" ID X 3' W/Cuffs,  
Clamp, Rope & Ring

### Green Monster Vac Hose

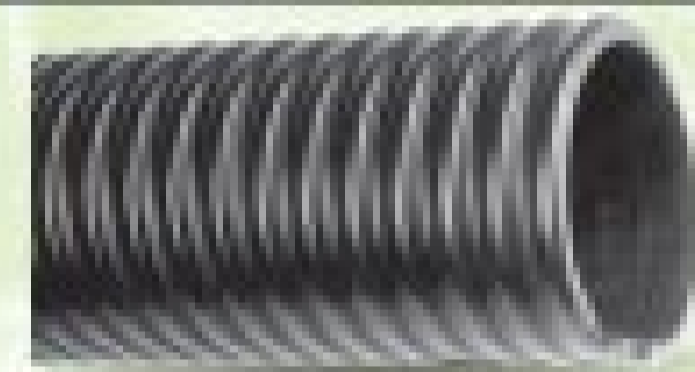

2", 3", 4", 5", 6", 8" 50 ft Boom  
Hose, Cut Lengths available

### Hose For All Applications

Chemical Hose, Water, Air,  
Septic, Oil Hose, Compressor  
Hose, Grout Hose, Sandblast,  
Hot Air, Hot Tar, Asphalt Hose,  
Push-On, Vac Hose.  
Call For Your Application.

## PUMPS

### Jurop



### Moro



## VALVES

### Brass Lever Action Gate Valves



2", 3",  
4", 6"

### Piston Valves

Brass 4", 6", 8"

Flanged Brass  
4", 6", 8"

Flanged X Threaded  
Brass 4", 6", 8"

### Double Acting Pneumatic Actuator



4", 6" and 8" brass  
piston gate valves

### Betts Sliding Gate Valve



3", 4", 6" sizes  
Flange X Flange,  
and  
Flange X Thread

### Non-Bolted Ball Valves



2", 3", 4"  
sizes

### Poly Pro Ball Valve

Compact Pro 2"



Full Port  
1-1/2", 2", 3", 4"

90° With Handle 2"

## VAC TRUCK ACCESSORIES

### General Vacuum Pump Accessories



8JE  
9JE

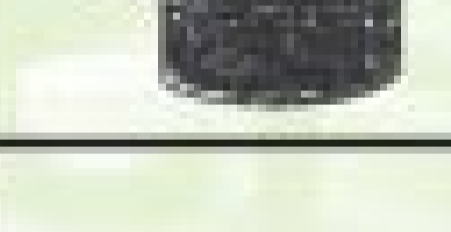
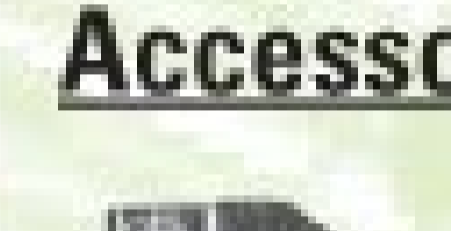
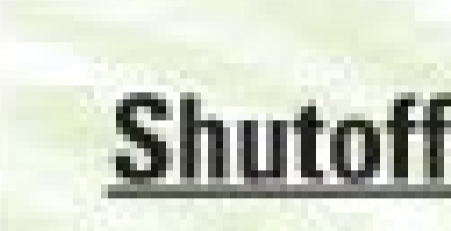
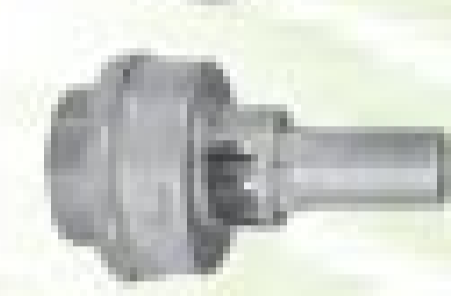

### Hatches, Manways, Manholes & Accessories



### Shutoffs & Accessories

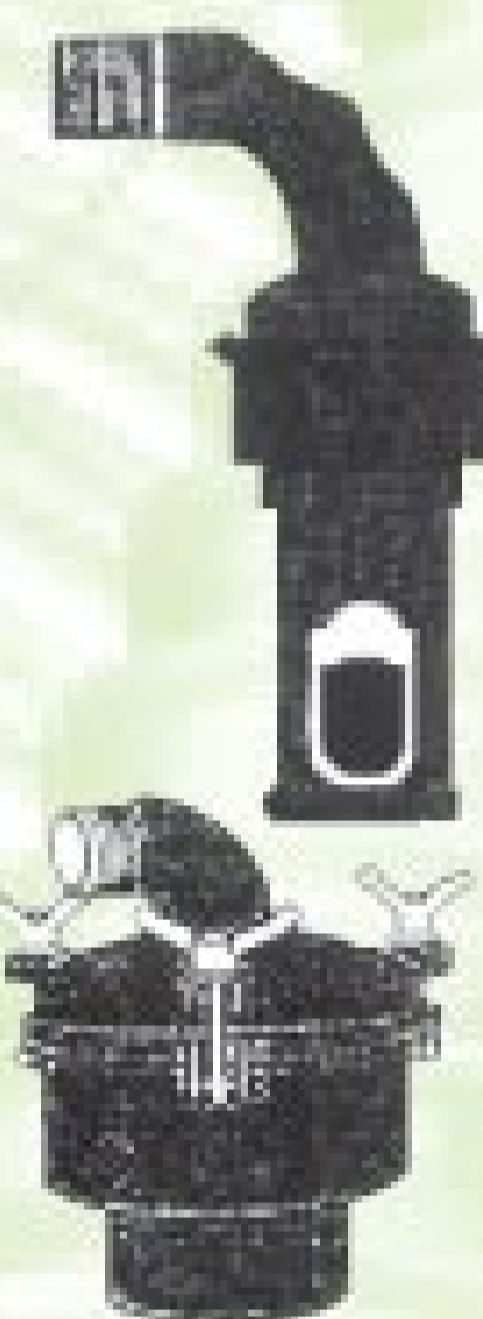

### Mufflers, Filters & Moisture Traps

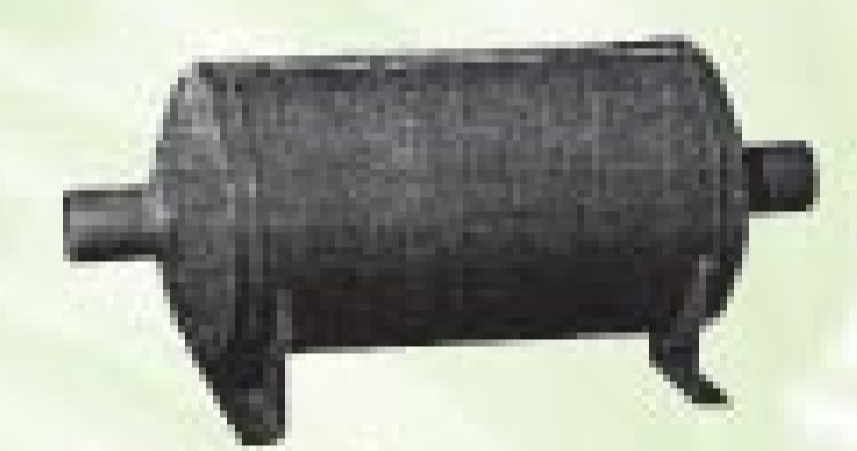

## SAFETY EQUIPMENT

### Gloves

PVC Sandy  
Grip Gloves



### 8" COM-PAX-IAL Blower

Blower



### Gas Monitor - GasAlertQuattro



### Confined Space Entry



Call For Prices Toll-Free  
**1.800.325.3730**

Call For A  
**Catalog**  
[www.milwaukeeerubber.com](http://www.milwaukeeerubber.com)

Milwaukee Rubber Products, Inc.  
P.O. Box 451 • Butler, WI 53007  
N52 W13319 Falls Creek Ct.  
Menomonee Falls, WI 53051

Call Toll-Free  
**1.800.325.3730**



# Back to School

## STAYING ON TOP OF ALTERNATIVE ONSITE SYSTEM TECHNOLOGIES AND LEARNING ABOUT GREYWATER RECYCLING ARE HOT TOPICS FOR OREGON'S INDUSTRY ASSOCIATION

Since incorporating in 1994, the Oregon Onsite Wastewater Association has focused much of its energy on an annual conference. In 2005, however, that focus expanded to support the state Department of Environmental Quality certification program. O2WA committee members developed the curriculum for associated classes presented at the conference and selected instructors from the membership.

About the same time, the association launched its scholarship program, raising money through a raffle and auction at each conference. In 2009, O2WA awarded a total of \$5,500 to four recipients from among 14 applicants. The amount was greater than in 2008.

While most members are installers, the organization represents all facets of the industry — service providers, pumpers, consultants, engineers, designers and regulators. They will meet again at Red Lion Jantzen Beach in Portland on April 9-10 for the 16th Annual Oregon Onsite Wastewater Association Conference. *Pumper* caught up with president Brian Rabe to learn where the association is going.



**“MANY URBAN OCCUPANTS OF A GREENER PERSUASION SEE RECYCLING GREYWATER AS ANOTHER TOOL TO HELP REDUCE THEIR CONTRIBUTION TO THE SANITARY SEWERS ... THERE WILL BE OPPORTUNITIES IN THE RURAL AREAS, PARTICULARLY IN ARID REGIONS AND WHERE WATER IS SCARCE. A PRIMARY ADVANTAGE WILL BE OFFSETTING THE SUMMER DEMAND FOR IRRIGATION WATER BY REUSING GREYWATER.”**

**Brian Rabe**

## *Pumper* Interview

By **Scottie Dayton**

**Pumper:** What are the hot onsite issues in Oregon?

**Rabe:** Until last year, they were certification and continuing education. The biggest thing in 2009 was the economic recession, which touched every member. The hardest hit were installers who built their businesses on relationships with building contractors. Those who diversified into pumping, repairs, and/or service work are fairing better.

**Pumper:** How advanced is the state in accepting alternative treatment technologies?

**Rabe:** In 2005, the code underwent significant changes, opening the door to numerous products. The first hurdle for all new manufacturers is to meet the NSF Standard 40 protocol, then to meet state code. I'm unaware of any non-approved systems operating as a pilot project. However, Oregon was home to the U.S. Environmental Protection Agency-funded La Pine Demonstration Project that used alternative treatment technologies in more than 49 new or retrofitted onsite systems.

**Pumper:** Did the 2005 legislation require maintenance contracts for all onsite systems?

**Rabe:** No, just for alternative treatment technology systems. Service providers must be certified by the DEQ and respective system manufacturers. Many pumpers or installers consider maintenance contracts an additional service. For a few, O & M is their specialty.

**Pumper:** What are some major issues facing the Oregon Onsite Wastewater Association?

**Rabe:** Growing and adapting to changes in the industry are probably our biggest challenges, which we address primarily through our conferences. Much of our activity throughout the year is preparing for it. We have an all-volunteer board, a handful of committee volunteers, and one part-time contract employee, making it difficult for us to juggle full-time jobs and our personal lives with the demands of the organization.

**Pumper:** How do you keep your conferences fresh so members come every year?

**Rabe:** For years, attendance grew slowly but steadily, with about half the registrants being regulators and designers, and half pumpers, installers and service providers. When the DEQ certification program swelled the installer ranks, we changed the conference's dynamics. Our sessions went from emphasizing issues and case studies of interest to regulators and designers to a dedicated track for installers and service providers. This year, we have one installer track, one O & M track, and one technical track.

One of the most popular classes in 2009 was by Gordon Hanna, an attorney from Garrett Hemann Robertson, P.C., in Salem, Ore. He talked about liens and other ways contractors can ensure they will be paid. The feedback was strong, suggesting that Hanna return to speak about contracts, and that's what he's doing this year.

**Pumper:** How will Rod Hansen's presentation, "Financing Repairs: Loan and Grant Opportunities for Low-Income People," be valuable to installers?

**Rabe:** Installers aren't expected to become loan advisors, but they can use the information to refer customers to the appropriate program. If the loan or grant is approved, the installer may get the job. Financing repairs is another tool to help businesses survive in tough economic times.

**Pumper:** What will you cover in two technical sessions on reusing greywater?

**Rabe:** When I attended the 2009 annual meeting of the American Society of Agronomy, Crop Science Society of America, and Soil Science Society of America, I heard a greywater presentation by a Colorado State University professor. That spiked my interest, so I spoke to her

about potential speakers and she referred me to two co-workers. Sybil Sharvelle will talk on the scientific benefits and limitation of reusing greywater and Larry Roesner, who has a greywater system at his house, will cover the practical nuts and bolts applications.

**Pumper:** Are Oregonians anxious to recycle greywater?

**Rabe:** As I understand the situation, Oregon's process probably will focus on the urban environment, where the political drive is. Many urban occupants of a greener persuasion see recycling greywater as another tool to help reduce their contribution to the sanitary sewers. However, the conveyance system has the most problems during the rainy season, and plants don't need irrigating when Mother Nature is providing plenty of it.

There will be opportunities in the rural areas, particularly in arid regions and where water is scarce. A primary advantage will be offsetting the summer demand for irrigation water by reusing greywater.

**Pumper:** Why did you add an Equipment Rodeo to this year's conference?

**Rabe:** Members attending the Washington Onsite Sewage Association conference and the National Onsite Wastewater Recycling Association Installer Academy reported that their Roe-D-Hoes were a fun competition of speed and dexterity, and another opportunity to interact with their peers. The event also allows local vendors to showcase their equipment.

**Pumper:** What is in the rule revision package that the Environmental Quality Commission recently adopted?

**Rabe:** Fee increases. For years, the building boom generated enough revenue to hide the fact that onsite permit fees weren't keeping up with inflation. They haven't increased in more than 10 years. If the DEP onsite program is to survive, people will have to pay more.

Oregon's legislature meets every two years, and the DEQ formed another committee to work on a rules revision package for the 2011 session. Among the changes we'd like to see is rewriting the language regarding residential and commercial onsite installations. The rules state that any contractor can install the tanks and pumps on commercial systems larger than 2,500 gpd, but only a licensed, certified installer can install the drainfield.

Meanwhile, contractors must be licensed and certified to install any part of systems smaller than 2,500 gpd. While not a common occurrence, certified installers are underbid by unlicensed contractors whose cost of doing business is lower because they don't have the expense of specialized certification and licensing. We want the language to read that all contractors must be certified and licensed to install these systems, regardless of size. It's a matter of fairness and professionalism.

Brian Rabe may be reached at 541/812-6639 or [brian.rabe@cascade-earth.com](mailto:brian.rabe@cascade-earth.com). ■

## Quality People Doing Quality Work

DOT Industrial Vacuum Hoist Units



Vacuum Septic Units

Aluminum or Steel  
Tanks in a Variety  
of Capacities



Portable Restroom Service Units



Mini Vac Trailers

500 Gallon Rear Open Basin  
Cleaner with  
Blower  
System



Slide-In Units



In Stock -  
Slide-In-Portable Restroom Units.  
Call For Details

# Marsh

INDUSTRIAL

P.O. Box 1107 - 135 E Mile Road - Kalkaska, MI 49646  
p: 231.258.4870 - f: 231.258.2019 - [sales@marshind.com](mailto:sales@marshind.com)

800.952.1537 - [WWW.MARSHIND.COM](http://WWW.MARSHIND.COM)

Check out the Marsh Industrial facebook page.  
See the progress of some of our units in the making.

What's  
Your  
Opinion



Pumper welcomes letters from readers responding to articles we publish or offering comments and opinions of interest to the industry. You can submit your letter by:

MAIL: Pumper, P.O. Box 220, Three Lakes, WI 54562  
FAX: 715/546-3786 ■ E-MAIL: [editor@pumper.com](mailto:editor@pumper.com)

All letters must be signed. Please limit your letter to 500 words or less. We reserve the right to edit all letters for length and clarity.



**Atlanta Rubber & Hydraulics**  
because you deserve more

*Look no further, for the highest quality products at the most competitive price*

**We offer a vast selection of Pumper & Cleaner products to meet your *specific* needs.**

- Kanaflex® Hose
- Quick Coupling Adapters
- Brass Valves
- Jetting and Sewer Hose
- Safety Products
- Gloves, Rain Suits, Boots, And more



**Value Adding Services:**

- *Special Packaging*
- *Custom Assembly Work*
- *Fabrication*
- *On-Site Troubleshooting*

**SPRING SPECIALS**

We are offering special pricing on our most popular Pumper & Cleaner products through **April 31, 2010**

Call 678-385-9645 for a price sheet

1640 D Sands Place Marietta, GA 30067  
Toll Free: 800-282-6272 PH: 770-955-5225  
FX: 770-955-2377 Email: sales@atlantarubber.com  
[www.AtlantaRubber.com](http://www.AtlantaRubber.com)



**KNOW-HOW TO GET YOU MOVING**

Now In **STOCK!**

**Stainless Steel Tank**



2010 International 7500, 3600 Stainless Steel, 500 CFM pump, 350 HP, Automatic trans., 18K front, 40K rear air ride.

**Call for price.**



2010 Ford, 2300 gallon Steel, Jurop pump, 260 HP, 3000RDS Auto trans, 12K front, 21K rear.

**\$79,900** Plus FET

*We Have Financing Available!*

Call Us Today Toll-Free:  
**888-201-9166**

[www.badgertruck.com](http://www.badgertruck.com)

**3600 GALLON STAINLESS STEEL**

Septic - Portable Toilet - Hoisted Vacuum - Slide-Ins  
NEW Units Available / Trade-Ins Accepted!  
Financing & Lease Plans



**We Have Money To Loan**



We are not affected by the economy. Conserve your working capital. Keep existing credit lines intact, and enjoy the security of knowing financing is there when you need it. We offer loan and leasing plans tailored to individual needs.

- Portable Toilets
- Sewer Equipment
- Pumper Trucks
- TV Inspection
- Water Jetters
- New and Used Equipment
- Vacuum Trucks

- ❖ Programs offer longer terms for older equipment
- ❖ We do start ups
- ❖ 90 Day Delayed Billing
- ❖ Seasonal Payment Programs Available

If you need equipment to grow and your bank said "NO," call "JIM THOMAS"

Prompt, no nonsense financing designed to meet individual requirements. Payment plans that are generally lower than other finance plans. With years of experience, we understand the competitive nature of your business. We're prepared to act quickly and decisively!

Toll-Free 877-333-4539 • [www.keycommercial.com](http://www.keycommercial.com)







**T&T Tools, Inc.**

Fax: 800.521.3260  
Email: sales@tandttools.com

**800.521.6893**  
**www.MightyProbe.com**

Call for a FREE Catalog



Call for a FREE Catalog

**HOOKS...**

- > Several different styles of heat-treated hooks are available
- > Top Poppers are great to open manhole covers
- > The Handy Hooks allow two handed use

**PROBES...**

- > Insulated, standard, and specialty soil probes
- > Metal shaft sizes: 3/8" round, 3/8" hex, or 7/16" hex
- > Replaceable tips are threaded on and hardened
- > A "slide" allows the handle to pound the shaft into the ground



# Aqua-Zyme Disposal Systems

*"From the Grease Trap to the Garden"*  
*- Dewatering & Composting -*

**#1 Box on the market!**

## The ADS Dewatering System

is built by a pumping company for pumpers. You are welcome to come and watch the 30 yard box dewater 20,000 gallons of grease trap waste and/or septic tank waste in only 2 hours!

By using the ADS dewatering system along with our Compost Facility, we have turned our disposal costs into a profitable venture!

**Call 979-245-5656 for Info!**  
**\$ Financing Available \$**

P.O. Box 489, Van Vleck, TX 77482 • www.aqua-zyme.com  
1-979-245-5656 • zymme@aqua-zyme.com • U.S. Patent # 6,364,122

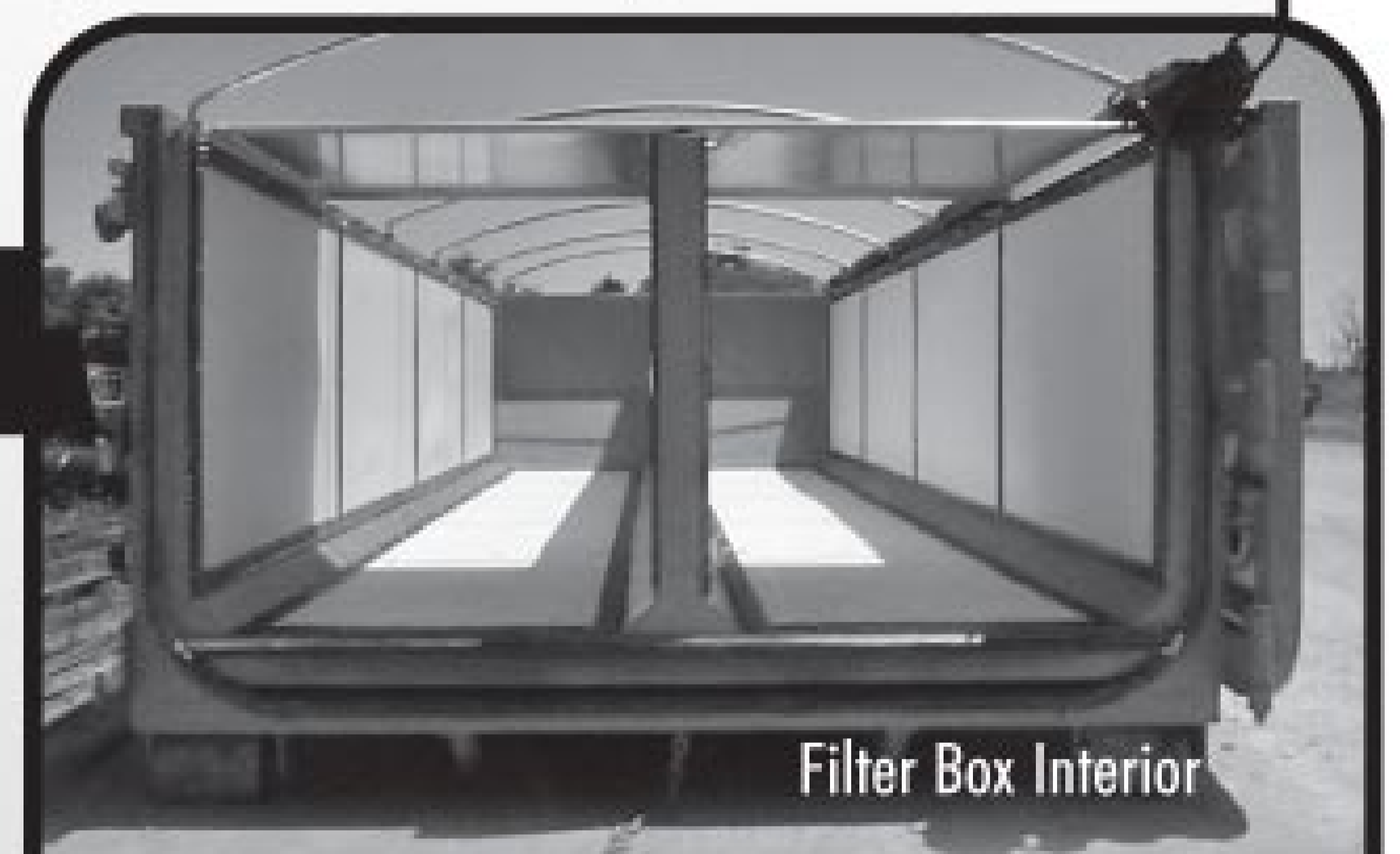

Filter Box Interior



Draining Down



# TankTec

**Tank Technologies & Supply Co. LLC**  
 Portable Restroom Service Trucks  
 Septic, Grease & Grit Trucks  
 Refined Fuel Trucks

## 888.428.6422

Follow us on **facebook**. search, "TankTec"



### Slide-In Tanks

300 Gallon (200/100 split)	\$7200 (Conde pump)
450 Gallon (300/150 split)	\$7900 (Conde pump)
550 Gallon (370/180 split)	\$9700 (Conde pump)

\*\*\*Add \$800 for Honda 9hp and Masport 106cfm pump

Aluminum Construction  
 Honda Gas Motor (5.5 hp or 9 hp)  
 Conde 70 CFM or Masport 106 CFM Pump  
 Whale Water Pump

**Completely Self-Contained and Ready to Work!**  
**Single Compartment and Custom Configurations Available**

2009 International 4300 M7  
 2000 Gallon

**\$82,575**

M7 • Automatic • Air Brakes  
 Dual Side Service  
 Masport HXL4V 156 CFM  
 DC-10 Water Pump



**Tanks Available in  
 Stainless Steel  
 or Aluminum**

**5 Portable Restroom Units in Stock!**

**3 Single Axle Septic/Grease Units in Stock!  
 5 Tandem Axle Units in Stock!**

2009 Freightliner M2  
 4200 Gallon

**\$117,225**

PLUS F.E.T.

Aluminum Tank  
 Automatic • 330 HP Mercedes  
 Wittig RFL100 Aircooled 400 CFM



Ask About In Stock Trucks • Pumps, Parts & Accessories • Call for Lease Payment Details  
 Aluminum or Stainless Steel • Tanks in Stock • Financing and Leasing Options Available  
 Dual-Use Options • Customize to Your Needs • PRS 800-2500 Gallon • Vacuum 1000-6000 Gallon



**Tank Technologies & Supply Co. LLC • 888.428.6422 • [www.tanktec.biz](http://www.tanktec.biz)**

Steve Nelson • [snelson@tanktec.biz](mailto:snelson@tanktec.biz)  
 Andy Nelson • [anelson@tanktec.biz](mailto:anelson@tanktec.biz)

Local • 763.755.8075 • Fax • 763.757.9788  
 10100 Quinn St. NW, Minneapolis, MN 55433

# What Pump Oil Are You Running?

## USING THE RIGHT LUBRICANT AND PROVIDING GOOD MAINTENANCE, PUMPERS REPORT THEY'RE KEEPING VACUUM PUMPS RUNNING SMOOTHLY FOR YEARS AND YEARS

*This feature in Pumper reports noteworthy conversations that take place in Pumper Discussion, an e-mail based forum for industry professionals sponsored by COLE Publishing. Pumper Discussion provides for the exchange of information and ideas on septic and drainfield installation and maintenance, trucks and equipment, portable sanitation, chemicals and additives, and much more. To find out more about Pumper Discussion, or to subscribe, visit [www.pumper.com](http://www.pumper.com).*

*Information and advice in Overheard Online is offered in good faith by industry professionals. However, readers should consult in depth with appropriate industry sources before applying such advice to a specific business situation.*

## Overheard Online

### Question:

What have you used for vacuum pump oil? I have been running NVE pumps on my trucks since 2002. I have used manufacturer-recommended pump oil and have not had to change the vanes yet. The pump is still producing quick and full vacuum. I talk to and hear that some pumpers use the same oil they run in the diesel engines. Some say 10W-30; some say synthetic; some say whatever is on sale. I have a Conde pump on a tank used for portable sanitation and was told to run a certain type of oil.

### Answers:

I bought a Jurop PN Series 5800 pump in 1988. I use NAPA 30-weight non-detergent motor oil. I have never done anything to this pump in 21 years. Works great to this day.



I would recommend 30-weight non-detergent oil in summer and 10-weight non-detergent oil in weather below freezing. This combination seems to work really well. Scented additives can cause problems like plugging lines and don't properly lubricate bearings.



I have a 1989 Jurop R200 and run 30-weight oil. It's still working every day and I've only replaced the vanes once. I'm a believer in using 20-weight oil in winter and 30-weight oil in the summer.



I've run a Masport pump at least 12 years and use Chevron GST 68

I would have to say that what people use in winter for oil is a direct map of where people live. If we try 30-weight in winter in northern Wisconsin, it will flow like tar at 10 degrees F below zero. So keep the outside temperature in mind when choosing oil.

turbine oil. I've never turned a bolt on the pump and have never run diesel fuel through it.



I've always used 68-grade hydraulic oil. It's constant viscosity. I've never used multigrade, for instance 10W-30, as it thickens as it gets hot. I've used the same pumps for eight years.



I run a Wittig pump, and I use the oil recommended by Wittig — regular, non-detergent 30-weight motor oil in the winter, 40-weight in the summer.



I would have to say that what people use in winter for oil is a direct map of where people live. If we try 30-weight in winter in northern Wisconsin, it will flow like tar at 10 degrees F below zero. So keep the outside temperature in mind when choosing oil.

## Is Pumping Woman's Work?

### Question:

I know pumping work is usually performed by men, but my husband got hurt so I took over for a while (actually it will be about a year pretty soon). I am curious to know if there are any women out there who do this work full time. Pull the hoses, pump, drive, etc.

### Answers:

I sold a man a rig several years ago and last year he passed away. His wife had no other choice but take up where he left off. She is doing just fine and enjoys it. Another lady in my area lost her job at a bank and went into pumping. Everyone thought that she didn't stand a chance (including myself). But I told her that if she ran into trouble and needed me, I'd help her any way I could. She has done very well and has only had to call me for help a few times. If you enjoy it, by all means don't let anyone tell you that you can't do it.



I have one female pumper and she is the best employee you could ask for. She's happy, great with customers. Whenever she enters a job-site, the men go out of their way to help her. When she turns up it's as if the seas have parted and there is a clear run right to the tanks. If she gets a flat, there are 10 guys fighting to help change the tire. She loves the job and the attention she gets from the work sites she visits. I would have three more of her.



A concern in hiring a woman would be a strength issue. In my area the lids can be up to 150 pounds, with some having no lifting handle. My guys have to pull those lids from holes 2-3 feet deep. My other concern is that a male homeowner will go out of his way to help a female with a heavy object. If that person hurts himself, you can bet they will sue you. My customers always offer to help, but my policy is to refuse the offer. ■

*Hands Down, Simply the Best.*

# Odo-Buster™ "C"

The Ultimate Portable Toilet Deodorant™

1  
Metazene®  
Neutralizes  
Malodor Molecules

2  
Deep Blue Non-  
Staining Dye

3  
Citronella Helps  
Control Flying  
Insects

4  
Powerful Odor  
Counteractant  
Fragrance

5  
Biocide Controls  
Growth of Odor  
Producing Microbes

**5 ingredients make this the best portable toilet deodorant you will ever use!**

**"Introductory  
Special"  
Call Today**

**1-800-556-0111**

292 Alpha Drive, Pittsburgh PA 15238  
412-252-7000 • [www.surcopt.com](http://www.surcopt.com)



**SURCO®**  
PORTABLE SANITATION DIVISION

WORLDWIDE EXPORTERS

# 27th TRUCKS INC.

8975 N.W. 27TH AVE. • MIAMI, FL 33147 • PH: 305.835.9030 • EMAIL: INFO@27TH-TRUCKS.COM

2 Year  
Factory Warranty  
on Pumps

5 Year Factory Warranty  
on Carbon Steel Tanks



**2005 FREIGHTLINER M-2**  
2500 Gallon Carbon Steel Tank



**2005 MACK VISION**

10 Spd, Double Frame, 4000 Gallon Carbon Steel Tank, New Jurop Pump LC420 Installed



**2001 PETERBILT 357**

Mileage Less Than 180K, 357 CAT Power, 8 LL Transmission, Heavy Duty Suspension, 46K Rear - 21K Fronts, 4800 Carbon Steel Tank



10 Year Factory Warranty  
on Aluminum Tanks



**(3) 2005 INTERNATIONAL 7600**  
2500-4000 Gallons



**2005 MACK VISION**

10 Spd, 350 HP, 4000 Gallons With Dumping System, Jurop Pump LC 420, 425 C.E.M.



**2007 STERLING**

12.7 Detroit, 150K Original Miles, 4000 Gal Steel Tank, Jake Brake, 450 Hp, 10 Spd

**WWW.27TH-TRUCKS.NET**

Contact Alan @ 305-457-8058, Armando @ 786-267-3026, David @ 786-236-9007

## Dewatering Made Simple.



The Flo Trend® Sludge Mate® and Poly-Mate® form an economical and simple to use sludge dewatering system.



The Poly-Mate® conditions sludge through the addition of polymer prior to the dewatering process which occurs in the Sludge Mate®.



**Sludge Mate®  
& Poly-Mate®**



These units are designed to dewater sludge from a multitude of waste stream sources including: water and wastewater treatment plants, septic tanks, car washes, industrial sumps and lagoons, grease traps,

rendering plants, and food processing plants. The Sludge Mate® and Poly-Mate® are available in a variety of sizes and configurations, and are built to custom specifications.



**Flo Trend Systems**  
707 Lehman St.  
Houston, TX 77018

800.762.9893  
713.699.0152  
Fax: 713.699.8054  
sales@flotrend.com

# Hungry for \$\$\$?



Manufacturing custom vacuum equipment for the past 20 years

**888-442-7829**

**Call GapVax® today!**

**Top Quality Hydro-excavators,  
Combination JetVacs,  
Industrial Vacuum Loaders and more!**

**[www.gapvax.com](http://www.gapvax.com)**



***Your one stop parts & accessories source!***

Check out our 2010 sales flyer on our website  
AND view our complete PartsExpress catalog!

# WEATHERFLEX EPDM



**DURABLE**

**FLEXIBLE**

**VERSATILE**

## SPRING SAVINGS:

**3" X 25 FT: 4 FOR \$385**

**3" X 33 FT: 3 FOR \$360**

**2" X 25 FT: \$59 EA**

- SHIPPING ADDITIONAL -

## POWER BOOSTER

INCREASE VERTICAL LIFT

OVERCOME:  
HEAVY SLUDGE  
DEEP LIFTS  
DISTANCE  
MORE

SPECIAL  
DISCOUNT:

**\$ 50  
OFF**

(POWER BOOSTER ONLY)



**CAPITAL RUBBER**

**(800) 258-3000**

**WWW.CAPITALRUBBERCORP.COM**

CALL US TO SEE HOW TO MAKE AN EXTRA \$2,000 PER MONTH



## WHIRLWIND™ AERATOR

The **STA60** and **STA80** are specifically designed for years of trouble-free service and are a superior replacement for all 60 and 80 model pumps on the market.

STA60 ....\$220

STA80 ....\$250

**Best Value!**

CARRIES A 2-YEAR WARRANTY

### Flagg-Air™ Model 340

HAS BEEN SOLD  
NATIONALLY SINCE 1992  
AND HAS A REPUTATION  
AS THE LEADER IN  
AERATION!

- 3450 rpm
- 1/4 hp, 115V
- Enclosed motor
- Stainless steel shaft
- High impact plastic parts
- Operates quietly
- 2-yr. warranty
- Fits in place of most original manufacturers' units
- Replacement parts available



**Best Value!** **\$350**

The Flagg-Air 340 does not carry the NSF seal. Check local and state regulations for approval in your area.



**R-5760 Blower**  
57 cfm.....\$375



**BULLET™**  
High Head  
Filtered  
Effluent  
Pumps

BP12...12gpm  
\$235  
BP20...20gpm  
\$255

**MEDO HEM LA-80**  
Linear Pump



with low pressure  
alarm & light,  
with on & off  
switch

**MEDO Piston**



LA-60  
LA-80B  
LA-100  
LA-120

**SECOH Diaphragm**



EL 60  
EL 80  
EL 100  
EL 120



0523  
1023

Rotary Vane  
Compressor

**Regenair®**  
R3105-12  
Blower

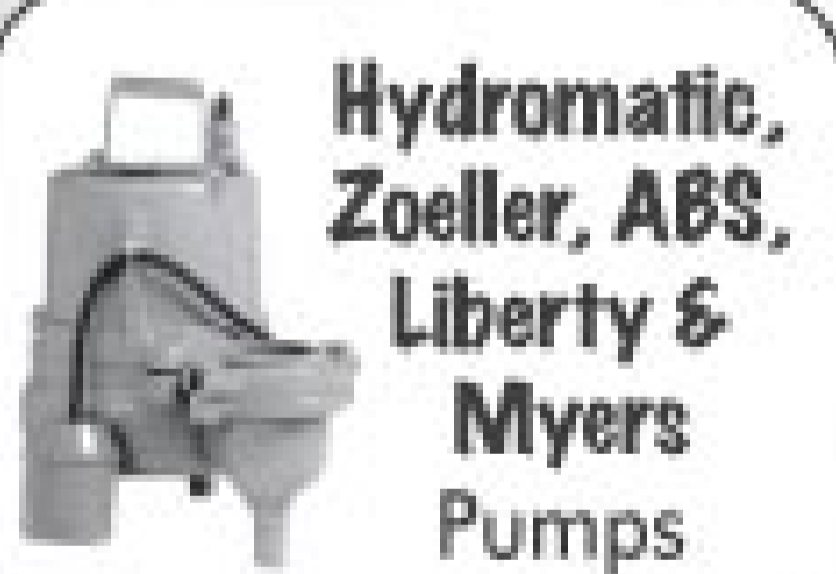

Hydromatic,  
Zoeller, ABS,  
Liberty &  
Myers  
Pumps

**Conde SDS 6**  
Engine Driven



Units available  
20 to  
180 cfm



**Moro PM80**  
Turbo 350 cfm

Moro Pumps: from 175 to 1642 cfm

toll free 1.800.536.5564 • 636.583.5564 • fax 636.583.6432  
e-mail [septic@fidnet.com](mailto:septic@fidnet.com) • web [www.septicserv.com](http://www.septicserv.com)



**Septic Services, Inc.**



# Pre-emission trucks in stock. While they last.

NEW AND PRE-OWNED SALES | RENTAL | LEASING | PARTS | SERVICE | BODY SHOP | FINANCING

If you're in the market for a refuse vehicle, make Rush Refuse Systems your resource. We have one of the largest inventories of work ready trucks in the country, representing the industry's leading brands. Whether you need to buy, rent or lease, we have a full spectrum of financial resources available. And, we support you through our Rush Truck Centers network of over 50 locations — with an extensive parts and accessories inventory, highly skilled ASE-certified service professionals and exceptional body shop capabilities.



## Peterbilt 340 Standard Vacuum Trucks

Automatics and standards are in stock and ready to go to work. Non-code 3600 gallon Pik-Rite tank. Masport HXL400WV liquid cooled pump, aluminum hose trays, internal primary to secondary piping for clean mount. 10 yr tank warranty standard. Options can be added before delivery. Compare our standard specs to anybody! **Call for pricing.**



### 2008 Peterbilt 365 with 4200 Gallon Oilfield Vacuum Tank

Standard transmission in stock and ready for delivery. CAT C13 430HP. Pik Rite 4200 gal steel tank. Masport HXL400WV liquid cooled pump. Aluminum hose trays. Options can be added before delivery. **Call for pricing.**



### 2009 Peterbilt 340 with 4000 Gallon Aluminum Vacuum Tank

Automatic or standard in stock ready to go to work. Imperial 4000 gal aluminum tank. Masport HXL400WV liquid cooled pump, Aluminum hose trays. Options can be added before delivery. Two Stage engine brake included. **Call for pricing.**

# 877-661-4511

Refuse Sales Team: Gregg Wilkinson | Jason Guzauskas | Jesse Fullilove | Ryan Johle  
refusesales@rush-enterprises.com | 8810 IH-10 East | San Antonio, TX 78219

# Refuse Systems



www.rushrefusesystems.com



# Dealing with Debt

**A difficult economy can mean strains on small-business finances. Take this advice to help keep debt from dragging your business down.**

By Fred S. Steingold

**T**hese days, many businesses are wrestling with finances or even struggling to stay afloat. The recession has hit small and mid-sized business especially hard. Along the way, some owners have been surprised to learn that they're personally liable for business debts. Their personal assets — home, car and savings — are at risk.

Other owners have planned ahead. If their businesses falter, their personal liability is limited. So how can you protect your own assets?

## Form an LLC?

For starters, look at the structure of your business. Is it a sole proprietorship? If so, you're personally responsible for all business debts, whether based on a contract or the result of someone being injured on your property or by a business vehicle.

The same is true if your business is a partnership. And here, each partner is personally liable for the business debts incurred by the other partners.

This is a good time to consider changing your business to a corporation or limited liability company, or LLC. Each of these formats will greatly limit your personal liability. Nowadays, most small businesses prefer to operate as an LLC. An LLC is easier to create, involves less paperwork, and gives you more flexibility. Your lawyer can help you decide whether a corporation or an LLC is best for you.

Even with a corporation or an LLC, you're not completely free of personal liability. For example, you'll be liable if you personally cause injury to someone or damage the person's property. The same is true if you personally guarantee a bank loan given to the business.

You can, of course, buy insurance to cover injury or property damage claims. And you can do your best to avoid giving personal guarantees, though that's tough to do if you need a bank loan. Banks fear that small businesses may run out of money.

Having a corporation or LLC won't protect you if you're careless in observing the distinction between yourself and your business. You can open the door to liability if you don't use the correct business name.

*Fred S. Steingold practices law in Ann Arbor, Mich. He is the author of Legal Guide for Starting and Running a Small Business and The Employer's Legal Handbook, published by Nolo.*



**No matter how tough things get, don't try to hide your business or personal assets. For example, don't transfer them to friends or relatives. Doing so can sometimes lead to fraud charges, both civil and criminal.**

And you're looking for trouble if you sign contracts for the business without stating that you're acting as an officer or agent of the business.

You also stand to lose if you pledge your home or car as security for a business debt. If your business doesn't pay the debt, the creditor may seize the property.

## Assign priorities

If your business is running low on cash, you'll need to decide which bills to pay first. Give your highest priority to payroll taxes — the sums you withhold from employee paychecks to cover income, and Social Security and Medicare taxes. Owners and officers of a business are personally liable for paying these taxes, called "trust fund" taxes.

Slip up, and you'll owe a penalty equal to the unpaid trust taxes, plus interest. If you don't pay the trust fund taxes, the IRS can seize not only your business's equipment, but also your personal assets. In some cases, the IRS can even charge you with a crime for failing to deposit the payroll taxes.

Your next highest priority is to see that your employees get their paychecks on time. If you get behind by even a few weeks, state law may give the government the right to close your business. There can be hefty penalties as well, for which you'll be personally liable if you're a sole proprietor or a partner.

## Don't hide anything

No matter how tough things get, don't try to hide your business or personal assets. For example, don't transfer them to friends or relatives. Doing so can sometimes lead to fraud charges, both civil and criminal.

And never, never lie on loan applications. If your financial troubles are deep, you may be tempted to conceal the financial condition of your business. This would be a huge mistake. Again, you would open yourself to fraud charges. And if you seek to have the debt canceled through a bankruptcy action, that won't happen. So tell it like it is.

To learn more about avoiding personal liability for business debts, read the new book, *Save Your Small Business: 10 Crucial Strategies to Survive Hard Times*, published by Nolo. Authors Ralph Warner and Bethany Laurence cover this and many other timely topics that can help a struggling business. ■

**Clear Computing Software Really Makes a Difference!**

**Reduce Your Expenses  
Be the Low-Cost Provider!**



**Lease or Buy – Call for Internet Demo  
(888) 332-5327 [www.clearcomputing.com](http://www.clearcomputing.com)**

**Going Green Saves You Money!**



# Septic Tank Riser, Lid & Safety Pan™

**FREE FREIGHT ON FULL CARTONS!**



## Tank Adapter Ring

New - Horizontal Safety Screw.

Safety Pan™ to Riser attachment with 6 vertical stainless steel screws.

Riser to Riser attachment with 6 vertical stainless steel screws.

Patent Numbers  
 5,617,679 &  
 5,852,901; other  
 pats. pending.

## Riser Lid

with Molded-in gasket.  
 Available in 12", 16", 20" and 24" diameters.

Concrete Lid w/handle

## Safety Pan™

Safety Pan™ available in 16", 20" and 24" diameters.

## Riser

For septic tanks. Stackable in 6" increments. Available in 12", 16", 20" and 24" diameters.

## Tank Adapter Ring

For mounting riser flush to top of tank when casting-in is not an option.

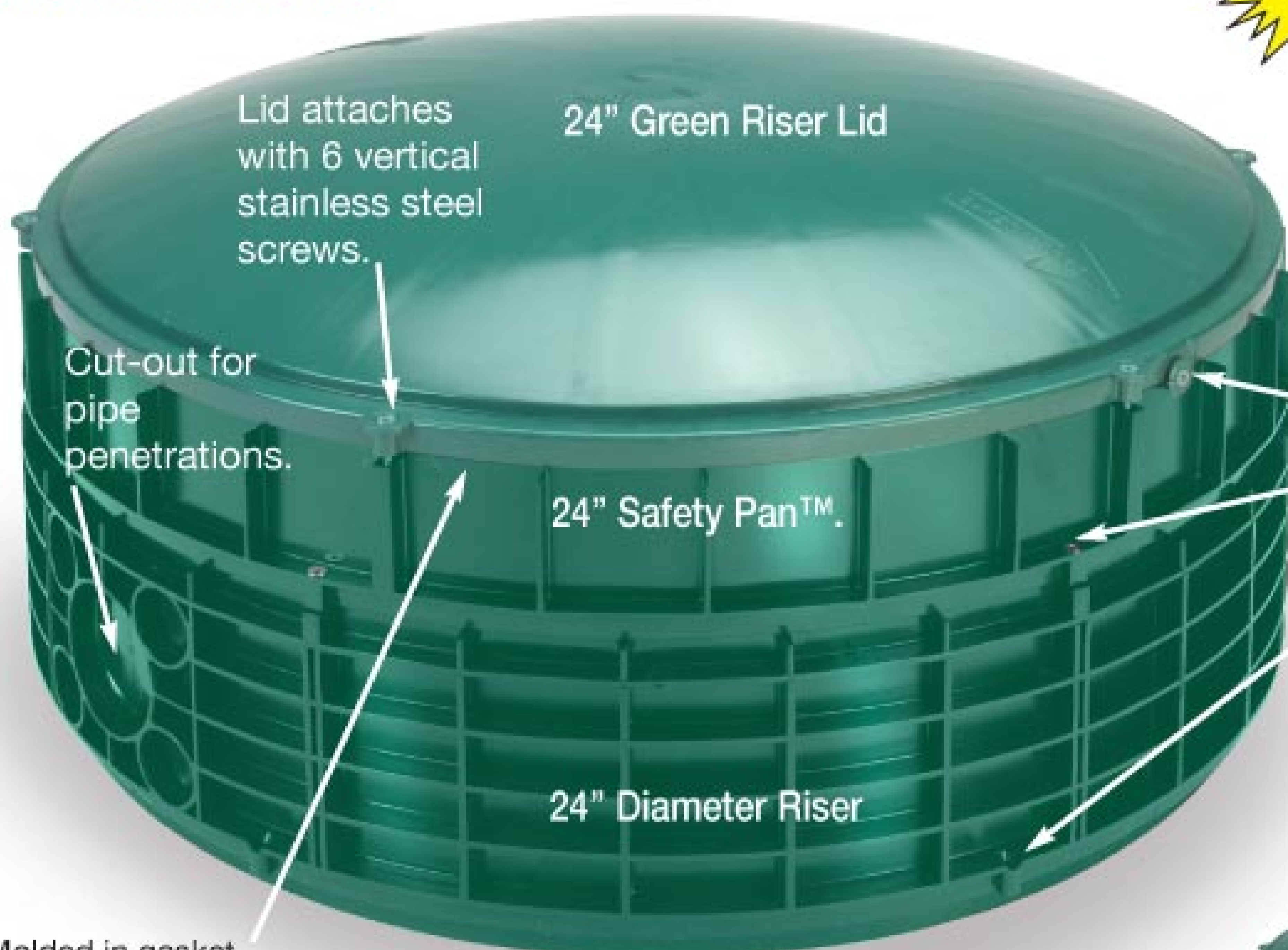

Available in 12", 16", 20" and 24" diameters.

## Effluent Filters

Patent Numbers  
 6,319,403; D 431,629; other  
 pats. pending.

800 GPD  
 ANSI/NSF  
 Standard 46

4" Sch. 40 &  
 SDR-35

**EF-4**  
 4" Filter

**EF-6**  
 6" Filter

1500 GPD  
 ANSI/NSF  
 Standard 46

4" Sch. 40 &  
 SDR-35

244 ft. of  
 1/16" filtration  
 area.

Gas/Solids  
 Deflector

## One-Piece Tank Seal

For concrete Septic tanks and D-boxes.  
 Accepts pipes from 1-1/2" to 4".  
 Mounts with or without concrete flash.



**TS-4-RUBBER TANK SEAL**  
 (will hold 10psi)  
**TS-4PRO TANK SEAL**  
 (will hold 5" vacuum)



Free Freight: 32¢

Patent No's  
 5,624,123  
 & 5,711,536;



# FRUITLAND VACUUM PUMPS

Eliminate your problems and your competition with one easy package.

All you do is bolt it on, hook it up and go to work. It's that easy.

Available for RCF 500 or RCF 370 packages in diesel, angle gear box, or hydraulic drive.



**Fruitland  
Eliminator  
Packages**



**Used and Proven by World's Top Liquid Vacuum Service Companies.**

**Fruitland Tool & Manufacturing**

**" Committed to Quality, Reliability, and Guaranteed Performance "**

Contact us today: **1-800-663-9003**  
Visit us @ **www.fruitland-mfg.com** For more info.

## Still Lending

**Stimulate your business with Center Capital.**

- **New and Used Equipment Financing**
- **Competitive Rates and Terms**
- **Direct Lender/No Hidden Costs**

Center Capital's Environmental Equipment Financing Division offers equipment leasing and financing services tailored to the unique requirements of the waste management and environmental industries. Unlike traditional lenders, our sales team has expertise in both financing and waste management. We understand the kind of payment plans that make sense for your industry, the equipment, and the day-to-day business issues you face.

When you work with Center Capital, you're partnering with professionals who understand your business and what it takes to help it grow.

**www.CenterCapitalCorp.com**

\*Center Capital Corporation is a subsidiary of Webster Bank, N.A., Member FDIC  
All financing programs are subject to credit approval.

Call toll free:  
Mid-Atlantic  
Jim Ellixson  
800-344-2224  
jellixson@centercapitalcorp.com

Mid-West  
Perry Siler  
800-772-9938  
psiler@centercapitalcorp.com

New England  
Andy Stephanou  
800-478-8882  
astephanou@centercapitalcorp.com

Northeast (New York City & all  
counties, Long Island & North Jersey)  
Robert Marino  
800-344-2224 (Ext) 12  
RMarino@centercapitalcorp.com

Southern  
George Passarelli  
800-585-9038  
gpassarelli@centercapitalcorp.com

Southeast  
Caleb Boyd  
866-247-4654  
cboyd2@centercapitalcorp.com

**PUTTING  
THE CASH  
WINNERS**

**\$500 Winner** Cam Giusti of  
Del Val Chemical

**\$300 Winner** Peggy L. Dean  
of Pit-Stop Portable Toilets

**\$200 Winner** Colton Kidd  
of Kidd's Septic Service, Inc

Thank you all for participating... special show rate  
of **5.5 for new trucks** running until  
April 30th, 2010.\*\*

  
**CENTER CAPITAL  
CORPORATION®**  
\*A Webster Bank Company

\*\*Rates and terms are subject to credit department approval



51 YEARS OF DEPENDABILITY

# TUFF-JON

## TJ Handy Stand

- Stand Holds 4 Waterless Gel Touch Dispensers Or Hand Wipe Dispensers
- Bag System Easy To Refill
- Dome Top, Base Has Holes For Stake Down
- Large 6 Gallon Base With Fill Cap And Drain Plug
- Comes In A Variety Of Colors
- Choice Of Black Or White Gel Dispensers
- Unit Dimensions: 18" x 18" x 52", 18 Lbs
- Comes Assembled



### Free-Standing Sinks



TJ Junior Single Free Standing Sink (20 gallons fresh water)

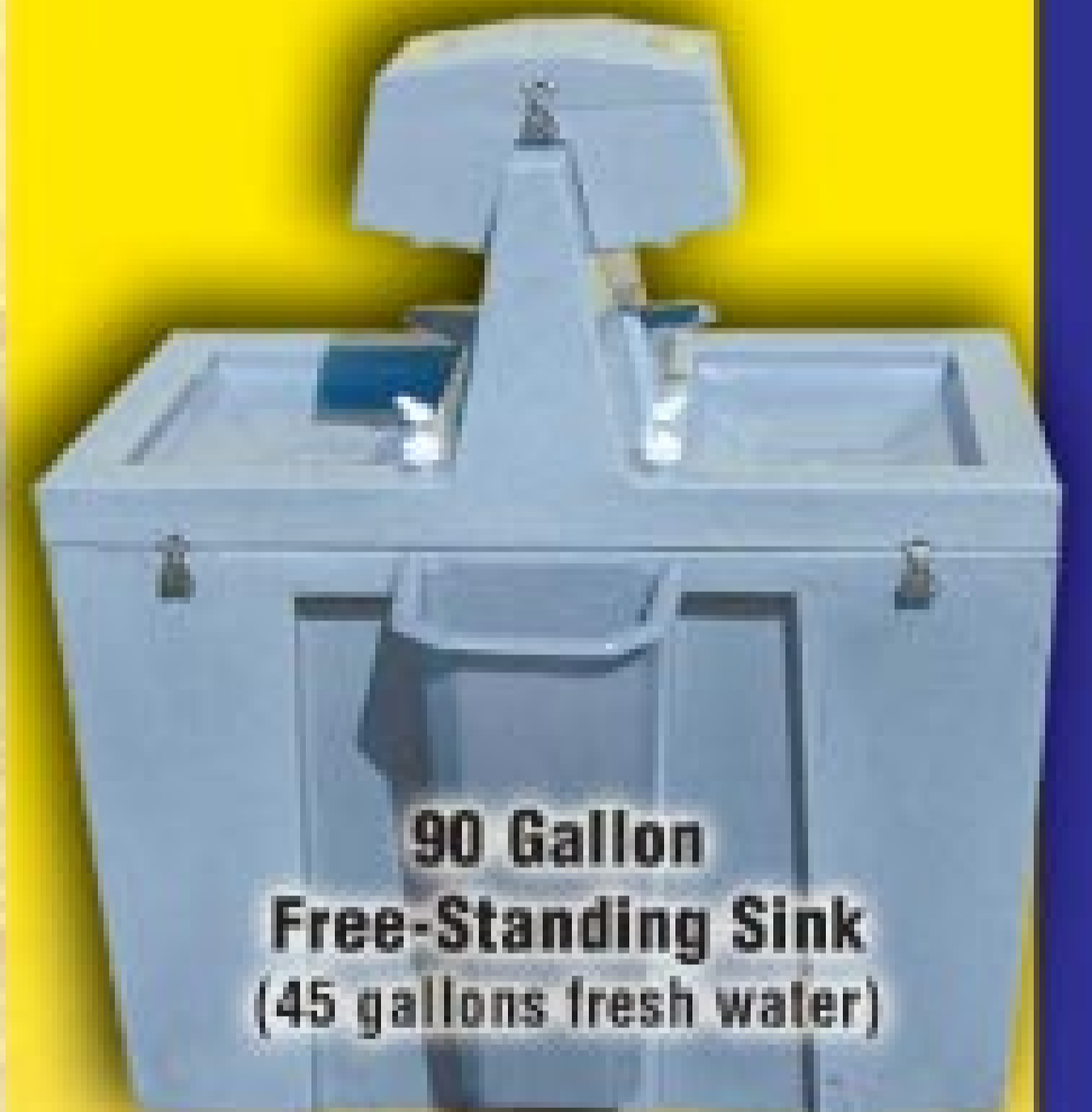

90 Gallon Free-Standing Sink (45 gallons fresh water)



7-1/2 Gallon Handwasher optional for the standard Tuff-Jon

**The TSF Company Inc.** | 2930 S St. Phillips Rd. | Evansville, IN 47712

Toll Free: **1-800-843-9286** | **812-985-2630** | Fax: **812-985-3671**

E-mail: **tsftuffjon@sbcglobal.net** | Web Site: **www.tuff-jon.com**



PORTABLE TOILETS | HAND WASH UNITS | ACCESSORIES

**Juggler™**

The **ONLY** **NSF** **CERTIFIED,**



**solid-liquid separator  
for grease traps and  
septic tanks that's  
SMARTER and GREENER  
than a standard  
Pumper truck!**

**labrie**  
environmental group

ISO  
9001  
2000

☎ 1 800 463-6638 | [www.labriegrup.com](http://www.labriegrup.com)  
Or contact Robert Lamarche at ☎ 1 514 919-0347  
Watch the Juggler video at [www.labriegrup.com](http://www.labriegrup.com)

## MEGA Holding Tank

1275 and 1600 Gallon Size



### Options

Lockable Lid • Level Alarm • Custom Fittings



**KentuckyTank**

Plastic Tanks and Accessories

**1-888-459-8265**

[www.kentuckytank.com](http://www.kentuckytank.com)

Make your own salt brine with ...  
The **BRINE-MAX** System



### Call now for Details!

Salt brine, the economical alternative to methanol

### LOW PROFILE Portable Holding Tank

100 • 210 • 300  
Gallon Sizes



Custom Fitting  
Locations at  
No Charge



On-Site Water System



Bulk Storage and Transport Tanks



Ball Valves and  
Cam Lock Couplers

**NORWESCO**

Distributor Since 1987

Nationwide Shipping Points



# TABSolute Perfection



Do you prefer controlling holding tank odors with tablets? Biodegradable, safe to handle and completely non-staining, PORTA-TAB quick-dissolve tablets surpass all competitors' tablets in performance and convenience.

- » *Coated for Easy Handling*
- » *Non-Staining EVERBLUE™ Color*
- » *Biodegradable and Formaldehyde-free*
- » *Powered by WAVE 2 Technology™ for Long-term Odor Control*

# Double Duty

## Pumpers share their tips on effective employee cross-training to get the most out of the workforce

By Mary Shafer

**A**s pumpers continue to diversify into fields related to septic service, they're asking crewmembers to take on new and varied jobs. That's when effective cross-training becomes critical.

Portable sanitation is one of the most common services pumpers migrate to, and placing and cleaning restrooms seems like a solid fit for a septic pumper. But the synergy should go beyond an understanding of vacuuming waste. Portable sanitation technicians usually have more customer interaction, attention to detail when cleaning and replenishing supplies, and attentiveness to changing surroundings on a construction site or on the grounds of an event.

So, what's a conscientious operator to do when cross-training, and what kinds of challenges might be expected in the process? A few pumpers who deal with this situation on a daily basis share what they've learned.

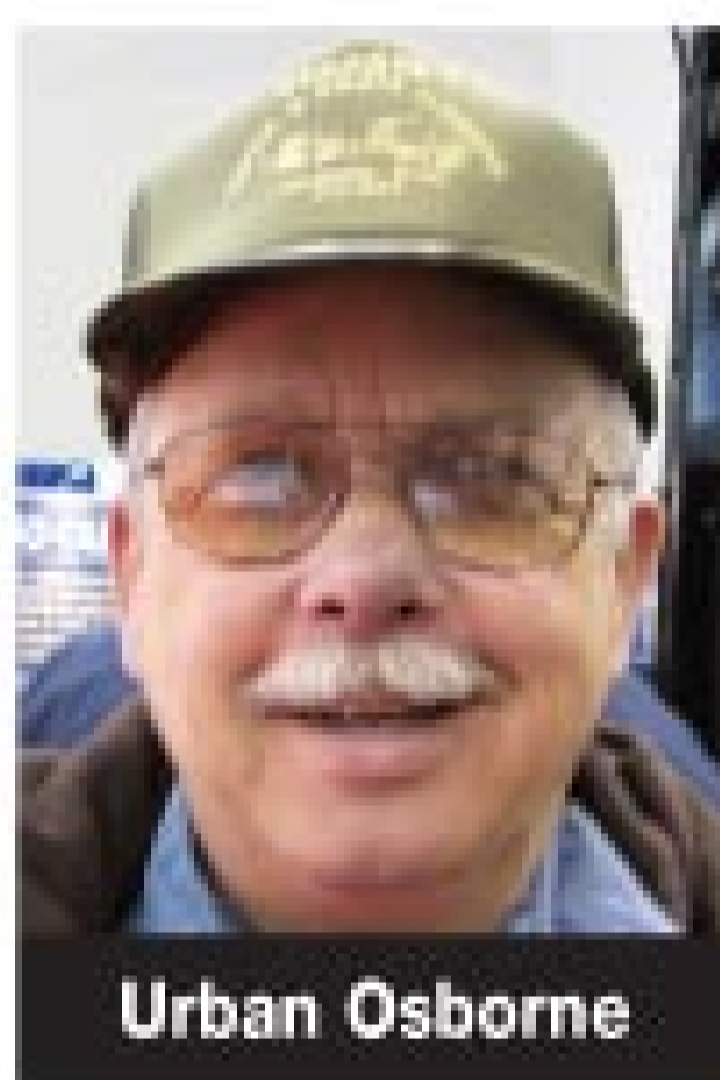

**Name:**  
Urban Osborne  
**Company:**  
Osborne Septic & Drain  
**Location:**  
Clintonville, W.V.  
**Employees:** 2  
**Years in Business:** 20

"It always takes a little more training to teach someone how to pump a unit and then keep it clean all at the same time," says Urban Osborne. "With septic drivers, if they can operate a vacuum truck, they can pump a tank. But on portables routes, you have to be able to figure out what the customer needs on

that particular job." Since Osborne has only two employees to service his 75 restrooms, everybody needs to be flexible and learn to do it all.

And, says Osborne, "what the customer needs" is not just about pumping, but also about keeping the unit clean in any environment or specific work conditions. "With most customers, cleaning is the big thing. If you can keep a restroom pumped and clean and smelling fresh, you're not going to have a lot of headaches and problems."

The regimen he teaches new hires varies according to customer needs. "Some like a little more paper, others like more chemicals, some want it to smell sweeter. You just need to pay attention, and that's what we train everybody to do."

For Osborne, that means part of the training is in listening skills. He tries to train employees to hear what a customer really needs, even if they don't come right out and say it. "Our drivers communicate weekly with the customers on the job, when possible," he says, and believes this regular communication is the secret to staying out in front of any issues.

**"With septic drivers, if they can operate a vacuum truck, they can pump a tank. But on portables routes, you have to be able to figure out what the customer needs on that particular job."**

Urban Osborne

Comments may be directed to Mary Shafer in care of Pumper. You may also e-mail [pipelines@pumper.com](mailto:pipelines@pumper.com).

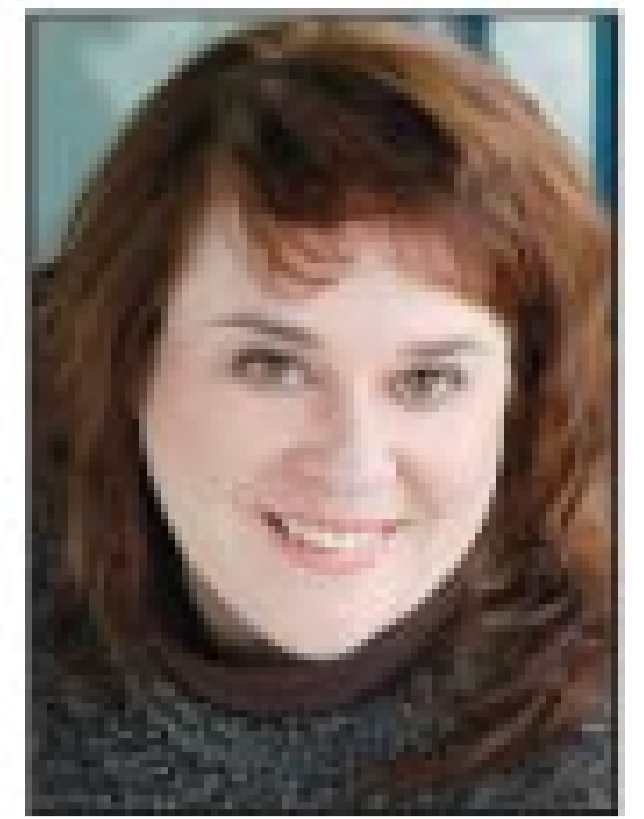

Osborne stresses the need to be responsive to what employees hear. "Our contractor customers are busy and can't always take time to talk with our drivers, but if they've indicated there's a problem, they'll talk to them and it will get solved that day."



**Name:**  
Allan Lundeen  
**Company:**  
Southern Septic Service  
**Location:**  
Sutherlin, Ore.  
**Employees:** 3  
**Years in Business:** 18

Allan Lundeen's company pumps septic systems, cleans drain and sewer lines, and rents and services portable restrooms on the Interstate 5 corridor, about 170 miles south of Portland, Ore. One of his crew of three is dedicated to septic and drains, one is a dedicated portables route driver, and one moves between septic

and portables service.

Lundeen also finds that his guys tend to want to stay in their areas of expertise. "If they're home, they're happy," he says. He doesn't find any other real challenges with cross-training, because his crossover technician usually doesn't get involved in placing units, only pumping and cleaning. To Lundeen, safety concerns for portables are pretty much the same as those involved in septic pumping, except working among crowds at special events. "And those I handle myself," he says.



**Name:**  
Tom Oshman  
**Company:**  
Beachstone Septic Corp.  
**Location:**  
Hawthorne, N.J.  
**Employees:** 5  
**Years in Business:** 3

"It's getting them to think," says Tom Oshman, whose company, Beachstone Septic Corp., shares customers with its alter-ego, BS Portapotty in New York City's northwest suburbs. "Getting them used to the fact that there's a system, and they need to follow the system."

His frustration is that "after they've been on the job a while, everybody seems to want to do things their own way, and it's like they're working backwards and doing twice the work. If you've got somebody who's got a lot of experience and has been (servicing portables) long enough to have worked out the bugs — they should listen to the experienced guy, at least in the beginning."

Oshman says he's pretty firm about insisting that new hires perform route tasks exactly as they've been taught. He says there's value in systems designed for efficiency and high standards, and they should be respected by those still learning the ropes. More than that, he says, "This is what the customer has come to expect, and that's what should be delivered."

Oshman does find most vacuum service techs prefer not to venture out of their comfort zone. "But then you'll have another guy who's willing to do anything," he says. This attitude, he believes, indicates someone who understands his job as just a single part of a total business. "That's the guy I'm looking for," he says. ■



J & J provides operators with the most advanced Technology In Odor Prevention & Elimination.

CALL TODAY and discover how we can help you.



Since 1967



# J-DISKS

fragrance enhancers



Concentrated Air Freshener Disks

Made In The USA

J&J Chemical Co.

J&J East - Athens, GA  
J&J West - Moab, UT

706-546-7069  
fax 706-546-7178

1-800-345-3303  
[www.jjchem.com](http://www.jjchem.com)

100% Biodegradable

Non-Toxic



# EVER GREEN

Portable Toilet Treatment

The Natural Solution for Portable Toilets

Ecologically Friendly



**100% MONEY BACK GUARANTEE**

If for any reason you are not completely satisfied with any product from J&J Chemical Co., you may return any unused portion for a full refund.

**TOICO**  
INDUSTRIES  
"YOUR ONE STOP SOURCE"

**1-888-935-1133**  
[www.toico.com](http://www.toico.com)

YOUR ONE STOP SOURCE FOR PORTABLE RESTROOM PARTS AND SUPPLIES

# Septic-Scrub™

**Used by More Professional Pumpers to Increase Their Business**

Backed By Science ■ Proven with Experience ■ Many Satisfied Homeowners

Septic-Scrub™ is a superior product for the maintenance and restoration of septic system drainfields. Customers appreciate that it is environmentally safe, contains no organic chemicals and does not produce any toxic by-products. Most importantly,

**Septic-Scrub works.**

It breaks down sulfide buildup in the biomat and soil to allow for better water absorption.

Learn more about Septic-Scrub at [www.arcan.com](http://www.arcan.com).

**arcan**

P.O. Box 31057  
Clarksville, TN 37040

For information on increasing sales and providing a valuable service to your customers, call Arcan Enterprises at **888-35ARCAN (352-7226)**

# ART'S TRUCKS & EQUIPMENT

View Our Entire Inventory Online: [www.artstrucks.com](http://www.artstrucks.com)

3001 West Expressway 83  
McAllen, Texas 78503  
956.686.2326 Fax 956.686.5179

**1.800.292.7007**  
[www.artstrucks.com](http://www.artstrucks.com)

**1998 Ford Jet Rodder Truck,**  
Cummins 5.9L Diesel, 7 Spd. Trans.,  
A/B, Vactor VFH1580 Jet Rodder,  
PTO Operated, 1500 Gal. Tank,  
3000 PSI Lot #2915992 - \$22,500



**2002 STERLING Combo Sewer Cleaner Truck,** CAT 3126 Diesel Engine, Automatic Transmission, A/B, A/C, Vac-Con Sewer Cleaner, J. Deere Rear Diesel Engine, 44,391 Miles, Lot #2815806 - \$75,500

**1999 VOLVO Combo Sewer Truck,** VOLVO-275 HP Diesel Engine, Allison 3560 Automatic Trans., A/B, A/C, 55,604 Miles, Vac-Con Sewer Cleaner, John Deere Rear Diesel Eng., Lot #2815680 - \$59,500



**1995 International Combo Sewer Truck,** Int. DT466 Diesel Engine, Allison Automatic Transmission, A/B, A/C, Vactor 2103 Sewer Cleaner, PTO Operated, Ex-Municipal Truck, Lot #2915979 - \$39,500



# TRANSPORT TRUCK SALES, INC.

**Ask for Scott or Frank – 888-395-7551**  
**After hours call Scott at 816-590-4076**



## What Does It Take To Be A "Qualified Chassis"?

- ✓ Pass our 12 point checklist. (We send this out with every quote!)
- ✓ Pass a D.O.T. certified inspection!
- ✓ Pass the warranty inspection!

## What Does All This Do For You?

- ✓ Nationwide drive train warranty for 2 years/ 200K miles! (restrictions apply)
- ✓ A tough truck that is ready to work as hard as you do!

**YOUR TRADES ARE WELCOME!**

**Searching For A Brand New Chassis?**  
**We Have Them In Stock!**



**2002 Freightliner FL-112**, CAT C-10 350 HP, 9 spd, jakes, 14,600# fronts, AC, double framed, new 3600 gallon alum. vac tank, new Masport HXL-400 vac pump.

**Call For Pricing!**

**2-YEAR 200,000 MILE DRIVE TRAIN WARRANTY**



**2002 Peterbilt 330**, Cat 300 HP, 9 spd, AC, 33# GVW, new 2300 gallon steel vac tank, new Jurop PN-84 vac pump.

**Call For Pricing!**

**2-YEAR 100,000 MILE DRIVE TRAIN WARRANTY**



**2000 Freightliner FLD120 Severe Duty**, 12.7L Detroit 430 HP, 13 spd, jakes, double framed, 18# fronts, 46# rears, new 3360 gallon steel vac tank, new liquid cooled HXL-400 Masport vac pump.

**Call For Pricing!**

**2-YEAR 200,000 MILE DRIVE TRAIN WARRANTY**



**2001 Mack CH613**, E-7 300 HP, 10 spd, AC, double framed, new 3360 gallon steel vac tank, new liquid cooled HXL-400 Masport vac pump.

**Call For Pricing!**

**2-YEAR 200,000 MILE DRIVE TRAIN WARRANTY**



**IN PROGRESS**

**2005 Kenworth T-300**, Cat 250 HP, 6 spd, AC, NON CDL, new 1800 gallon steel vac tank, new Jurop PN-84 vac pump.

**Call For Pricing!**

**2-YEAR 100,000 MILE DRIVE TRAIN WARRANTY**



**IN PROGRESS**

**2004 Peterbilt 385**, Cat 430HP, 10spd, jakes, AC, new 3360 gallon steel vac tank, new liquid cooled HXL-400 Masport vac pump.

**Call For Pricing!**

**2-YEAR 200,000 MILE DRIVE TRAIN WARRANTY**

**Delivery Available Anywhere in the Lower 48!!**

# Industry NEWS

## Godwin Pumps Names Managers

Godwin Pumps has named Will Buddin manager for its Raleigh, N.C.-based rental branch and Bill Price to the newly-created position of asset, logistics and transportation manager, based in Bridgeport, N.J. Buddin has seven years of industry experience; Price has 20 years of industry experience.



Will Buddin



Bill Price

## Planet Care Acquires Eco-Pure

Planet Care Inc. has acquired the assets of Eco-Pure Inc., Fort Myers, Fla., and relocated all product manufacturing, including a 180-inch swing rotational molding machine, to Pulaski, Va. The company's initial product offering will consist of the Eco-Pure peat moss biofilter and Eco-Pure polyethylene septic and pump tanks.

## Earth Friendly Adds Sales Managers

Andy Gosner and Rick Hayes have joined Earth Friendly Chemicals as regional sales managers. Gosner will manage the East Coast region and Hayes will manage the Midwest.



Andy Gosner



Rick Hayes

## Complete Group to Distribute Five Peaks Products

The Complete Group, Perth, Australia, has secured international distribution rights for Five Peaks Technology products. The new distribution company will be called Five Peaks International. A portable restroom rental and services company, Complete Group has been a primary distributor of Five Peaks products in Australia and New Zealand for six years.

## Dragon Products Launches New Web Site

Dragon Products Ltd. has launched a comprehensive Web site with information about its expanded capabilities. The site, [www.dragonproductsltd.com](http://www.dragonproductsltd.com), provides an overview of Dragon equipment and services, including tanks, trailers and pumps, as well as spare-parts inventories, financing options, technical assistance and training.



## SouthWaste Acquires Florida Processing Facility

SouthWaste Services LLC, Houston, Texas, has acquired Central Florida Disposal Interests, a liquid waste processing facility near Orlando, Fla. Terms of the transaction were not disclosed. ■

# TRI STATE TANK

[www.tristatetank.com](http://www.tristatetank.com)

*The Industry's  
FIRST CHOICE!*

**IN STOCK!  
Vacuum Service**



**Sewer / Septic  
Grease / Grit  
& Restroom  
Trucks**



**BUY IT NOW! \$99\***  
**'Guaranteed Credit Approval'**

\*Per month until August 2010, thereafter regular payments for 60 months with no residual buyout.

**888-281-9965**

Fax: 913-279-3151 [phodes@tristatetank.com](mailto:phodes@tristatetank.com)

Irrigation fittings are for irrigating – NOT vacuum.  
How many dollars are you spending **SUCKING AIR?**

Industry-proven, quality vacuum couplings from Bandlock will put money into your pockets.

4" to 12" Male Coupler    4" to 12" Female Coupler    Steel Crown 4", 6" and 8" Press End    Hazardous Material Profile Gaskets (Safety)    Rubber Gaskets

6" and 8" Aluminum Weldon    Aluminum & Steel Pipe

4" and 6" High Abrasive Bulk Nozzles    Special "Y" Reducers    BANDLOCK Couplers    Close Tolerance Couplers And Fittings Bring "Safety" To Your Work Place.

EZ Lift Clamps    Standard & International 4" to 12"    Wet Valve, 6", 360° Injected    Male and Female 4" to 12" End Plugs

**BANDLOCK Reducers**

**BANDLOCK Corp.**

**MADE IN THE U.S.A.**

Call or fax today to get your catalog!  
**1-800-659-2978**  
[www.amesbury.com](http://www.amesbury.com)  
Superior "Quick" Connect Vacuum And Pressure Couplings And Accessories

# NVE

National Vacuum Equipment

800-253-5500  
www.natvac.com

# SSHHH!!!!

## Lose The Noise Keep the Performance

*From the Leaders in Blower Technology,  
finally all the benefits of a blower  
without the noise.*

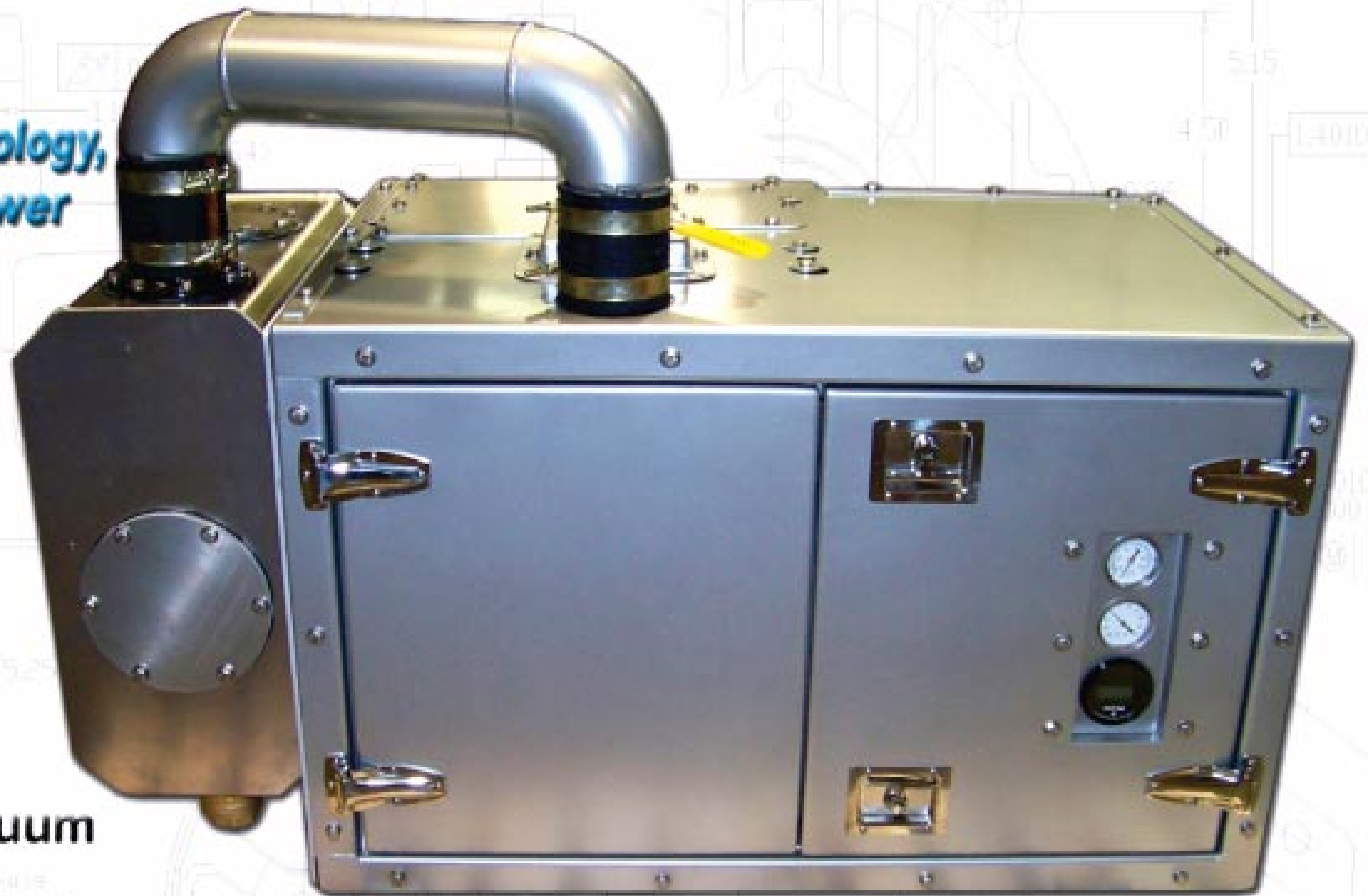

### Features:

- Continuous Duty at Full Vacuum
- DB Level - Low to Mid 80's
- Environmentally Friendly - No Oil Mess
- Designed, Built, & Supported in the USA
- Frame Mount Aluminum Moisture Trap
- Intake Air Manifold

# CHALLENGER

## PRO PAK PLUS

### BY NVE



# Fill 'er Up!

**With proper soil treatment system design, effluent should rise to the top of the trench rock or other distribution medium before flowing to a second trench**

By Roger E. Machmeier

**Q I believe drainfields start ponding when the user of the onsite system adds too much water to the drainfield. With a well-maintained septic tank biomat, I believe hydraulic conductivity tends to stabilize at approximately 0.20 gpd/sf, based on a scientific analysis of the flow into a soil. If the owner has 100 square feet of trench bottom, they can drain 0.20 x 100 = 20 gpd. Most homes would need 500 square feet of trench bottom to avoid ponding. What are your comments about ponding and drainfield sizing?**

**A** I agree ponding will take place in the bottom of the soil treatment area when the system is being used. However, this ponding will occur long before the owner "adds too much water to the drainfield."

I do not agree ponding should be avoided. As I indicated in the March issue of *Pumper*, the biomat develops in the bottom of a trench as the soil filters out suspended solids and pathogens (disease causing bacteria) in the sewage tank effluent. The biomat is a necessary part of the adequate sewage treatment by a soil. Unless the biomat forms at the rock-soil interface so that partially saturated flow takes place in the soil, there will not be effective pathogen removal.

An extremely porous soil that allows the sewage tank effluent to flow through without forming a biomat (and ponding) will not adequately treat sewage tank effluent and will not remove pathogens. An onsite soil treatment system must not be installed in such a soil.

As the biomat develops at the head end of the bottom of a trench installed in a suitable soil, ponding begins and the effluent moves along the length of the trench. When the entire bottom of the trench has developed a biomat and there is ponded effluent, the liquid level will begin to rise in the trench as more effluent is added.

Effluent begins to filter into the soil sidewalls of the trench and the biomat also forms at this trench-soil interface. If the soil treatment system is properly designed, the effluent level should rise to the top of the trench rock, or other distribution

medium, before any effluent flows to the second trench in the system. This is called sequential distribution.

How much effluent will be treated by a trench full of sewage tank effluent? This of course depends on the soil texture, the width of the trench and the depth of the sidewalls of the trench.

The following table of soil capacities to treat sewage tank effluent is used in Minnesota and many other states. I believe it to be quite similar to what the U.S. Environmental Protection Agency recommends. The table presents the Long Term Acceptance Rate of various soil textures as reflected by their percolation rates.

PERCOLATION RATES AND SOIL TREATMENT AREAS		
Percolation rate in minutes per inch	Soil treatment area in sq. ft. per gallon per day	Gallons per day per sq. ft. of treatment area
Faster than 0.1	Soil too coarse for sewage treatment	
0.1 to 5	0.83	1.20
0.1 to 5*	1.67	0.60
6 to 15	1.27	0.78
16 to 30	1.67	0.60
31 to 45	2.00	0.50
46 to 60	2.20	0.45
61 to 120	4.22	0.24
Slower than 120	0	

\*For fine sand and very fine sand with a percolation rate of 0.1 to 5 mpi. For trenches only, the bottom areas may be reduced if more than 6 inches of rock is placed below the distribution pipe: for 12 inches of rock below the distribution pipe the bottom area may be reduced by 20 percent; a 34 percent reduction for 18 inches; and a 40 percent reduction for 24 inches.

Using the above table for sizing the drainfield, a soil with a percolation rate of 0.1 to 5 minutes per inch (loamy sand) will treat 1.20 gallons per day per square foot.

If there are 24 inches of trench rock placed below the so-called distribution pipe, a 40 percent reduction in bottom area may be taken. Thus, 0.60 of a square foot will treat 1.20 gallons per day. Stated differently, the flow rate through the biomat of the loamy sand would be 2.0 gpd/sq ft. Only 10 square feet of trench bottom area in this soil would be needed to treat 20 gallons per day.

I understand your proposed value of 0.20

gpd/sq ft. was obtained from a mathematical analysis of soil texture using various assumptions as to flow conditions and the application of hydraulic flow theories. Has this value been tested in actual onsite systems?

You state 100 square feet of trench bottom would treat 20 gallons per day. This seems to be an extremely small value and there is no distinction for various soil textures. Your proposed value of 0.20 gpd/sq ft. is smaller than any of the values in the above table. It would oversize the loamy sand system by a factor of 10.

One note on the table should have further explanation. That figure is the design value of 1.67 sq ft/gpd for fine and very fine sand having a per-

colation rate in the range of 0.1 to 5 minutes per inch. When I was an Extension Agricultural Engineer at the University of Minnesota, we performed research on soils rated as fine and very fine sand. Onsite systems had been failing on these soils. The soil treatment systems had been sized using the value of 0.83 sq ft/gpd or an acceptance rate of 1.20 gpd/sq ft.

In our research we made accurate measurements of effluent flow into trenches installed in these soils. We found the trenches were able

to treat only 0.60 gpd/sq ft. The systems installed in this soil were only half as large as they should have been. That was the reason for the failure of the onsite systems.

Our research is the reason a separate value for fine and very fine sand has been added to the table for Long Term Acceptance Rates in Minnesota.

I hope my explanation will help you better understand the values commonly used for sizing soil treatment areas of onsite sewage treatment systems in Minnesota and other states. These values have been used successfully for many years. ■

*Roger Machmeier, Ph.D., P.E., retired as a professor and Extension Agricultural Engineer for the University of Minnesota and is a past recipient of the pumping industry's Ralph Macchio Lifetime Achievement Award. He answers reader questions regarding septic system operation and maintenance. Contact Machmeier through COLE Publishing by e-mail at editor@pumper.com, by fax at 715/546-3786; or by mail at P.O. Box 220, Three Lakes, Wis. 54562.*





## RMW Axial Radial Vertical Pump 7/8" Hollow Shaft - 6 1/2" Tall



RMW'S Have an Aluminum Manifold Head 275+ Hour Life.  
Fits 7/8" Vertical Shaft Gas Engines Up to 5.5Hp  
Includes Built-In Pressure Control Valve & Chemical Injector.

56713 2.0GPM @ 2400PSI RMW2G24P **\$106**  
\*Limited Quantities

## XJW Axial Radial Vertical Brass Head Pump 7/8" Hollow Shaft - 8 3/4" Tall

XJW's Have a Brass Manifold Head 750+ Hour Life.  
Fits 7/8" Vertical Shaft Gas Engines Up to 7HP.  
Includes Built In Pressure Control Valve & Chemical Injector



56722 2.2GPM @ 2600PSI XJW22G26P **\$99**  
56720 2.0GPM @ 2700PSI XJW2G27P **\$99**  
56724 2.4GPM @ 2600PSI XJW24G26P **\$99**

Limited Quantities

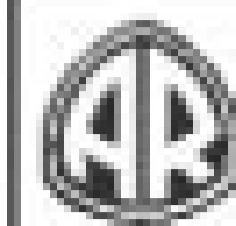

## RMV Axial Radial Horizontal Pumps 3/4" Hollow Shaft



RMV'S Have an Aluminum Manifold Head  
400+ Hour Life.  
Fits Most 3/4" Horizontal Shaft Gas Engines  
Up to 6.5Hp  
Includes Built-In Pressure Control Valve  
& Chemical Injector.

**NEW**

42.0162 2.5GPM @ 2500PSI RMV25G25P **\$99**  
42.0162 2.5GPM @ 2700PSI RMV25G27P **\$109**

- \* Pressure Washer
- \* Jetters
- \* Up to 7000PSI

# 1-800-454-9274

- \* Engines
- \* Pumps
- \* Parts



## RSV Triplex Plunger Pump 3/4" Hollow Shaft



Our Best Selling RSV's Have a Full Brass Manifold.  
2000+ Hour Life  
Fits most 3/4" Horizontal Gas Engines Up to 6.5Hp.  
Includes Built in Pressure Control Valve  
& Chemical Injector

56755 3.0GPM @ 3000PSI RSV30G30P **\$159**  
56724 3.0GPM @ 3200PSI RSV30G32P **\$169**

Mix or Match Discounts 2 Saves \$10 / 3+ Saves \$20



## TPI Triplex Plunger Pump 3/4" Hollow Shaft



TPI Series Have a Forged Brass Head, 2500+ Hour Life.  
High Temperature Tolerance to 165 F. Deg  
Fits most 3/4" Horizontal Gas Engines Up to 6.5Hp.  
Includes Built in Pressure Control Valve  
& Chemical Injector

11846 2.88GPM @ 3000PSI - TP Bare **\$189**  
11839 2.6GPM @ 3000PSI - TPI- As Shown **\$199**

Inquire For Plumbing Options



## 3DX Triplex Plunger Pump



Cat 3DX Pumps Are Versatile & Can Be  
Converted To Work Upside  
Down for Right or Left Hand Outlet Discharge.  
The 3DX Series Have A Brass Manifold Head,  
3000+ Hour Life. Fully Re-Buildable  
and For a Limited Time Discounted Over 70%  
From MSRP

56988 2.7GPM @ 3000PSI 3DNX27GSI **\$199**  
Limited Quantities Available

## 5CP Gear Drive Triplex Pump



Double Your Pump Life!  
Longest Life Packing

"The Pump with 9 Lives" - 5 Year Warranty

52982 3.8GPM @ 3500PSI 5CP3130G1 **\$399**  
52986 4.3GPM @ 3500PSI 5CP3140G1 **\$439**



## TX Triplex Pump 4GPM @ 3750PSI



53833 TX1510A - UNL **\$279**  
54893 TX1510AP **\$299**  
Fully Plumbed Version



## EZ Triplex Pump 4GPM @ 4000PSI



Best Selling General Pump  
52892 EZ4040G **\$289**

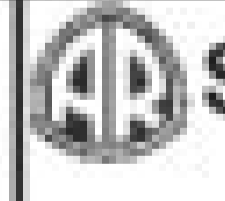

## SXMV Triplex Pump 4GPM @ 4000PSI



Best Selling Pump  
Sold by Water Cannon  
52708 SXMV4G40 **\$179**

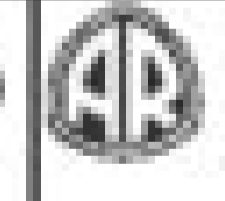

## RKV Triplex Pump 4000PSI Version



52716 4.0GPM RKV4G40 **\$219**  
52719 4.5GPM RKV4.5G40 **\$249**  
Limited Quantities

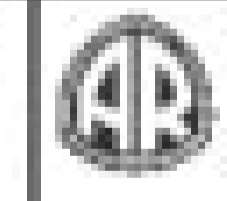

## GRKV Tapered Shaft 4GPM @ 3500PSI



GRKV4G35HV-F35 **\$399**

# Building the industry's finest quality tank trucks... One after another... after another... since 1923

## 1350 Restroom Aluminum Tank

Standard pumping system,  
dual service,  
hydraulic drive.  
2009 Ford 550  
Auto. transmission,  
two wheel drive

**\$71,700**



## 4200 Gallon Septic Tank

Wittig RFL100, air cooled, 400 plus C.F.M.  
2009 Freightliner M2  
Auto transmission, 330 HP Mercedes,  
18,000 lb. front / 40,000lb rear,  
exhaust brake, differential lock.

**\$116,225** Plus F.E.T.

Add \$5,500 for pusher axle installed.



## 1350 Gallon Restroom Stainless Tank

Standard pumping system, Dual service,  
hydraulic drive.

2008 Sterling Bullet  
Automatic transmission  
(2) wheel drive.

**\$72,000**



## 2000 Gallon Septic Pumper

Masport HXL75 pumping system, tool boxes  
2008 Toyota Hino Model 338 (Heavy Duty)  
6 speed trans., air brakes, exhaust brake.

**\$79,849**



# L.C. TANKS

LaVerne Charlet

**888-848-3727**

email: lctanks@bellsouth.net / fax: 270-898-4055 / 175 Cascade Dr, Paducah, KY 42003



**PORTA VAC**  
portable restroom vacuum trucks

Aluminum, Steel & Stainless Steel Tanks - 800 to 6,000 Gallon

**ALUMATANK**  
septic, grease & grit vacuum trucks

# HOSE ASSEMBLIES & ACCESSORIES

**'We Sell The Good Stuff'**  
Why buy anything else?

- LIQUID WASTE • PETROLEUM • BIO-DIESEL • WASTE WATER • GREASE TRAP • CHEMICAL
- SEWER CLEANER • JETTING • PRESSURE WASHER • MUNICIPAL VACUUM • LEAF & GRASS COLLECTION

# ABBOTT RUBBER COMPANY, INC.

1700 NICHOLAS BLVD. • ELK GROVE VILLAGE, IL 60007 • 800.852.1855  
E-MAIL [sales@abbottrubber.com](mailto:sales@abbottrubber.com) • WEBSITE [www.pumperhose.com](http://www.pumperhose.com)

Toilet Transporters

We Have Your Size

Industrial Duty Comfort Station

Ideal For: Factories, Refineries, Mines, Job Sites  
Disaster Relief, Fires, Emergency Services

1 to 24

Find out why more people trust Explorer to deliver...

- ✓ More Space
- ✓ More Hygiene
- ✓ More Comfort
- ✓ More Satisfaction

Contact an Associate In Your Region ...

Alberta

Ted Hoover  
Crossfield, AB  
Tel: (866) 587-7262  
Fax: (403) 946-4110

Florida

Steve Bale Ent.  
Apopka, FL  
Tel: (407) 822-3997  
Fax: (407) 822-3998

California

Plumas Sanition  
Portola, CA  
Tel: (530) 832-0370  
Fax: (530) 832-0373



Ontario

McKee Technologies  
Manufacturer  
Elmira, ON  
Tel: (866) 457-5425  
Fax: (519) 669-8331

Minnesota

Satellite Industries  
Minneapolis, MN  
Tel: (800) 328-3332  
Fax: (763) 553-1905

Colorado

Columbia Sanitary  
Golden, CO  
Tel: (303) 526-5370  
Fax: (303) 526-9686

Texas

Tom Woyt  
Jacksonville, TX  
Tel: (903) 586-6493  
Fax: (903) 541-0874

EXPLORER

Sales Associates  
Needed in  
Selected Areas

explorertrailers.com  
1-866-457-5425

The Simply Better choice for Truck Mount Pumps



753LN

Independent LN Cooler

A liquid normalized (LN) Wally pump eliminates cold winter starts, and hot summer overheating.



wallenstein  
vacuum . pumps

Available Nationwide through Original Equipment Manufacturers

If you appreciate heavy duty, low RPM vacuum pumps that outperform the competitors, consider a Wally for your next septic, industrial or sanitation truck. Call today to learn more about why we say simply better.



Always in Stock  
Master Importer

• STEM • LEVER • PRESSURE RELIEF • BALL



1-800-801-6663

Locate a Tank Manufacturer in your Area  
OEM Inquiries Welcome

EM elmira machine industries inc.



septictrux  
CUSTOM • PAYLOAD



Because every truck is different...  
We listen to what you want, and work together to fit your next truck into your operation, with prices more affordable than you might think!

vacutrux.com  
1-800-305-4305

only from  
vacutrux

Let us customize a solution that fits YOUR needs.





# Classy Truck of the Month

## Raider Rooter Boynton Beach, Fla.

This 2005 Mack Vision with 3,600-gallon U.S. Tank steel tank, built out by National Truck Center in Miami, is the latest addition to the vac service fleet at Raider Rooter. The Mack runs a 330-hp E7 engine tied to a 10-speed Eaton Fuller transmission, serving both residential septic tank and commercial grease trap jobs. Built on a double frame, the rig has an aluminum tool box, three 4-inch intake valves and a 6-inch dump valve. It gets suction power from a Jurop LC420 water-cooled pump. The truck features custom paint and lettering, aluminum wheels and hose trays, which are bolted on for easy replacement, and handy work lights for nighttime runs. The inside is freshened with new bucket seats, stereo, AC and cruise control. The distinctive pink and yellow lettering, by 3rd Street Signs, is used on all Raider Rooter trucks. ■

### SHOW US YOURS!

Got a truck with real WOW appeal? Show it off to Pumper readers — and to the whole world through [www.pumper.com](http://www.pumper.com)!

Send photos of your truck after it has been lettered with your company name. Any industry-related truck is acceptable. Please limit your submission to one truck only.

Your submission must include your name, company name, mailing address, phone number, and details about the truck, including tank size, cab/chassis information, pump information, the company that built the truck, and any other details you consider important. In particular, tell us what features of the truck help make your work life more efficient and more profitable. E-mail your materials to [editor@pumper.com](mailto:editor@pumper.com) or mail to Editor, Pumper, P.O. Box 220, Three Lakes WI 54562. We look forward to hearing from you!

### Seal it Tight! Seal it Easy! Seal it Fast!

- Easy 10 minute installation!
- Secure fit for all systems!
- Made & sold by septic installers!
- Prevent ground water infiltration and save money at the same time!

1  
Apply foam sealant to tank.

2  
Place ring over opening and apply foam.

3  
Place plastic maintenance pipe on ring.

4  
Install lid.

**For more information, call us today!**

**BrenLin Company, Inc**  
Manufacturers of Seal-R™ Products  
Herman, MN  
**888-606-1998**  
Fax: 320-677-3001 • E-mail: [brenlin@frontiernet.net](mailto:brenlin@frontiernet.net)  
[www.seal-r.com](http://www.seal-r.com)

**Seal-R™ Lids** Available in 12", 15", 18", 24", 30", 36"

**Seal-R™ Rings** Available in 18", 24", 30"

**Inner Safety Lids** Available in 18", 24"

Seal-R™ Lids can be personalized



# Longhorn Tank Company

[www.longhorntank.com](http://www.longhorntank.com)



Truck Mounted Tanks for Septic,  
Portable Toilets,  
Grease Traps, Etc.

Aluminum, Stainless, & Steel Vacuum  
Trailers in any Size

Call or Email Us For a Quote Today

800-422-9840

[sales@longhorntank.com](mailto:sales@longhorntank.com)

PO Box 1147 Gravette, AR 72736

Fax 479-787-6935

## 1000 Gallon Trailer Mounted Vacuum System



## EXPERTS IN PORTABLE VACUUM SYSTEMS!

### PACS 1000

PACS trailer mounted vacuum systems are available in a variety of configurations. PACS 1000 is designed for removing liquids, solids, and sludge from land or water. Costing less than vacuum trucks, the PACS is approved for highway towing. Integral hydraulics allow the PACS to run oil skimmers and pumps, as well as lift the tank to dump contents.



**ELASTEC**  
All Terrain Vac

### Oil Skimmer

**Sucking up money for  
vacuum trucks**

Our Drum Skimmers are optimal for rapid response oil cleanup. Extremely efficient and cost effective, they will give you an edge over competitors.



### DrumIt

The drum filling vacuum head with auto shut off. DrumIt quickly connects to vacuum trucks for a clean interception of debris and liquids.



**ELASTEC**  
AmericanMarine  
Innovative Environmental Products

1309 West Main, Carmi IL 62821 USA  
Tel: (618) 382-2525  
Fax: (618) 382-3610  
E-mail: [elastec@elastec.com](mailto:elastec@elastec.com)



[www.elastec.com](http://www.elastec.com)

PU10/08

**You've Seen it at the Show**  
**You've Heard of its performance**  
**See what it can do for you.**

**POWER BOOSTER**  
*Patented Technology for Pumping*

Discover how over **30 years** industry experience and proven technology will increase your vacuum truck performance. By providing limitless vertical lift and distance capability, this unit will shorten project time.

Solid engineering coupled with rugged, lightweight construction make the **Power Booster™** the ultimate pumping solution. Unsurpassed execution in highly viscous applications.

**PL Pressure  
 Lift Corp**  
**972.355.0550**

*Call for a FREE Demo DVD*



**SmithCo**  
**SIDE-DUMP TRAILERS**

**SIDE DUMP**

Call **800-779-8099**  
[www.sidedump.com](http://www.sidedump.com)

30902 C38  
 Le Mars, Iowa 51031



**CP-20 Offroad**



**SHV Series**



**DT Series**



**MHV Series**



**S Series**

*Manure, Slurry, Sludge, Green Waste, Food Residuals, Compost, SmithCo Hauls it All.*  
**Stock Pile, Spread, Stability, Selection, Service...SmithCo**

PORTABLE TOILET  
SERVICE UNITS  
SLIDE IN UNITS  
HOISTED UNITS  
ROLL OFF UNITS  
CUSTOM UNITS

[www.pikrite.com](http://www.pikrite.com)

**pikrite**

Manufacturing & Sales - 60 Pik Rite Lane - Lewisburg, PA 17837

**1-800-326-9763**

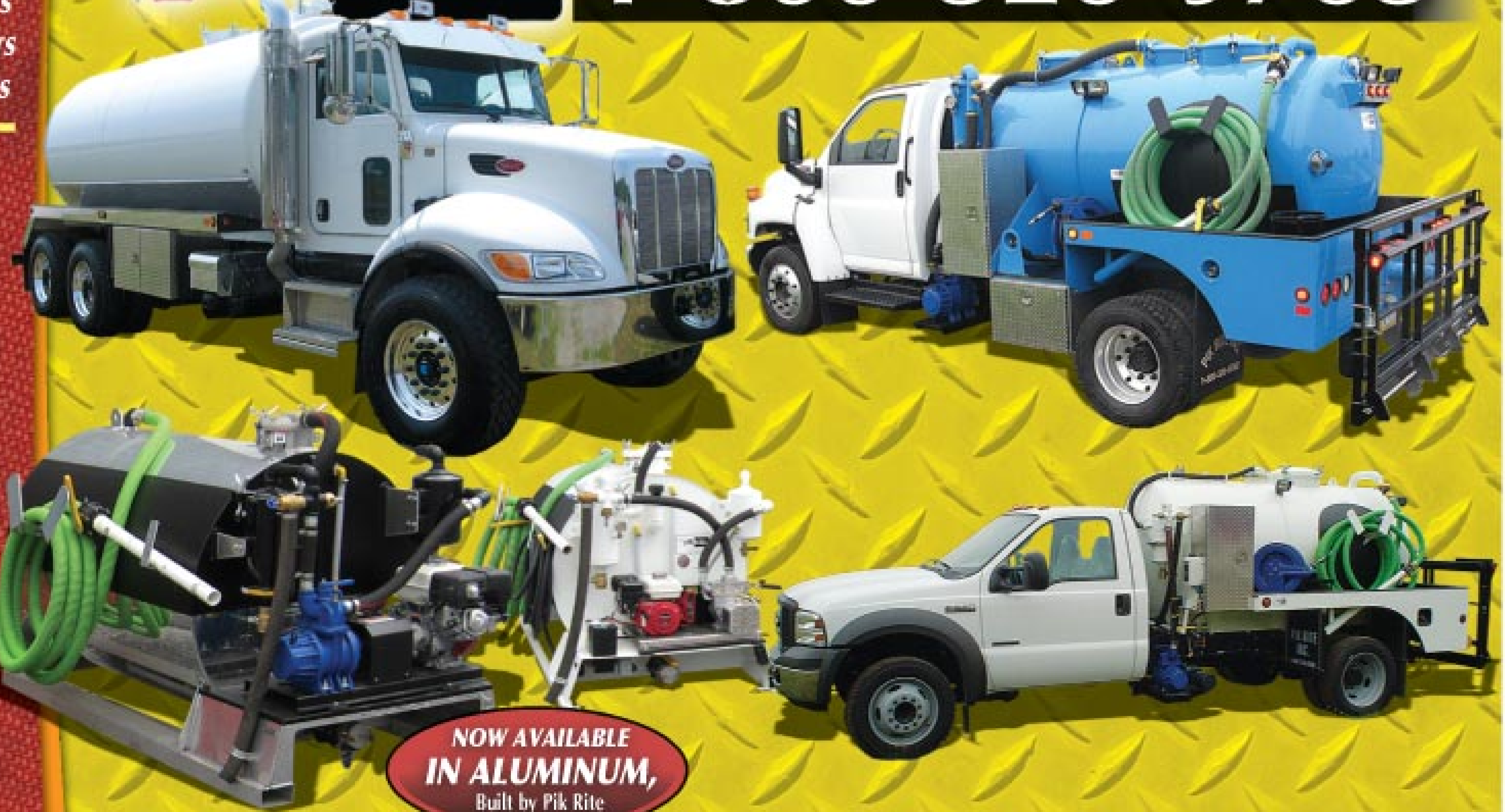

**NOW AVAILABLE  
IN ALUMINUM,  
Built by Pik Rite**

**Come In  
We're**

**OPEN 24/7**

[www.pumper.com](http://www.pumper.com)



**"Dedicated to Timely and Affordable  
Services to Ensure Complete  
Customer Satisfaction"**

**2010 Products and Services**

**Quality Workmanship - Professional Service - Competitive Prices**

**REPAIR**

**Re-Manufacture**

- ✓ Industrial Blowers
- ✓ Transfer Cases
- ✓ Vacuum Loaders
- ✓ Pump Trucks
- ✓ Water Pumps

**SALES**

**New or Exchange**

- ✓ Blowers
- ✓ Aftermarket Parts
- ✓ Used Equipment

The Power Vac name has long been associated with professional service, quality workmanship, competitive pricing, and timely performance on repairs and re-manufacturing of industrial vacuum loaders and their related components. We also want to be your #1 choice for sales of new or exchange equipment, aftermarket parts and used equipment.

As always you can rely on Power Vac to restore your equipment to peak operating performance. The following is a partial list of the fine manufacturers we service:



W228 N2792 Duplainville Road, Unit G • Waukesha, WI 53186

**P: 262.542.8989 • F: 262.542.6262**



The 5th Annual Waste Treatment Symposium is Sept. 15-16 at Hapchuk Inc., a liquid waste disposal company in Washington, Pa.



NATIONAL ASSOCIATION OF WASTEWATER TRANSPORTERS, INC.



336 Chestnut Lane  
Ambler, PA 19002  
1-800-236-NAWT (6298)  
Fax 267-200-0279  
www.nawt.org

**NAWT EXECUTIVE DIRECTOR:** A. Thomas Ferrero, Jr.

**NAWT BOARD OF DIRECTORS:**

Roger Winter, President, Ontario  
Bruce Fox, Vice President, PA  
Ralph Macchio, Treasurer, NY  
Tom Ferrero, Secretary, PA  
Tom Frank, Past President, OH

Jim Anderson, MN  
Mark Hacker, IN  
Jace Ensor, NM  
Tim Frank, OH  
Bill Hall, CT  
Wayne Hudson, DE

Tom Johnson, NY  
Bob Kendall, WI  
Frank King, MA  
Susan Ruehl, OH  
Carl Stenberg, MI

# Reorganization for Maximization

## Fifth Annual NAWT Waste Treatment Symposium restructured based on attendee comments

By Tom Ferrero

**W**e are always appreciative of members who take time to offer suggestions or constructive criticism. After assimilating the comments from last year's Waste Treatment Symposium, we acted on major concerns. For example, participants who attend multiple symposiums want more new material. Consequently, we've added advanced topics covering operational issues people experience at their facilities. We'll still cover the basics, since half or more of the attendees are first-timers with no treatment background.

Attendees also wanted to spend more time at the field site, and have presentations coordinate with the live equipment demonstrations. They said that seeing the demos first raised a lot of questions they wanted answered back in the classroom.

NAWT's issue was attendance. We were expecting 150 in Orlando and 100 came. The venue or the economy or both could explain this. So, the 5th Annual Waste Treatment Symposium will be held on Sept. 15-16 at Hapchuk Inc., a liquid waste disposal company in Washington, Pa. The six truck shops are so clean you could eat off the floor. In fact, owner Dave Hapchuk hosted a wedding rehearsal dinner for 250 people in his

garage. We'll serve lunch there both days and dinner Wednesday night. We're still working on lodging, but it will be about three miles away. Plan to fly into Pittsburgh, then rent a car for the 30-minute drive to Hapchuk's business.

Thursday morning, coaches will transport attendees to Hapchuk's treatment facility, Liquid Assets Disposal, in Wheeling, W. Va. The afternoon classroom sessions include a question-and-answer forum with all the speakers and vendors on stage.

Ample networking time is part of the symposium

**"BESIDES THE PRESENTERS, THE ADVANCED OPERATORS ARE A WEALTH OF KNOWLEDGE. THEY DEVELOP CREATIVE ECONOMICAL, INNOVATIVE SOLUTIONS TO OPERATIONAL PROBLEMS USING THE BAILING WIRE AND BUBBLE GUM APPROACH."**

experience. Besides the presenters, the advanced operators are a wealth of knowledge. They develop creative economical, innovative solutions to operational problems using the bailing wire and bubble gum approach.

Lastly, many attendees thanked us for opening their eyes to the 2009 Water Environment Federation Technical Exhibition and Conference, or WEFTEC. This year, it's on Oct. 2-6 at the Ernest N. Morial Convention Center in New Orleans, La.

### 2010 SYMPOSIUM AGENDA

**WEDNESDAY (classroom all day)**

Welcome and introduction, Tom Frank, Tim Frank  
Septic Tank Cleaning Co., Huntsburg, Ohio

Analyzing Your Resources, Regulations, Permitting,  
Hiring an Engineer

Unit Processes – speakers to be determined

- Screening
- Grit removal
- Dewatering options
- Equalization and storage
- Chemical additives

Pump Applications

**Case History of Liquid Assets Disposal**, Dave Hapchuk, owner, Washington, Pa.

**Social hour** for networking with hors d'oeuvres, cash bar and dinner.

**THURSDAY (morning field trip, afternoon classes)**

**Field Trip**, Liquid Assets Disposal, Wheeling, W. Va. Coaches return to Hapchuk Inc. for lunch.

**Class A Biosolids Options**, Robert Rubin, Ph.D., consultant with McKim & Creed, Cary, N.C.

**Odor Control Techniques**

**Sewer Surcharge Reduction Techniques**, Bob Advent, Advanced Industrial Aeration, Orlando, Fla.

**Grease Treatment Technologies**

**Q & A Forum**

**COST:**

The registration fee for NAWT's symposium is \$275 for members and \$375 for nonmembers. Download the registration form at [www.nawt.org](http://www.nawt.org). Registrations must be received by Sept. 1. Don't miss this one.

**Something smells**

The Internet is a marvelous tool, but also the

source of much erroneous information. Homeowners seeking ammunition to rebut inspector reports can find an arsenal on the Web. One site claims the industry is fueled by the billions of dollars it makes pushing an agenda to replace failed conventional systems with expensive alternative technologies. The inexpensive repair we supposedly keep secret is aerobic treatment devices.

While the premise is wrong — we are not hiding anything — it makes a valid point. Too many in our industry are unaware of all the available technologies and can't offer less expensive alternatives, such as inoculator generators or soil fracturing, when applicable. The reality eluding the Web site owner is that one size does not fit all. Every household is different, from their diets and the way they cook to the products used.

The Web site owner also is unaware that not all state regulators recognize all the available repair tools. That level of ignorance is bad enough state by state, but it's terrible county by county, where many regulators won't even consider options

because their heads are buried in the sand.

Service providers can't always tell if adding bags of proprietary microbes or fluffing the soil is the correct solution, but we should be allowed to offer the possibility to customers on a contractual agreement. If the equipment doesn't work, buy it back and sell it where it will. Homeowners will accept the risk when they're looking at \$5,000 instead of \$25,000. Service providers don't use contractual agreements enough, and I believe it is becoming a significant oversight in today's evaporating economy. You can't take money from every job and keep going forward without looking back. It's unethical. ■

**Summit Array™ of Software Products**  
• Over 28 years experience • Easy to use • Affordable • Powerful

**Not ready for a full software solution?**  
Start with our **Reminders Plus™** program  
- Reminder Cards, Repeat Business & Marketing Tools -

**\$97 THROUGH APRIL ONLY (Reg. \$136.99)**  
Data is fully upgradeable to our robust Summit Service Profit Builder™  
Act now, and the price is fully credited if you upgrade within 1 year!

**WATCH DEMOS ON LINE!...or call for a personal guided tour**  
**FREE STUFF! \$267 value ...only pay \$/H.**

 **Ritam Technologies, LP**  
Sales: USA 800-662-8471 • Int'l: 208-629-4462  
Email: [info@ritam.com](mailto:info@ritam.com) • Web: [www.ritam.com](http://www.ritam.com)



## Tanks For Your Business

Mid-State Tank manufactures stainless steel and aluminum tanks and has become a well-known and respected supplier for the agricultural, aviation, industrial and fire services, as well as pressure/vacuum tanks.

Mid-State Tank holds an ASME stamp and is D.O.T. approved.



### Mid-State Tank Co., Inc.

PO Box 317 • Sullivan, IL 61951  
(800) 722-8384 • Fax: (217) 728-8384  
[www.midstatetank.com](http://www.midstatetank.com)



## "DON'T BE EMBARRASSED AGAIN!" HOW AWFUL...

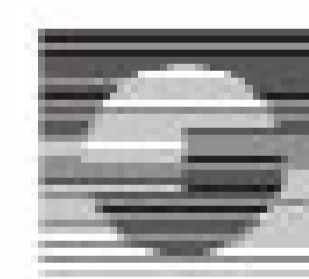
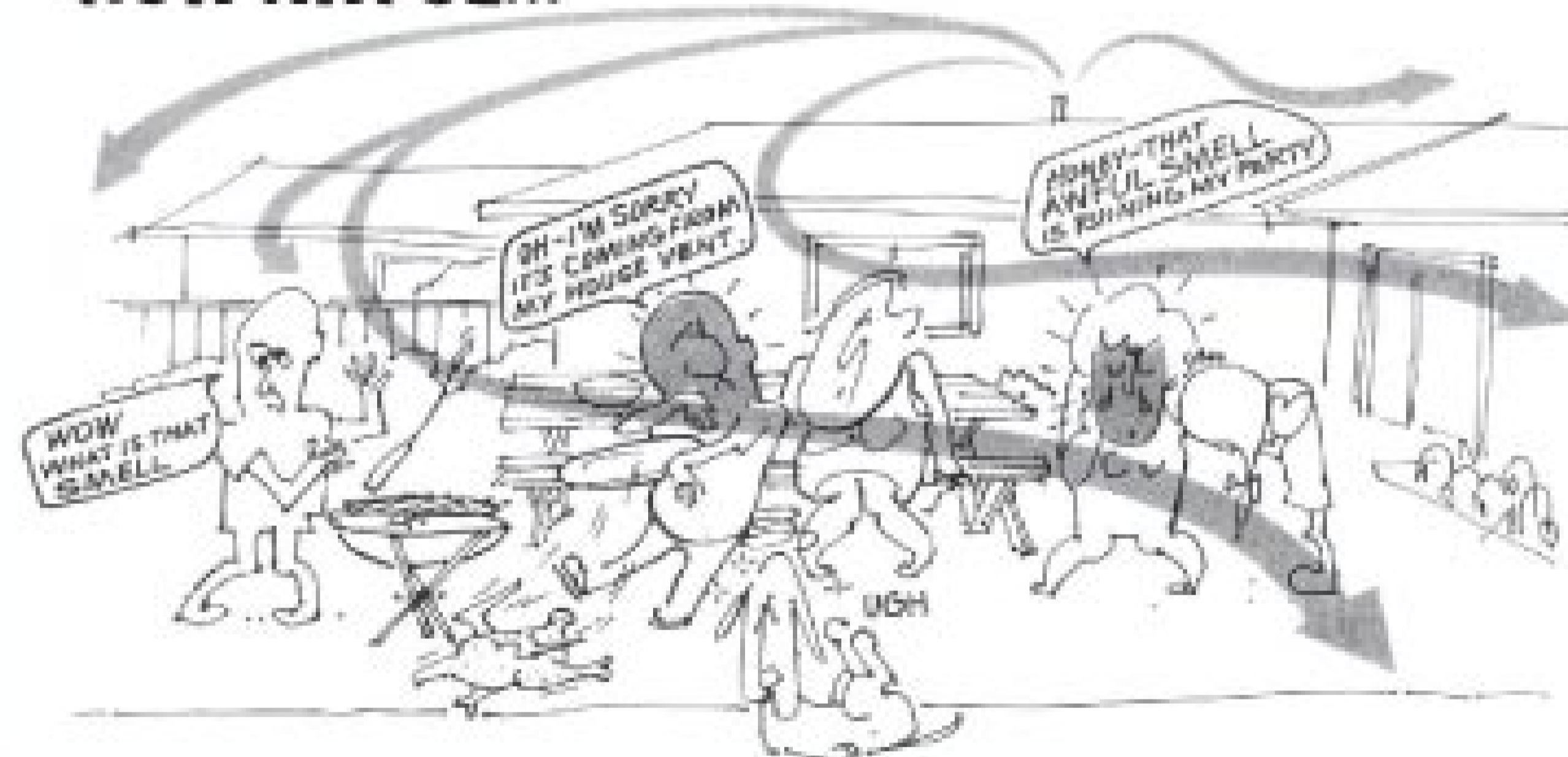

**800-622-8768**  
[sweetair.com](http://sweetair.com)

**SWEET SEPTIC SYSTEMS, INC.**  
5701 Mother Lode Drive • Placerville, CA 95667  
Fax: 530-622-1087

## SWEET AIR™ FILTERING DEVICE

PAT PENDING

### HOW WONDERFUL...

UPC Approved

*Sweet Air*





**Locators**  
512 Hz  
Only  
**\$795**

Plus  
Leak Detectors  
Split Box Locators  
Transmitters

**Cameras**

As Low As  
**\$399**

36 Models To  
Choose From



Video  
Online

**Conversion  
Kits**  
**\$299**

Convert A  
Pressure  
Washer  
To A Jetter



No Compromise  
Best Service/Best Price

**AMAZING  
MACHINERY**

Your Equipment SUPERSTORE Since 1995

Celebrating 15 years

**1-800-504-7435**

Complete Details At  
[www.AmazingMachinery.com](http://www.AmazingMachinery.com)

**Jetters**



Starting At

**\$8695**

Up To 4000 psi  
& 22 gpm

Starting At

**\$1499**

Up to 4000 psi  
& 12 gpm



- Line Bursting Systems
- Manhole Cleaners
- Grease Trap Pumps
- Hot Water Jetters
- Hydrostatic Line Testers

**Cable Machines**



**\$419**

1/3 hp

**\$1499**

3/4 hp



**Jetter Nozzles**

From  
**\$16.95**

Custom Drilled 2-25 Orifices



**Generators / Air Compressors / Pressure Washers / Trash Pumps**

**BUSINESSES FOR SALE**

**Texas Septic and Sewer Business.** Grossing in excess of \$1,000,000 annually. Includes 2007 2500 gallon septic truck, 1995 2500 gallon septic truck, 2007 and 2008 Chevy service trucks, portable restrooms and more. 430 contracted customers. **\$799,000.**

**North Carolina Septic Business.** Grossing in excess of \$125,000 annually. Includes 2,000 gallon service truck, backhoe, jettors and more. **\$110,000.**

**Northern California/Reno, Nevada Area Portable Restroom Service Business For Sale.** Averaging \$115,000 in revenue over past 4 years. Includes two service trucks, 100 restrooms, trailers and more. **\$75,000 REDUCED \$55,000** - motivated seller.

**Dallas/Fort Worth Texas Area Sewer/Rehab Business For Sale.** Drain Cleaning, TV inspection, Pipeline & Manhole Rehab/Relining, Municipal Cleaning and Maintenance business for sale. Excellent opportunity to expand or start your own business. Good revenue history and priced to sell. Includes all equipment to get started. **Offered at \$150,000.**

**Allentown, Pennsylvania Area Sewer Business.** Specializing in collection systems, video inspection, jetting, municipal work. Includes CUES TV & grout truck, Sewer Equipment Corporation jetter truck, Vector 2100, RIDGID camera, confined space equipment and more! Good revenue history. Great opportunity to expand or start your own business. Current owner wants to retire. **\$330,000.**

**Canton, Ohio Area Septic & Drain Business.** Septic, drain cleaning, inspection, and portable restroom business for sale. Great revenue history and priced right. Excellent opportunity to expand or start your own business. Includes all service trucks, nearly 100 restrooms, holding tanks, drain & sewer equipment, all office equipment and computers, customer list, and more - a true turn-key or easy expansion opportunity. Current owner is moving into a new profession. **Offered at \$165,000 for a quick sale.**

**Houston, Texas Area Septic & Drain Business.** Grossing nearly \$300,000 annually and showing growth. Established commercial clients and customer list. Includes all equipment to operate, a turn-key business. Huge potential, owner is motivated and moving on. **Asking \$140,000.**

**Massachusetts Sewer & Drain Franchise For Sale.** Confidential listing, Non Disclosure Agreement required. Turn-key business, good revenue. **Asking \$165,000.**

Go to [www.btwo.biz](http://www.btwo.biz),

e-mail [jeffb@colepublishing.com](mailto:jeffb@colepublishing.com) or

call **800-257-7222**

and ask for Jeff Bruss for more details.



**Special Thanks!**



Thank you... Phil & Michelle Anderson  
Mr Rooter Plumbing, Hartsville, SC  
Driving home from the Pumper Show in 'Style'.

**4200 Gallon Septic Tank**  
Wittig RFL100, air cooled, 400 plus C.F.M.  
**2009 Freightliner M2**  
Auto transmission, 330 HP Mercedes,  
18,000 lb. front / 40,000lb rear,  
exhaust brake, differential lock.  
**\$116,225** Plus F.E.T.  
Add \$5,500 for pusher axle installed.

**1700 Gallon Stainless Restroom Tank**  
Masport HXL4 standard pumping system.  
Dual service, stainless water pump,  
Hannay reel.  
**2010 International M7**  
**Special Paint!**  
Aluminum wheels,  
chrome bumper.  
**\$88,500**



**2000 Gallon Restroom Tank**  
3 Compartment 250/250/1500  
Standard pumping system.  
Dual service, Hannay reel.  
**2010 International M7 Special Paint!**  
Aluminum wheels  
chrome bumper.  
**\$88,275**



**Slide-In Skids...  
Call To Get Our Low Price!**

Custom built to your specs!

[www.keevac.com](http://www.keevac.com)  
**KeeVac**  
Industries Inc.  
**866-789-9440**

**'Old Emission' chassis... BUY NOW! ... SAVE BIG!**  
Large selection of 'old emission' chassis still available.  
International - Freightliner - Kenworth - Hino - Ford  
FINANCING DELIVERY CUSTOM BUILDS

**It's A Bag Full**

[pumper.com](http://pumper.com)

- > Classifieds
- > Truck Stop Ads
- > E-zines
- > Product Categories

**THE LEADER IN PUMPER/CLEANER REELS SINCE 1933**

**Hannay Reels**  
The reel leader.

**Washdown and Clean Up With Hannay Reels**

**Applications**

- Power washing
- High pressure washing
- Vehicle and equipment washdown and clean up

**Advantages**

- Flexibility of mounted and portable designs
- Hose pickup and storage is quick and neat
- Tried and tested technology
- Tough reels for the toughest environments

Download or call for your FREE catalog  
<http://go.hannay.com/515> **877-467-3357**

**APRIL SPECIAL**

**Portable Restroom Trailers**

**13" Tires**  
**23" High**

8 Restroom . . .	\$4000
10 Restroom . . .	\$4500
14 Restroom . . .	\$5300
16 Restroom . . .	\$5700
20 Restroom . . .	\$6500

**Steel Tanks**

Polished Aluminum Skirting and Tool Boxes

- 2009 Dodge 5500, Cummins Diesel, Automatic, 19,500 GVW, 1000 Waste, 300 Fresh ... **New 4x2 \$62,500**  
..... **New 4x4 \$65,500**
- 2008 Ford 550, 55,000 Miles ..... **\$47,000**
- 2001 International, New 2300 Gallon Tank ... **\$37,500**

**Aluminum Tanks**

by Amthor 5/16" Thick

- 2009 Dodge 5500, Cummins Diesel, Automatic, 19,500 GVW, 1000 Waste, 400 Fresh  
..... **New 4x2 \$71,500**  
..... **New 4x4 \$74,500**

- All Brand Trucks Available
- New Septic Trucks Available
- Used Septic and Toilet Trucks Available

**Trailer Mount Slide-in Tank**  
600 gallons waste/200 gallons fresh water.  
**\$13,500**

**SLIDE-IN UNITS & USED TRUCKS AVAILABLE / MASPORT, JUROP & CONDE VACUUM PUMPS**  
**CHECK OUR PRICES**

**LANE'S VACUUM TANK, INC.**  
3133 VANZORA RD. • BENTON, KY 42025  
**800.592.3308 • 270.527.9945**  
RODNEY LANE'S CELL **270.832.3793**

**We stand behind our trucks and trailers!**

By **Scottie Dayton**

## **OREGON: Working On a Mystery**

In response to "Mystery in Oregon" in November's Association News, installers e-mailed Kim Aldrich, a Yamhill County regulator, about their experiences with decaying concrete components in onsite systems. She published correspondence from Wisconsin, Indiana and Washington in a newsletter.

Two of three e-mails reported water softeners plumbed to the septic tank. Last November, presenters at a water softener task force meeting in Virginia revealed that sodium in water-softening salt can increase the production of sulfides and hydrogen sulfide. The compounds and gas react with oxygen to form sulphuric acid, which erodes concrete in the upper reaches of tanks and distribution boxes. (No definitive conclusion can be drawn in these cases that water-softening systems were the cause of deterioration.)

## **CONNECTICUT: Questionable Change**

The Connecticut On-Site Wastewater Recycling Association opposed an attempt by the state Department of Public Health to consolidate many small, full-time health departments into several large health districts and fund only departments in cities with populations larger than 50,000 and districts with three or more towns.

In a letter to the governor, COWRA president Frank Talarico stated that eliminating local health offices increased contractors' travel time to satellite district offices, and for department staff to do inspections.

Talarico said COWRA would support programs to improve the qualifications of local health directors and sanitarians, and asked for support to identify qualified local regulators to help maintain their positions.

In a second letter to the governor, the organization objected to the state requiring individuals maintaining small advanced treatment systems to be certified Class 1 Wastewater Treatment Operators. The group argued that operating smaller systems requires different skills and experience than operating municipal treatment plants.

The letter suggested following the training and licensure program developed by the University of Rhode Island for smaller advanced treatment systems, and requested a meeting to share insight about smaller systems.

## **ALBERTA, CANADA: Human Waste Goes Green**

Anne Naeth, a land reclamation expert at the University of Alberta, has studied combining biosolids with lime-kiln dust, a byproduct of lime manufacturing. Tests show the mix kills pathogens such as *E. coli*, binds water-soluble metals and produces a beneficial organic soil.

The most promising use for the material is for filling in quarries and abandoned oil and gas wells. She also hopes the product might eventually be used as a farm fertilizer.

## **Alabama**

Licensing classes are the joint effort of the Alabama Onsite Wastewater Association and University of West Alabama. Courses are at UWA Livingston campus unless stated otherwise:

- May 5-7 – Basic Installer
- May 19-21 – Advanced Installer Level II
- June 24-25 – Continuing Education, Dothan
- July 8-9 – Pumper
- July 28-30 – Basic Installer

The first day of Continuing Education classes is for installers and the second day for pumpers and portable restroom operators. Call 334/396-3434 or visit [www.aowa.org](http://www.aowa.org).

## **California**

The California Onsite Wastewater Association is offering a Science of Soils class on May 21 at Yuba City. Call 530/321-2207 or visit [www.cowa.org](http://www.cowa.org).

## **Iowa**

The Iowa Onsite Wastewater Association is offering Pumping and Maintenance of Conventional Systems on May 17 at a location to be determined. E-mail Alice Vinsand at [execdir@iowwa.com](mailto:execdir@iowwa.com) or visit [www.iowwa.com](http://www.iowwa.com).

## **Kentucky**

The Kentucky Onsite Wastewater Association has a Certified Installers of Onsite Wastewater Disposal Systems class for six CEUs on May 20 at the Bluegrass Community Technical College in Lawrenceburg. Call 270/314-7110 or visit [www.kentuckyonsite.org](http://www.kentuckyonsite.org).

## **Minnesota**

The University of Minnesota Extension has these classes:

- May 3-4 – Maintaining Onsite Systems, Mankato
- May 4-7 – Service Provider, Mankato
- May 18-21 – Advanced Design and Inspection of Onsite Systems, Part 2, Mankato
- May 24-26 – Basic Design of Onsite Systems, White Bear Lake
- May 27-28 – Soils, Austin
- June 7-8 – Inspecting Onsite Systems, Waseca
- June 9-10 – Soils, Brainerd
- June 11 – Soils Continuing Education, Brainerd
- June 18 – Soils Continuing Education, Rochester
- June 24 – Soils Continuing Education, Willmar

Call Nick Haig at 800/322-8642 (612/625-9797) or visit <http://septic.umn.edu>.

## **Missouri**

The Missouri Smallflows Organization is offering these CEU courses:

- May 11 – Drip Irrigation: Design and Installation, Chillicothe
- May 12 – Pumps, Panels, and Electrical, Chillicothe
- May 25-26 – High-Strength Waste and Aerated Treatment Units, Liberty
- June 15-16 – Operation and Maintenance, Jefferson City

Call Tammy Yelden at 417/739-4100 or visit [www.mosmallflows.org](http://www.mosmallflows.org).



# Calendar

## April 9-10

Oregon Onsite Wastewater Association Conference and Equipment Rodeo, Red Lion Hotel Jantzen Beach, Portland. Call 541/389-6692 or visit [www.o2wa.org](http://www.o2wa.org).

## April 11-14

Ontario Onsite Wastewater Association Conference and Exhibition, London Convention Centre/Hilton Hotel. Call Denis Orendt at 905/372-2722 or visit [www.oowa.org](http://www.oowa.org).

## April 12-15

BioCycle West Coast Conference, Town and Country Resort, San Diego. Call 610/967-4135 or visit [www.biocycle.net](http://www.biocycle.net).

## June 6-9

National Onsite Wastewater Association Educational Conference and Exhibition, Albuquerque, N.M. Call 866/956-2258 or visit [www.neha.org](http://www.neha.org).

## Aug. 5-7

Florida Onsite Wastewater Association Conference and Trade Show, Daytona Beach Convention Center, Daytona Beach. Call 407/937-2228 or visit [www.fowaonsite.com](http://www.fowaonsite.com).

## Aug. 27-28

Georgia Onsite Wastewater Association Conference, Callaway Gardens, Pine Mountain. Call 678/646-0379 or visit [www.onsitewastewater.org](http://www.onsitewastewater.org).

## New England

The New England Onsite Wastewater Training Center at the University of Rhode Island in Kingston has these workshops:

- May 5 – Functional Inspections
- May 11 – Innovative and Alternative Technology Overview
- May 20 – All About Series: Sand Media
- May 27 – Innovative and Alternative Technology Field Overview, URI Peckham Farm
- June 1-2 – National Operation and Maintenance Service Provider Program
- June 15 – INSP200 Examination
- June 16 – Soil Basics for the Onsite Wastewater Contractor
- June 17 – Hands-On Component Installation
- June 24 – Bottomless Sand Filter Design and Installation

Call 401/874-5950 or visit [www.uri.edu/ce/wq](http://www.uri.edu/ce/wq). For soil course information, call Mark Stolt at 401/874-2915 or e-mail [mstolt@uri.edu](mailto:mstolt@uri.edu).

## North Carolina

The North Carolina Portable Toilet Group is offering a Septage Operator Training seminar on June 19 in New Bern. Call 252/249-1097 or visit [www.ncpumpergroup.org](http://www.ncpumpergroup.org).

## Washington

The Washington On-Site Sewage Association and Washington State Department of Health in cooperation with Washington State University are offering these certification courses.

- May 5 – Electrical Control Panels, Puyallup
  - May 6 – Installing Mounds and Sand Filters, Puyallup
  - May 13 – Design Siting, Centralia, Puyallup
  - May 19 – Evaluating and Repairing Onsite Systems, Bremerton
- Call WOSSA at 253/770-6594 or visit [www.wossa.org](http://www.wossa.org).

## Wisconsin

The Wisconsin Onsite Wastewater Recycling Association is holding a Private Onsite Wastewater Treatment System Evaluator Course on May 3-4 in Waukesha. Call 608/256-7757 or visit [www.wowra.com](http://www.wowra.com). ■

**Nobody Beats Our Quality!**



# DENVER TRUCK SALES



**Tanks Manufactured In House**

**3-2006-2007 Mack Granite Models**  
18,000-20,000 FA, 427-460 HP, Mack engines, Jakes, T-313-318 L transmissions, 44-46,000 lbs. rears, 3360 gallon tanks and pumps, very low mileage.  
**From \$79,500 (n.a.p.)**



**500-4200 Gallon**  
Single or 2 compartment vacuum tanks with pumps, tank options mounted on your truck or ours.  
**Call for special prices. (n.a.p.)**



**Complete Lines of Pumps and Parts**

**2004-2006 International 9400**  
C-12-15 Cats, Jakes, 355-475 HP, RTLO-18713 transmissions, RT-40145 Rears on Hendrickson air suspension, 1122.5 tires, new 3360 Gallon tank, 400 CFM pumps, new paint, serviced and checked.  
**From \$57,950 (n.a.p.)**



**1999-2001 Western Star 4964 EX**  
C-15 Cats, Jakes, 475 HP, RT-18913 transmissions, RT-40145 Rears on Hendrickson air suspension, 1124.5 tires, dual stainless steel air cleaners, dual stacks, diamond tufted upholstery, new 3360 gallon tanks, new 400 CFM pumps, serviced and checked.  
**From \$54,950 (n.a.p.)**

**Easy Financing and Lease-To-Own WAC!**

**Denver Truck Sales • 5293 Vasquez Blvd. • Denver, CO 80216**  
Phone: 303-291-0960 • Fax: 303-291-0244 • [www.denvertruck.com](http://www.denvertruck.com)



A Subsidiary of The Gorman-Rupp Company™

## 12 VOLT DC HIGH HEAD WASHDOWN PUMP

- 1 HP Washdown Duty Motor for Severe Operating Conditions
- Investment Cast 316 Stainless Steel, Cast Iron or Cast Bronze Construction
- All Models Equipped With High Efficiency Stainless Steel Impeller
- Discharge Port Rotates in 90° Increments
- Four Front Drain Plugs
- Maximum Flow 56 GPM
- Maximum Head 80 Ft. (35 PSI)
- Maximum Temperature 200° F



The AMT 12 Volt DC Washdown Pumps are designed for pumper, septic service, OEM, and marine applications requiring a DC motor. The motor has a one hour duty rating and is furnished with a grade 303 stainless steel shaft. Washdown Duty Pumps are available in a variety of construction and seal materials to meet your specifications. Pull-from-the-rear design for easy servicing without disturbing piping.

**Call us toll free at 888-268-7867 or visit our website [www.amtpump.com](http://www.amtpump.com) for more information.**

American Machine & Tool  
A Subsidiary of The Gorman-Rupp Company  
400 Spring Street  
Royersford, PA 19468



# Wee Engineer

WITH IMAGINATION

## Call us for a quote...

# WE

...are in it for the long HAUL.

### Best Heavy-Duty Portable Toilet Trailers on the Market



24ft....\$8,400  
28ft....\$8,700  
34ft....\$9,678

Our customers are pleased with the time they save loading and unloading toilets from our uniquely designed tie-down system.

### Call us about this tank.

We will find a good used truck or put it on a truck of your choice. New 2500 gallon, carbon



steel vacuum tank 3" inlet, 4" outlet, rear work lights, 20" top primary, 20" Rear manway, 5-gallon secondary. Price includes lights and valves.  
Price: .....\$12,750



**Wee Vac** The Wee Vac fits through a standard doorway and can pump up to 40 gallons of grease at a time. It has a female cam-lock so it can be downloaded into your truck. It features a 110 volt vacuum pump. **Price: \$1,240**



**2003 Freightliner FL-70**, Allison automatic, air brakes, 265,000 miles. New carbon steel tank 2500-gallon and New Battioni vacuum pump, MEC 8000. Price: ...\$37,500



### Heated Collars

Preventing your valves from freezing will help your profits during the winter months.

Installation kit and 110 volt heater kit available

1.5-2" .....\$110  
3" .....\$165  
4" .....\$198  
6" .....\$297

Grandpa Smith's pump truck of the 1930's

P.O. Box 39 Dayton, IN 47941 Toll-Free: **877-296-2555** Phone: **765-296-2027** Fax: **765-296-3027**

[www.wee-engineer.com](http://www.wee-engineer.com)

*Introducing the Most Durable and Economical Septic Lid in the Market Today.*

Cost Effective  
**6 Pack**  
Shipping

Now Offering  
**18" & 24"**  
**Custom Lids!**

- Durable Roto-Molded Construction **WILL NOT Crack Like Concrete!**
- Lightweight Polymer is Easier to Handle & Transport
- Corrosion Resistant Stainless Steel Screws Included
- For use with Standard 12", 18" and 24" I.D. Corrugated Pipe
- Easy Slide-in Installation
- Optional Sand Filled

**Roto Solutions**

# 800.868.0973

Don't Waste Money On Expensive Riser Systems!

EQUIPMENT FINANCE

TCF Equipment Finance  
Enjoyed Seeing You At The  
Pumper & Cleaner Expo!

### Why TCF Equipment Finance? Ask our customers ...

Committed to our relationships  
Outstanding pricing, service & products  
Bank owned direct lender with backing of over \$18 Billion in assets  
Equipment leasing and finance available in all 50 states  
Financing solutions for all your equipment acquisition needs

Waste Industry Expertise  
Direct Lender  
Loan & Lease Structures  
Highly Competitive Bank Rates  
Fast Credit Decisions

100% Financing  
New & Used Equipment  
App-Only Financing Programs  
Significant Tax Advantages  
Flexible Payment Options

#### Contact:

**David Penoff or Wendy Wilson**  
Environmental Services  
877.878.1161 Toll-Free  
[www.tcfef.com](http://www.tcfef.com)

**TCF**  
EQUIPMENT FINANCE

EXPERTS AT DELIVERING EQUIPMENT FINANCE SOLUTIONS

TCF Equipment Finance, Inc. is a wholly owned subsidiary of TCF National Bank (TCF).  
TCF is a subsidiary of TCF Financial Corporation (NYSE:TCF).

# Pumper Marketplace Advertising

## Pumper Marketplace

gives you **nationwide** exposure  
to **thousands** of industry professionals.

Layout and design is included **FREE**, and we can fax or e-mail you a proof for final approval!



**Now Available In 4-Color**

Choose a size that works best for you! Call **1.800.994.7990**

\*Black and white prices, call for 4-color pricing.

Send ad materials and payment to:

**COLE PUBLISHING INC. • P.O. BOX 220 • THREE LAKES, WI 54562**

# Marketplace Advertising

IndustrialOdorControl.com

866-NO-STINK (667-8465)  
973-846-7817

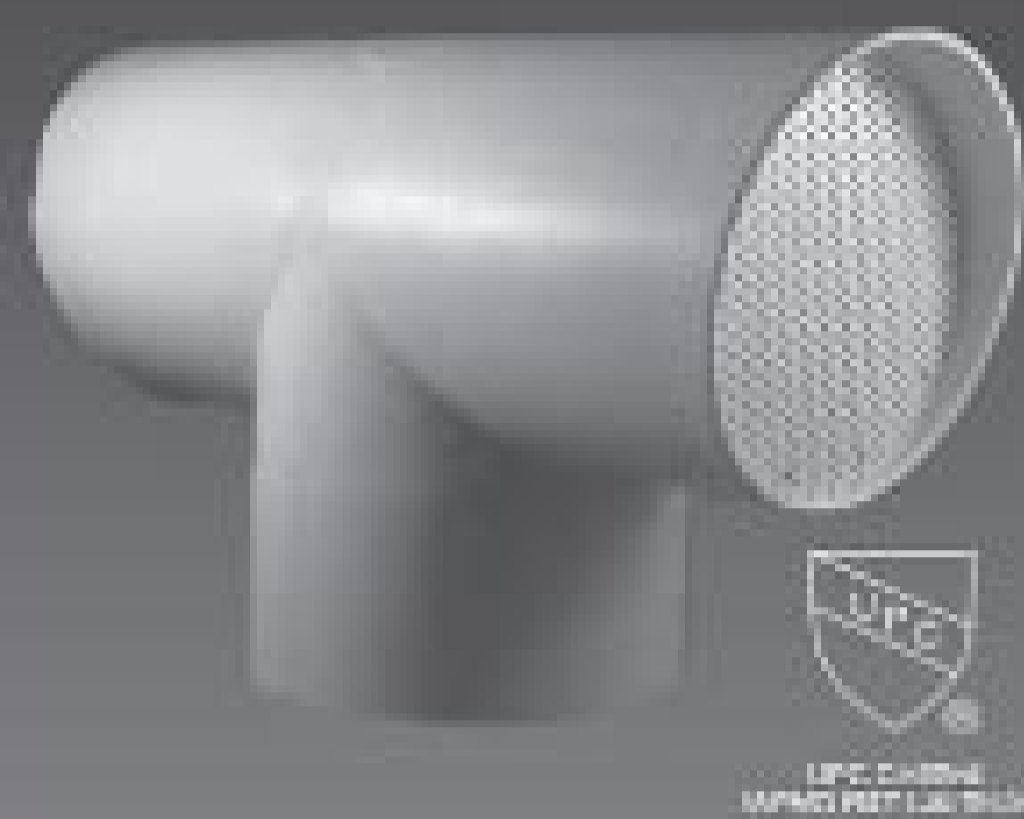

For a limited time  
Buy a WLV-4  
septic vent filter  
and get a  
year's supply of  
microorganism  
septic additive for  
**FREE\***

\*Limit one per order (6 per case)



Simple Solutions  
DISTRIBUTION, LLC



## EASILY MOVE RESTROOMS

- ✓ Aluminum Frame
- ✓ Ships UPS
- ✓ Carry ADA's
- ✓ Models starting at \$380



Available with 2, 4, 6 or even 8 wheels and your choice of air or solid foam tires.

**Super Mongo Mover®**

**DA**  
Deal Assoc. Inc.

www.dealassoc.com

866.599.3325

# DECALS

LOW COST  
HIGH  
QUALITY  
FAST  
TURNAROUND

- Portable Toilet High Tack Decals
- Service Records
- Fleet Graphics
- Equipment Decals
- Lack of Service Tags

SERVING YOU  
SINCE 1954

CALL US TODAY!  
800.829-3021

**ScreenTech**  
IMAGING

a division of Roeda Signs, Inc.

email: debbie@screeentech.com

www.screeentech.com

# DISCOUNT ALUMINUM

**SHEET,  
COIL,  
PLATE**

3003/5052/  
5454/5083/5086  
AND MORE

20 MILLION  
POUND INVENTORY

ARE YOU PAYING  
TOO MUCH?

1-888-540-0066

ASK FOR DAN

FAX:  
440-286-2229

E-MAIL:  
captaluminum@msn.com

**T&T Tools, Inc.**  
800.521.6893

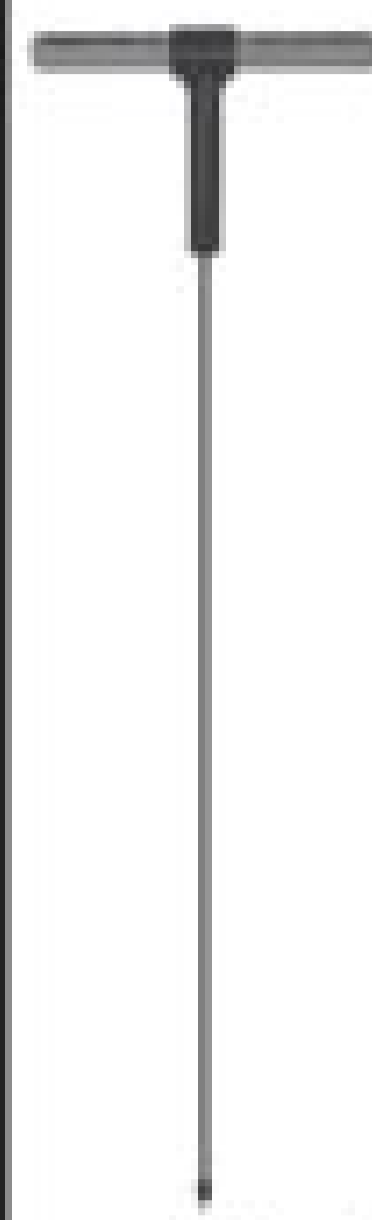

Insulated  
Soil Probes  
(for locating)



Heat-Treated  
Hooks  
(for covers, lids, etc)

CALL  
for a  
**FREE**  
Catalog

Many styles  
Available

www.mightyprobe.com

## ONE SUPPLIER

**WATER  
CANNON**

A WATER CANNON PRODUCT

1-800-333-WASH

Parts for Most Major Brands

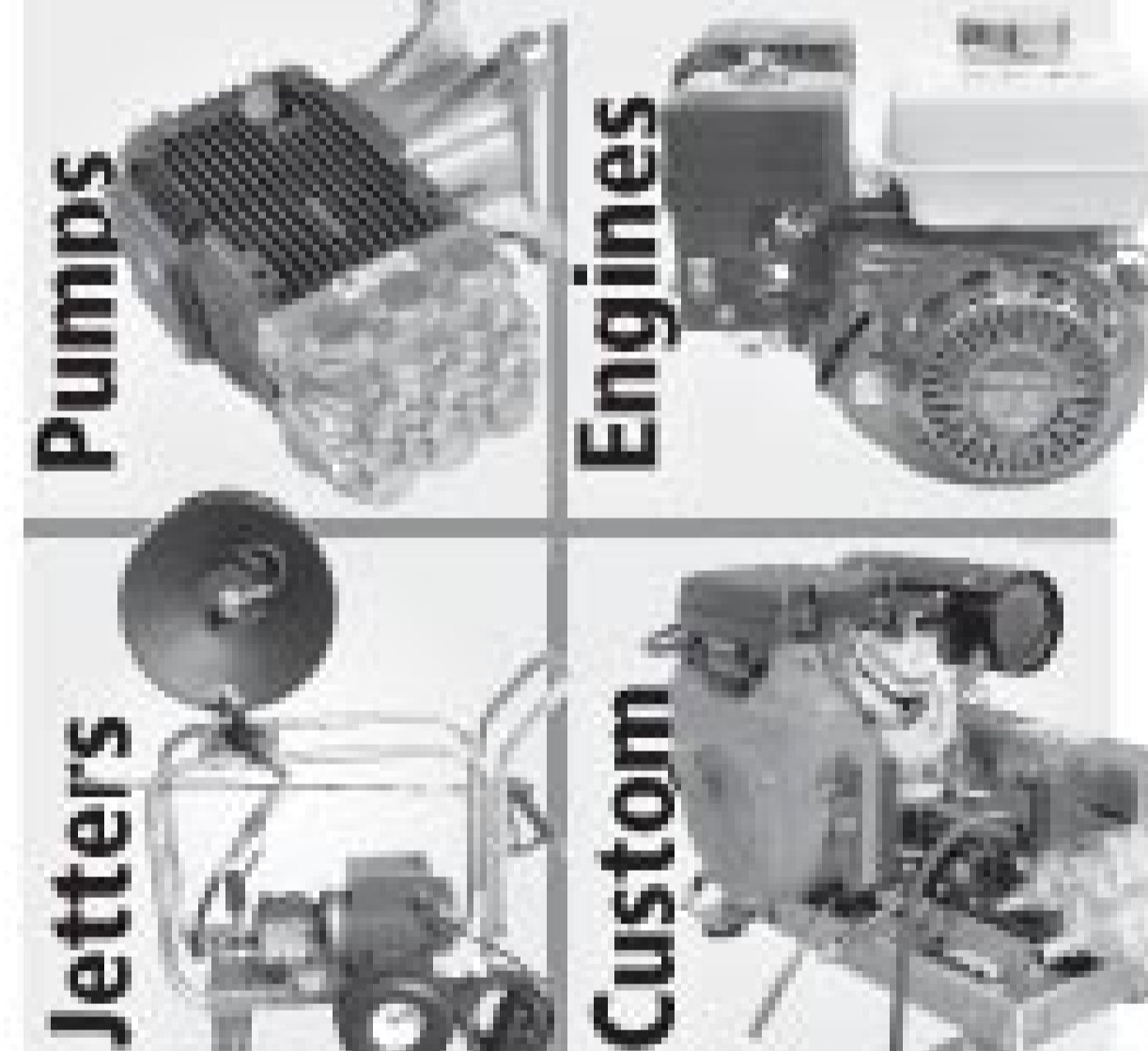

10,000 + Items Online  
www.1800333WASH.com

## THE SHADDIX COMPANY



FOB Cullman, Alabama

5-1000 gal.  
Rebuilt Septic  
Tank forms  
\$7,000 Ea

2001 FL 70  
Freightliner  
Low mileage  
with new all  
hydraulic set  
bed \$37,500



FOB Cullman, Alabama

Will build forms to your specifications.  
We build hydraulic set beds.

256-338-4987 or  
256-737-0051

# BÖRGER®

Customized  
Rotary Lobe Pumps

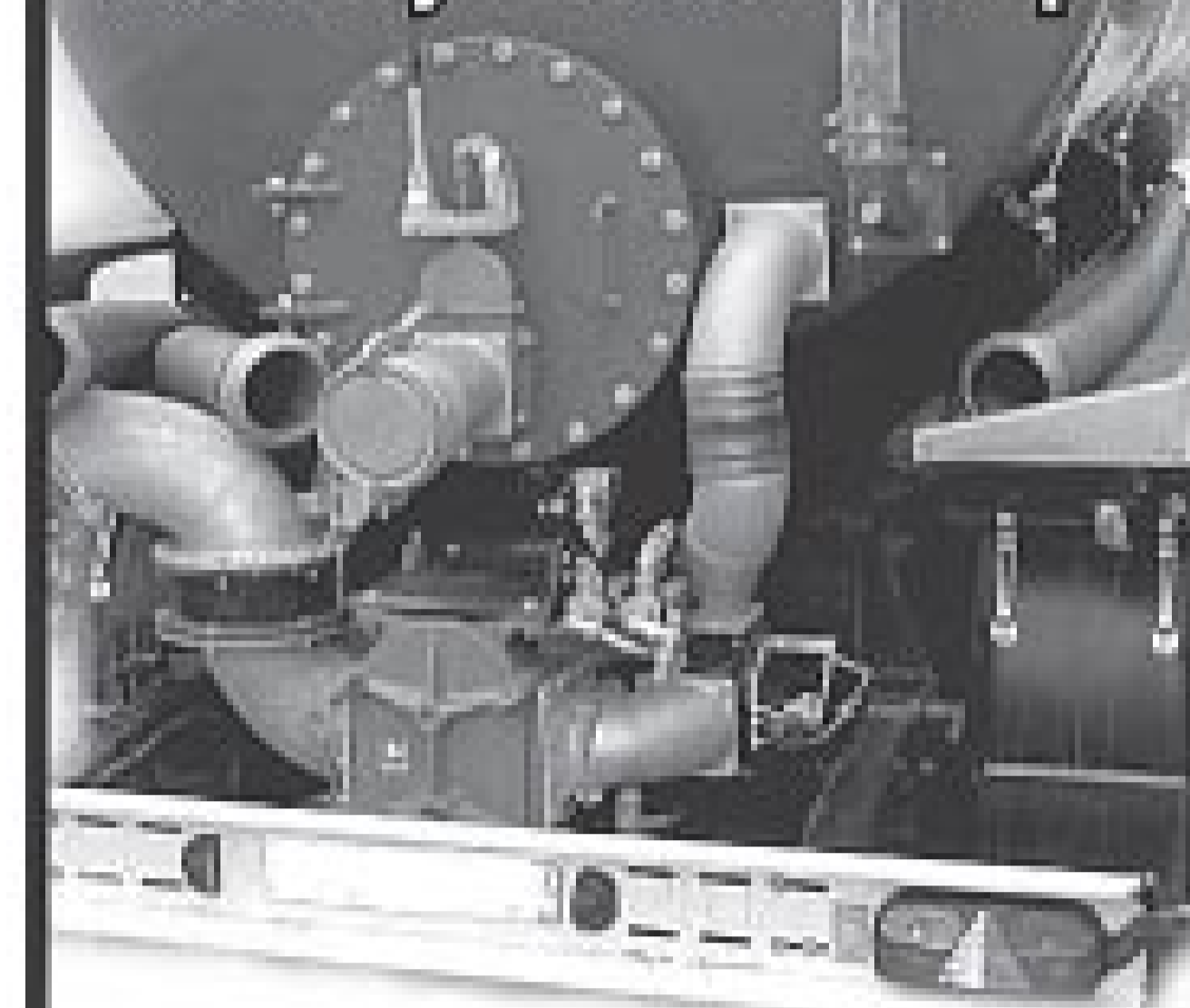

Technical Features:

- Self Priming without Vacuum Assist
- Dry Run Capabilities
- Flow Ranges up to 4,400 usgpm



877.726.3743  
www.boerger-pumps.com

Rotary Lobe Pumps  
Macerating Technology

WWW.ROOTERMAN.COM



Franchises available with low, flat fee  
New concept. Call 1-800-700-8062.

FRANCHISE PACKAGE \$7,950.

Have you seen the  
**Pumper  
E-Zine?**

Recycle Tools & Components • Part Management & Maintenance

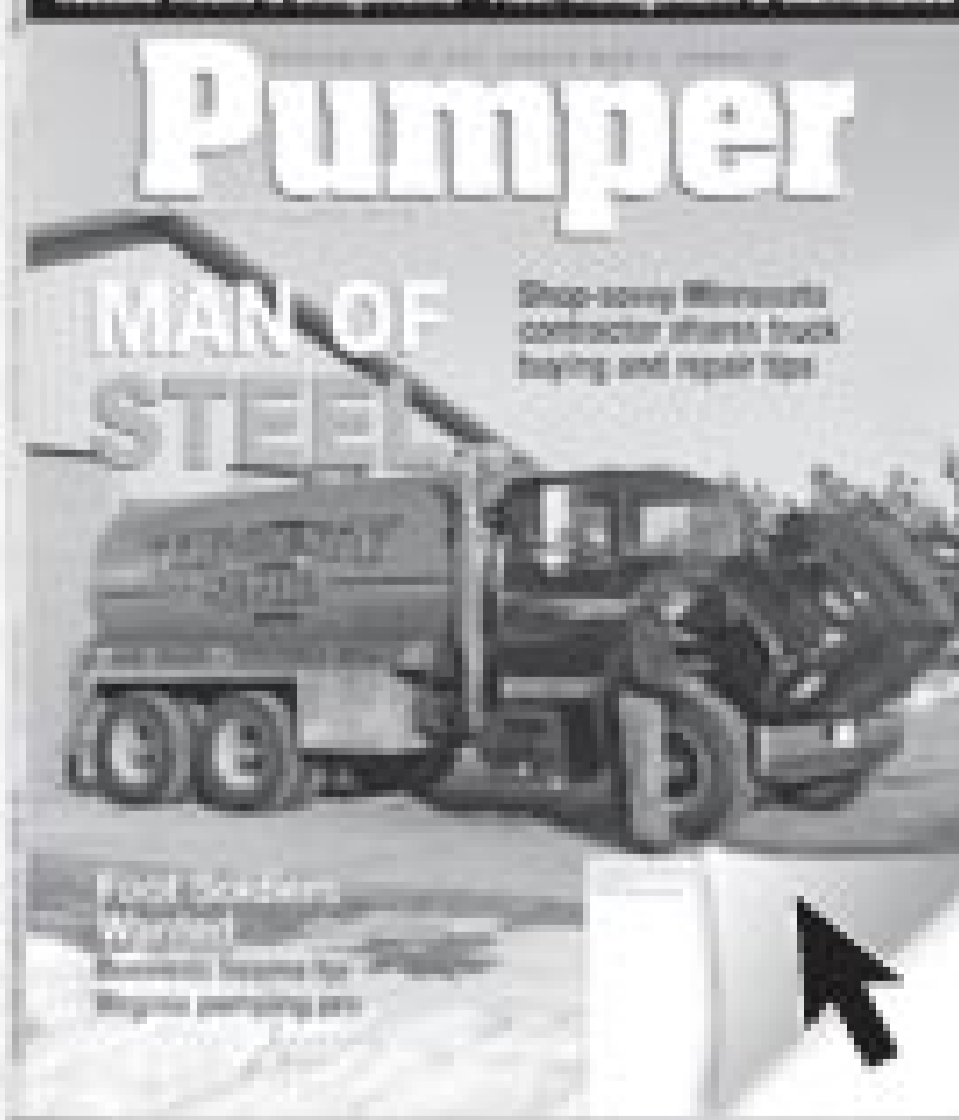

Go to **pumper.com**  
to view the e-zine.

## FIND LEAKS and Sources of Odor

Quick • Inexpensive • Easy  
with the

### Superior® 5E

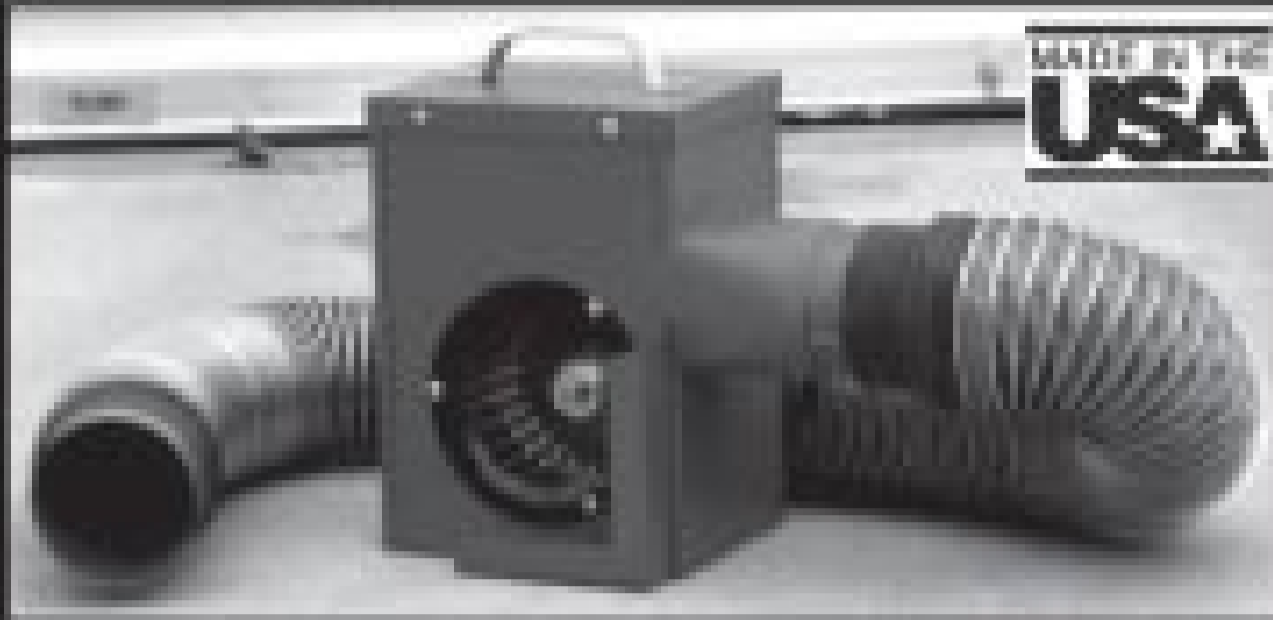

## Electric Smoker

Using Superior® Classic Smoke

1-800-945-TEST

www.SuperiorSignal.com

**NEW** Drainfield Soil Retorative works on the soil **NOT THE TANK!**

- Easy to apply
- Guaranteed to work on sodium bound soil
- Restores soil failed drain fields
- Improves perkability

**RCS II, Inc.**  
518.812.0000  
www.septicdrainer.com

Ask us how the Sanitation Station can make you **money.**

Capital Outlay =

**DROP BOX**  
Custom Modification Specialist

888-388-7768 • 740-532-7822  
www.dropboxinc.com

## WATER JETS FOR RENT

- Units from 4,000 to 40,000 psi, including convertibles
- 60-800 hp, diesel or electric
- Rent, buy or lease
- Branches in MI, TX, NJ, CA, LA

**NLB Corp.** 1-877-NLB-7996  
www.nlbcorp.com

**CONFINED SPACE ENTRY PACKAGE**  
ONLY \$2,995

The best package on the market includes:

- 4-Gas Air Monitor (3 Year Sensor Warranty)
- 7' Tripod
- 3-Way Fall Protection
- Work Winch
- Full Body Harness

Add a Blower with 15' of duct for only \$300!  
Add a 5 Minute Escape Respirator for only \$500!

**MTECH** 800.362.0240  
www.mtechcompany.com

DSL CHEMICAL

### Odor-X tank deodorizer

A natural extract that absorbs and binds odorous compounds

Non-staining royal blue dye with greater masking abilities and less mess.

**Odor-X 80** \$39  
5 gal.

chempace Dealer

dslchemical.com | 509.443.6997

**Drop Box**  
Custom Modification Specialist

888-388-7768 • 740-532-7822  
www.dropboxinc.com

## Aluminum Vacuum Tanks

**ALUMATANK**

progresstank.com

**PORTAVAC**

## Septic & Restroom Service

**Refrigerator Magnets Work!**

Quantity Discounts  
2-color  
Imprint

Stamp Works  
Med Pump Deter.  
800-758-2743

As Low As **35¢**

Pumper Truck Shape  
Actual Size 4 1/2" x 2"

Straight Line Setup **FREE!**

1-800-758-2743

## Wastewater & Sludge Handling

- >Wastewater Treatment Systems
- >Filter Presses
- >Sludge Dewatering
- >Belt Presses
- >Filter Press Parts & Repair
- >Waste Solidification
- >Mobile Wastewater Treatment Systems

**MARTINT ENVIRONMENTAL**

803-796-1190 ♦ Fax 803-796-1171  
www.martintenvironmental.com

## Mobile Dewatering Service

**Municipal & Industrial Sludge Digesters, Lagoons, Ponds, etc.**

- Double Belt Filter Press
- Up to 25% Drier Cake
- Professionally Staffed
- US & Canada

**Fluid Technology, Inc.**

P.O. Box 937, Oxford, OH 45056  
Phone: 513-981-7808  
E-mail: sales@fluidtechinc.net  
Web site: www.fluidtechinc.net

**Anchor Graphics, Inc.**  
Labels & More

- Service Records •
- Portable Toilet Signs •
- Logo Signs •
- Signs (Plastic & Aluminum) •
- Gender Signs •

All types of custom printing and sizes available!  
Check out our great prices!

We Specialize in Waste Management Labeling Solutions

**April is our magnet special month!**  
Call for free offers!!!

**Best Value in the Industry!**

10015 Rearwin Lane McKinney, TX 75071  
sales@anchorgraphics.com  
Phone: 972-422-4300 Fax: 972-422-4311  
(800)875-7859 www.AnchorGraphics.com

## Waterblaster Rentals & Sales

Houston, Texas

**Boatman Industries**

1K to 50K psi  
60 hp to 1000 hp  
Waterblasters & Accessories  
Used Equipment Sales

**713-641-6006**  
www.boatmanind.com

## One Complete Package

pumper.com eq-mag.com  
promonthly.com pumbershow.com  
mswmag.com pumpertrades.com  
cleaner.com septicyellowpages.com  
onsiteinstaller.com sewerpages.com

**COLE Publishing**  
1.800.257.7222 • 715.546.3346

# Pumper. see photos in COLOR at [www.pumper.com](http://www.pumper.com)

# TRUCK STOP



*April*



**2004 Freightliner FL70:** 87,000 miles with NEW 2500 gal. vacuum unit, Challenger 607 liquid cooled vacuum pump. Custom painting. Delivery available.....\$43,000  
**Call 734-777-0390** P4



**1998 Peterbilt 385:** 300 hp Caterpillar, Eaton 9-spd., 3500 gal. steel tank and Jurop R260 pump 2008, new tires and brakes, 12k front, 38k rear, GVWR 50,080. ....\$44,000  
**610-722-5890**  
**E-mail: [greatvalleyssinc@yahoo.com](mailto:greatvalleyssinc@yahoo.com)** P4



**2003 Chevrolet K3500:** Duramax/Allison. 12,000 GVW. 300/150 Lely tank. Thieman liftgate. 245K miles. New frt. brakes, transfer case, batteries. Maintained, 1 owner truck used daily. ....\$15,000 OBO  
**Chris 218-343-0108** P4



**1997 Ford F750:** Reconditioned in 2007, new motor, rebuilt 2500 series Allison auto. trans, cab/tank repainted, Jurop PN33 pump, AC, 1200 gal. tank (800 gal. waste/ 400 ga. fresh), maintenance records available. ....\$18,000  
**Call Tim 1-800-633-7004** P4



**2006 International 4300:** Automatic, 126K, Abernethy tank 1100/400, Masport X75, 2 toilet carrier, 70% tires, very well maintained and ready to work. ....\$34,500  
**504-818-8913** P4



**1993 Vactor 1645, Rebuilt Blower by Guzzler:** 5,000 CFM P.D.; 384,000 miles, power up/down boom. ....\$35,000  
**207-646-2180** P4



**1998 Ford 8511:** 300 hp, 3200 gal. tank, Core 10, DeMag pump, runs great!  
**814-472-7848 - Ask for Dave** P4



**2001 Ford F-550:** 2 WD, auto, Huber tank, 550 waste, 300 fresh, Masport 160 cfm hydraulic driven pump, 192K miles, 45K on new engine, 7.3 liter diesel. Ready for work. ....\$22,000  
**330-763-3706** P4



**STETCO BASIN CLEANERS:** 4 in stock, from city. They run and operate. ....\$8,900 to \$13,900  
 (\$8,900 has no clam shell)

**Opdyke Truck Sales**  
**800-520-4704** PBM



**2007 CHEVY C7500:** High pressure Sreco sewer jet, GVM 25,950, Isuzu diesel, 21K mi., Allison 5-spd. auto, 300 Ford gas rear eng., 2,157 hrs., Meyers pump, 65 gpm/2500 psi, 1"x500' Piranha hose, 1200 gal. water, built-in back flow preventer. Other vehicles available. ....\$40,000  
**631-242-4999** CVP4



**2008 Dodge Sprinter Equipped With Pearpoint Explosion Proof CCTV:** Color pan & tilt camera, small crawler, light head, remote pendant control, camera control system with graphics generator, computer.  
**Call Joe 312-706-9678** P4



**1983 International:** 2500 gal. vacuum septic truck. DT466, runs excellent. 5-spd./2-spd., PS, AB, new front springs, new tires/brakes, 100' 3" hose. Clean, dependable, ready to work. Looks great! ....\$10,500  
**845-863-6080** P4



**1999 IHC 2574 Vac-Con PD4216:** Roots PD blower, Cummins M-11, 10-spd., 46,000 rears, 1300 gal. water, 16-yd. debris body, Cat 3065 upper engine. Water authority truck, 45,404 miles.  
**814-696-4343, Hollidaysburg, PA** P4



**2006 International 4300:** DT466E diesel, auto, 245/75R22.5 tires, 2-compt. 1500 gal. (1100 waste/400 fresh) tank w/ Masport HXL75 vac pump, portalet stand, tool boxes, LED lights, pumper scent tank, 85% toyo rubber, 4x2. Only 127,000 miles! Like new!.....\$46,500  
**318-995-6341** P4



**1971 Ford L8000:** 33000# GVW, 210 hp Cat 1160, (new 1991) 5-spd. trans., 2-spd. rear, 2200 gal. Coleman, 3' intake, 4' discharge valves, 150 UKAC vacuum/ pressure pump, powered by air shift PTO. ....\$15,900  
**Call Judge Coleman 516-398-5638**  
**Email: [cwjudge@aol.com](mailto:cwjudge@aol.com)** P4



**2004 Ford F550 XLT:** 4X4 diesel, auto, alum. wheels, 120K miles, 600 gal. stainless steel waste tank, 330 gal. poly fresh water tank, 100 gal. poly spray tank w/12V pump and hose reel. New Honda engine w/Conde pump. Stainless steel fold-down restroom carrier. ....\$28,000  
**Frankfort, KS 785-292-4933** PBM

# Pumper see photos in COLOR at [www.pumper.com](http://www.pumper.com)

# TRUCK STOP



April



**2000 Sterling:** 18,000 front, 40,000 rear, 190,000 miles, rubber 40%, 3600 gallon tank, NVE pump, jetter package. Excellent condition. ....\$35,000  
**770-562-9473** P4



**1999 IHC 2554 Vac-Con V-390:** DT-530, Allison auto, 3-stage blower, 1000 gal. water, 9-yd. debris tank, Perkins upper, municipal authority truck, 17,384 miles, 4,673 hrs. on truck, 1,032 hrs. on rear.  
**814-696-4343, Hollidaysburg, PA** P4



**1992 Ford Super Duty:** 15,000# GVW, 7.3 diesel (replaced @ 200K), automatic, 270,000 miles, Coleman 400 gal. skid unit, 300 waste, 100 water, flatbed with power gate, transports 6 units. ....\$9,990  
**Call Judge Coleman 516-398-5638** P4



**1999 Mack:** 350 hp, 10-spd., 18K front, 44K rear, camel back, 130,000 miles, 4000 gal. full open door, Transway vac tank w/hoist and vibrator, 1200 Transway pump. Just inspected, ready to work. Good rubber. ....\$70,000  
**P&P Septic, 1-802-658-6243** P4



**1990 GMC:** 6.2 diesel (Jasper engine remanufactured 15,000 miles), auto - 400/175, Masport, hauls six units, price includes 6-place trailer and ten used Polysan toilets. ....Package price \$12,500  
**Call 989-379-3054 MI** P4



**2004 International/Maxvac 1400 Hydrovac:** HT530 engine, Fuller RTO trans., 12-yd. body, 1300 gal. tank, 980000 BTU burner, 2500 psi @ 18 gpm pump, 3000 cfm blower, 22000 miles, 7484 hrs. ....\$135,000  
**Matt 330-270-0700 x108** CP4



**1999 Isuzu NQR:** Diesel engine, 6-spd. manual trans., Masport HXL3V pump, AC, 900 gal. tank (300 fresh/600 waste), maintenance records available. ....\$18,000  
**Call Tim 1-800-633-7004** P4



**2005 F350 XLT:** 6.0 diesel, auto, 500/225, Masport, galvanized troughs, hauls two toilets, 160,000 miles. ....Price \$24,500  
**Call 989-379-3054 MI** P4



**BRAND NEW 2008 Ford F-550 Portable Restroom Truck:** Auto trans., powerstroke motor, brand new 1100 gallon tank w/new Masport M2 pump. ....\$49,500  
 See full inventory at [PumperTruckSales.com](http://PumperTruckSales.com).  
**JR. @ 720-253-8014** P4



**1998 International 4700:** Keith Huber steel tank 1100/400, DT466 auto, just completed rebuild, new paint, 349,035 miles, original owner. ....\$30,000 OBO  
**770-439-2888** P4



**2008 Ford F-550:** 60,000 miles. ...\$46,000  
**1-800-592-3308**  
**270-832-3793 Rodney's Cell** P4



**2002 Dodge 3500:** 6 cyl. Cummins, 2 WD, auto, 172,000 miles, 375 waste tank, (2) 75 gal. water tanks, Honda motor driven M2 Masport, dual toilet rack. ....\$10,500  
**Call 218-751-9453** P4



**2010 Peterbilt 340:** Paccar PX-8 (330 hp), Eaton Fuller 10-spd., new 3000 gal. 407/412 ASME code tank, new Fruitland 500 (350 cfm). ....\$150,000 plus F.E.T.  
**936-825-2000** P4



**2003 Freightliner:** Cat 3126, 330 hp, Allison auto, 32,551 miles, Fruitland 500 (350 cfm) pump, 4000 gal. tank. Truck is just like new. ....\$90,000 OBO  
**218-847-4321** P4



**2006 International 7400:** T 530 (310 hp), Eaton Fuller 10-spd., 140K miles. New 3000 gallon full tilt/open D.O.T. 407/412 ASME code tank, new Fruitland 500 (350 cfm). ....\$92,500 plus F.E.T.  
**936-825-2000** P4



**2007 Galbreath Slayer:** 2 box roll off trailer, 80,000 GVWR, air ride suspension, 60,000# main winch capacity, including tandem winch transfer system with 5/8" transfer cable. Excellent condition. .... Asking \$48,000  
**1-888-739-0838 or 205-910-7577** P4

# Pumper see photos in COLOR at [www.pumper.com](http://www.pumper.com)

# TRUCK STOP



April



**2001 Vactor 2110 on a 2001 Int'l:** 10-yd. debris body, 1300 gal. water, 60 gpm @ 2500 psi, 8' hyd. teleboom, debris body flush-out, centrifugal separator, multi-flow, tele/rotating hose reel, remote pendant control, fold-down pipe racks. (Stk. 1621)  
**Call Joe 312-706-9678** P4

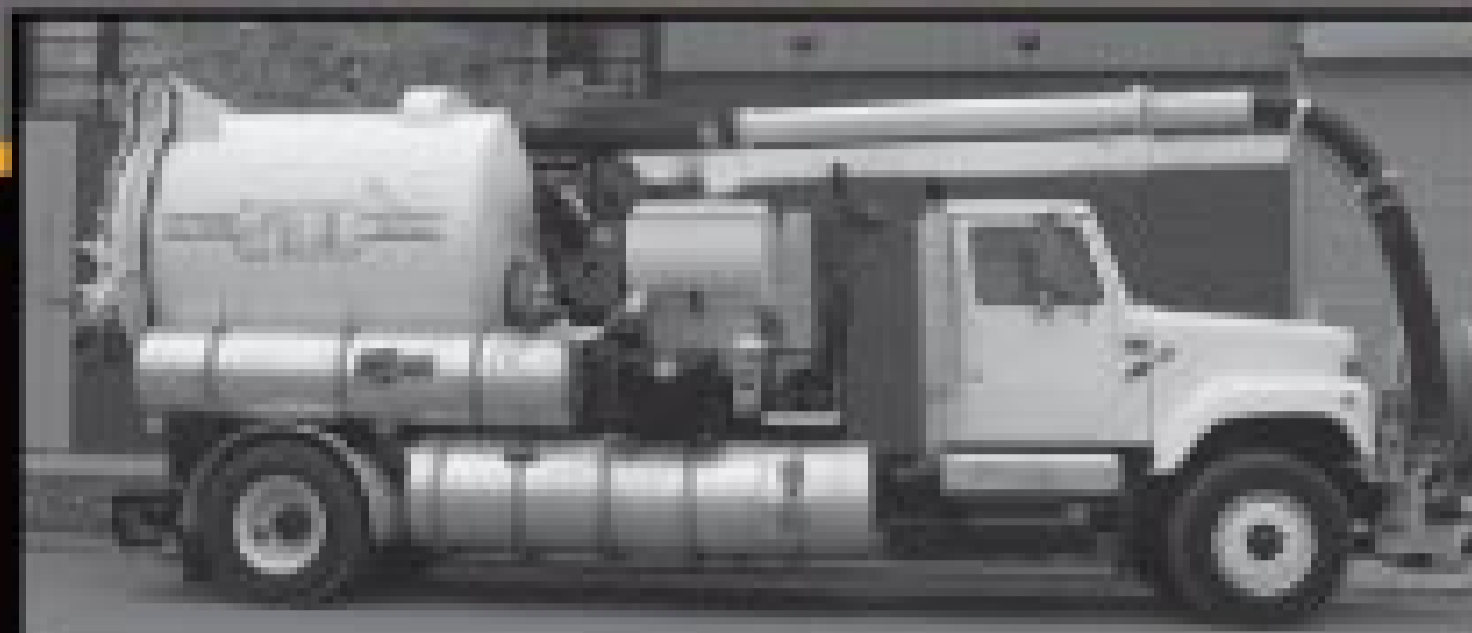

**1997 Vactor 2110 on '98 Intl. 254:** 10-yd. body, 1,000 gal. water, single stage, 60 gpm @ 2000 psi, debris body flush-out, cold weather recirc., 4' hyd. teleboom, tele/rotating hose reel, joystick boom control, auto trans., diesel, 18K fr/23K rr. (Stk. 1618)  
**Call Joe 312-706-9678** P4



**2000 International 4700:** Lane steel tank 800/300, T444E auto, 179,298 miles, very sturdy truck, good shape, ready to work.  
 .....\$30,000 OBO  
**770-439-2888** P4



**2003 Freightliner FLD-120:** Cat 430 hp, Jake brake, 10-spd., 245K miles, new 4000 gal. tank, new Juroop LC420 liquid-cooled pump, 1-yr., 100K mile engine warranty .....\$68,000  
**www.nationaltruckcenter.com**  
**Office: 305-691-8407**  
**Michael Vera: 786-554-0892**  
**George Gonzalez: 954-558-0816** P4



**1994 Ford L8000 Dumping Presvac Truck:** Cummins 8.3L @ 250 hp., 9-spd., 1994 Presvac tank, 3,300 gal. cap., 20' manway, 4' suction, Fruitland pump, Hendrickson RT susp., 22.5 tires, spoke wheels, hazardous placarded. NEW PAINT.  
 .....\$29,500  
**715-546-2680** PBM



**1999 International 4700:** 54,000 miles, 6+1 transmission, DT466E, 2,000 gal., Rovac pump, 100 plus feet of 4-inch hose. Ready to work!.....\$24,000 OBO  
**203-746-3690**  
**or email Bill.R.418@ATT.NET** P4



**2003 Mack CX Vision:** E-7 427 hp, Jake brake, 10-spd., new 5000 gal. tank, new Juroop LC420 liquid-cooled pump, new paint.....\$78,500  
**www.nationaltruckcenter.com**  
**Office: 305-691-8407**  
**Michael Vera: 786-554-0892**  
**George Gonzalez: 954-558-0816** P4



**2002 International 4300:** Progress aluminum tank 1700/300, DT466 auto, 225,625 miles, a real work horse, good paint/body.....\$35,000 OBO  
**770-439-2888** P4



**2004 Mack CX Vision:** E-7 460 hp, Jake brake, 13-spd., new 4000 gal. tank, all new accessories, new paint, aluminum wheels.  
 .....\$76,000  
**www.nationaltruckcenter.com**  
**Office: 305-691-8407**  
**Michael Vera: 786-554-0892**  
**George Gonzalez: 954-558-0816** P4



**1996 International 9200 Dumping Presvac Truck:** Detroit 60 series @ 330 hp, Spicer 10-spd., (00) Keith Huber body w/4,396 hrs., 3,249 gal. cap., air ride, new 22.5 recaps, disc wheels, new paint, hazardous placarded.....\$59,500  
**715-546-2680** PBM



**1999 Ford F550 4x4:** Diesel, auto, 335,000 miles, 600 waste/300 fresh, NVE 1984 vacuum pump, Theiman power lift gate. Still use daily. ....\$18,000 OBO  
**989-746-0009** P4



**2001 Chevrolet 3500:** 4 WD, Allison auto, 150,000 miles, 10' alum. flatbed w/400 gal. waste tank & (2) 90 gal. water tanks. Honda motor driven M2 Masport, dual toilet rack. ....\$11,000  
**Call 218-751-9453** P4



**1994 Volvo GM:** Used 3150, full tilt/ opening rear door, non code, relined vacuum tanks on used chassis, new Fruitland 500 (350 cfm). 3 to choose from. ....\$39,000  
**936-825-2000** P4



**Portable Transport Trailers:** 13' tires, 23' high. **April Special:** 8 restroom hauler \$4,000; 10 restroom hauler \$4,500; 14 restroom hauler \$5,300; 16 restroom hauler \$5,700; 20 restroom hauler \$6,500.  
**1-800-592-3308**  
**Rodney Cell 270-832-3793** P4



**2005 International 8600:** ISM Cummins (375 hp), Eaton Fuller 10-spd., 204K miles, 3000 gallon full tilt/rear opening door D.O.T. 407/412 ASME code tank, Fruitland 500 (350 cfm) .....\$85,000  
**936-825-2000** P4



**2003 Mack CH:** E-7 330 hp, 10-spd., low miles, new 4000 gal. tank, new Juroop LC420, new accessories, aluminum wheels, ready to go! .....\$65,000  
**www.nationaltruckcenter.com**  
**Office: 305-691-8407**  
**Michael Vera: 786-554-0892**  
**George Gonzalez: 954-558-0816** P4



# Pumper see photos in COLOR at [www.pumper.com](http://www.pumper.com) TRUCK STOP



April



**1995 GMC Dumping Vac/Pressure Washing Truck:** Cat 3116, 250 hp, beam susp., 9-spd., air brakes, locking diff., 16K/40K axles, dumping vac tank, 22.5 tires, Nash vac unit driven by Cummins dsl., Supra Hot pressure wash sys. w/1,545 hrs., 4" outlet or full open rear discharge. ....\$29,500  
**715-546-2680** PBM



**2006 Peterbilt 378:** Cat C-13 445 hp, Jake brake, 10-spd., new 5000 gal. tank, new Juroop LC420 pump, 20K tag axle, aluminum wheels. Call for more info.  
**www.nationaltruckcenter.com**  
**Office: 305-691-8407**  
**Michael Vera: 786-554-0892**  
**George Gonzalez: 954-558-0816** P4



**2006 Safetrac - Two (2) To Choose From:** Sterling LT9511 chassis, MBE 460 engines, 27" Wispair blowers, OMSI transfer cases. ....Special Price \$139,950 Each  
**Call 1-888-739-0838** P4



**Brand New 30-Yard Dewatering Box:**  
.....\$24,000  
**www.dewateringofnewengland.com**  
**800-379-5977** P4



**1998 International 4700:** 25500# GVW, DT466E, 175 hp, Allison auto, 272K miles, Coleman KA950 3-comp. (650 waste/200 water/100 wash water), 150 cfm pump powered by hot shift PTO.....\$16,900  
**Call Judge Coleman 516-398-5638**  
**Email: cwjudge@aol.com** P4



**1998 International:** DT466 engine, 7-spd. trans., 2500 gal. tank, Abernethy rig, 105,000 miles. Super clean!  
.....Asking \$32,500  
**410-320-5715** P4



**1999 Ford F-450:** 850 gal. Satellite tank, 2-toilet rack, Conde Super 6 pump, 4WD. Call for more pics and questions. \$13,500  
**JR. @ 720-253-8014**  
**www.pumpertrucksales.com** P4

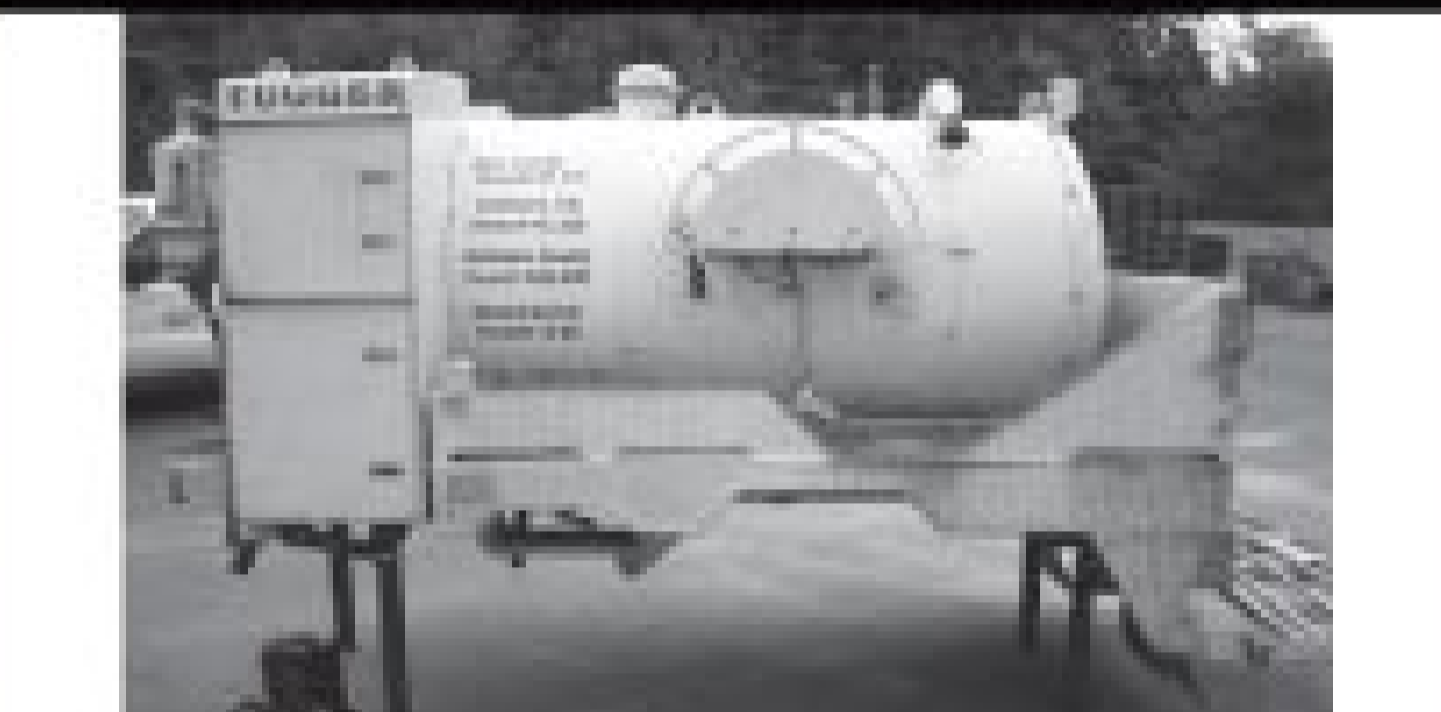

**USED 2000 Keith Huber 600/300 Gal. Tank:** Very good condition, includes tool-boxes, Shor Flo fresh water pump, 2-toilet carrying rack and Masport pump model HXL4DE. ....\$6,500 OBO  
**410-365-1109** P4



**1995 International Vacuum Tank Truck:** 3500 gallon capacity, one owner, garage kept, new paint, tires 70%, with hoses, ready for work. ....\$40,000 OBO  
**610-797-0630** P5



**Freightliner 1998 FL60:** 650W 300F, deck on back with lift gate, hauls 4 toilets, Masport pump, Pumptec electric power-washer, Reel Craft hose reel, 203,000 miles. ....\$22,500 OBO  
**419-262-5769** P4

**THIS SPACE CAN BE YOURS!**  
  
Just go to  
**www.pumper.com**  
or **www.pumpertrader.com**  
and fill in the online form.



**Take \$15,000 Off!**  
Hard to find TST Liquid Ring Vac Truck! 2005 Freightliner w/only 160K miles! Cat 7 engine; full ACME coded 3500 gal tank w/2300 psi jetter; must see to appreciate!  
.....Only \$144,999  
**865-805-4662** P4

**YOUR AD CAN BE ONLINE AND IN PUMPER AND PUMPER E-TRADER FOR ONLY \$125!**

**JUST GO TO [WWW.PUMPER.COM](http://WWW.PUMPER.COM) or [WWW.PUMPERTRADER.COM](http://WWW.PUMPERTRADER.COM)**

**AND FILL IN THE ONLINE TRUCK STOP FORM!**

PLACE YOUR AD ONLINE AT [www.pumper.com](http://www.pumper.com) - IT'S ALWAYS THERE TO MEET YOUR BUSY SCHEDULE



# I'm proud of my industry.

I belong to an elite group of business people who keep homes and communities safe, clean and healthy. My colleagues and competitors are true professionals who care about their work and about customers' welfare. Members of this industry are some of my greatest role models and best friends.

I work with the greatest people in the world.

## Lead the way

*For your customers,  
your industry,  
and your business*

# Mid-Continent Truck Sales, Inc.

891 Adkins Hill Rd. • Norman, OK 73072 • 405-329-5365 • Fax: 405-329-5381 • After Hours: 405-826-4469 • www.vacuumtrucksales.com

## Trucks - Trailers - Vacuum Tanks - Pumps



2003 IH 4400, DT466E (215 hp), 6-spd., 33K GVW, new Wally 403HR vacuum pump, new 2300 gallon vacuum tank.



1992 Ford F900, Diesel 210 hp, Allison auto., air brakes, Moro vacuum pump, 2500 gallon vacuum tank.



1998 Freightliner FL60, Cummins 5.9 (210 hp), 6-spd., Masport H75V vacuum pump, General 47 series triplex, 1100/200 gallon vacuum tank.



New Fluidmaster 5460 gal. vacuum trailer in stock. Also several used vacuum trailers in stock.



1999 IH 9900, Detroit 60 series (430/500 hp), 10-spd., new Wally 753LN vacuum pump, new 3000 gallon vacuum tank.



1989 Chevrolet C70, 8.2 ltr. diesel, 5+2 air brakes, double frame, MEC 5000 vacuum pump, 1500 gallon vacuum tank.



2001 IH 4700, DT466E, Allison auto., non-CDL, 75K miles, new Wally 403HR vacuum pump, new 1600 gallon vacuum tank.

### CALL US BEFORE YOU BUY!

#### MID-CONTINENT TRUCK SALES

manufactures and stocks all necessary components to complete your vacuum system.

Whether it's pumps, valves, moisture traps, oil catch mufflers, pump frames, etc.



**NEW 3800, 3400, 3000, 1600 GALLON VACUUM TANKS IN STOCK!**

**KP**  
Pumps  
Since 1946



**Masport**

**NVE**



**vallenstein**  
vacuum pumps

**BOWIE**



FLUID AND SLURRY  
**PUMPS**

WE CARRY MOST BRANDS OF VACUUM PUMPS AND PARTS!



**WE WILL BUILD TOILET UNITS TO YOUR SPECS!**

Call DAVE PERRY for TRUCK quotations and ED PERRY for TANK quotations.

# Pumper® CLASSIFIEDS

April  
2010

- ▶ Advertising
- ▶ Aerators
- ▶ Bucket Machines
- ▶ Businesses
- ▶ Business Opportunities
- ▶ Cable Machines
- ▶ Computer Software
- ▶ Dewatering
- ▶ Drainfield Restoration
- ▶ Drain / Sewer Cleaning Equipment
- ▶ Dredges
- ▶ Excavating Equipment
- ▶ Hazardous Waste Units
- ▶ Hydroexcavation
- ▶ Jetters-Trailer
- ▶ Jetters-Truck
- ▶ Jet Vacs
- ▶ Lease Financing
- ▶ Locators
- ▶ Miscellaneous
- ▶ Parts & Components
- ▶ Pipeline Rehabilitation
- ▶ Portable Restrooms
- ▶ Portable Restroom Sinks
- ▶ Portable Restroom Tanks
- ▶ Portable Restroom Trailers
- ▶ Portable Restroom Trucks
- ▶ Positions Available
- ▶ Positions Wanted
- ▶ Positive Displacement Blowers
- ▶ Pressure Washers
- ▶ Pumps-Dredge
- ▶ Pumps-High Pressure
- ▶ Pumps-Submersible
- ▶ Pumps-Vacuum
- ▶ Pumps-Water
- ▶ Rodding Machines
- ▶ Roll-Off Containers
- ▶ Roll-Off Trailers
- ▶ Roll-Off Trucks
- ▶ Root Control
- ▶ Safety Equipment
- ▶ Septic Tank Forms
- ▶ Septic Trucks
- ▶ Service / Repair
- ▶ Slide-In Unit
- ▶ Sludge Applicators
- ▶ Tanks
- ▶ Tools
- ▶ Trailers- Vacuum / Tanker
- ▶ TV Inspection
- ▶ Vacuum Loaders
- ▶ Vanes
- ▶ Vehicle Tracking
- ▶ Wanted
- ▶ Wastewater Transfer
- ▶ Waterblasting

## ADVERTISING

### SANITATION POSTCARDS & BUSINESS CARD MAGNETS:

Remind your customers and prospects with color postcards and magnets. Economical marketing tools. Tradeshow handouts as well. Call 781-844-8600. Visit [www.sanitationpostcards.com](http://www.sanitationpostcards.com). (PBM)

## BLOWERS

**VFC200P-5T, FUJI** Pumps, Regenerative Blowers, Ring Compressors. All models, accessories. Authorized distributor. Authorized parts and repair center. Call 888-227-9822. [www.carymfg.com](http://www.carymfg.com). (PBM)

Hibon blower 8702. Huge 5150 CFM @28" hg. Brand new. 2008. Never used. Bought it for a project that we did not finish. Manifold included. Paid \$32,000. Must sell. \$24,000. David @ 514-944-0600. (P5)

## BUSINESSES

**BACKHOE, SEPTIC PUMPING, INSTALLATION BUSINESS:** Central Illinois. Established 15 years. Great for father/son, husband/wife. Most work is in a 30-mile radius. Very nice, wealthy town; great schools. 25 miles from University of IL. MUST, MUST SELL ... HEALTH REASONS AND AGING OWNERS. Don't let this pass you by. This business has more potential for growth and expansion, we just do not have the stamina to go larger. Will train and get you licensed. \$120,000. 217-417-0374. (P4)

**Looking to sell your industrial cleaning, hydroexcavation or waterblasting business?** We have buyers. Must have gross revenue in excess of \$1,000,000 annually. Nationwide interest. E-mail [jeffb@colepublishing.com](mailto:jeffb@colepublishing.com) or call 800-257-7222 and ask for Jeff Bruss for more details. **A B2 Business Brokerage Listing.** (PBM)

## BUSINESSES

**Looking to sell your business?** We can effectively market your business to more than 100,000 potential buyers in the liquid waste, portable sanitation, and sewer & drain industries, as well as your local markets, the Internet and other venues. No upfront fees — you don't pay unless your business sells. To learn more about brokering your business through B2 Business Brokers powered by Pumper, call 800-257-7222. (PBM)

**BOISE, IDAHO AREA:** Good business but owner wants to retire. No blue sky. Value is in equipment. Portable toilet & septic pumping business for sale. 150 toilets, delivery trailers, 2 service trucks, 2 septic pumper trucks. Includes toilets out in service. \$150,000. Call 208-867-9862. (PT4)

Septic Cleaning Business in SW MN. 30 years in business, approx. 700 customers. 1993 IH 9300 truck w 1997 Balzer 1800 gallon tank with locators, hoses, etc. \$42,900. Ph 507-920-3959. (P4)

Portable Toilet Company in Southeast - 4 route trucks, 2 pumper/delivery trucks, approximately 650 portable toilets, holding tanks, stand alone sinks, 2 Synergy HiTech units on trailer, plus miscellaneous equipment. Serious inquires only 1-877-658-0982. (P6)

**Houston Texas Area Septic & Drain Business For Sale.** Grossing nearly \$300,000 annually and showing growth. Established commercial clients and customer list. Includes all equipment to operate, a turn-key business. Huge potential, owner is motivated and moving on - **asking \$140,000.** E-mail [jeffb@colepublishing.com](mailto:jeffb@colepublishing.com) or call 800-257-7222 and ask for Jeff Bruss for more details. **A B2 Business Brokerage Listing.** (PBM)

**Dallas/Fort Worth Texas Area Sewer/Rehab Business For Sale.** Drain Cleaning, TV inspection, Pipeline & Manhole Rehab/Relining, Municipal Cleaning and Maintenance business for sale. Excellent opportunity to expand or start your own business. Good revenue history and priced to sell. Includes all equipment to get started. **Offered at \$150,000.** E-mail [jeffb@colepublishing.com](mailto:jeffb@colepublishing.com) visit [www.Btwo.biz](http://www.Btwo.biz) or call 800-257-7222 and ask for Jeff Bruss for more details. **A B2 Business Brokerage Listing.** (PBM)

## BUSINESSES

Well-established and profitable Ct. septic pumping & installation plus portable toilet business for sale. Grossing in excess of \$270,000 annually, customer list of 3,000+/- . Includes new custom pump truck and toilet truck. Asking \$549,500. [kernhout@capitalbbw.com](mailto:kernhout@capitalbbw.com) or call 203-417-1692. (P4)

**Massachusetts Sewer & Drain Franchise For Sale.** Confidential listing, Non Disclosure Agreement required. Turn-key business, good revenue — **asking \$165,000.** E-mail [jeffb@colepublishing.com](mailto:jeffb@colepublishing.com) or call 800-257-7222 and ask for Jeff Bruss for more details. **A B2 Business Brokerage Listing.** (PBM)

**BUSINESSES WANTED:** Septic pumping, grease trap, drain cleaning and other ancillary businesses wanted. We are buying well run businesses in New England, Mid-Atlantic and Florida. All opportunities will be given proper consideration. Confidentiality ensured. Will move quickly for the right opportunity. Serious inquiries only. Please contact Richard Bedard @ Blue Water, 617-326-3344 or [rbedard@bwseptic.com](mailto:rbedard@bwseptic.com). (CPBM)

**Philadelphia/Allentown Pennsylvania Area Sewer Business For Sale.** Specializing in collection systems, video inspection, jetting, municipal work. Includes CUES TV & grout truck, Sewer Equipment Corporation jetter truck, Vactor 2100, RIDGID camera, confined space equipment and more! Good revenue history. Great opportunity to expand or start your own business. Current owner wants to retire. **Offered at \$330,000.** E-mail [jeffb@colepublishing.com](mailto:jeffb@colepublishing.com) or call 800-257-7222 and ask for Jeff Bruss for more details. **A B2 Business Brokerage Listing.** (PBM)

Growing Septic & Port-A-Potty business for sale in beautiful Truth or Consequences, NM. Expanding area with Spaceport and NASA raceway under construction. Includes business, two septic trucks, port-a-potties. \$87,000. Call Steve 575-740-2526. (P4)

**ARIZONA BUSINESS WANTED:** Qualified buyer looking to purchase existing industrial/municipal cleaning and inspection business in the Phoenix area. Will consider other areas in Arizona as well. If you are looking to sell, please call Jeff at 800-257-7222. (P6)

## BUSINESSES

**PORTABLE RESTROOM BUSINESS:** Front Range, CO. 360 toilets, 2 handicap, 8 wash stations, 3 trailers, 2 professionally built trucks. Family owned and operated 18 years. 719-499-8335. (PTBM)

Family owned portable toilet business. Owner with health issues forces sale. 500+ units, 4 service trucks, located in beautiful Sacramento, Calif. area. 16 years established business, loyal customers. Serious inquiries only. Leave message; will return calls. 916-343-3326. (PBM)

**Looking to buy a business** in the liquid waste, portable sanitation, or sewer & drain industries? Call B2 Business Brokers powered by Pumper at 800-257-7222 and we can add you to our VIP buyer list. No obligation, no fees, no pressure. (PBM)

**NORTHERN CALIFORNIA/RENO, NEVADA AREA PORTABLE RESTROOM SERVICE BUSINESS FOR SALE.** Owner is motivated and inventory alone is worth the asking price. Includes 100+ restrooms, sinks, ADA units, holding tanks, 2 service trucks and a delivery trailer. Annual revenue in excess of \$100K each of the past 4 years. List of existing customers and contracts included. Owner is willing to train if needed. Asking \$75,000 - **REDUCED TO \$55,000.** E-mail [jeffb@colepublishing.com](mailto:jeffb@colepublishing.com) or call 800-257-7222 and ask for Jeff Bruss for more details. **A B2 Business Brokerage Listing.** (P6)

**North Carolina Septic and Installation Business for Sale.** Showing good growth over the past 3 years. Includes all equipment to operate, extensive customer list, and owner is willing to train if necessary. Asking \$110,000. E-mail [jeffb@colepublishing.com](mailto:jeffb@colepublishing.com) or call 800-257-7222 and ask for Jeff Bruss for more details. **A B2 Business Brokerage Listing.** (PBM)

**Looking to sell your portable restroom business?** We have buyers looking in the following areas; Florida, California, Virginia, Iowa, Kentucky, New York, Pennsylvania and more! Must have gross revenue in excess of \$250,000 in most cases. E-mail [jeffb@colepublishing.com](mailto:jeffb@colepublishing.com) or call 800-257-7222 and ask for Jeff Bruss for more details. **A B2 Business Brokerage Listing.** (PBM)

PLACE YOUR AD ONLINE AT [www.pumper.com](http://www.pumper.com) - IT'S ALWAYS THERE TO MEET YOUR BUSY SCHEDULE

## BUSINESSES

**Well-Established and Profitable Texas Septic, Sewer and Installation Business For Sale.** Grossing in excess of \$1,000,000 annually, customer list of nearly 2,000 accounts and 430 contracted customers. Includes nice late model equipment, most are 2007, 2008 model years. Real estate with rental income can be purchased separately if interested. Asking \$799,000. E-mail [jeffb@colepublishing.com](mailto:jeffb@colepublishing.com) or call 800-257-7222 and ask for Jeff Bruss for more details. **A B2 Business Brokerage Listing.** (PBM)

Portable Toilet Company for sale in Suffolk County, NY. 2 porta-pottie trucks (service & delivery), 2 trailers (10 units & 12 units), 75 portable toilets, 5 handicap units, 2- 4 person handwash stations, 300 gallon holding tank. Asking \$95K - serious inquires only. Call 631-472-1487. (PBM)

## BUSINESS OPPORTUNITIES

How would you like to reduce your fuel expense and/or sell the waste oil that many restaurants simply throw away? If so, call John at Arcade Pumping Service LLC/ Coulee Region Biofuels. We can handle design, mechanics, and marketing plans for your business. Price varies. Please call 608-525-4225. (P6)

**National Grease Recycling Inc.** Let us teach you how to recycle restaurant's waste fryer grease and oil (yellow grease) only. **No trap grease.** Big \$. Over 30 yrs. experience. Will guide you through complete process from collection to processing to marketing to end users. Don't lose your trap business to competitors that offer both services. We also buy cooking oil, unprocessed, anywhere in the country. Call for information. Dewey Walker. 813-752-9535 or 813-758-2552. (PBM)

**Looking to sell your business?** We can effectively market your business to more than 100,000 potential buyers in the liquid waste, portable sanitation, and sewer & drain industries, as well as your local markets, the Internet and other venues. No upfront fees - you don't pay unless your business sells. To learn more about brokering your business through B2 Business Brokers powered by Pumper, call 800-257-7222. (PBM)

## BUSINESS OPPORTUNITIES

**BE YOUR OWN BOSS!** Start your own portable restroom company! 100 portable toilets and a service truck for only \$25,000. Call 505-345-3965 today! (PT4)

**WWW.ROOTERMAN.COM.** Franchises available with low flat fee. New concept. Visit web site or call **1-800-700-8062 x26.** (CPBM)

ROTO-ROOTER franchise for sale in TN. This area consists of Putnam and Cumberland counties. It includes the cities of Cookeville and Crossville. Contact Philip Harbin 423-593-2169. (P5)

**Attention PolyJohn Owners:** Receive a **free CD-Rom** of our products to use in your company marketing efforts. Ask your PolyJohn business coach in your area to send you this material today. 1-800-292-1305 Kell. (PBM)

**Looking to buy a business** in the liquid waste, portable sanitation, or sewer & drain industries? Call B2 Business Brokers powered by Pumper at 800-257-7222 and we can add you to our VIP buyer list. No obligation, no fees, no pressure. (PBM)

## COMPUTER SOFTWARE

Pumper Plus Billing Software: Regularly \$795. Mention this ad in Pumper.com and purchase for only \$595. Pumper Plus is a billing software package from Galaxy Systems, [www.galsys.com/pumperdemo.asp](http://www.galsys.com/pumperdemo.asp), that handles billing for septic pumping and portable toilet service-type companies. Inquire at [solutions@galsys.com](mailto:solutions@galsys.com) or call 800-985-3029. (PBM)

## DEWATERING

**DISSOLVED AIR FLOTATION UNITS:** 150 GPM stainless steel, \$25,000 FRC; 100 GPM Martint carbon steel (new); 75 GPM circular DAF carbon steel, \$15,000. **FILTER PRESSES:** 35 cubic foot Netzch, \$17,000; 20 cubic foot Netzch, \$13,000, 100 cubic foot JWI w/mezzanine, \$90,000; 125 cubic foot JWI w/mezzanine, \$110,000, new condition, auto place shifter; 30 cubic foot Netzch w/mezzanine, \$40,000, new condition w/plate shifter Many other sizes available. For more information, call Clay @ 803-422-6230. (P5)

## DEWATERING

Contractor Dewatering Package: One owner, custom built, 1999 - 3.0m Bright Technologies belt filter press, complete skid system, (Serial # B99080103), 500 GPM sludge pump, liquid emulsion polymer system, stainless steel construction, pneumatic belt steering & tensioning, touchscreen controls, new belts, new washwater booster pump, 7125 hrs. on system, includes 3 conveyors, (one - cross conveyor, one - forwarding conveyor, one - 14' discharge height load-out conveyor), Badger Flowmeter, 125KW multiquip portable generator (5,750 Hrs), portable support tankage also available. \$235,000. Call Jerry @ 920-988-2085 or email: [tra9jac@sbcglobal.net](mailto:tra9jac@sbcglobal.net). (P4)

Buy - sell - trade - lease: Filter presses, belt presses, vacuum filters, filter cloth, dewatering bags, tanks, mixers and more! Call Waste Treatment Equipment Specialties at 440-808-8844. **www.wescoequip.com.** (PBM)

**ALAR 660 AUTOVAC DEWATERING PLANT.** HUGE SAVINGS ON DISPOSAL COSTS!!! MUST SELL. Price reduced to \$50,000. Complete plant, like new. Vac skid with electrical control panel, fully automated system. Grease interceptor and septic separation primary use. All electric, location plans, manuals. Too much to list! CALL TODAY. 808-848-1569. (P4)

## DRAINFIELD RESTORATION

**Soil Shaker 2000.** Universal skid steer attachment for drainfield restoration. Buy factory direct \$5,950. [www.soilshaker.com](http://www.soilshaker.com) or call 320-293-6644. (PBM)

**TERRALIFT 2000:** 2002 model year, 228 hours, excellent condition. \$17,500. 574-256-1465 or 574-532-3559. (P5)

**SELLING DUE TO MEDICAL REASONS:** 1996 Terralift unit in great shape. Unit, trailer, extra probe, beads. \$10,000. Call Chuck 515-321-2366. (P6)

1996 Terralift, completely restored! Looks brand NEW. Runs good. You won't be disappointed. Asking \$12,000. Can deliver. 715-246-5738. (P4)

## HAZARDOUS WASTE UNITS

2010 Peterbilt 340s with new Presvac 3200 gallon carbon steel, DOT 412 certified, full open rear door, dump style units. PVB750 vacuum pumps. *In production.* (Stock #13384 C, D & E) **www.VacuumSalesInc.com, (888) VAC-UNIT (822-8648).** (PBM)

ATTENTION: Fleet of Mack vacuum waste oil trucks. Assorted size MC312 aluminum vacuum tanks. Accepting trade offers or highest bids. 417-619-5111. (PBM)

1987 Pete 379 with Presvac 3000 gal. stainless steel dump/door, DOT certified vacuum tank, Presvac PV750 pump, Cummins big cam with alum. budds. KLM Companies. 617-909-9044. (P4)

2003 Freightliner, Cat engine, 412 hp, 13-spd., Jurop pump, 4,000 gal. DOT 412 cert. Amthor tank. \$65,000. Call JR. @ 720-253-8014; [www.pumpertrucksales.com](http://www.pumpertrucksales.com). (P4)

NEW Presvac 5500 gallon c/s DOT certified vacuum tank trailer unit, with a PV750 pump, Deutz diesel. (Stock #13373) **www.VacuumSalesInc.com, (888) VAC-UNIT (822-8648).** (PBM)

2011 Freightliner M2 with new Presvac 3,200 gallon stainless steel DOT certified dump and door vacuum tank. 900 CFM blower, 330 HP. KLM Companies, 617-909-9044. (P4)

1988 IH model 2554 with a Presvac 3,200 US gallon carbon steel tank and PV750 pump. (Stock #4922C) **www.VacuumSalesInc.com, (888) VAC-UNIT (822-8648).** (PBM)

2011 Freightliner M2 loaded options with new Presvac 3,200 gal. stainless steel DOT certified dump and door with Moro PM100 vacuum pump. KLM Companies, 617-909-9044. (P4)

## JETTERS-TRAILERS

1983 FMC Model 3510, Serial # A271134. Powered by a 140 cubic inch industrial Ford gas engine. 300 gallon water tank. Bean pump model 6-60, 35 gpm @ 1800 psi. Approximately 350' of 3/4" hose. Starts and runs great. Asking \$5,500. Located in MI. 989-753-9971. Ask for Bob or Tom. (P4)

## JETTERS-TRAILERS

2 SECA trailer jets. Both have Myers 35 gpm, 2000 psi pumps. New paint on both. Located in Dallas. 972-938-1905. [www.empireequip.com](http://www.empireequip.com). (CPBM)

2002 US Jetting, 300 gallon, 4000 PSI, Hatz engine, hydraulic pivot hose reel, serviced regularly, 2090 hrs. Works perfectly. \$16,400. 330-351-4353. [patflynn2@aol.com](mailto:patflynn2@aol.com), Akron, Ohio. (P4)

2005 US JETTER OPEN TRAILER 18 GPM, W/4000 PSI., 300 water tank, silent pack, excellent condition. LOCATED IN IOWA. 563-529-3030. [WWW.WULFSSEPTIC@NETINS.NET](mailto:WWW.WULFSSEPTIC@NETINS.NET) (P4)

2003 O'Brien Custom Hydro, Model 10580-SC, Cummins 6BT 6 cylinder 5.9 turbo, Myers FE high pressure pump, 80 gpm, 2000 psi, 600' hose, tandem axle trailer, pintle hitch. \$25,000. Call JD 775-825-1595 or, [jd@watersvacuum.com](mailto:jd@watersvacuum.com). (P4)

Xtreme Flow Cold Jetter - Model # CJ85-3600TU, tandem axle trailer, 35 HP Vanguard, 8.5 gpm @ 3,600 psi, 325 gal. water tank, 300' hose, General pump. List \$19,995. **Sale only \$14,995. Fully loaded & delivered!** 800-624-8186; [www.hotjetusa.com](http://www.hotjetusa.com). (CP6)

1975 O'Brien Jetter. New 500 gal. steel water tank. 4 cylinder Wisconsin model #VG4D. About 550' of 3/4" hose in good shape. Has FWI pump 28 GPM @2000. Asking \$6,200. Located in MI. 989-753-9971. Ask for Bob or Tom. (P4)

## JETTERS-TRUCKS

2008 Camel Super Products 2000 Peterbilt combo truck. Cat C13. 16 yard combo unit. 2000 psi 80 gpm hydro. 1,472 hours. 15,758 miles. 2 tag axels. \$275,000. Call J.D. at 775-825-1595 or [jd@watersvacuum.com](mailto:jd@watersvacuum.com) for photos. (P5)

2006 GMC TC6500 cab & chassis truck mounted jetting unit with JET EYE camera system, 3,000 psi @ 50 gpm, 1,000 gallons water, 600' hose, 500 cfm blower, debris tank and attachments. **Available for purchase or rent!!!** (Stock #13234) **www.VacuumSalesInc.com, (888) VAC-UNIT (822-8648).** (PBM)

## JET VACS

2008 Sterling LT7501 with a Vac/All All Jet Model AJV1215 1500 water comp, 12-yd. debris body, Roots 824 PD blower, 80 gpm @ 2000 psi jetting system with 600' of 1" hose. Combination vacuum-jetter unit. **Available for purchase or rent!!!** (Stock #0329V) **www.VacuumSalesInc.com, (888) VAC-UNIT (822-8648).** (PBM)

Jack Doherty Supplies Inc. offers a full range of late model combo units and DOT industrial vacuum loaders. Call us @ 1-800-3DOHENY. (CPBM)

1998 Vactor 2110 on a Freightliner FL80, 28,213 miles, 2-stage fan, 80 gpm, 2,000 psi pump off system accumulator. Was a city owned unit. Located in Dallas. 972-938-1905. **www.empireequip.com.** (CPBM)

2003 Vactor 2110, **PD blower**, 80 gpm, 2500 psi pump, pump-off system, articulating hose reel, extendible boom. Was city owned. In excellent condition. Located in Dallas. 972-938-1905. **www.empireequip.com.** (CPBM)

2007 Vac-Con, 12 cubic yard on International, 1300 gallons, 45,294 miles, 80 gpm. 15' telescoping boom, hydro-excavation package. \$180,000. 888-234-4209. (P4)

## LEASE/FINANCING

**North Star Commercial Credit:** Commercial Loans for Trucks or Equipment. Flexible purchase programs to fit your budget. 21 yrs. in the industry. Contact **Tom Myers - 877-804-2274.** (CPBM)

**BSM Financial Group** is a nationally recognized finance company. We offer flexible payment schedules for all types of equipment new or used. Trucks, pumps, jettors, portable toilets, and software easily financed. We do first time start-ups, established businesses, and challenged credit. **Call Brett at 877-524-7972 or email brett@bsmfinancialgroup.com.** (PBM)

Advertise in Classifieds  
for only  
**\$1.00 PER WORD!**  
at **www.pumper.com**

## MISCELLANEOUS

New custom built rotary screen for processing/screening septic or grease trap waste, also other liquid material. Originally constructed to screen waste prior to land application, 7'X16' containment box, 12'X3" rotary screen. Works extremely well based on 7 years operating experience. \$30,000. Call JD 775-825-1595 or email [jd@watersvacuum.com](mailto:jd@watersvacuum.com) for pictures. (P4)

## PARTS & COMPONENTS

**Pipe, Hoses, Fittings:** Aluminum vacuum pipe, valves, and hose assemblies. Call 800-246-3685. Free catalog. Schumacher Irrigation, Inc. Since 1956. (CP7)

PARTS & SERVICE for vacuum pumps and vacuum tanks. Vacuum pumps also in stock. Chambersburg, PA. 717-709-0000. Ask for Ken or Randy. (PBM)

## PORTABLE RESTROOMS

Satellite, PolyPortables, PJ, Taurus. \$75 - \$175 each depending on condition. Volume discounts. Atlanta area. HTs & Half Johnnies also. 678-542-6137. (P4)

(50) Taurus and Hi-Tech units, refurbished ready to rent, \$225 each, (6) NuConcept units, \$1,795 each, Eastern Nebraska. Call Jeff 402-960-4904. (P4)

Olympic Hi-rise fiberglass portable toilets only use on one job site, \$250 ea. 100 Satellite Tufway construction portable toilets, \$200 ea. Call 573-450-8378 for more information. (P4)

500 used fiberglass toilets. \$50 each. Handicaps also available. Various condition. Great for construction sites! Call Mike 505-345-3965. (P4)

350 used Poly and Satellite portable toilets for sale in Utah. \$250 each, volume discounts available. Contact Ryan at 801-430-7287. (P5)

For Sale: 42 PolyPortable Integra 2007 units, \$325 ea., 38 PolyPortable older units, \$250 ea. 1 250 gallon holding tank, \$125. 1 PolyPortable Tag Along hand wash station, \$275. North Georgia Area CBR # 706-889-0558. (P4)

## PORTABLE RESTROOMS

For Sale: Used hand wash stations (Satellite Industries). Good working condition. \$150. ea. Hundreds in stock. Discounts available on quantities above 25. 562-755-6055. (PT4)

FOR SALE: Used Porta-potties: Green PJ3s and green Synergy World Taurus units. Good to very good condition. \$250 per unit. 573-864-5062 or 573-864-5597. (P4)

Five Peaks, excellent condition, \$350 each. Can arrange shipping. Call 402-217-1118. Nebraska. (P4)

Used PolyJohn, PolyPortable tan units, plastic skids, average to excellent condition. \$225-\$325 each. Can arrange shipping. Call Bob at 1-352-796-4540. (PBM)

Over 600 PolyJohn units 1-2 years old. Starting at \$300 each. Minimum purchase of 26 units. 772-562-4604. [kim@reliablepolyjohn.com](mailto:kim@reliablepolyjohn.com). (PBM)

Satellite TuffWay units, forest green, good shape, \$300 each, 100 available. Delivery available. Located in NE Ohio. 330-763-3706. (P4)

## PORTABLE RESTROOM TANKS

300 gallon, 225 waste/75 water, brand new, Battioni pump. \$5,500. 315-375-7867. (PBM)

Single or multiple compartment tanks. Choose mild, stainless, or galvanized steel. Capacities from 100 to 6000 gallons, any diameter. Parts and accessories to build your own and save money. 800-545-0174. [www.tanksandpumps.com](http://www.tanksandpumps.com). (PBM)

## PORTABLE RESTROOM TRAILERS

2008-ACSI - AD16 skid-mounted restroom, AC/heat, only used for 4 months and like new. Will email pictures and specs on request. \$25,000. Please contact Dan at 408-205-7437. (P6)

Bathroom Trailer: 1-yr.-old, used only for weddings. Women's side has 3 stalls, 2 sinks; men's side has 1 stall, 2 urinals and 1 sink. Equipped with AC, AM/FM stereo, hot water. 608-835-3459. (P4)

## PORTABLE RESTROOM TRAILERS

McKee portable toilet transport trailers, 3-12 pack; 2-6 pack. American Engineering 828 Tonto and 814 Royale, 2 decons. 315-437-1291. (P4)

2004 Ameri-Can mobile restroom trailer Model 824 Oasis. Central air. Very good condition. Can deliver. \$27,850. Call 618 973 9165. (P5)

2008 ACSI - AD16 with MANY upgrades. A/C, heat, hot & cold water. Excellent shape. Glad to email pictures. \$30,000. Please contact Ed at 408-425-7983. (P4)

1999 ACSI 32' Trailer. Women's side is 7 stalls and 4 sinks. Men's is 3 stalls, 3 sinks and 4 urinals. \$24,000. 216-990-6658. (P4)

New and used **RESTROOM TRAILERS** available immediately. 8 to 34 foot luxury trailers. Comforts of Home Services Inc. 877-382-2935. (PBM)

## PORTABLE RESTROOM TRUCKS

1995 International 4700 - 25,500 GVW with 1300 split (1000/300) carbon steel portable toilet service unit, service record available, stored indoors. \$7,500. 800-843-9286. (P4)

1984 Chevrolet G30. Rebuilt motor, new brakes, carb. Richmac 300/100. Excellent backup truck. Ready to work! \$7,500 or B/O. Chris. 218-343-0108. (P4)

2003 Ford F550, runs excellent, 900 gallon tank with new Conde pump. Engine has new injectors and new high pressure oil pump & screen. 189,800 miles. Pictures available upon request. \$19,500. 800-273-5409 Bruce. (P4)

2006 GMC: W-4 diesel, needs engine work, rebuilt automatic transmission, steel tank 700 waste 275 fresh, Masport HXL4V in cab PTO switch, rear carrier, pressure washer with hose reel, bucket holders, deodorant tank plumbed to bucket fill, work lights, 110" WB. \$10,000. 916-698-4283. (P4)

Keith Huber 1999 Isuzu Tugger NQR. I may need a little paint and TLC, but I get up and go to work every day. I also have many newer parts. Six new tires included. \$12,200. Please call 402-291-0220 for more information. (P4)

## PORTABLE RESTROOM TRUCKS

2003 Ford F550, automatic, stainless steel body & tank. 850 waste, 250 water. 100,000 miles. \$22,000. 718-945-6262. (P4)

For Sale: 2004 Ford 550 Portable Restroom Truck with Thieman lift gate, 600 gallon tank, 400 waste & 200 fresh water. 211,115 miles with brand new transmission. Cbr# 706-889-0558. (P4)

1999 Mitsubishi 600/225, auto, A/C, diesel, 242,000. Ready for service. \$9,500. Located in PA. 800-433-2070. (P4)

2004 Int. 4300, stainless, \$42,500; 2002 Int. 4300, \$32,500; 2001 Int. 4700, \$32,500; 2000 Int. 4700, \$25,000; 1998 Int. 4700, \$22,500. 200 restrooms, \$125 - \$300 each. Call 256-757-9900 or visit [www.pbsos.com](http://www.pbsos.com) for more info and pictures. (PBM)

2003 Ford F550 w/600 gallon sewage tank and 200 gallon fresh water tank. 6L diesel, 6 speed manual transmission, \$18,000. Call 573-450-8378 for more information. (P4)

2000 Intl. 33,000 GVW. Automatic. 1000 waste/450 fresh. Toilet carrier. 1999 Freightliner FL70. 33,000 GVW. 7-speed. 1000 waste/450 fresh. Both ready to work and priced at \$20,000 each. 505-345-3965. (P4)

2004 4300 International, 25,500 GVW, DT466, Allison, A/C, air-brakes, 3-compartment aluminum tank (450/1400/250), M-10 water-cooled pump, spot lights, 2 Burk water pumps for fill and spray down, restroom carrier. Pictures [www.aacoinc.com/classified](http://www.aacoinc.com/classified). Location Phoenix, AZ and Las Vegas, NV. \$35,000. 208-362-3193. (P4)

Prime 1,500 US gallon, 2-compartment (1000/500 split) carbon steel; portable toilet service unit. (Stock #3469C) **www.VacuumSalesInc.com, (888) VAC-UNIT (822-8648).** (PBM)

2008 Dodge 5500, Cummins, automatic, 54,000 miles, 1000 waste, 300 fresh, \$52,000. Still under warranty. 2006 GMC Duramax diesel, automatic, 1000 waste, 300 fresh, slide-in tanks 600/200, \$10,000. Portable transport trailers, new and used. Lane's Vacuum Tank, 800-592-3308. Rodney Lane cell 270-832-3793. (PBM)

PLACE YOUR AD ONLINE AT [www.pumper.com](http://www.pumper.com) - IT'S ALWAYS THERE TO MEET YOUR BUSY SCHEDULE

## POSITIONS AVAILABLE

Portable toilet chemical supplier looking to hire 1-3 sales positions. We are growing and need to expand in West, East and Midwest territory and wanting your industry experience. Fax resume to 217-469-2481. (PT5)

Commissioned Sales - Georgia/Alabama markets. Sewer cleaner, jet trucks, vacuum trucks, municipal repairs. Call 1-800-359-7867; Email: davidp@patspump.com. (P4)

Progressive Midwest manufacturer of Vacuum Excavation and Sewer Cleaning equipment is in search of a talented, highly motivated and well connected sales representative. The ideal candidate will have experience in selling directly to the end user in such markets as gas & electric utilities, telecommunications, directional drilling or equipment rental agencies. This opening is prompted by what has been significant growth in both this company's product portfolio as well as its new market penetration. We offer a competitive salary and benefit package and only serious sales professionals need apply. Please respond in confidence by faxing cover letter/resume to 773-913-2247. (P4)

## PRESSURE WASHERS

Commercial Grade Trailer Special - Single axle, hot water trailer unit, 18 HP Vanguard, 5.0 gpm @ 3,000 psi, with 200 gal. water tank, General pump. List \$11,995. **Sale only \$8,995. Fully loaded! Ready to clean!** 800-624-8186; www.powerlineindustries.com. (CP6)

## PUMPS-VACUUM

Need a vacuum pump for your portable pumper? Try our new 30 cfm, 12 volt system. Less noise, no fuel. Automatic oiling, cheaper than a gas engine. 800-545-0174. www.tanksandpumps.com. (PBM)

Vacuum Pumps - New, used, or rebuilt. 30 to 900 cfm. All major brands; air, water, or fan cooled. Rebuild specialists - rebuilt PB, M3, M10, and others available. 800-545-0174. www.tanksandpumps.com. (PBM)

## PUMPS-VACUUM

New **Masport** and **Juop** vacuum pumps. Compare our price before you buy. W-K Machine & Supply Co. Call 1-800-633-8947. Distributor. (PBM)

## RENTAL EQUIPMENT

**KMH Equipment Company** has a full range of late model combo units and industrial vacuum loaders for sale, rent or lease. Visit us at our website **www.kmhequip.com** for a complete listing of our equipment, or call us at **888-564-0202**. (CP4)

Liquid vacs, wet/dry industrial vacs, combination jetter/vacs, vacuum street sweeper & catch basin cleaner, truck & trailer mounted jettors. All available for daily, weekly, monthly, and yearly rentals. **VSI Rentals, LLC, (888)VAC-UNIT (822-8648) www.vsirentalsllc.com.** (PBM)

## ROLL-OFF TRAILERS

1993 Galbreath AC416 single container roll off trailer. Bridge weight design, just sandblasted and painted with aluminum Budds. Good condition. \$14,000. KLM Companies. 617-909-9044. (P4)

## SEPTIC TRUCKS

1999 9200 series Int'l with 2004 300 fresh/3300 waste hoist tank full open door; Challenger 460 pump; Jetter: 3000 psi 11 gpm, Cat C-12 w/Jake, 10-spd.; 314,000 miles, good truck & tires, works everyday; \$46,000 OBO. 1-877-89BURNS. (P4)

2000 Sterling cabover 2000 waste/300 fresh w/Harben 4016 jetter w/Fruitland pump, 88,600 mi. 641-673-9377 or 641-660-6991. (P5)

1992 Kodiak, Cat diesel, auto trans., new IIT 2500 gal. alum. tank, hydro-driven NVE 360 Challenger pump, 19,000 miles, 2600 hrs. Asking \$65,000 OBO. Call 231-620-3228. More info & pictures @ www.waltsteuer.com. (P4)

Septic pumper, 1997 Balzer 1800 gallon tank on 1993 International 9300 tandem axle truck, w N14 Cummins, excellent rubber. Overall good condition. 2,3 and 4" hoses, 100 gallon fresh water. \$29,900. Ph 507-920-3959. (P4)

## SEPTIC TRUCKS

2001 Peterbilt 330, Cummins 300 hp, 120,000 miles, 10-spd. Eaton Fuller auto. trans., Masport H20W vacuum pump, 2500 gal. aluminum tank. \$40,000. 608-546-4400. (P4)

2001 Freightliner C120, cab & chassis with 3,750 US gallon, 2-compartment (250 water/3500 waste) aluminum tank, Challenger 367 pump, 6 gpm @ 3000 psi jetter. (Stock #0428C) **www.VacuumSalesInc.com, (888) VAC-UNIT (822-8648).** (PBM)

1991 International 4900, 466, diesel, 2200 gallon septic pumper. Works great. Retiring. \$21,000. Ph 502-352-9613. (P4)

1989 FORD LTL 9000, 425 CAT, 8LL trans, 4000 gallon 1995 Prime Industries tank, yr. 2000 Fruitland 500 pump. VERY GOOD CONDITION. Fresh rubber, ALL service records. \$35,000. 207-892-3070; libby003@roadrunner.com. (P4)

Five (5) 2003 to 2006 3200 US gallon **stainless steel** vacuum tanks. **www.VacuumSalesInc.com, (888) VAC-UNIT (822-8648).** (PBM)

1992 F800 with 2100 gal. tank, 197K, LP gas, Battioni pump, new brakes and paint. Great starter truck. \$14,900. Indiana. 765-914-7583. (P4)

1992 Mack RD690S, 300HP, 7 speed, 3500 gallon tank, Moro pump. \$21,000. 718-945-6262. (P4)

1984 Freightliner, Cummins, 4-axle, vacuum truck. Thompson pump, Thompson 3800 gal. tank. \$15,000 OBO. Jim 951-545-9604. (P5)

**CASH FOR YOUR CLUNKER VACUUM TRUCK.** We also buy used vacuum tanks 2000 gallon up to 5000 gallon. **CASH PAID.** Ph 903-794-9921 or 903-278-0026. (P5)

1990 F-800, 7.8 diesel, 6 cyl., 2500 gal., lift tank, large pump, runs and pumps good. Retiring. \$20,500. Ph 502-352-9613. (P4)

2010 Peterbilt 348s with new Presvac 3,600 US gallon aluminum vacuum pressure tanks with Masport HXL400WV vacuum pressure pumps. (Stock #8807 & 8808) **www.VacuumSalesInc.com, (888) VAC-UNIT (822-8648).** (PBM)

## SEPTIC TRUCKS

2007 New Juggler J10 pumper on 2007 Peterbilt 357 with 2006 pre-emissions Cummins ISM 380 hp. Fuller LL 10-spd. trans, 18k front, 46k rears, 12k pusher, 850 cfm NVE blower, heated valves and lines, pressure washer, hydraulic hose reel. Demo unit low hours and miles. \$299,750. Call Art B at 908-339-5216. (P5)

2010 Peterbilt 348 with a new Presvac 3,600 US gallon carbon steel vacuum pressure tank with a Masport HXL400WV vacuum pressure pump. (Stock #8806) **www.VacuumSalesInc.com, (888) VAC-UNIT (822-8648).** (PBM)

2004 Freightliner M-2, under CDL, 3126 Cat, 6-spd., AC, CC, clean, 191,000 miles with unused 1800 gal. vacuum tank, under CDL. \$30,000 OBO. Hamilton, MI. 616-218-3155. (P4)

1992 International 4900 7-speed, 2500 gallon tank with hydraulic lift and full open rear door. Masport liquid cooled pump. \$25,000. WI 920-585-9924. (CPBM)

CARGO 7000, 1987, 2300 gal. tank, needs O-rings in engine, and new vacuum pump. Drove like a Cadillac til the O-Rings went. \$8,000 OBO 608-387-0227. (P4)

2007 Intl. DT-466, 2300 gal. tank, \$65,000; 2008 Ford F-750, Cummins, automatic, 2300 gal. tank, \$67,500; 2001 Intl. DT-466, new 2300 gal. tank, \$37,500; 2004 GMC, C-7 Cat, 2300 gal. tank, \$42,500; 2001 Intl. DT-466, tandem, 3600 gal. tank, \$45,000. Lane's Vacuum Tank, 1-800-592-3308. Rodney Lane cell 270-832-3793. (PBM)

Need a tank and truck, any size, any make truck? Let us help you get the best deal. Custom built to your specs. For information and a price quote call 800-545-0174. www.tanksandpumps.com. (PBM)

2005 Peterbilt 357-C13 CAT, 190,000 miles, with a 2005 Keith Huber Dominator 4000 gallon tank with hoist, end dump and vibrator. \$85,000. 2000 Peterbilt 357-C12 CAT, 340,000 miles, with a 2008 Keith Huber Dominator 4000 gallon tank with hoist, end dump and vibrator. \$75,000. 941-429-6842. (P5)

## SERVICE/REPAIR

**Sewer Cam Reel, Camera and Locator Repair:** 48-hr. turn-around time. General Wire, Ratch, Ridgid, Pearpoint, Electric Eel, Gator Cams, Insight Vision, Vision Intruders. Quality service on all brands. For more info. give Jack a call. Dynamic Cable Repairs, Lodi, NJ 07644. 973-478-0893. (PBM)

## SLIDE-IN UNITS

New 500 gal. slide-in unit, 5.5 Honda electric start, 73 cfm Masport pump vac/pres. Financing available. Call for details. \$6,900. 785-231-0834. (P4)

## SLUDGE APPLICATORS

For Sale: 3500 gallon vacuum slurry tank with 4 shank injector. Good condition. Sold with or without pump. \$5,500 with, \$3,000 w/o or best offer. 517-425-0600. (P5)

1980's - 4000 gallon with injectors, Moro pump with 190 Cummins 5 speed trans. and 4 wheel drive. Loading and unloading done within cab. \$4,000. 412-403-4027. (P6)

2005 9105 TERRAGATOR APPLICATOR, LOW HOURS, EXCELLENT CONDITION, GREAT RUBBER. \$225,000 OBO. 815-743-5701 TOM MILLER. (P5)

## TANKS

Vacuum tanks, 100 to 6000 gallons. All options available; hatches, primary, secondary, valves, catwalks, ladders, etc. Everything needed to build your own septic truck. Choose mild, stainless, or galvanized steel. Ask about full open doors. 800-545-0174. www.tanksandpumps.com. (PBM)

**New 3400 gallon tank,** 20" manway bottom, 3" intake, 4" dump, hose trays, valves, painted. \$13,000. 4000 gallon and many other sizes available. Delivery available. 800-721-2774. (PBM)

VACUUM TANKS: 1600, 1800 & 2000 gallon, one of each. All have primary, manways, sight glasses, hose trays, frame rails. Never used, never mounted. \$5,500 and up. Hamilton, MI. 616-218-3155. (P4)

## TANKS

Five (5) 2003 to 2006 3200 US gallon **stainless steel** vacuum tanks. **www.VacuumSalesInc.com, (888) VAC-UNIT (822-8648).** (PBM)

Presvac 2,800 US gallon aluminum tank only. (Stock #7959C) **www.VacuumSalesInc.com, (888) VAC-UNIT (822-8648).** (PBM)

## TANK TRAILER

1998 V. E. Enterprise Frac Tank Trailer, #FC500, in very good condition. Reasonable offer accepted. Vermont. 802-948-2082. (P4)

NEW Presvac 5500 gallon c/s DOT certified vacuum tank trailer unit, with a PV750 pump, Deutz diesel. (Stock #13373) **www.VacuumSalesInc.com, (888) VAC-UNIT (822-8648).** (PBM)

## TOOLS

**Crust Busters** - Portable, lightweight machine guaranteed to mix up septic tanks and grease traps! Save time and money! **www.crustbusters.com, 1-888-878-2296.** (PBM)

**T&T Tools:** Probes, Hooks. Probes feature steel shafts with threaded and hardened tips. The insulated **Mighty Probe™** tested to 50,000 volts. **Top Poppers™** open manhole covers easily. Free catalog. **www.TandTtools.com.** Phone **800-521-6893.** (CPBM)

## TOYS

Septic pumper and vacuum die-cast toy trucks in your choice of colors and logos. Several cabs available. Call 877-450-2100, write to Granite State Collectibles, PO Box 440, New Ipswich, NH 03071; or **www.granitestatecollectibles.com.** (PBM)

## TRUCKS MISCELLANEOUS

1984 Autocar Conventional tractor, 511,000 miles, 3406 DI 400 Cat, 13 speed transmission, tag axle. \$30,000. Call JD at 775-825-1595, email [jd@watersvacuum.com](mailto:jd@watersvacuum.com). (P4)

## TRAILERS VACUUM/TANKER

Cusco MASTERVAC BAGHOUSE Filter Trailer. Attach to turbo vacuum tanker for "dry vacuum" applications. Single 8" cyclonic baghouse assembly 42" diameter with 29-4" diameter x 59" long polyester acrylic coated bags, air cannon pulsation system with timer control, side swing-out bottom cleanout, 4" brass drain valve, aluminum cam-lock fitting, swing up top access cover with hydraulic lift cylinder and hold down clamp, 6" piping and inlet port for connection to vacuum truck. Call 810-789-7155. (P4)

Advertise in Classifieds for only **\$1.00 PER WORD!** at **www.pumper.com**

## TRAILERS VACUUM/TANKER

88 Brenner 5,000, 316 gallon stainless, DOT cert. vacuum trailer. New Moro vac pump with hyd. drive, stainless subframe, new tank inspections/brakes/tires. KLM Companies, 617-909-9044. (P4)

## TV INSPECTION

CUES Hi-Cube Van Video Inspection Unit on 2006 Chevy E-450 diesel chassis (14,050 GVWR) w/auto transmission and 14' load-space. 6000W, 120V, 60Hz generator w/onboard control room, Pipeline data collection & real time video capture system. (2) 17" LCD flat screens, 1,500' multi conductor kevlar fiber cable, (1) electric motor drive TV cable reel, (1) self-propelled camera. Excellent condition. **Reduced sale price of \$95,000.** Contact Marvin Kelly @ 772-201-2086 for sale details or Mike Parker 772-216-4020 for technical details. (PBM)

1995 Chevy Van with **8100 original miles**, RST video system, Omni Eye II color camera, transporter, RST data display plus system with VCR and 19" monitor. Was municipal owned and in like new condition. 714-639-8352. **www.empireequip.com.** (CPBM)

2002 Ford E-450 Cube Van, V-10, 57,500 miles, Onan generator, Omni III Camera pan/tilt with zoom, dual monitor, POSM software. \$60,000. Call JD at 775-825-1595 or [jd@watersvacuum.com](mailto:jd@watersvacuum.com) for photos. (P4)

## VACUUM LOADERS

2005 Volvo Gap Vax HG57, wet/dry, 5,300 cfm 27" blower with full open rear door and offloading pump. Clean truck. KLM Companies 617-909-9044. (P4)

1999 International **heavy spec** with **Guzzler ace** wet/dry industrial vacuum loader. 8" top load boom truck is in excellent condition! (Stock #7390V) **www.VacuumSalesInc.com, (888) VAC-UNIT (822-8648).** (PBM)

1999 Kenworth with Presvac Powervac 3,800 CFM 27" blower with 3,500 gal. tank. DOT certified unit with full open rear door and Presvac vacuum offloading pump. KLM Companies 617-909-9044. (P4)

1994 International 4700 with a 2003 Keith Huber 1100 US gallon waste, 400 US gallon water, 2-compartment, carbon steel vacuum tank with a Masport H 7.5 V vacuum pump. (Stock #6499C) **www.VacuumSalesInc.com, (888) VAC-UNIT (822-8648).** (PBM)

"Take \$15,000 off!" Hard to find TST Liquid Ring Vac Truck! 2005 Freightliner w/only 160K miles! Cat 7 engine; full ACME coded 3500 gal. tank w/2300 psi jetter; must see to appreciate! Only \$144,999. 865-805-4662. (P4)

## VANES

Dura Comp 535, high-quality non asbestos vacuum pump vanes. Good to 400°F. Buy factory direct and save. Same day shipment on most models. Jurop, Battioni, Moro, Masport, Fruitland, Demag. Long lasting Dura-Comp 535 pump vanes carry a "Money-back" guarantee. Call us today. Powerflo Products 800-758-4788 or 562-997-0720. (PBM)

American Industrial Components: Our vanes are manufactured from the highest quality laminated materials available and are fabricated to exact tolerances and specifications. 800-272-7557. (PBM)

## WANTED

WANTED!! CASH PAID!! For used vacuum tanks 2000 to 5000 gallon. No junk. Also buy used vacuum pumps and vacuum tanker trailers. Ph 903-278-0026 or 903-794-9921. (P5)

WANTED PORTABLE TOILETS: Used regular and handicapped units. Good condition. Phone 616-754-8939. (P4)

WANTED: Looking for USED PORTABLE TOILETS. Must be GRAY, well maintained and available for shipping or pick up now. Call Rick 207-884-8358 or 207-735-4317. (P4)

Wanted to Buy: Vactor 2100s and late model Guzzlers. Cash. Phone 800-336-4369. (CPBM)

## WATERBLASTING

Water jetting equipment. We rent, sell and repair water blasters. Visit us at: [www.waterjettingequipment.com](http://www.waterjettingequipment.com) or phone 714-259-7700. (PBM)

2004 NLB 40-150 electric, 40,000 psi waterblaster, (0) hours on unit - never used. Marathon Motor on skid with control panel. KLM Companies, 617-909-9044. (P4)

**Gardner Denver** TF-375H w/ Cummins 15K @ 17GPM. **Gardner Denver** T-450M w/Series 40 Detroit 10K @ 39GPM. **Jetstream** 4215 w/Cummins 10K @ 39GPM. **Gardner Denver** TX-450SB w/V12-71 Detroit 10K @ 70GPM. **Gardner Denver** T-450 w/ Jetstream fluid end transmission 10K @ 40GPM. **T-450** w/ 8.2L GM 20K @ 14GPM. **TF-450** Series 40 Detroit 20K @ 20GPM. **T-300** w/Jetstream fluid end bareshaft pump 10K @ 14GPM. **THE-500UH** 50K bareshaft pump. **NLB** 10-600 Cummins 10K @ 104GPM. **Reliable RD-100** John Deere 10K @ 10GPM. **Frontier Pump** 8K PSI @ 17GPM Detroit 3-53. **Wheatley 125** Detroit 10K @ 20GPM. **Wheatley 165** 10K @ 30GPM. Bareshaft pumps are available. Boatman Ind. 713-641-6006. View @ [www.boatmanind.com](http://www.boatmanind.com). (CPBM)

Classifieds Category List :: Pumper Magazine

<http://www.pumper.com/classifieds/>

WWW.ONSITEINSTALLER.COM | WWW.PROMONTHLY.COM | WWW.CLEANER.COM | WWW.NGMAG.COM | WWW.PUMPERTRADER.COM | WWW.PUMPERSHOW.COM

**Pumper** SUBSCRIBE EDITORIAL CLASSIFIEDS VIDEO ADVERTISE

Looking to BUY or SELL?  
Just Submit Your Classified Ad ONLINE!

**It's Easy & Secure!**

**Only \$1.00 PER WORD (\$20 Min.)**

Your ad will be posted on the **Pumper** Web site within two to three business days after received.

Just go to [www.pumper.com](http://www.pumper.com); click on "Classifieds;" click on "Place a Classified Ad;" fill in the online form.

IF YOU ARE USING AN

**800 NUMBER**

IN YOUR AD, BE SURE IT CAN BE USED IN ALL AREAS NATIONWIDE.

PLACE YOUR AD ONLINE AT [www.pumper.com](http://www.pumper.com) - IT'S ALWAYS THERE TO MEET YOUR BUSY SCHEDULE





**Get Results!**

Advertise in **CLASSIFIEDS** for only

**\$1.00** per word!  
(\$20 min.)

**MUNICIPAL  
SEWER  
&  
WATER**

**Cleaner Pumper**

**CLASSIFIED AD FORM**

**PRO**

**ONSITE  
installer**

Please print ad legibly below with *correct punctuation* and *phone number*. Circle each word to be bolded, if any. (\$1.00 extra per word)

\_\_\_\_\_  
\_\_\_\_\_  
\_\_\_\_\_

**CHOOSE THE CATEGORY:**

- |  |   |   |  |   |   |
|--|---|---|--|---|---|
| <input type="checkbox"/> Aerators                    | <input type="checkbox"/> Dredges                | <input type="checkbox"/> Levels & Transits        | <input type="checkbox"/> Positions Wanted    | <input type="checkbox"/> Root Control             | <input type="checkbox"/> Trailers- Vacuum/Tanker    |
| <input type="checkbox"/> Blowers                     | <input type="checkbox"/> Excavating Attachments | <input type="checkbox"/> Locators                 | <input type="checkbox"/> Pressure Washers    | <input type="checkbox"/> Safety Equipment         | <input type="checkbox"/> Trucks (dump/septic/misc.) |
| <input type="checkbox"/> Bucket Machines             | <input type="checkbox"/> Excavating Equipment   | <input type="checkbox"/> Miscellaneous            | <input type="checkbox"/> Pumps-Dredge        | <input type="checkbox"/> Septic System Components | <input type="checkbox"/> TV Inspection              |
| <input type="checkbox"/> Businesses                  | <input type="checkbox"/> Hand Tools             | <input type="checkbox"/> Parts & Components       | <input type="checkbox"/> Pumps-High Pressure | <input type="checkbox"/> Septic Tanks             | <input type="checkbox"/> Vacuum Loaders             |
| <input type="checkbox"/> Business Opportunities      | <input type="checkbox"/> Hazardous Waste Units  | <input type="checkbox"/> Pipeline Rehabilitation  | <input type="checkbox"/> Pumps-Submersible   | <input type="checkbox"/> Septic Trucks            | <input type="checkbox"/> Vanes                      |
| <input type="checkbox"/> Cable Machines              | <input type="checkbox"/> Hydroexcavation        | <input type="checkbox"/> Portable Toilets         | <input type="checkbox"/> Pumps-Vacuum        | <input type="checkbox"/> Service/Repair           | <input type="checkbox"/> Vehicle Tracking           |
| <input type="checkbox"/> Computer Software           | <input type="checkbox"/> Jetters-Trailer        | <input type="checkbox"/> Portable Toilet Tanks    | <input type="checkbox"/> Pumps - Washdown    | <input type="checkbox"/> Slide-In Units           | <input type="checkbox"/> Wanted                     |
| <input type="checkbox"/> Dewatering                  | <input type="checkbox"/> Jetters-Truck          | <input type="checkbox"/> Portable Toilet Trailers | <input type="checkbox"/> Pumps-Water         | <input type="checkbox"/> Sludge Applicators       | <input type="checkbox"/> Wastewater Transfer        |
| <input type="checkbox"/> Drainfield Restoration      | <input type="checkbox"/> Jet Vacs               | <input type="checkbox"/> Portable Toilet Trucks   | <input type="checkbox"/> Rodding Machines    | <input type="checkbox"/> Tanks                    | <input type="checkbox"/> Waterblasting              |
| <input type="checkbox"/> Drain/Sewer Cleaning Equip. | <input type="checkbox"/> Lease Financing        | <input type="checkbox"/> Positions Available      | <input type="checkbox"/> Roll-Off Containers | <input type="checkbox"/> Tools                    |   |

**CHOOSE THE PUBLICATION(S):** (Deadlines are for the month preceding issue)

- |   |   |  |
|---|---|--|
| <input type="checkbox"/> <b>CLEANER</b><br>Deadline: 1st of the Month                     | <input type="checkbox"/> <b>PUMPER</b><br>Deadline: 10th of the Month           | <input type="checkbox"/> <b>PRO</b><br>Deadline: 17th of the Month |
| <input type="checkbox"/> <b>MUNICIPAL SEWER &amp; WATER</b><br>Deadline: 1st of the Month | <input type="checkbox"/> <b>ONSITE INSTALLER</b><br>Deadline: 17th of the Month |  |

**CLASSIFIED AD RATE:**

\$1.00 per word, per month, with a 20-word minimum or \$20.  
[\$1.00 extra per bold word (key words only)]

**ADVANCE PAYMENT REQUIRED:**

No billing for classified ads. Payment must be received in advance before publishing.

**CALCULATE THE AMOUNT DUE:**

\_\_\_\_\_ words X \$1.00 = \_\_\_\_\_ X \_\_\_\_\_ Publications X \_\_\_\_\_ Months = \$ \_\_\_\_\_  
(\$20 minimum) # of publications checked above # of months to run the ad Total Amount Due

(Example: 25-wd. ad x \$1.00 per word = \$25.00;  
\$25.00 x 2 publications [Pumper & Pro] = \$50.00;  
\$50.00 x 2 months to run the ad = \$100.00 Total)

**FILL IN COMPANY AND PAYMENT INFO:**

COMPANY NAME: \_\_\_\_\_  
 ADDRESS: \_\_\_\_\_ PHONE: \_\_\_\_\_  
 CITY: \_\_\_\_\_ STATE: \_\_\_\_\_ ZIP: \_\_\_\_\_

**MAIL** this completed form with payment to:  
COLE Publishing Inc., PO Box 220, Three Lakes, WI 54562

**FAX** this completed form to: **715-546-3786**

**ONLINE** forms at: [www.cleaner.com](http://www.cleaner.com)  
[www.pumper.com](http://www.pumper.com)  
[www.promonthly.com](http://www.promonthly.com)  
[www.onsiteinstaller.com](http://www.onsiteinstaller.com)  
[www.mswmag.com](http://www.mswmag.com)

**QUESTIONS: CALL 1-800-257-7222**

PLEASE FILL OUT CREDIT CARD INFORMATION COMPLETELY INCLUDING V-CODE (3-DIGIT NUMBER FOUND BY YOUR SIGNATURE)

CREDIT CARD NO.: \_\_\_\_\_ V-CODE: \_\_\_\_\_ EXP. DATE: \_\_\_\_\_  
 CARDHOLDER NAME: \_\_\_\_\_ PHONE: \_\_\_\_\_



# POLYLOK™ Inc.

Innovations in Precast, Drainage & Wastewater Products



Zabel®  
A Division of Polylok Inc.

## U.V. DISINFECTION UNIT

The reliability and performance of the PL-UV1 is unmatched for onsite and decentralized treatment applications. Every component of the compact unit is highly engineered and constructed to provide reliable disinfection and superior operational life.



## NEW PUMP LINE & AIR PUMPS

Polylok has taken on a new pump line to bring you quality pumps at competitive prices. Polylok now offers air pumps for your residential and light commercial sewage aeration applications.



## INSULATED COVERS

Polylok's  
New Products for  
**2010**

**1.800.701.3942**

For a free catalog or to see other products call or visit our website: [www.polylok.com](http://www.polylok.com)

## ACTIVATED CARBON VENTED COVERS

Polylok's Activated Carbon Vented Covers are heavy duty and designed to eliminate offensive odors caused by your septic system. Available in 18", 20" & 24" to fit Polylok risers & corrugated pipe.



## POLY-AIR™

The Poly-Air™ is an activated carbon roof vent manufactured to easily fit your existing pipe. Available to fit pipe sizes: 4", 3", 2" & 1.5"



## DECORATIVE LANDSCAPE STONES

With our decorative landscape stones not only do you achieve incredibly realistic aesthetics, but unmatched longevity in virtually any climate. Polylok offers a wide variety of sizes to fit your needs.

## 18" & 24" HEAVY DUTY COVERS AND GRATES FOR CORRUGATED PIPE

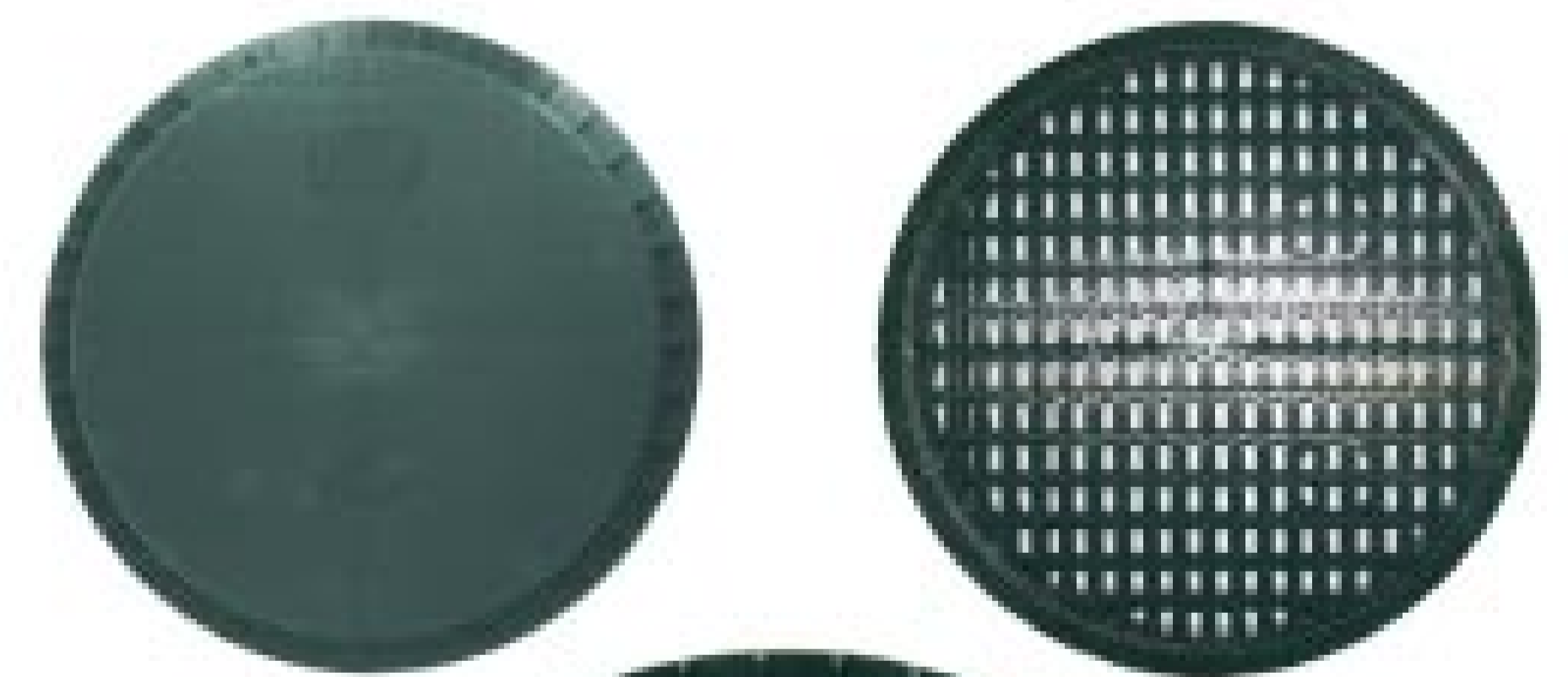

## LOW PROFILE FILTER & BASIN





# 2010 Pumper Show SPECIALS

**EXTENDED  
THRU APRIL 30TH!**



### FREE ADA-Compliant SaniStand™ Foam with Purchase of Two Comfort Inn Units

Meet the special needs of all your customers with the Comfort Inn wheelchair accessible unit and the ADA-Compliant SaniStand Foam.

*Offer expires 4/30/10. Valid for U.S. customers only. Must present coupon at time of order to redeem.*

800.292.1305 • www.polyjohn.com



### Buy a Waterworks™ Fresh Water Delivery System and Get One FREE Case of Lily Tabs (60 Gram)

With the WaterWorks Portable Self-Contained Freshwater Delivery System, an electrical pump delivers fresh water on-demand to office trailers, showers, and more!

*Offer expires 4/30/10. Valid for U.S. customers only. Must present coupon at time of order to redeem.*

800.292.1305 • www.polyjohn.com



### Buy Six 250- or 300-Gallon Holding Tanks and Get One FREE

Buy bulk waste storage in bulk and save! Holding tanks provide versatile storage options on job sites – ours are slim enough to even fit under office trailers.

*Offer expires 4/30/10. Valid for U.S. customers only. Must present coupon at time of order to redeem.*

800.292.1305 • www.polyjohn.com



### FREE SaniStand™! Buy Two Full-Flushing Fleet™ Units and Get a SaniStand (Standard Foam or Towelette) FREE

VIP events require VIP service! Provide high-end customers the comfort of a full-flushing Fleet unit and the sanitizing benefits of a SaniStand Foam or SaniStand Towelette.

*Offer expires 4/30/10. Valid for U.S. customers only. Must present coupon at time of order to redeem.*

800.292.1305 • www.polyjohn.com



### Buy One, Get One FREE! Buy One SaniStand™ (Standard Foam or Towelette) Get One FREE

Keep hands clean even when water is not available! The SaniStand's antiseptic foam or moist towelettes kill more than 99% of germs on hands, including E. coli and salmonella.

*Offer expires 4/30/10. Valid for U.S. customers only. Must present coupon at time of order to redeem.*

800.292.1305 • www.polyjohn.com



### FREE GIFT! Two Bottles of Fresh Sink Sanitizing Tabs Free with Purchase of Bravo!® Sink

The Bravo! Sink sets the industry standard high – it's the only polyethylene sink that offers a warm-water wash. Keep your sinks fresh and germ-free with our exclusive FreshSink Sanitizing Tablets.

*Offer expires 4/30/10. Valid for U.S. customers only. Must present coupon at time of order to redeem.*

800.292.1305 • www.polyjohn.com



### Buy 25 Cases of University Toilet Paper and Get One Case of Scent Saver Discs FREE

University Roll Toilet Paper offers 2.5 more paper than standard rolls. With that much paper, you'll go out to service less. Slip a Scent Saver onto your toilet paper rod to keep your restrooms smelling fresh until your next service!

*Offer expires 4/30/10. Valid for U.S. customers only. Must present coupon at time of order to redeem.*

800.292.1305 • www.polyjohn.com



**There when you need us!**  
**Were you not able to attend the Pumper show? You can still take advantage of our terrific show specials!**

800.292.1305 | www.polyjohn.com

# **PRESVAC**

DESIGNED AND BUILT FOR PERFORMANCE

## **Bright Finish Aluminum Tanks**

for the Septic Pumping Industry...  
Standard tank models from  
2,000 gallons to 5,000 gallons.



## **Hydro-Trencher**

5300 CFM air flow/28" HG vacuum with 8" hydraulic actuated boom, 3000 U.S. gal. stainless debris tank, 1000 U.S. gal. stainless water tank, 9 G.P.M. water pump with pressures to 5800 p.s.i.

## **Powervac 5300 for Wet/Dry Operation**

5300 CFM air flow/28" HG vacuum,  
Dump chutes extended to rear of truck,  
Stainless steel 316, DOT 407/412



## **Liquid Truck - DOT 407/412**

Designed for industrial liquid applications

# **PRESVAC**

4131 Morris Drive  
Burlington, Ontario, Canada L7L 5L5  
Fax: 905-681-0411

Nationwide Sales & Service  
**905-637-2353 • 800-387-7763**  
[www.presvac.com](http://www.presvac.com)