

BIG & BRAVNY: Choose Your Next Classy Chassis

DEDICATED TO THE LIQUID WASTE INDUSTRY

Pumper®

October 2008 www.pumper.com \$5.00 U.S.

IN GOOD HANDS

Orderly transfer of ownership helps
Arizona family keep on pumping

PAGE 28

PAIN at the PUMP

Where will diesel prices
be heading in two years?

PAGE 38

COLE PUBLISHING INC.
1720 MAPLE LAKE DAM RD.
PO BOX 220
THREE LAKES WI 54562

CHANGE SERVICE REQUESTED

PRSTD STD
U.S. POSTAGE
PAID
PERMIT NO. 411
Beaver Dam, WI



POWER PLUS PERSONALITY

WE BUILD TRUCKS THAT TAKE CARE OF BUSINESS AND GET YOU NOTICED



Referrals are the best way to get business, but don't forget a great looking truck is one of the best ways to advertise your business. Let Satellite build your next restroom or septic truck and plan on turning a few heads.

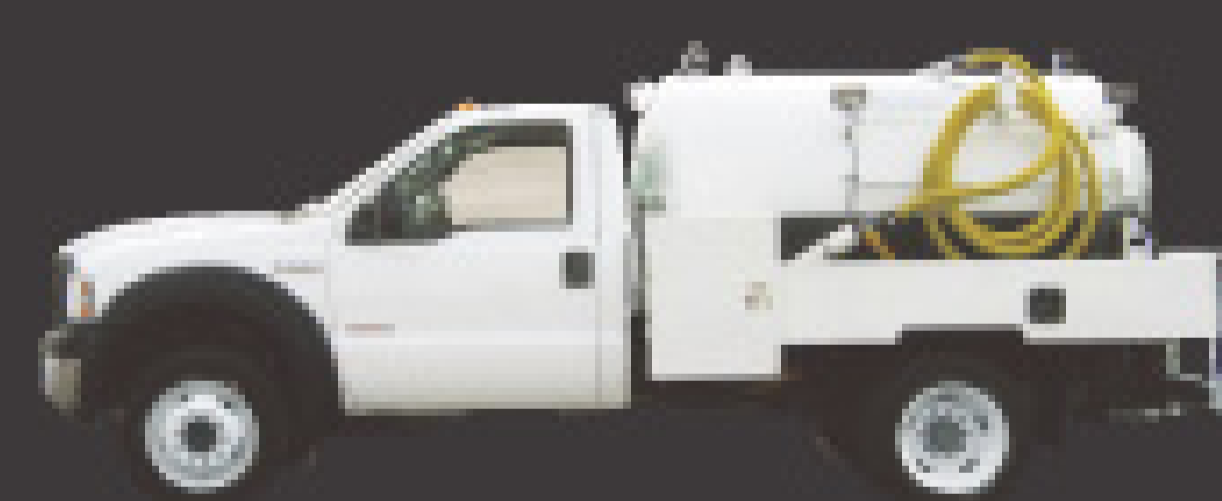

950 STARTING AT \$54,793



1250 STARTING AT \$65,743



1600 STARTING AT \$70,993



800 STARTING AT \$68,595



2500 PETERBILT \$85,965



3600 PETERBILT \$109,653

WWW.SATELLITEINDUSTRIES.COM



Imagine The Possibilities

800-328-3332

Masport®

We have the Pumps you Trust, in a System you can Rely On.

HXL400WV
400 CFM



Durable. Reliable. Powerful.

- Engineered for Fast Load Times & Optimum Recovery
- Liquid Cooled for Higher Continuous Vacuum
- Liquid Stabilized to Eliminate Freeze-ups in Winter Months Ahead

Fast and Convenient

- Pre-Assembled
- Quick and Easy to Install
- Includes Components to Protect your Pump

HXL400WV
Plug & Play System

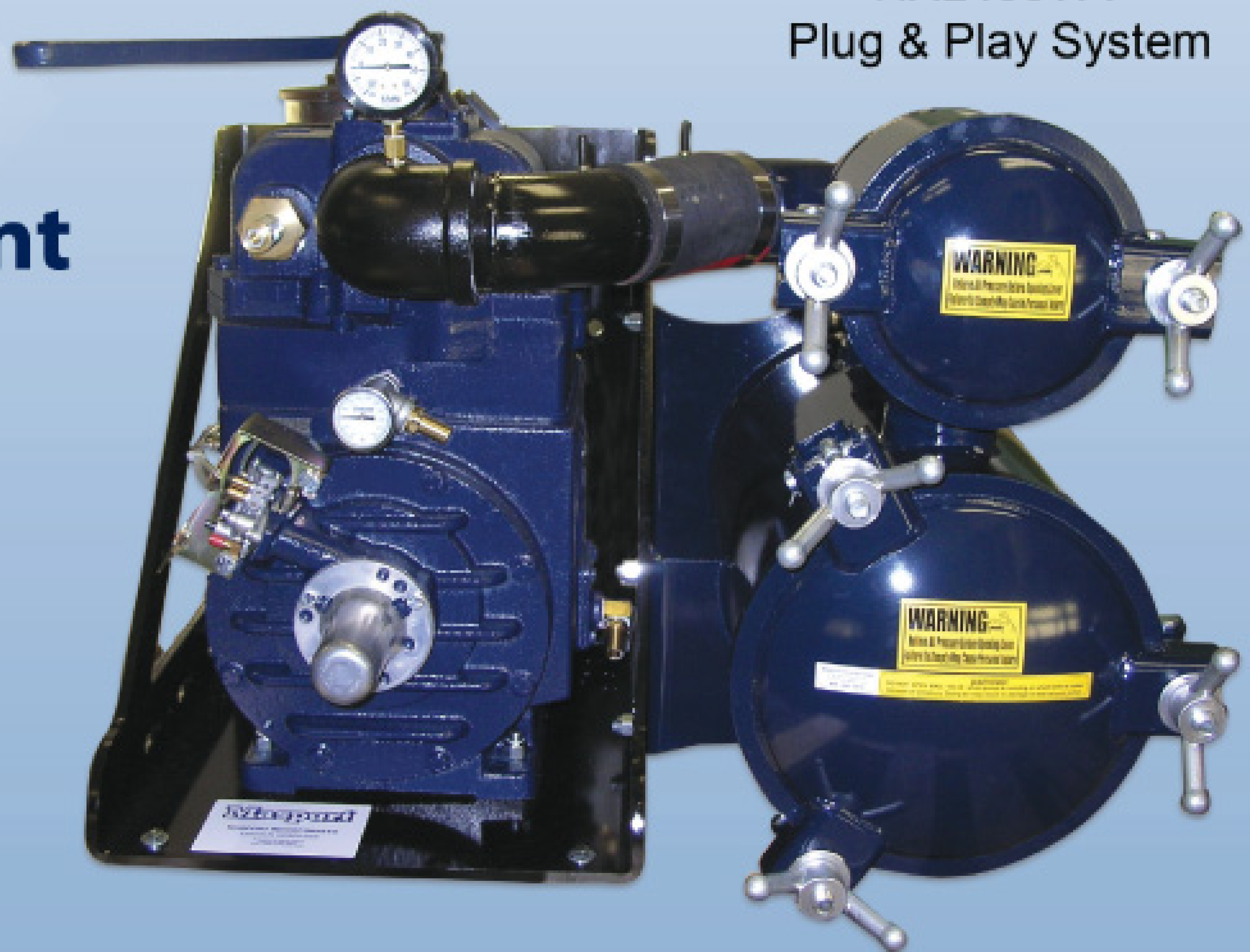

Clockwise & counter-clockwise rotations available.

For more information call toll free 1(800)228-4510
Visit us online at www.masportpump.com

Enjoy a Harvest of Interesting Stories



By Jim Kneiszel, Editor

Like so many leaves falling to the ground through much of the U.S. this month, this issue of *Pumper* is blanketed with colorful and unique characters from the liquid waste industry. And as the autumn season marks a slowing in the hectic routine for many pumping professionals, we offer new editorial content to help you gear up for a successful start to 2009.

NEW SET OF WHEELS, ANYONE?

Are you contemplating a new service rig for next year? With a somewhat stagnant economy this year and many contractors holding off to see how new emissions systems were working out for 2008, there may be a pent-up demand for new septic haulers in '09. So we decided to check out the latest chassis that make up the foundation for larger vacuum trucks. In our feature ("Big & Brawny"), product news editor Ed Wodalski creates a side-by-side spec sheet for the latest trucks built to handle tanks of 2,000 gallons and up. Along with a list of information most critical to pumpers in the market for a new truck, we include Web links showing you where to get more details directly from manufacturers.

WHAT'S UP WITH DIESEL?

We had a simple question for writer Greg Northcutt: Why is diesel fuel more expensive than gasoline? Historically, diesel is often less expensive than the more highly refined gasoline we put in most of our pickup trucks and cars. In his extensive report ("Pain at the Pump"), Northcutt gives us the answer, and so much more information on the diesel refining process, a world perspective on growing demand for fuel and an expert forecast on where fuel prices will be heading in the next year or two.

FATHER KNOWS BEST

When Steve Ziegler, owner of Old Pueblo Septic and Drain Service Inc., watched his children, Scott and Amy, grow up, he had one rule about them working for the family business. They had to work for someone else first. So when Scott and Amy joined Old Pueblo after college and time in at other companies, the pair came home to the pumping company as well-rounded workers who appreciated the opportunity. Learn more about this proud pumping family in writer Ken Wysococky's contractor profile story, "In Good Hands."

PUMPERS JUST WANT TO HAVE FUN

This summer, Keith and Carol Coddington, former owners of Pennsylvania's K and C Septic Services, took their first vacation together in 36 years. After they retired, the couple took a long-awaited trip out west, and then came home, where Carol settled into enjoying her favorite pastime, gardening. In an installment of our new feature, *After Hours* ("A Growing Hobby"), writer Judy Kneiszel shares the master gardener's tips for appropriate ground cover over the septic system.

And speaking of having a little fun, we called Minot, N.D., to check in with pumper Sandon "Dude" Varty, co-owner of Evans Septic Tank Service. In our *In the News* feature, we learn that Sandon's brother, Dallas, was featured in a local television news version of the popular reality TV series, *Dirtiest Jobs*. Dallas had fun showing a reporter the proper way to clean RV holding tanks at the North Dakota State Fair. ■

Contact us: *Pumper* strives to serve the liquid waste industry with interesting and helpful stories. We welcome your comments, questions and column suggestions and promise a prompt reply to all reader contacts. Call 800/257-7222; fax 715/546-3786; e-mail *Pumper* editor Jim Kneiszel at editor@pumper.com.

Sanitation Station
"Commercial Quality" Running Water Restroom

No out of pocket expense
Immediate revenue generation
New product to your rental fleet without a major investment

Three business model offers with the Sanitation Station are:

OPTION 1
• You buy it!
• You rent it!
• You pump it!

OPTION 2
• You have a six month minimum rental...
• We rent the unit to you at a discounted rental rate...
• You mark the unit up and re-rent it to your customer...
• You enjoy the revenue from pumping the unit...

OPTION 3
• You have a six month minimum rental...
• Call DropBox and we land the business for you...
• We rent the unit to your customer...
• You enjoy the revenue from pumping the unit...

DROP BOX
1.888.388.7768
www.dropboxinc.com

Lenzyme
Solutions for all Waste & Grease Problems

WHY GREEN MEANS MORE GREEN

BEST PACKAGING - BEST PRODUCTS - BEST PRICE

Discover Marketing Secrets to More Pump-Outs
1-800-223-3083
Call Today for Your **FREE** Sample

ROOTX

Trap-Cleer **Lenzyme**

HOUSE OF IMPORTS **TRUCK SALES**

▶▶ SINCE 1947

CALL ANGEL AT:
786.258.3384
OR
305.691.4778

▶▶ WWW.HOUSE-OF-IMPORTS.COM

\$90 DOWN, \$90 PER MONTH 'TIL 2009*

*WITH APPROVED CREDIT



2004 PETERBILT 379
4000 GAL. TANK - THANKS TO RICHARD



2001 PETERBILT 379
THANKS TO JASON GORMOND



2005 MACK VISION
5000 GALLONS - THANKS TO MR. CLINTON



2000 INTERNATIONAL
THANKS TO MARK SMITH

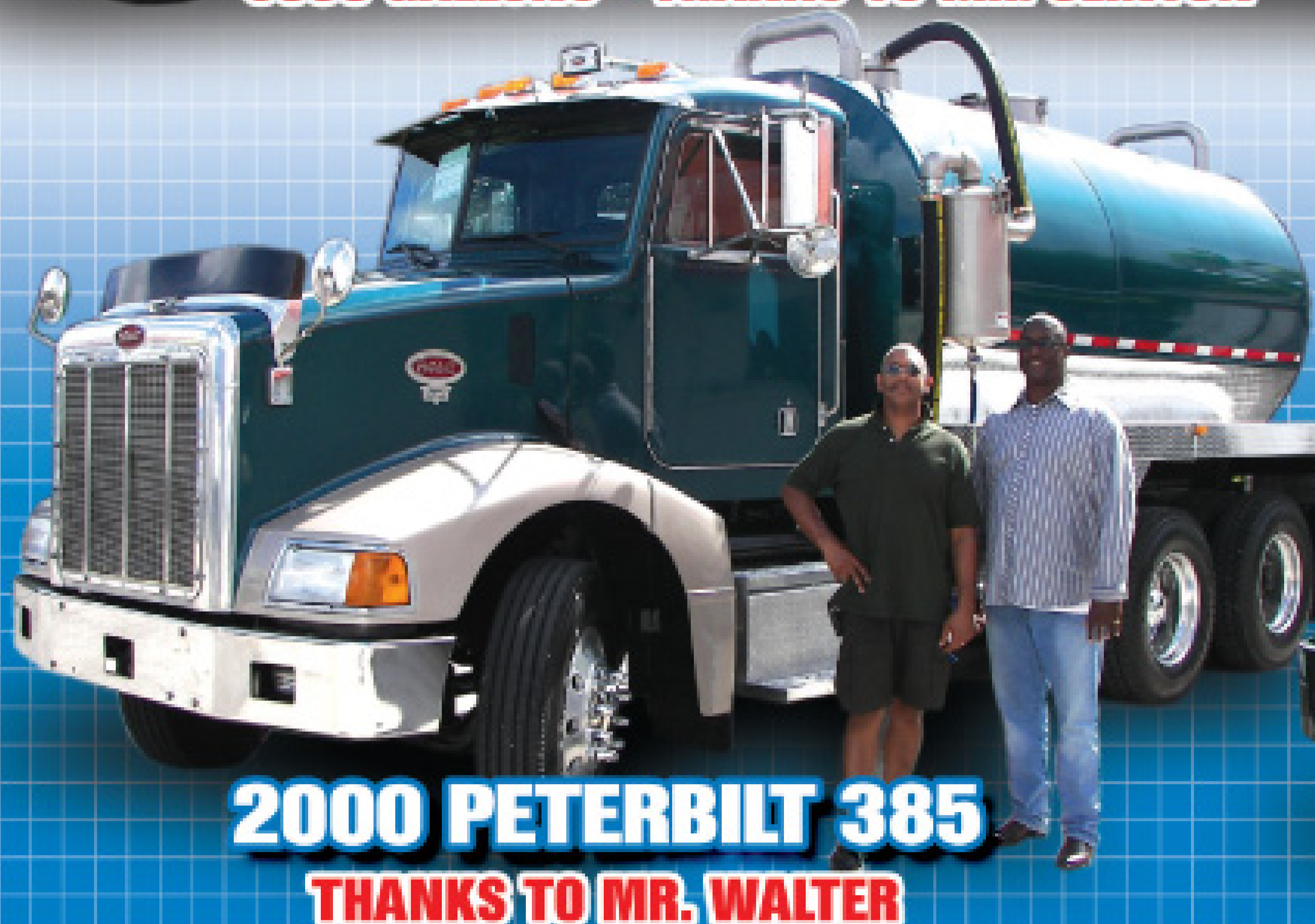

2000 PETERBILT 385
THANKS TO MR. WALTER



2006 PETERBILT 365
3600 GAL. DUMP, FULL LOCKERS REAR

100,000 MILE LIMITED FACTORY WARRANTY

▶ DELIVERY ▶ EXPORT ▶ PUMP WARRANTY: 1 YEAR ▶ TANK WARRANTY: 5 YEARS

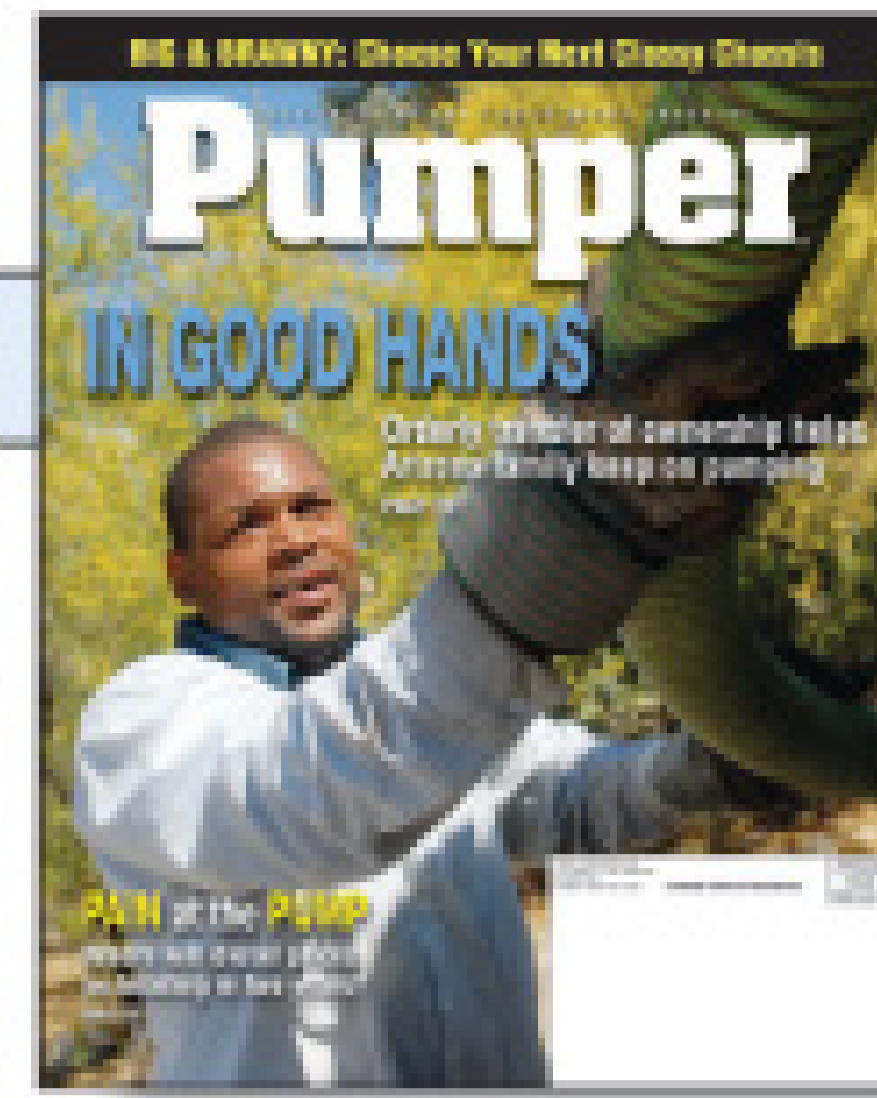

ARTICLES

28
In Good Hands
- Ken Wysocky

On the cover: Valuable life lessons and understanding of the business resulted in an orderly family ownership transition for Old Pueblo Septic and Drain Services. On the cover, Old Pueblo service technician Zep Holmes is shown replacing a vacuum hose after a pumping job. (Photo by Jeffrey Scott)

4
**Reading Between the Lines:
Enjoy a Harvest of Interesting Stories**
- Jim Kneiszel

10
**Building the Business:
Expect a Run on Gold Watches**

The coming years will bring a record number of employee retirements. Make sure you're prepared for the exodus of baby boomers.
- Anne Houlihan

18
**Rules and Regs:
Virginia Adds Mandatory Maintenance
and Onsite System Evaluator and
Designer Credentials**
- Scottie Dayton and Doug Day

38
SPECIAL REPORT: Pain at the Pump
Supply and demand issues have turned fuel prices upside down in recent months as traditionally economical diesel has trumped gasoline.
- Greg Northcutt

48
**TRUCK CHASSIS ROUNDUP:
Big & Brawny**
We offer a by-the-numbers peek at the latest chassis choices for septic hauling rigs.
- Ed Wodalski

56
In the News: A Dirty Job ...
But the pumpers at Evans Septic Tank Service show they're proud to serve the North Dakota State Fair.
- Jim Kneiszel

64
After Hours: A Growing Hobby
Central Pennsylvania gardener and retired pumper Carol Coddington shares septic tank knowledge with other flower enthusiasts.
- Judy Kneiszel

76
Overheard Online: Endless Billing
The tank has been pumped. The bill has been sent. A poster wonders what to do when a customer refuses to pay.

REGULAR FEATURES

70
**Money Manager:
Be a Miser With Expenses, a Hog With Savings**
Follow this common sense approach to running your business and do a better job of weathering the next recession.
- Patrick Astre

82
**Reader Pipelines:
Mind Your Lugnuts**
Picking the right truck for the job and maintaining it carefully will keep a pumper's job going smoothly.
- Mary Shafer

90
**Septic System Answer Man:
Proper Venting Eliminates Odors**
When customers complain about a whiff of rotten eggs caused by the septic system, a quick fix usually takes care of the problem.
- Roger E. Machmeier, Ph.D

98
**NAWT News:
Take Charge — Become a Responsible
Management Entity**
- Tom Ferrero

104
**Product News:
Spotlight —
Pacific Natural Energy Corp. Bio-Box**
- Ken Wysocky

112
**Association News; Training and Education;
Calendar**

122
Industry News

144
Classy Truck of the Month
Advantage Septic & Drain, Upsala, Minn.

Coming in November

**Special Issue:
Septic System Maintenance and Rejuvenation**

- Pipelines: Repair, rejuvenate or replace?
- Overheard Online: Signs of a failing tank

Pumper.

DEDICATED TO THE LIQUID WASTE INDUSTRY

www.pumper.com

Published monthly by
COLE Publishing Inc.
1720 Maple Lake Dam Rd.
PO Box 220
Three Lakes WI 54562

© Copyright 2008 COLE Publishing Inc.
No part may be reproduced without
permission of the publisher

In U.S. or Canada call toll-free 800-257-7222
Elsewhere call 715-546-3346
E-mail: info@pumper.com
Web site: <http://www.pumper.com>
Fax: 715-546-3786

Office hours 7:30 a.m. - 5:00 p.m.
Central Time, Monday - Friday

SUBSCRIPTION INFORMATION: A one year (12 issue) subscription to *Pumper* in the contiguous 48 U.S. states costs \$16 (24 issues for \$26; 36 issues for \$36). Subscriptions to Canada or Mexico cost \$28 per year (24 issues for \$54). Subscriptions to all other foreign countries cost \$82 per year. Subscribers are guaranteed monthly delivery of the magazine. To subscribe, send company name, mailing address, phone number and check or money order (U.S. funds payable to COLE Publishing Inc.) to the address above. MasterCard, VISA and Discover are also accepted. Supply credit card information with your subscription order.

CLASSIFIED ADVERTISING: RATE: \$1.00 per word, per month. Minimum of 20 words or \$20. All classified advertising must be PAID IN ADVANCE. **DEADLINE:** Classifieds must be received by the first of the month for insertion in the next month's edition. **PHONE-IN ADS ARE NOT ACCEPTED.** Ads may be faxed only when charging to MasterCard, VISA or Discover. Please supply all credit card information with faxed ads. Be sure to include your phone number (with area code) in your ad. Make checks payable to COLE Publishing Inc. and mail with classified ad to the address above. **CLASSIFIED ADVERTISING APPEARS NATIONWIDE AND ON THE INTERNET.** Not responsible for errors beyond first insertion.

DISPLAY ADVERTISING: Call 800-994-7990 and ask for Jeff, Jim, Kim, Winnie or Phil. Publisher reserves the right to reject advertising, which in its opinion is misleading, unfair or incompatible with the character of the publication.

CIRCULATION: Circulation averages 24,493 copies per month. This figure includes all three circulation regions (nationwide) and international distribution.

2009 PUMPER & CLEANER ENVIRONMENTAL EXPO INTERNATIONAL



Education Day:
February 25, 2009

Exhibits Open:
February 26-28, 2009

Kentucky Exposition Center
Louisville, Kentucky
www.pumpershow.com



moroPUMPS

"Over 50 years of service and here to stay!"

Ask for a quality Moro pump from your truck builder, or call us for the dealer nearest you.

Pittsburgh, PA . 1-800-383-6304 . fax 412-269-4172 . www.morousaeast.com . moroeast@attglobal.net
St. Louis, MO . 1-866-383-6304, 636.584.8844 . fax 636-583-2044 . www.morousaeast.com . moro@charter.net

Isn't it time to UPGRADE to a MORO?

Complete Right Angle Packages

Completely Assembled

Pumps available from 176-1642 cfm

M3
176 cfm



M10
230 cfm



PM80 350 cfm

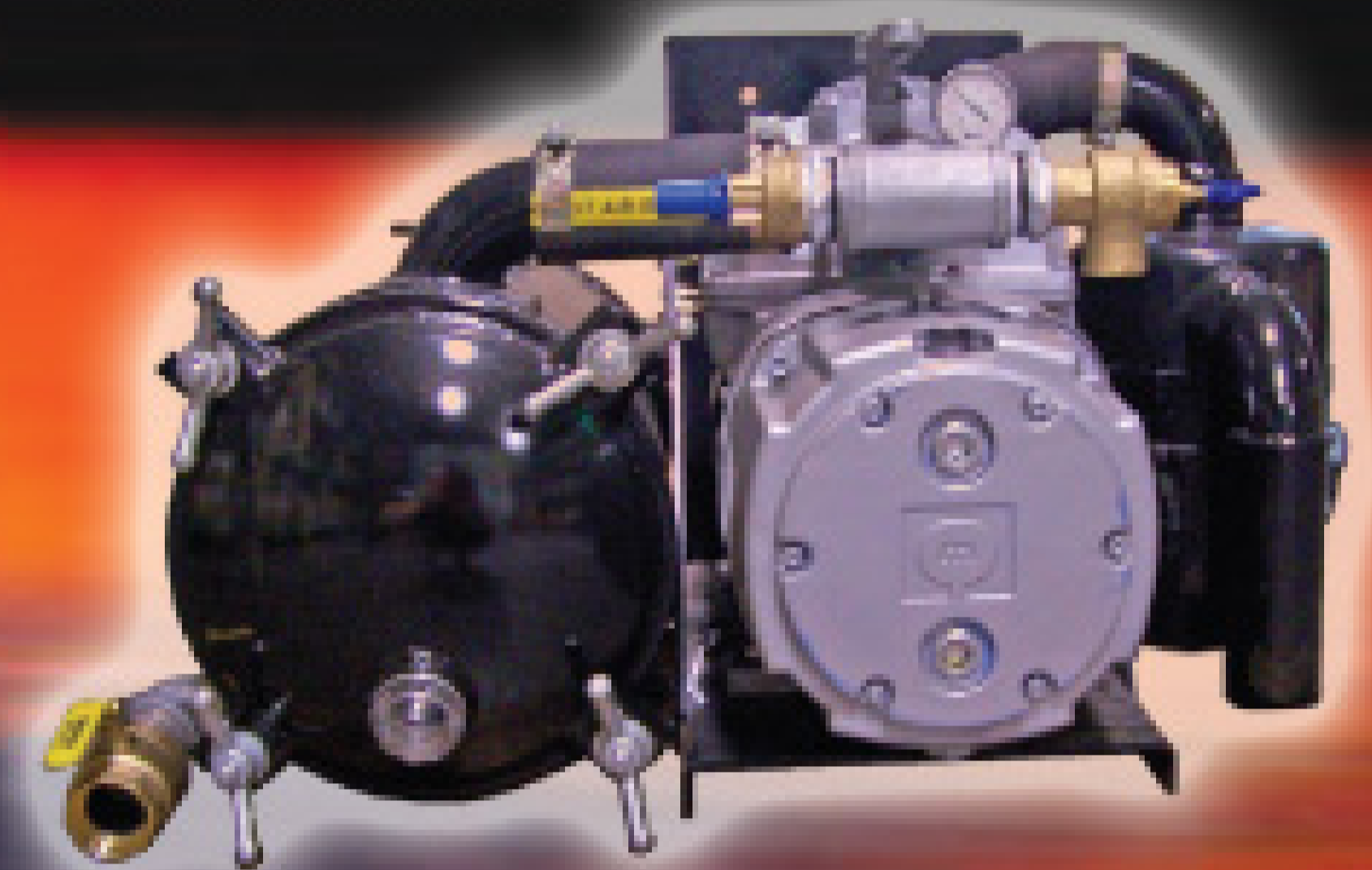

PM100
460 cfm

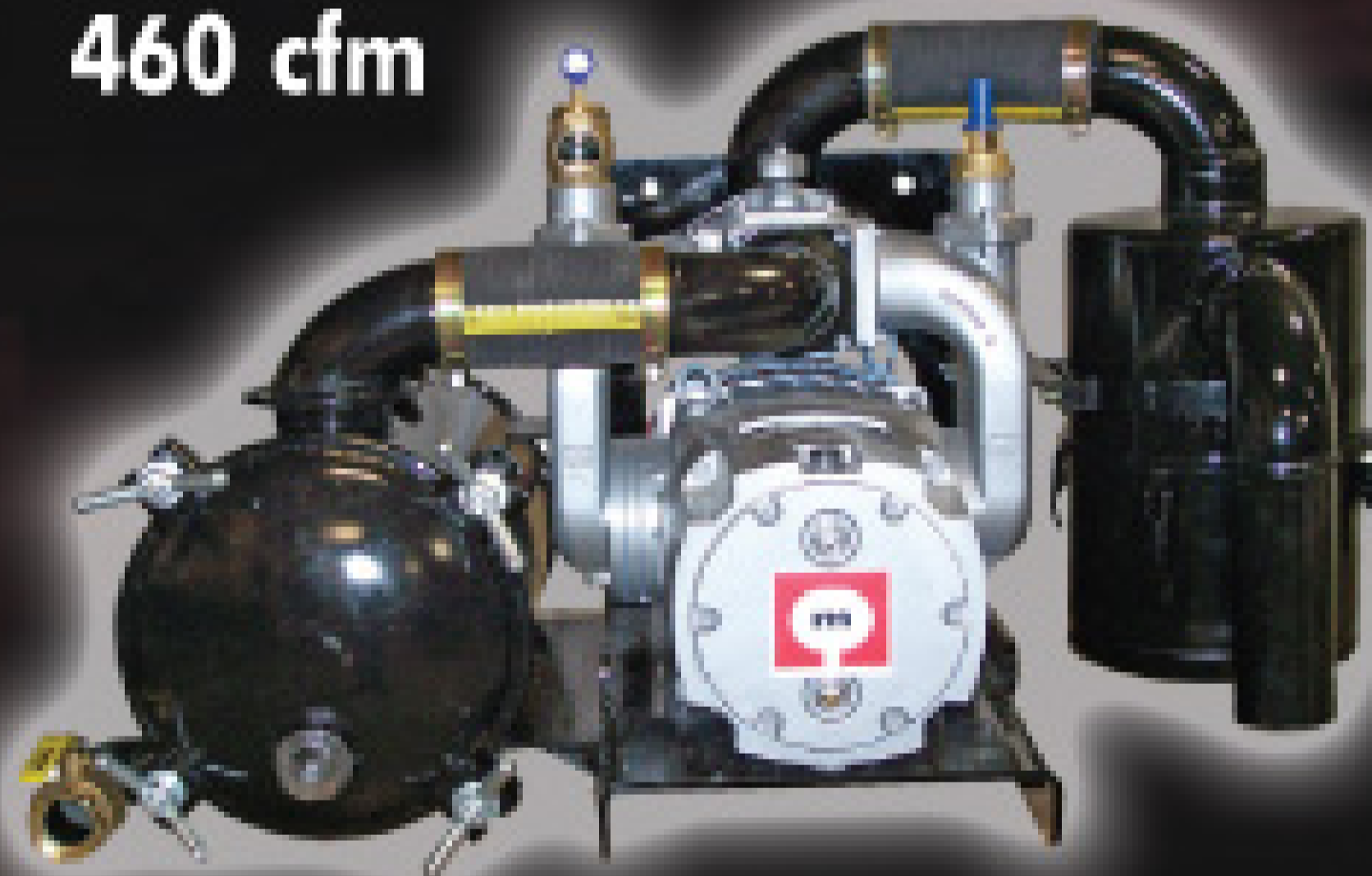

RIGHT ANGLE, HYDRAULIC,
GAS OR DIESEL PKGS.
AVAILABLE
ON ALL PUMPS

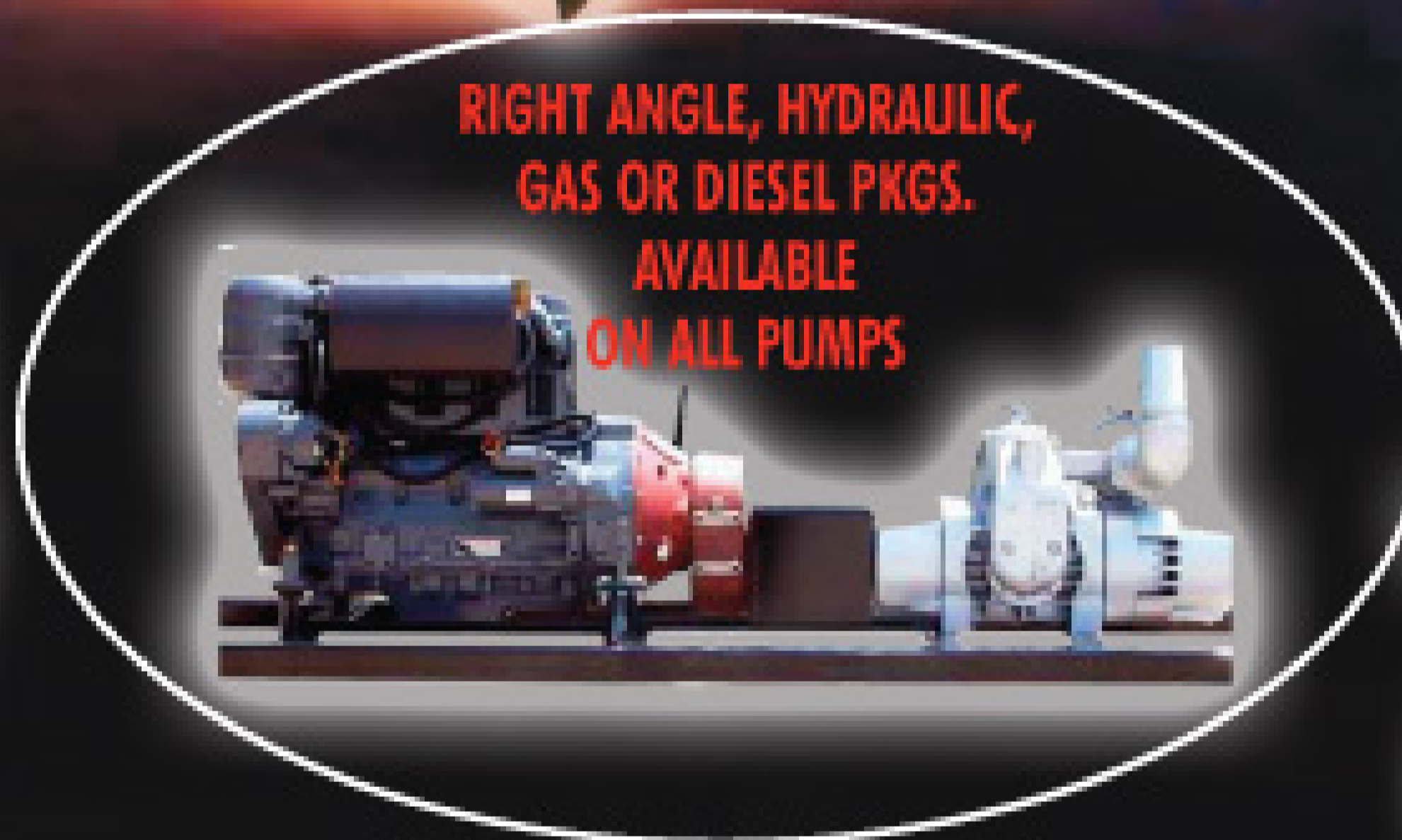

PM2600 824 cfm

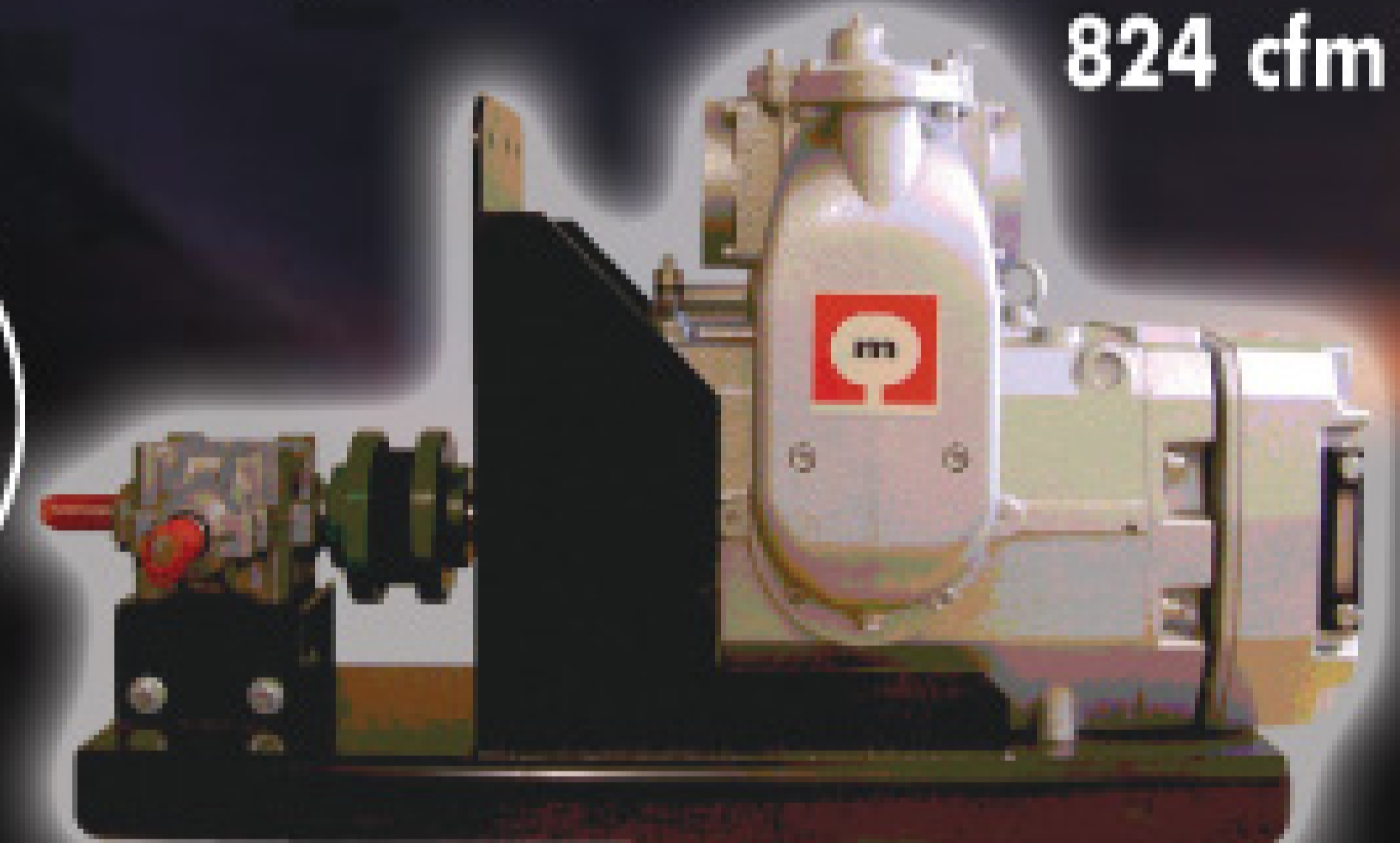

DC-STAINLESS Washdown Pump

NO COMPARISON



NO more
RUSTY
water!

OUTPERFORMS
the Burk's
cast iron
DC-10!

NO More
FROZEN
pump!



316 Stainless Steel Mounting
Brackets, Pump Head & Impeller

Quality RIV Components In Stock — Ready for Shipment



ACCU-LEVEL

Accurate Tank Volume Measurement

No Balls • No Tubes • No Floats • No Worry!
No Internal Tank Components

Get paid for what you pump!

Only pay for what you dump!



Level Indicator

Factory calibrated, the general purpose indicator reads 0-100% of volume in gallons. A single push button allows users to scroll through their active channels.



Pick-up Unit

The general purpose two-wire transmitter provides non-contact level measurement up to 32' and is ideally suited for challenging corrosive, coating or waste liquids.

ADVERTISER index

October 2008

27th Trucks, Inc.23

A



Abbott Rubber Co., Inc.20



Abernethy Welding & Repair ..111
Acro Trailer Company123



Advance Pump & Equip.107
Advanced Tank Systems62
Aero-Stream LLC.....109
Alpha Mobile Solutions129
AlturnaMats68
American Machine & Tool Co. 110
Amigo Truck Ltd.....57
Amthor International94
Anchor Graphics114
Aqua Ben Corp.122
Aqua Blast Corp.100



Aqua-Zyme Disposal Sys.86
Aquaworx55



Arcan Enterprises Inc.66



ARMAL Inc.91



Armstrong Equip.13, 78, 140
Art's Truck & Equipment145
Atlanta Rubber & Hyd.92

B

Badger Vacuum Trucks118
Baker's Waste Equipment88
Balzer Inc.130
Bandlock Corp.94
BDP Industries Inc.19
Best Enterprises, Inc.27
Big Fish Environmental44
Black Tie Mfg. Inc.125
Brenlin Co. Inc./Seal-R124



Bright Technologies145

C

Cadman Power Equipment. ..125



Cam Spray58
Cape Cod Biochemical.....52
Capital Partners LLC128

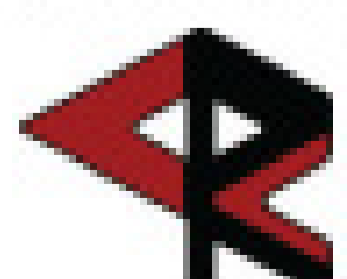

Capital Rubber Corp.110

Center Capital Corp.103
Centrisys124



Chandler Equipment Inc.9, 11
Chempace Corporation127
Circle D Truck Sales100



Clear Computing Inc.123
Com Vac Systems84



Comforts of Home34
Consolidated Pipe & Tube80



Crust Busters/Schmitz Bros. 130
Custom Tank & Equipment44

D

Del Vel Chemical Co.128
Denver Truck Sales128
Dragon Products36-37
Drayner Products Inc.68
Drop Box Inc.4
Dunham & Morrow Inc.78

E

Ecological Laboratories145



Elastec/American Marine88
Engine & Accessory Inc.65
Erickson Tank & Pump21
Excel Equip. & Supply129

F



F. S. Solutions108
Fergus Power Pump Inc.18
Five Peaks Technology96



Flo Trend Inc.129
Fritz Industries17
Frontier Technology24
Fruitland Tool & Mfg.32

G

GapVax Inc.77
Glendale Welding96
Global Vacuum Systems Inc. 93
GO FOR DIGGER66
Granite Leasing Co.47
Green Way by PolyPortables ..85

H

Hampel Corp.101
Hannay Reels22
House of Imports5
Hull's Truck Bodies122

I

Imperial Industries Inc.87

J



J&J Chemical Co.63



JAG Mobile Solutions60
James Wilbee Company Inc. ..22

K

KeeVac Industries Inc.61
Kentucky Tank Inc.92
Key Commercial Corp.118
Kiscan LLC16
KMH Equipment Inc.116
Kroy Industries66

L

L.C. Tanks53
L.M.T. Inc.120
Labrie Environmental Group ..58
Lane's Vacuum Tank Inc.78



Lely Manufacturing Inc.80
Lely Waste Solutions68



Lenzyme-Trap-Cleer Inc.4
Longhorn Tank & Trailer Inc. ..31

M



Marsh Industrial124



Masport Inc.3
Max-Life Mfg.52
McKee Technologies Inc.122
Michigan Vacuum Truck Inc. 116
Mid-Continent Truck Sales ..131
Mid-State Tank Co. Inc.127
Milwaukee Rubber Prod.12



Moro USA East Inc.7
MTH Pumps16
Mytana Mfg. Co. Inc.20

N

National Truck Center102
National Vacuum Equip.25
NOWRA79
NozzTeq™ Inc.34



NuConcepts32

P

Pat's Pump & Blower80



Pik Rite, Inc.62
PolyJohn Enterprises147

Polylok Inc.146
PolyPortables Inc.14-15
Power Vac Inc.52
PowerFlo Products Inc.46
Precision Tank & Equip.54

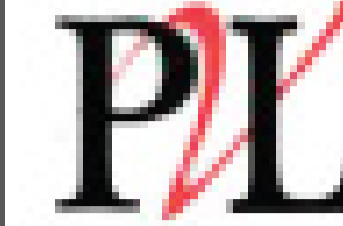

Pressure Lift Corp.44
Presvac Systems Ltd.148
Prime Solution Inc.32
Pro-Sept Protection Plan58



Prototek12

R

R.A. Ross N.E.106
Reelcraft Industries Inc.60
Rich Mobile Restrooms12

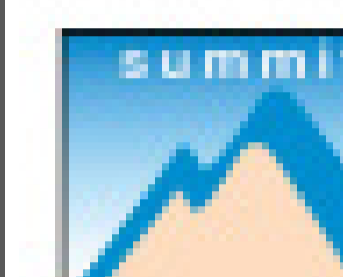

Ritam Technologies LP60
Robinson Septic Service125
RotoSolutions Inc.100
RouteOptix Inc.108
Rush Refuse Systems33

S

Safety Pumping Systems86
Satellite Industries2, 74-75
Semo Tank130



Septic Services Inc.54
Simple Solutions102
Simpson/Delco24
Sludge Mgmt. & Reuse102
Smithco Mfg. Inc.46
Specialty B Sales120
Stellar Industries Inc.26
Super Products LLC26
Superior Signal Co.127
Surco Products95
Sweet Septic Systems Inc. ..106

T

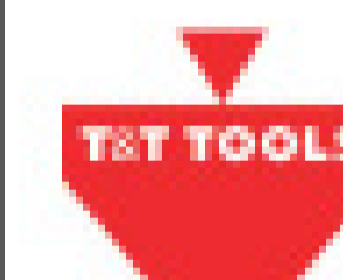

T&T Tools Inc.16
Tank Truck Service & Sales ..140



TankTec45
The Service Program127



Toico Industries Inc.89



Transport Truck Sales35



Transway Systems Inc.99
TRS Industries12

Truck Town Inc.118
Truck Works Inc.42
TSF Company Inc.83
TST, LLC115
Tuf-Tite Inc.43

V

V.E. Enterprises Inc.41
Vac-Con, Inc.121
Vacutrux Limited110



Vacuum Sales Inc.24, 126



VAR Co.81

W

Walex Products Co.117
Wallenstein Pumps-Elmira34
Wastequip Cuco Inc.97
Water Cannon69
Wee Engineer Inc.67



Wells Cargo COG42
West-Mark Inc.126
Westmoor Ltd.59
White River Distributors123
Wilcox Truck Sales108
Wolf Creek Co., Inc.106

X

Xenon Pictures119

Z

Zoeller Pump Company71

Classifieds132
Marketplace138
Truck Stop141

REGIONAL ADVERTISERS Midwest Supplement

(after page 66)

Allied Tank3
Bosserman Tank & Truck8
Engle Fabrication LLC4
Liberty Financial3
Marengo Fabricated7
Mid-State Truck Service4
Milwaukee Rubber6
Pierson Co.3
Rider Vacuum Sales1
T-Line Equipment Inc.5
V&H Inc.5

Eastern Supplement

(after page 66)

Allied Tank2
Andert Inc.4
Bay State Truck8
Bosserman Tank & Truck8
Cellofoam4
Liberty Financial2
Manchester Hose5
Marengo Fabricated7
Southcoast Equipment3
TSI Tank Services1, 6
V&H Inc.5

NEW
LC300
CONTENDER

300
CFM



JUROP **VACUUM** **PUMPS**

CONTINUOUS DUTY
PUMPS MADE FOR
EVERY APPLICATION

R260
VACUUM PUMP

363
CFM



Jurop

NORTH AMERICA

by



Ask About
Bolt-N-Go
Units



LC420
CONTENDER

424
CFM



Call 800-342-0887
for a dealer near you

www.chandlerequipment.com

Expect a Run on Gold Watches

The coming years will bring a record number of employee retirements. Make sure you're prepared for the exodus of baby boomers.

By Anne Houlihan

In 2011, the oldest baby boomers will turn 65, marking a turning point in the American workforce. As they begin to retire, the United States will experience the most dramatic economic and demographic changes in its history.

For the first time ever we are facing a mass retirement movement. To survive unscathed, companies — including pumping and portable sanitation businesses — must begin planning and preparation for this transition today.

At first glance, the impending baby boomer exodus may seem of little concern to you. After all, valued workers have been retiring from the workplace for ages. However, companies need to keep in mind that the upcoming retirement years are going to be larger scale than in any other time in our country's history.

With 76 million baby boomers leaving the workforce and only 46 million next-tier Generation X'ers (born 1963 to 1981) available to take the vacant positions, there's a deficit of 30 million workers. And while the youngest workers in your shop, known as the Millennials or Generation Y (born 1981-1999) number approximately 100 million, the oldest of them are too young and inexperienced to step into leadership roles.

Think about your own company for a moment. How will you handle this transition? How are you going to transfer the 40-plus years of wisdom and experience from the boomers to younger workers? How do you plan to keep your company successful and running smoothly with a deficit of workers?

The bottom line is that all companies need to harness young leadership already in place so the baby boomer exodus has as little impact as possible on the organization. Use the following tips to help make the transition period a smooth one:

Know what you're up against

Find out as soon as possible how this mass retirement will affect your company. Take a look at the ages of your employees. How many baby boomers are currently working in the company, what are their positions, and what are their anticipated retirement dates? For example, is your manager set to retire in the next five years? Will three key driver/technicians leave all at once?

Develop a knowledge transfer strategy

Forward-thinking companies have written job descriptions and requirements for every position. This is a start to the process of training younger workers to step up into more important roles. But it's not enough. There are subtleties of every job — things you do just because experience and knowledge points you in a certain direction. You simply can't document those kinds of things. That's why you need to go a step further and develop a strategy and training system for transferring the knowledge and skills of the older workers to their successors.

Team older and younger workers

As part of the knowledge transfer strategy, companies need to imple-

Anne Houlihan is the founder of Elevated Leadership International, where she works with companies to improve management. She can be reached through the Web site, www.ElevatedLeadership.com or by phone at 951/235-5405.



Your older workers may be open to staying onboard on a part-time basis or as a consultant. The more flexibility you offer, the more likely they'll be to stick around as a resource for the company. Be open to creative work arrangements if you want to retain your most experienced staff.

ment an ongoing mentoring program. For a company to have a successful transition, the younger generation needs to work side-by-side with the older workers for some time. Training younger workers to diagnose the issues surrounding a malfunctioning septic system, for instance, doesn't happen overnight. Think about the skills your older drivers have amassed over the years seeing so many different situations while on the job.

So if you know that a key person is going to be retiring in three years, have that person start sharing service routes with a younger worker right now. This is not something you can do during a new hire's 90-day training period. True mentoring takes at least a year to make any meaningful headway in passing on all that critical knowledge.

Starting now will help in employee retention with the younger workers as well. Generation X workers who receive this sort of long-term mentoring will feel more valued and realize they can play an important long-term role in your company moving forward.

Retain the older workers in some fashion

Realize workers might not want to retire completely on their 65th birthday. Many of your older workers will want to stay on in some capacity, either by choice or by necessity. Since many boomers are often working to put kids through school and taking care of aging parents at the same time, they may still want or need to work past 65. Some older workers just feel too good to retire.

In either case, your older workers may be open to staying onboard on a part-time basis or as a consultant. Since they often want to pursue other interests at this stage of their life, being chained down to a regimented full-time job won't appeal to them. The more flexibility you offer, the more likely they'll be to stick around as a resource for the company. Be open to creative work arrangements if you want to retain your most experienced staff.

MEET THE CHALLENGE

Because the unemployment rate is high right now due to a lagging economy, companies can draw from a better pool of workers to help fill the gap the boomers will be leaving. You may be able to take advantage of a stronger field of applicants right now to replace retiring workers. But when the economy rebounds, the hiring situation might be different.

The coming years will definitely be a challenge for companies, as more people will be retiring than usual. By helping everyone — young and older — work together, your company can be successful and thrive in the years to come. ■

Surprised?



We are just a bit more over.



METALTECNICA s.r.l.

www.metaltecnicazanolo.com



Chandler
Equipment, Inc.

Toll Free 1-800-342-0887
www.chandlerequipment.com

USA DISTRIBUTORS

Commercial Restroom Trailers



Choose from standard floor plans from 8' to 30' in length. Or customize a floorplan to meet your needs.

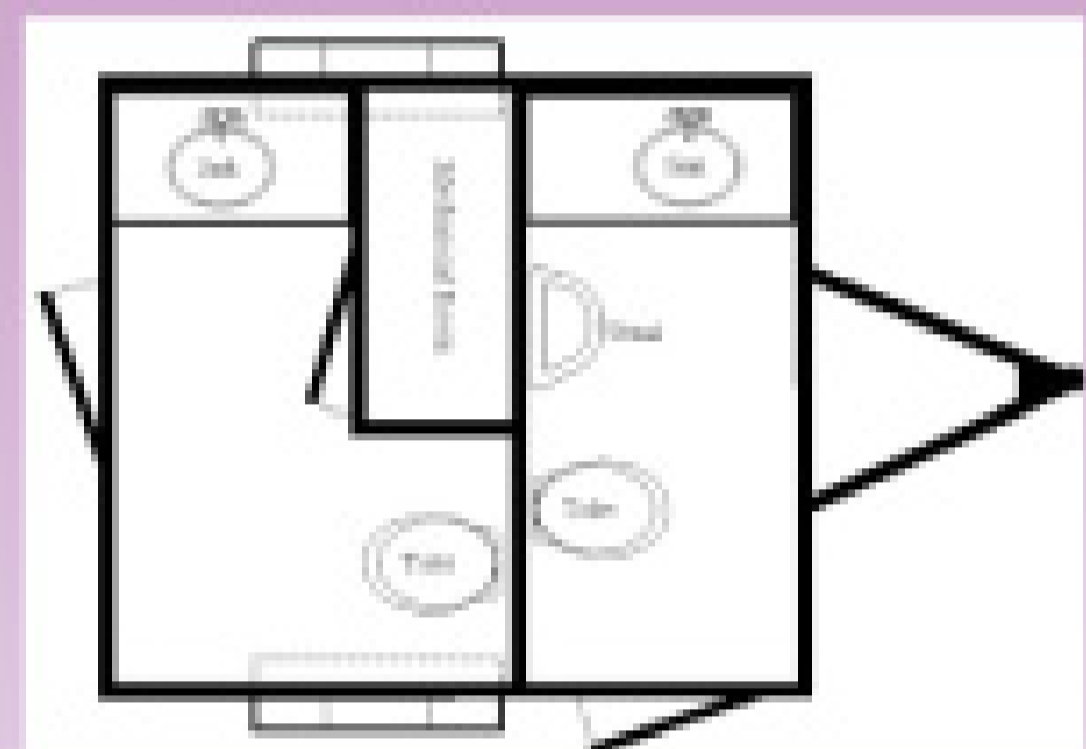
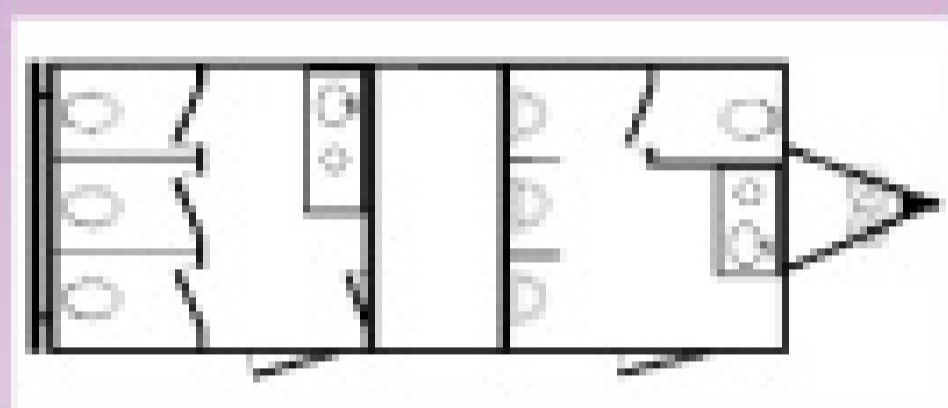

Rich Mobile Restrooms

www.RichRestrooms.com
260-593-2279 • Topeka, Indiana

Aluminum Vacuum Tank Trucks Septic & Restroom Service

Ask about 'Factory Direct' IN STOCK Units.

3800 Gallon (2) Compartment Septic Tank

Masport HXL400 water cooled
Jetter system with reel
2008 International 4400
Auto transmission

\$112,500

Plus F.E.T.

Lease from **\$1,943 mo.**



2008 Kenworth T300 - 22,000 GVW

Cummins diesel, auto. trans., Hydraulic brakes, AC, AM/FM.

1700 Gallon 400 fresh / 1300 waste

Masport HXL 4, Burks wash down,
Hot shift PTO 4" Discharge,
Unit hauler and tow package.

\$77,555

Lease from **\$1,135 mo.**



TRS INDUSTRIES, INC.
www.trstruck.com

Contact: Stan Eacobellis

Toll-free: 877-741-6936

Direct: 760-741-6936 Fax: 760-746-6767
651 West 5th Ave., Escondido, CA 92025



3,700 HAPPY PUMPER.

WHETHER YOU ARE AN OLD PRO OR JUST GETTING STARTED,

you can rely on Prototek for the best flushable transmitter and receiver systems in the industry. **FLUSH AND FIND** Locate underground nonmetallic tanks and lines with our orange AT-12 flushable transmitter and AR-1 receiver. ■ Team it with our Orange BuzzBox to trace underground metallic lines or utilities. ■ Locate in cast iron or nonmetallic lines with our blue FT-8 flushable transmitter and FR-1 receiver.

■ ■ Recycle your used AT-12s or FT-8s back to us for credit toward your next purchase.



FR-1 "FERRIS"
DELUXE KIT
\$785

ORANGE
BUZZBOX
\$435

AR-1 "ARDY"
DELUXE KIT
\$610

Prototek  **800-541-9123**

ECONOMICAL • EASY www.prototek.net email: prototeksales@prototek.net

Kanaflex® 220RS Rubber All-Weather Suction Hose SUPER FLEXIBLE IN COLD WEATHER

Call for Low Prices on 100' Lengths & Coupled Hose Assemblies

A revolutionary new method of manufacturing rubber suction and discharge hose has drastically reduced costs to hose users. The new process, ten years in development, utilizes Kanaflex SBR TYPE "T" POLYMER to give the lightweight, rubber hose outstanding flexibility and long life.

New Series 220 rubber suction and discharge hose has excellent dimensional stability and is easy to couple. Manufactured in six sizes from 1-1/2" through 6", the hose is available in 100' lengths. I.D. and O.D. are smooth. Temperature range is -40° F to 160° F – ideal for industry and construction job site use.

Distributors of: Dunlop • Goodyear • Kanaflex • Plastiflex
Hi-Vac & Other Hose • P-T & Evertite Quickcouplers
Dixon & Le-Hi Couplings • Hose Clamps • Banding Equip.

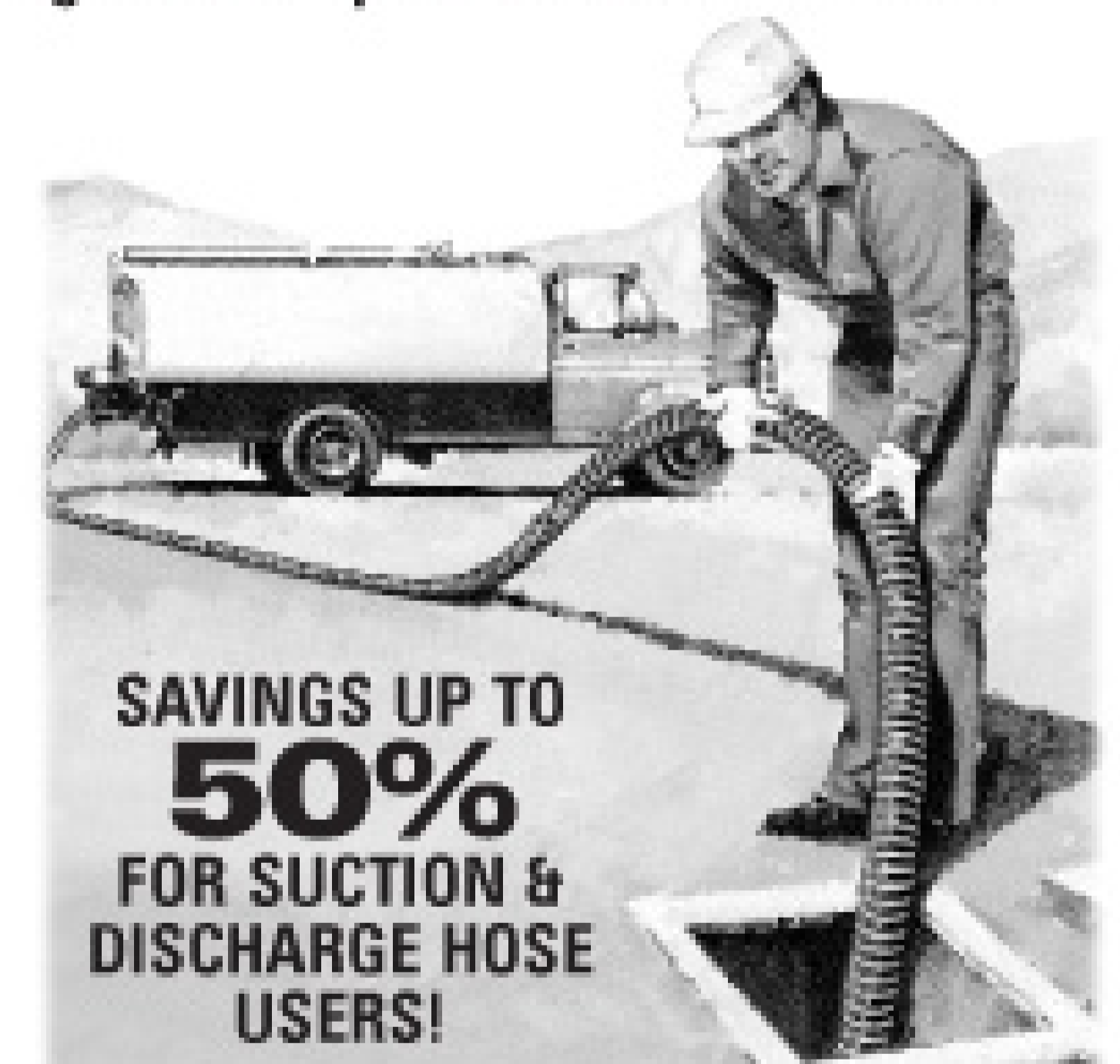

SAVINGS UP TO
50%
FOR SUCTION &
DISCHARGE HOSE
USERS!

MRP Toll-Free
1.800.325.3730
www.milwaukeeerubber.com

Milwaukee Rubber Products, Inc.

FAX: 262.781.1742

MAILING ADDRESS: P.O. Box 451 • Butler, WI 53007

WAREHOUSE: N52 W13319 Falls Creek Ct. • Menomonee Falls, WI 53051



NO COMPROMISE



Masport
HXL400WV



FRUITLAND
RCF500F



GD Wittig
RFL100



GD Sutorbilt
4M

At Armstrong Equipment, we believe life and business require certain compromises, but not on those things on which your business and family depend. A beautiful, new and shiny vacuum truck with a burned out pump is nothing more than uncomfortable transportation at four miles per gallon.

Your customers depend on you! Your employees depend on you! Your family depends on you!

We think you should be able to depend on **us!** That is why we sell the most dependable vacuum pumps, parts, valves and tank components available. When it comes to quality and reliability in the tools that make your business successful, there should be:

"No Compromise."

We proudly stock Masport, Fruitland and G-D Wittig vacuum pumps, Sutorbilt blowers, Garnet Instruments SeeLevel gauges, Clearflow Heavy Duty valves and most other vacuum truck components and accessories. We can also provide replacement pumps and repair kits for most major brands. For more information call us toll free at **800-699-7557.**

**ARMSTRONG
EQUIPMENT
INC.**

800-699-7557

11200 Greenstone Ave. • Santa Fe Springs, CA 90670

562-944-0404 • Fax: 562-944-3636

www.vacpump.com

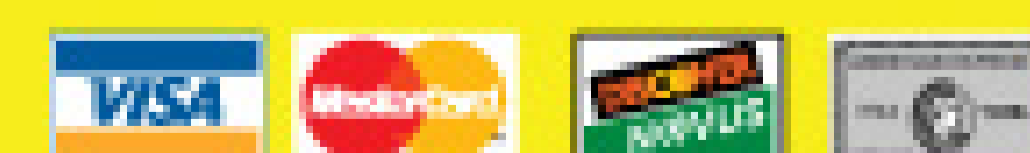

LOOKING FOR AN



IT'S A FACT:

Well engineered, quality-built restrooms are important to the success of a thriving business – not to mention your customer's satisfaction.

When the storage yard starts to fill up with worn out, un-usable, out-of-service units, it's not hard to figure that cheap restrooms aren't such a good buy after all. And

the temporary models that looked so pretty just a few months ago are now sitting idle, costing you money and customers, too.

The advantages of Vantage. The double-walled Vantage (right) is a top-of-the-line PolyPortables' restroom. It's engineered with common sense and built rock-solid, just like the rest of the PolyPortables' models.

ADVANTAGE?



Here are the advantages:

CUSTOMER-FRIENDLY

- Look at the size of that door! Tall, wide – easy for customers to enter and exit – even with bulky work gear.
- Keystone roof lets in plenty of light. The unit is brighter and feels more spacious.

SITE-FRIENDLY

- Easy to move and handle. 8 oversize handholds, corner strap-down guides and reinforced corners with no corner molds.
- Smooth easy-to-clean interior walls

EASY TO KEEP IN ACTION

- Most of the Vantage parts are interchangeable with PolyPortables' Standard and Integra models.

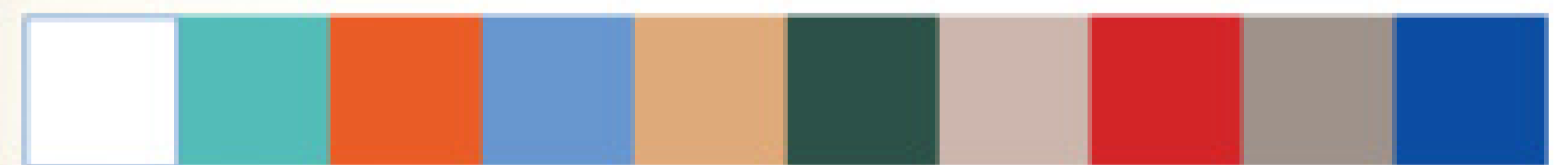

10 colors available now! Call about other available colors.

All this means you'll keep more units in the field, for longer periods of time, with less maintenance and hassle. The result: Happier customers and more money on your bottom line. Now that's an advantage!

PolyPortables: Good sense.



Listening. Learning. Delivering. Since 1972

Nothing keeps restrooms clean and fresh like Green Way Products deodorizers, cleaners and air fresheners.



99 Crafton Drive, Dahlonega, GA 30533 USA • Phone (800) 241-7951 or (706) 864-3776 • Fax (706) 864-8111 • www.polyportables.com



T&T Tools, Inc.

Fax: 800.521.3260
Email: sales@tandttools.com

800.521.6893

www.MightyProbe.com

Call for a FREE Catalog

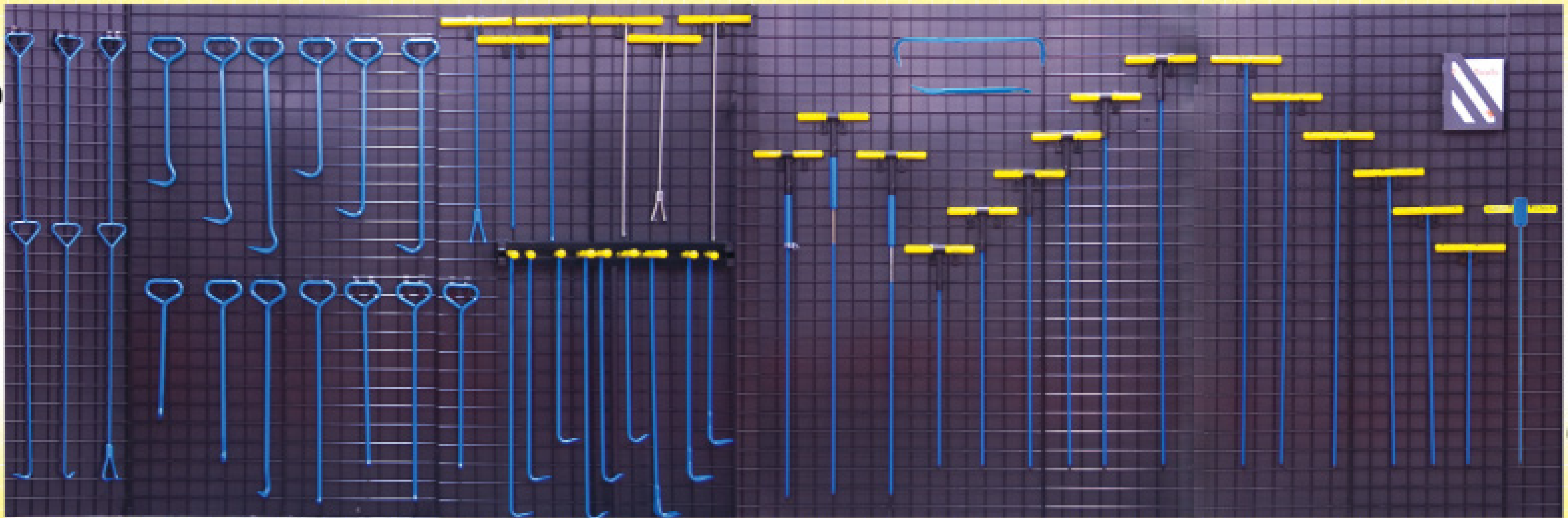

Call for a FREE Catalog

HOOKS...

- > Several different styles of heat-treated hooks are available
- > Top Poppers are great to open manhole covers
- > The Handy Hooks allow two handed use

PROBES...

- > Insulated, standard, and specialty soil probes
- > Metal shaft sizes: 3/8" round, 3/8" hex, or 7/16" hex
- > Replaceable tips are threaded on and hardened
- > A "slide" allows the handle to pound the shaft into the ground

ALL STAINLESS STEEL

12V DC Washdown Pump

- 100% Solid Stainless Steel Pump Components
No Rusty Pump • No Plastic • Freeze Tolerant
- Open Face Impeller Design
Allows Debris to Pass
- Totally Enclosed Motor
Compact Size • No Fan Problems
- Long Lasting Seal
- Reinforced Heavy-Duty Mounting Bracket for Truck Installation
- Flow Rates to 25 GPM
- Pressure to 45 PSI
- End Suction with Top or Bottom Discharge
- Available for Quick Factory Shipment

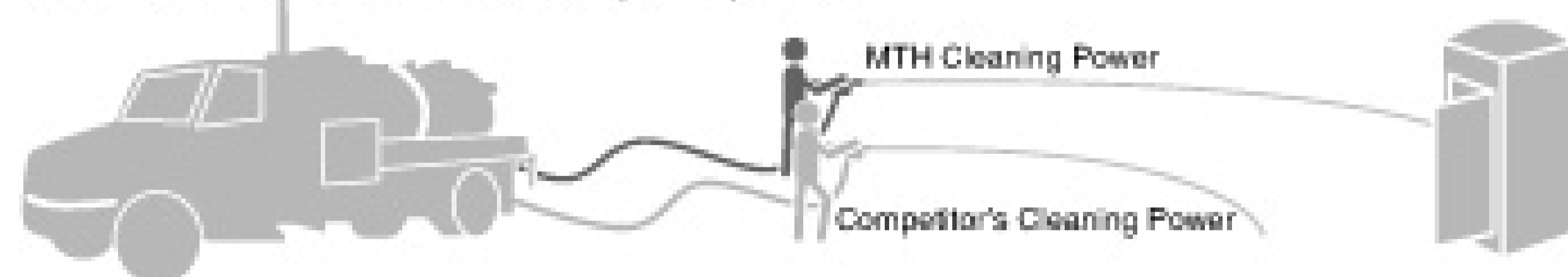

Call 630-552-4115 ext. 2, Email Pumper@MTHPumps.com, or Visit Us Online www.MTHPumps.com for More Information



Manufacturing Pumps in the U.S. for over 40 Years!

Bottom Free Trash Can

Invention of a trash can with no bottom.

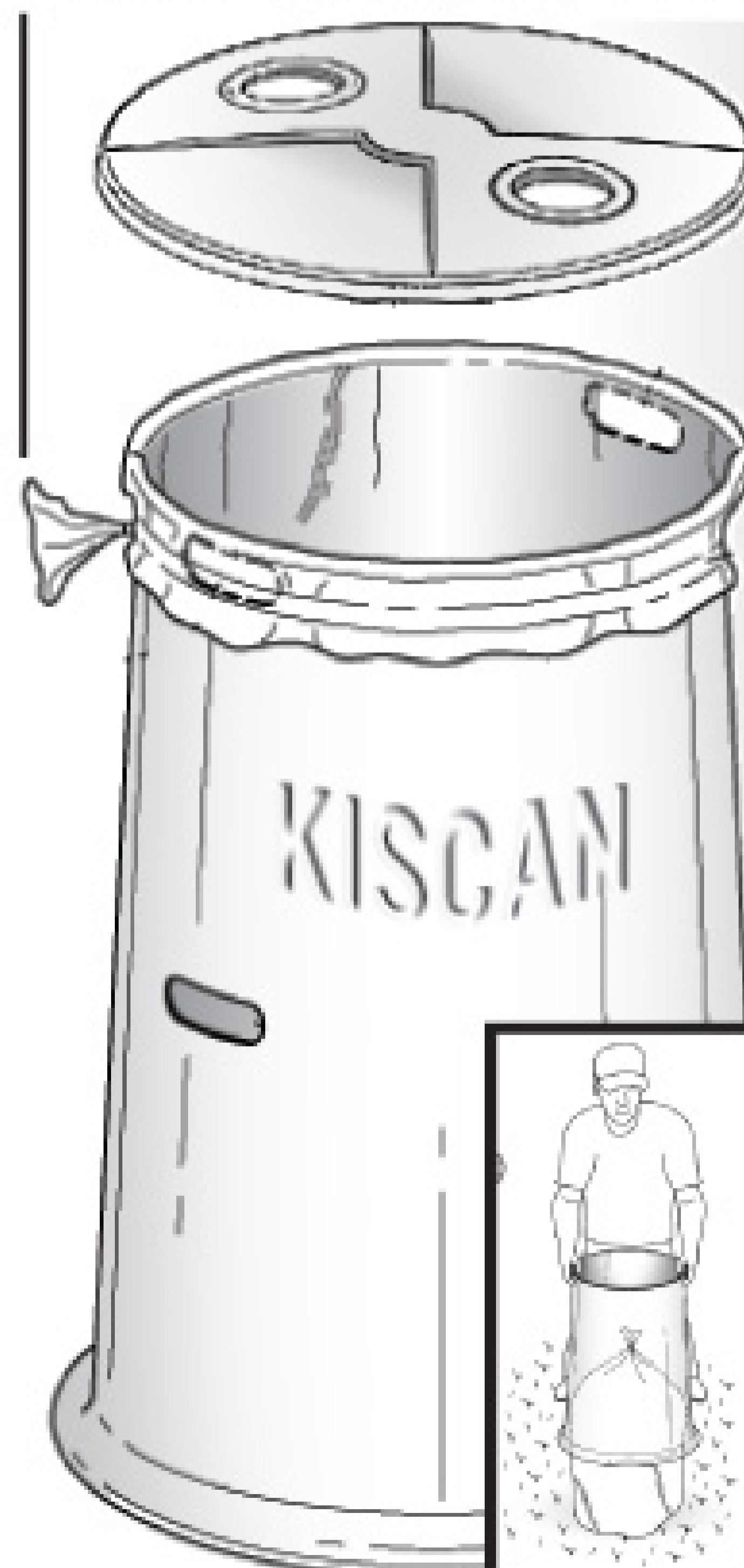

- Can be used for recycling
- Leaf collection during fall
- Trash only

Fill the bag and lift the can, not the bag, and save your back. No workmen's compensation to deal with.

Will allow licenses. You buy sub-wholesale and sell wholesale.

This ad is to see if there is an interest. Production pending.

Call **808-479-1876**

or email kiscanllc@yahoo.com

Patent pending.

POSSIBLY THE FINEST, MOST EFFECTIVE SEPTIC TREATMENT AVAILABLE

SUPPLEMENT YOUR INCOME BY SELLING A PRODUCT THAT WORKS ALMOST AS HARD AS YOU DO.



FREE SAMPLE PACK

FRITZ

SEPTIC

SEPTIC TANK TREATMENT



CALL US TODAY FOR A FREE SAMPLE:

800-955-1323 x158

LIMITED TIME OFFER - WHILE SUPPLIES LAST

Fritz Industries has been producing beneficial bacteria since 1978. Each bottle of Fritz Septic Tank Treatment is packed with the same concentrated microbes and enzymes used in your local water treatment plant to break down and digest waste. Improves percolation rate through leach field and opens drain lines.

- CONCENTRATED BIOLOGICAL FORMULA
- NON-TOXIC, NO HARSH CHEMICALS
- ENVIRONMENTALLY SAFE
- DIGESTS ORGANIC WASTE
- REDUCES OXYGEN DEMAND
- IMPROVES FLOW THROUGH LEACH FIELD AND DRAIN LINES
- REDUCES MAINTENANCE COST
- LUBRICATES AND CLEANS PUMPS

Fritzbio.com

PROUDLY MADE
IN THE USA 

Virginia Adds Mandatory Maintenance and Onsite System Evaluator and Designer Credentials

By **Scottie Dayton and Doug Day**

A Virginia law requiring mandatory maintenance for all alternative onsite systems goes into effect July 1, 2009. According to K.R. "Trapper" Davis of Coastal Plains Environmental Group in New Kent, alternative technologies include aerobic treatment units, peat biofilters, and soil-based systems such as drip dispersal, low-pressure pipe or mounds used with septic tank effluent.

On that date, certified maintenance operators, installers, soil evaluators, and designers must be licensed by passing a test and showing experience. Licensed evaluators and designers may design systems of up to 1,000 gpd for single-family homes. Anything beyond that requires an engineer stamp. The Department of Professional and Occupational Regulation recognizes that engineers typically do not have the education and experience to perform soil and site evaluations, and must therefore be licensed evaluators, too.

Davis says installers can no longer operate with a company business or contractor's license after the effective date. The project supervisor must be a licensed conventional or alternative

onsite sewage system Installer. Operation and maintenance technicians will have to pass an approved training course and exam, and show documentation of experience to qualify for an alternative onsite sewage system operator's license.

Even holders of wastewater operator licenses to run large plants do not automatically qualify. Onsite systems greater than 10,000 gpd will require a licensed wastewater operator with an alternative onsite sewage system operator license.

FLORIDA

Officials in Charlotte County say aging septic systems have polluted a beach and are causing ground contamination. County Health Department administrator Herman Velasco told a local TV station that many of the septic systems in Port Charlotte are more than 25 years old and his agency is finding corroded lids and outlets that allow septage to get into the soil, groundwater, and a canal that runs through the area into the ocean. The Port Charlotte Beach Complex was closed to swimmers June 12 to July 1 due to contamination.

A program to service and

inspect septic systems began in August 2007 after an order from the Florida Department of Health. The Managed Septic Systems program must continue until all residences are hooked up to a sanitary sewer system, according to the County Health Department Web site. The county's ordinance requires an operating permit every five years at a cost of \$115, including proof of a pump-out as well as verification of tank integrity and inspection by the county.

IDAHO

The Department of Environmental Quality has been holding hearings on a proposed change to the method of estimating wastewater flow from single-family homes and how soils are classified. The final proposal was expected in October or November with an effective date of July 1, 2009.

The agency says the revisions are needed to make regulations consistent with domestic water use in the state. Increased flow estimates will require an increase in the minimum size for a standard drainfield. Changing the soil classification from three soil types to six will allow more precise sizing of drainfields. The new regulations will also add definitions of the terms "bedroom" and "module." View the proposed rule online at www.deq.idaho.gov/rules/subsurface/58_0103_0801_proposed_rule.pdf.

MAINE

The Department of Health and Human Services is expecting draft changes to the Subsurface Wastewater Rules, perhaps by the end of 2008. A task force has been

"Rules and Regs" is a monthly feature in Pumper. We welcome information about state or local regulations of potential broad interest to onsite contractors. Send ideas to editor@pumper.com.

meeting for about two years. The task force of site evaluators, plumbing inspectors, installers, inspectors and representatives of regulatory agencies and equipment suppliers published several position papers that have been distributed for review and comment.

If all goes according to schedule, the new rules are expected to be effective April 1, 2009, after public hearings and a public comment period.

MARYLAND

The Department of Environment is still offering grants to cover most of the cost to upgrade septic systems through the Bay Restoration Fund. The grants fund the purchase, engineering, installation, inspection, and electrical connection costs, and the first five years of an operation and maintenance contract.

According to the grant application, the property owner pays for all other sewage disposal system costs, including conventional tank, distribution network, or effluent dispersal method replacements encountered or required by the local authority.

The grant has been available since 2005 for individual septic systems, small and large multiple residential units, and small and large commercial systems. The department says 20 percent of property owners in Maryland use septic systems. The grant program is part of the Chesapeake Bay Restoration Act. A \$30 annual septic tank fee provides the funds to upgrade about 600 systems every year. ■



"Duel Power Lid"
Plugs, Lids & Adaptor Rings
Sizes Available: 18", 24", 30" & 36"

 **Fergus Power Products**
Providing "Environmental Products"

The Company who maintains a pulse on the environment!
Toll Free **1-800-243-7584**
E-mail fpproducts@prtcl.com

Custom Dewatering Solutions.

With its low energy and Polymer usage,
BDP Industries Model 3DP Belt Press
will lower your carbon footprint!

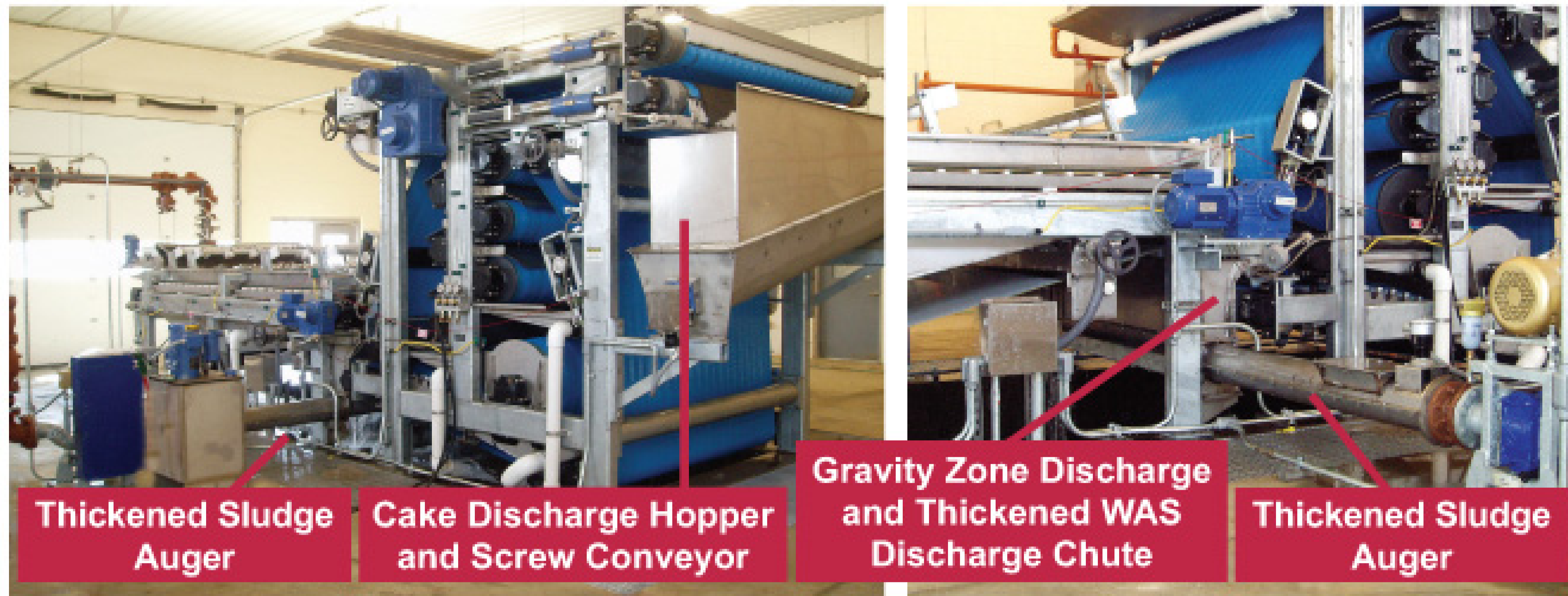

DUAL PURPOSE: 1.5m model 3DP designed to operate either as a Gravity Belt Thickener or Belt Press. A Flop gate assembly after the independent gravity zone directs sludge to either the thickened sludge auger or the pressure zone of the belt press.

Come by our booth and see a dual-mode unit and an animated video showing how the dual-mode functions.

With over **900 installations globally**, BDP Industries is one of the most modern and complete solids dewatering suppliers in the world.

- Gravity Belt Thickeners
- Belt Presses
- Rotary Drum Concentrators
- Lime Stabilization Systems
- Polymer Systems
- Compost Turning Equipment
- Pulp & Paper Stock Thickeners
- Process Control Panels
- Equipment Restoration
- On-Site Service & Mobile Demos

Visit us at
WEFTEC 2008
Chicago
Booth# 22103 Hall B



www.bdpindustries.com

HOSE ASSEMBLIES

MANUFACTURED TO YOUR EXACT HOSE REQUIREMENTS BY THE LEADING SOURCE IN HOSE FABRICATION.



**LOWEST PRICES
GUARANTEED
ON ALL OF OUR**

"QUICK-SHIP"

ITEMS

INCLUDING
HOSE & ASSEMBLIES
COUPLINGS • VALVES • ADAPTERS

300EPDM • 180AR • 180HR • 180BL
390SD • 220RS • GREEN PVC
KANALINE SR • KANAPOWER AT

Genuine

Kanaflex®

Assemblies by

ABBOTT

300EPDM HOSE NOW AVAILABLE IN COLORS

GREEN/BLACK - BLUE/BLACK - RED/BLACK



RUBBER COMPANY, INC.

1700 Nicholas Blvd. Elk Grove Village, IL 60007

www.pumperhose.com

1-800-852-1855 FAX: 847-952-0156

sales@pumperhose.com

MyTana



*Pumped the tank, but
it still won't drain?*



Get it done with our **M755**
Septic Saver cable machine

For a FREE Catalog... Call Toll Free: 800-328-8170 Fax: 651-222-1739 Request: www.mytana.com

ERICKSON

Tank & Pump

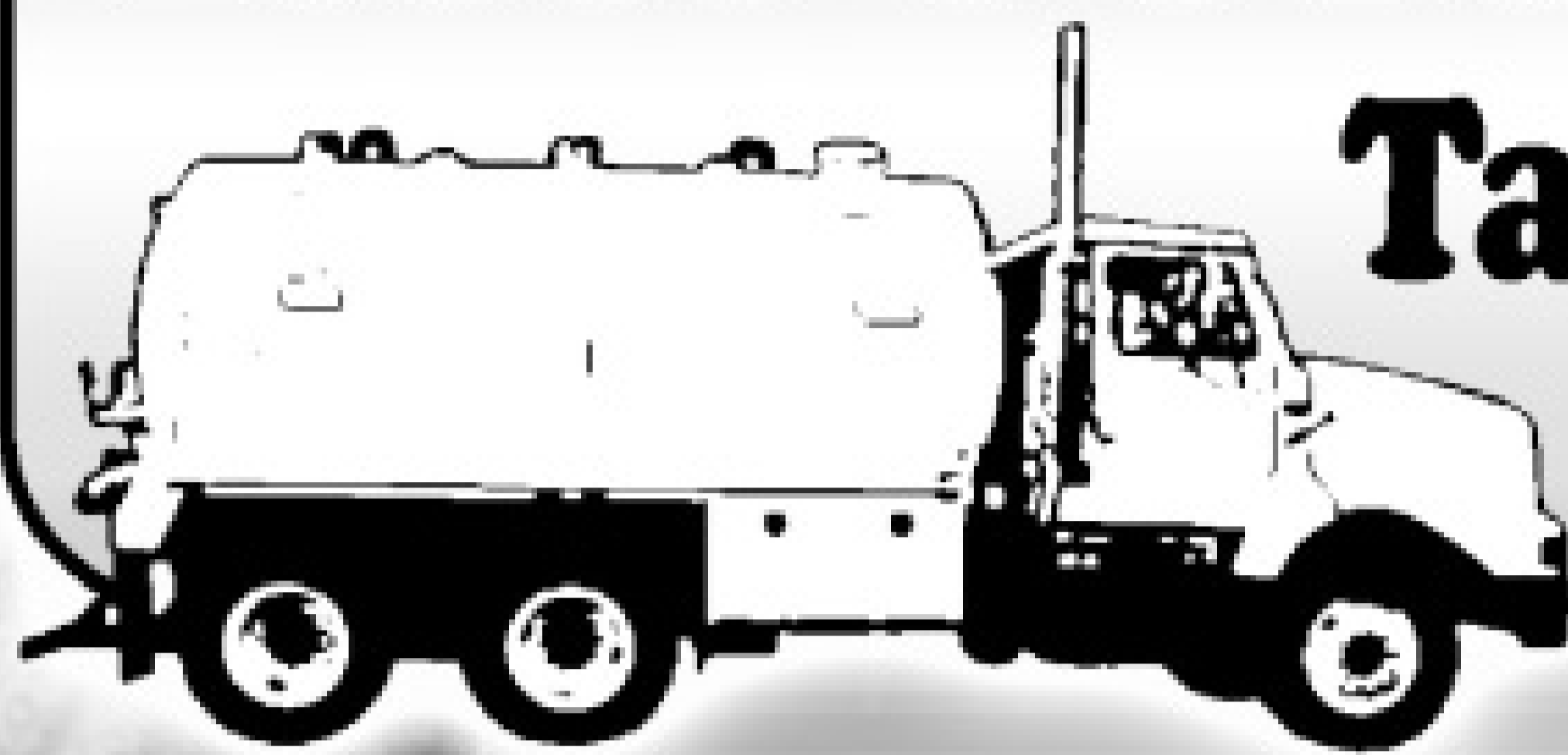

Large Inventory of
New & Used!

We Buy Pump Trucks and Take Trades!

THANKS TO OUR CUSTOMERS



Northshore School District, Bothell, WA
06 Freightliner w/3900 gallon tank



Charlie Loraas, Casper, WY
500 gal. trailer mounted vac tank



Pumpco, Okanogan, WA
270+100 potti pumper



Standard Biodiesel USA, Arlington, WA
04 Freightliner w/1600 gallon tank



PLEASE CALL
FOR A QUOTE

"Tanks" for your business!

Call for new & used equipment list.

800 Rd. P.5 S.W.
Quincy, WA 98848

• Fax: 509.785.3770
• E-mail: sales@ericksontank.com

509.785.2955

www.ericksontank.com

You Can't Buy A Better Reel.

Hose Reels for Cleaning and Pumping

- ✓ High pressure washing and cleaning
- ✓ Sewer, septic, portable toilet cleaning
- ✓ Video pipeline inspection
- ✓ OE vehicles and aftermarket upgrades
- ✓ Extra rugged, long-lasting design
- ✓ Complete custom capabilities



Download or call for your FREE Guide to Ordering Pumper/Cleaner Reels
<http://go.hannay.com/U16>
 877-467-3357

Hannay Reels®
 The reel leader.

MASPORT • PUMPS •

SALES • PARTS • SERVICE • STOCK

SUMMER SAVINGS ON SELECTED QUALITY MASPORT VACUUM PUMPS!

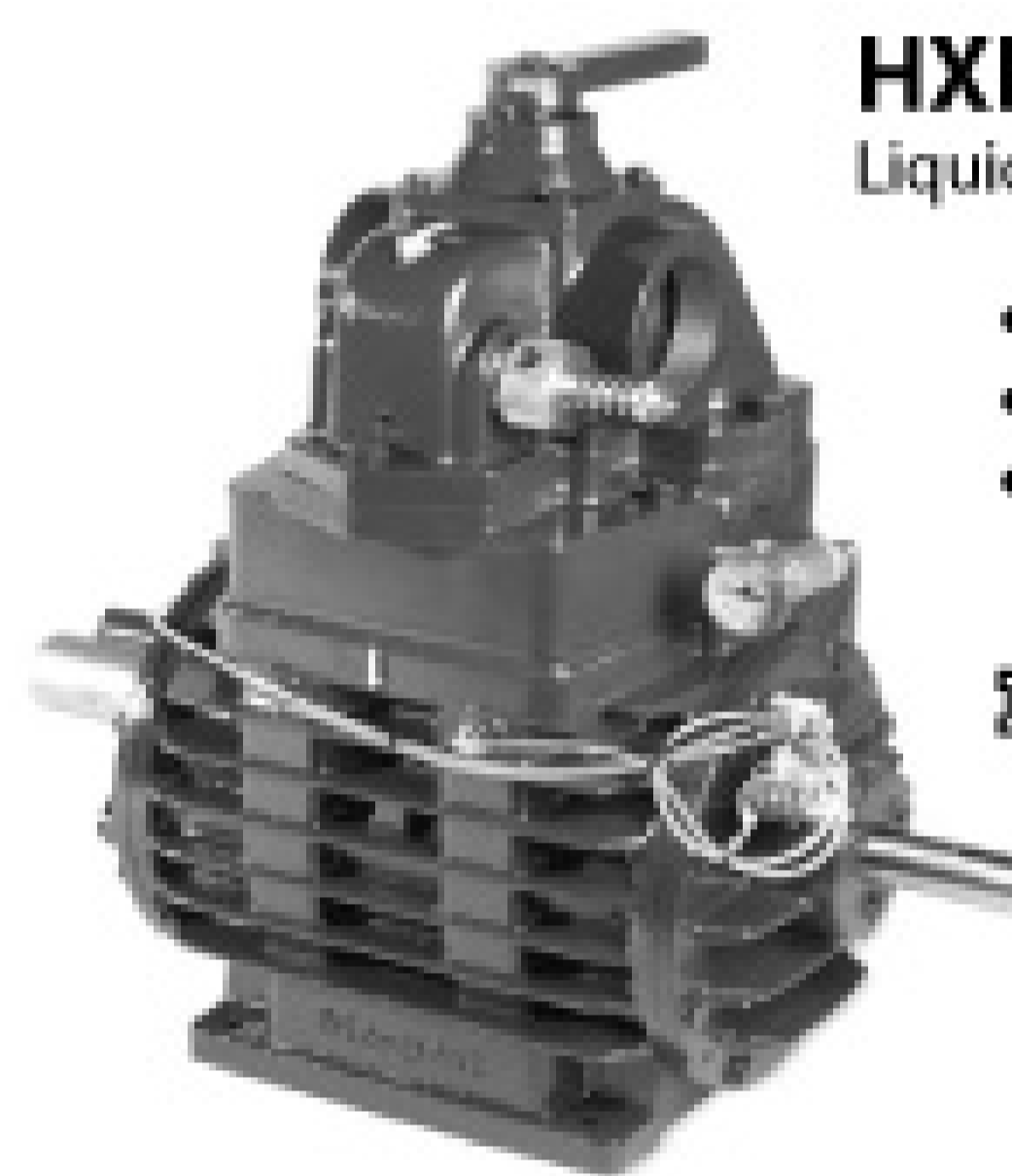

HXL20WV

Liquid cooled 410 cfm, 27" Hg. continuous vacuum

- Powerful
- Quiet
- Dependable

Masport

CALL TODAY FOR A FREE QUOTE!

WE OFFER MASPORT FIELD-PROVEN COMPONENTS TO UPDATE AND IMPROVE THE DEPENDABILITY OF YOUR VACUUM TRUCK OR TRANSPORT.



Masport



Masport

NEW SYSTEMS!

A wide range of Masport self-contained engine driven vacuum pump systems are available for the smallest to the largest vacuum truck or transport! •

WE STOCK AND SERVICE A COMPLETE RANGE OF **Masport** QUALITY PUMPS, COMPONENTS AND SYSTEMS!

We Put Over 40 Years of Experience to Work for You!
CALL TOLL-FREE 1-800-528-4843

YOUR AUTHORIZED MASPORT DISTRIBUTOR

JAMES WILBEE COMPANY INC. 150 Bellam Blvd.
 San Rafael, CA 94901
 415-457-6880
 Fax: 415-457-6930



27th TRUCKS INC.

WORLDWIDE EXPORTERS

8975 N.W. 27TH AVE. | MIAMI, FL 33147

PH: 305.835.9030 | EMAIL: INFO@27TH-TRUCKS.COM

Contact Alan @ 305-457-8058,
Armando @ 786-267-3026 or
David @ 786-236-9007

**2 Year
Factory Warranty
on Pumps**



1999 PETERBILT
CAT C12, 10 Spd, 430 HP,
3600 Steel Tank, Fruitland
Pump RCF 500, 350 CFM.

**\$75,000 Financing
W.A.C.**

Low Monthly Payments \$1,495

**\$78,000 Financing
W.A.C.**

Low Monthly Payments \$1,555



2001 MACK
10 Spd, 3600 Gallon Tank,
Fruitland Pump RCF 500, 350 C.F.M.
READY FOR IMMEDIATE DELIVERY!



2004 INTERNATIONAL 8600
CAT C12, 10 Spd, 4000 Gallon
Steel Tank, Fruitland Pump RCF
500, 350 CFM.
IN PRODUCTION

**PURCHASE YOUR
EQUIPMENT TODAY AND
TAKE ADVANTAGE OF
\$90 DOWN AND
\$90 A MONTH
UNTIL 2009 (W.A.C.)
FINANCING WITH
CAPITAL PARTNERS**



THANK YOU
Rodd Rodder from Puerto Rico



2005 MACK VISION
10 Spd, 4000 Gallon Steel
Tank, Jurop Pump LC420.
IN PRODUCTION



THANK YOU
David Crank from Louisiana

**10 Year Factory Warranty
on Aluminum Tanks**

**5 year Factory Warranty
on Carbon Steel Tanks**

WWW.27TH-TRUCKS.NET



Cold and Hot Water Pressure Washers

Simpson and Delco have been making top-quality pressure washer for decades. Available on trailers, skid mounts, or as portable models, our pressure washers give you the durability you want to keep cleaning on site, and the power you demand to clean your equipment back in the shop!

Call Bob Pligge at (847) 348-1573,
 email bpligge@simpsoncleaning.com
 or check out our websites
www.simpsoncleaning.com
www.delco-cleaning.com



Custom Dewatering Solutions

COST-EFFECTIVE, TURNKEY SYSTEMS

Built to your specifications

Municipal • Industrial • Septage

Mobile Units • Skid Systems • Sales • Rentals



**FRONTIER
 TECHNOLOGY,
 INC.**

Call 269-673-9464

609 N. Eastern Ave. • Allegan, MI 49010
 E-mail: frontiertech@frontierfilter.com
www.frontierfilter.com
 Fax: 269-673-9629

VS

*Four On
 Our Lot*

2009 Peterbilt 340 cab and chassis, New Presvac
 3,600 U.S. gallon, aluminum vacuum tank with a
 Masport HXL400WV, Liquid cooled vacuum pressure



**\$124,900
 Plus F.E.T.**

Vacuum Sales Inc.

51 Stone Road Lindenwold, NJ 08021

800-547-7790 Fax 856-627-3044

www.vacuumsalesinc.com

JOIN THE TEAM

Team

NVE

National Vacuum Equipment

800-253-5500

www.nvepump.com

Challenger™ Packages

- Industry Leading Design and Fabrication
- Dependable High Performance Vacuum Pumps
- Complete, Easy to install
- Reduce your Engineering and Installation Time
- Increase Profits

367 and 506 Muffler Pack

Includes: Fan or Liquid Cooled Vacuum Pump, Powder Coated Pump Stand, Gearbox, Pump Coupling, and Oil Catch Muffler

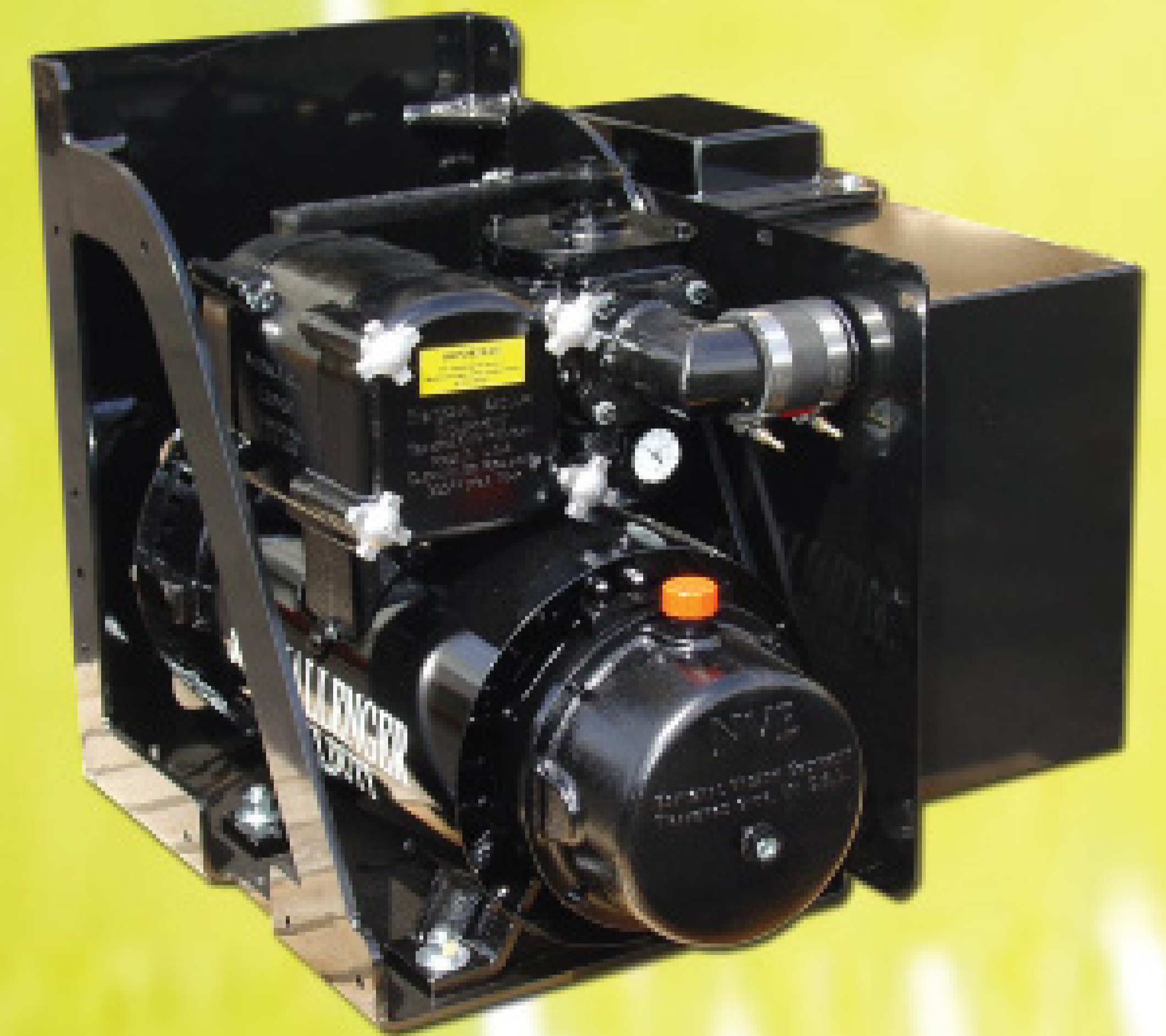

367 and 506 Max Pack

Includes: Fan or Liquid Cooled Vacuum Pump, Powder Coated Pump Stand, Gearbox, Pump Coupling, Secondary Shutoff, Oil Catch Muffler, Vacuum & Pressure Relief, and Vacuum Pressure Gauge

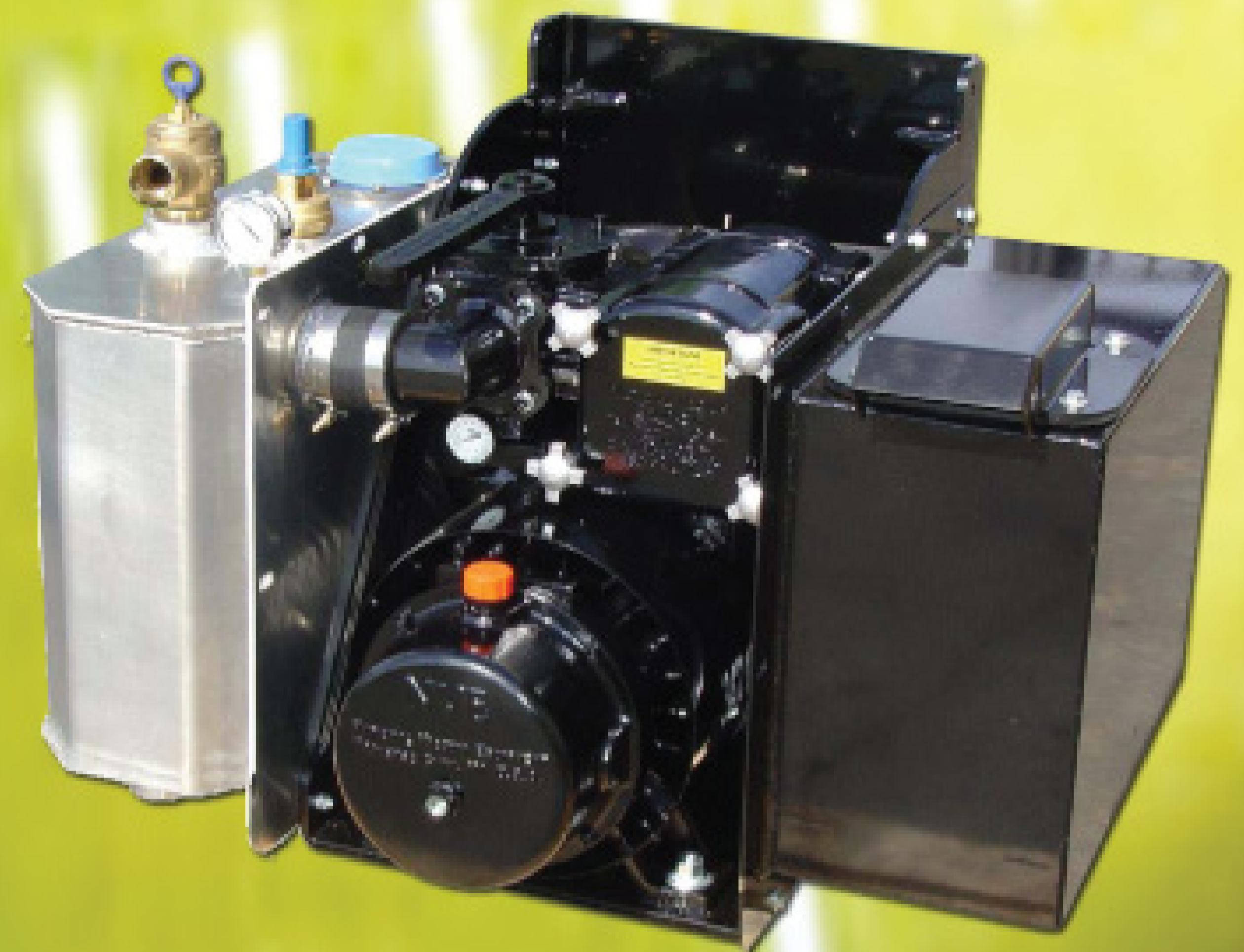

Join the most Powerful Team

with the Best Performance Products!

Supersucker®

The Best Industrial Vacuum Unit on the Market Today!

- ◆ Heavy duty construction to tackle jobs in the most extreme conditions
- ◆ Designed for easy operation, easy cleaning and easy maintenance
- ◆ Unloads efficiently to save both time and money
- ◆ High dump option allows rear lift height to 60"

Contact Super Products today for more information on our line of Supersuckers or to schedule a free demonstration!

800.837.9711 • www.superproductscorp.com



Super Products
Worldwide Vacuum Technology



Save Time! Save Money! With a Stellar Hooklift!



- One truck can support numerous bodies, which cuts cost and maintenance
- Over 40 models available, capacities up to 65,000 lbs.
- One truck operator can, without leaving the cab of the truck, load and unload or change truck beds in less than a one minute cycle
- Patented dump/load interlock system
- Gravity type safety latches are used to prevent accidental detachment of the body
- Rugged rear body tie-downs and large over-sized rear hinge pins to insure stability
- Low maintenance
- Unlimited uses

The Stellar Hooklift Interchange System...Explore the Possibilities!



*Our People.
Our Products.*

800-321-3741 • www.stellarindustries.com



BEST ENTERPRISES, INC.

Stainless makes the difference. All Stainless Tanks

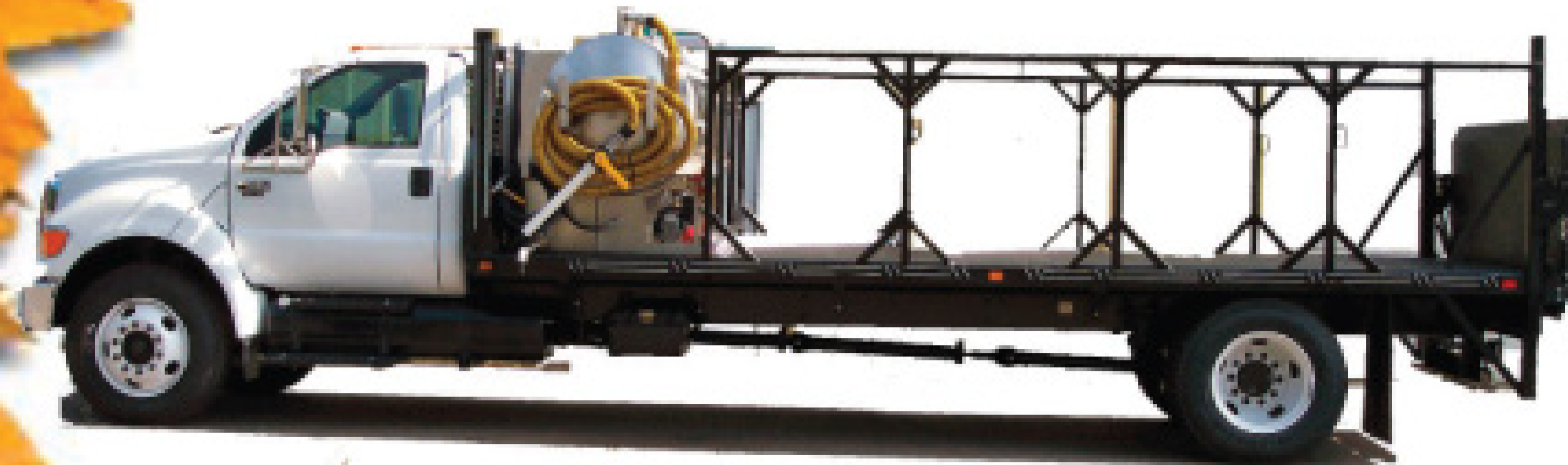

Slide In Units



Best Enterprises, Inc.
3513 W. Mt. Springs Rd.
Cabot, AR 72023
1-800-288-2378
www.bestenterprises.net

Old Pueblo Septic and Drain Service owners Amy and Scott Ziegler stand next to an International 2300 truck with 2,300-gallon tank as they speak with their father, Scott Ziegler. (Photography by Jeffrey Scott)

Profile

Old Pueblo Septic and Drain Service Inc.

Tucson, Ariz.

Owners: Scott and Amy Ziegler

Founded: 1959

Employees: 10

Services: Residential pumping and commercial grease traps

Service area: Pima County

Affiliations: National Association of Waste Transporters Inc.

Web site: www.oldpuebloseptic.com

ARIZONA



IN GOOD HANDS

Valuable life lessons and understanding of the business resulted in an orderly family ownership transition for Old Pueblo Septic and Drain Service

By Ken Wysocky

Cover Story

Veteran septic-waste pumper Steve Ziegler has a bit of advice for business owners who want to pass along a family-owned company to their children: First make them work for someone else.

"My wife, Pam, and I preferred that Scott and Amy work elsewhere before they took over here," he says, referring to his son and daughter, who bought the family company, Old Pueblo Septic and Drain Service Inc. in Tucson, Ariz., earlier this year. "They both went to college and worked for other people.

"They got to see good bosses and bad bosses, people who do their jobs and some

who don't — the whole ball of wax," he continues. "Working for other people made them more well-rounded. They were able to relate everything they've seen in other companies to our business ... in the end, it was a perfect fit."

Scott Ziegler, 34, and sister Amy, 31, agree wholeheartedly with their father's philosophy. For Scott, who started working for Old Pueblo in 1994, testing the employment waters elsewhere meant a two-year stint at a national freight delivery firm after attending college.

"I got to see the whole union thing as well as see how different supervisors go about their jobs," he says. "I found it was difficult to work for people who weren't always looking

out for the best interests of the company. For me, it's all about customer satisfaction and working hard ... and then seeing the product of your hard work."

Amy initially went to college to become a teacher, but instead earned a degree in business administration, with an emphasis on small-business management. She worked at a fast-food restaurant from age 16 to 22 and also worked as a janitor while attending college.

"Working for other people gave me a good perspective on how to treat employees," she says. "I had some supervisors who cared about their employees and helped them improve, and others whose attitude was just,

“MY EXPERIENCE HAS MADE ME MORE OF A HANDS-ON MANAGER — MAKING SURE OUR EMPLOYEES GET WHAT THEY NEED. THEY’LL TAKE CARE OF YOU AND THE COMPANY AS GOOD AS YOU TAKE CARE OF THEM.”

Amy Ziegler



Above, septic technician Terrell Hill (left) and Steve Ziegler drain waste from a pump truck prior to processing. At left, Hill cleans debris and trash filtered from the sewage strainer.



“I found it’s easier to do one thing really well than to get spread too thin elsewhere,” he says. “Scott and Amy might want to do that, but that’s up to them and their business philosophy.”

IN-HOUSE DISPOSAL

Ziegler is still around to give his children advice, if needed. In 2000, he started processing Old Pueblo’s waste, and under the terms of the company’s sale to Scott and Amy, he’ll keep operating the processing side of the business.

Two things prompted the decision to start processing the company’s waste, Ziegler says.

“First of all, the Pima County wastewater facility never accepted waste from car washes and grease traps, so to keep some of my business, it was something I had to do. Also, I didn’t want to be left high and dry if they ever

‘Go out and make money for me.’

“My experience has made me more of a hands-on manager — making sure our employees get what they need,” adds Amy, who started working at Old Pueblo in 2001. “They’ll take care of you and the company as good as you take care of them.”

STARTED SMALL

Steve Ziegler bought Old Pueblo in December 1987 after working for the local electric utility for nine years.

“At the time, I was looking for a service industry that appealed to me,” says Ziegler, who majored in management and marketing in college. “I preferred working outdoors and doing physical work — and I probably got more than I bargained for.”

Ziegler quickly learned two important lessons: excellent customer service and hard work were paramount to success.

“When I started out, I had just one old truck,” he says. “I just kept on pushing and working. If a job came along at 8 p.m., I’d take it.”

Today, Old Pueblo’s fleet includes seven trucks, all outfitted by Glendale Welding in Phoenix: a 1999 International with a 3,600-gallon tank and

2001 through 2007 Internationals with 2,600-gallon tanks. The 1999 International is equipped with a Masport HXL15WV pump (332 cfm). The other six trucks rely on Masport HXL75WV pumps (229 cfm).

Over the years, Ziegler said he often considered branching out into other related services, such as manufacturing septic tanks or servicing portable restrooms. The current business mix is about 85 percent septic pumping and 15 percent cleaning grease traps.

Service technician Zep Homes stands next to an International 4300 with 2,500-gallon tank. Old Pueblo Septic and Drain Service has seven vacuum trucks in its fleet.



“THE TREATMENT PLANT IS ONLY FIVE MILES AWAY, BUT YOU HAVE TO PUSH A BUZZER WHEN YOU GET THERE, THEN WAIT FOR A GUY TO COME FROM THE OTHER END OF THE PLANT BECAUSE IT’S NOT MANNED 24 HOURS A DAY. BUT WHEN YOU PROCESS YOUR OWN WASTE, THE TRUCKS CAN COME BACK HERE AND DUMP THEIR LOAD AT THE SAME TIME ... THEN GO OUT AND FILL TWO MORE TANKS, COME BACK AND DUMP AGAIN, AND SO ON. IT WORKS OUT REALLY WELL.”

Steve Ziegler

decide to stop accepting sewage waste.

“In addition, in August 1999, the county started charging 9 cents a gallon to dispose of sewage. That was quite a shock — that’s \$90 for 1,000 gallons of waste.”

Moreover, taking waste to the sewage treatment plant was a time-consuming process that hurt productivity.

“The treatment plant is only five miles away, but you have to push a buzzer when you get there, then wait for a guy to come from the other end of the plant because it’s not manned 24 hours a day,” he says. “But when you process your own waste, the trucks can come back here and dump their load at the same time ... then go out and fill two more tanks, come back and dump again, and so on. It works out really well.”

There’s one more benefit: a second revenue stream.

“It’s a sign of the times — people have a hard time finding places to dispose of waste,” Ziegler says. “I figured that if we processed our own, a pumper could make a few extra dollars for himself, and it’s a lot more convenient, too.”

DEWATERING BOX

Taking a step into the unknown and purchasing a \$100,000 vacuum drum processing



Amy and Scott Ziegler use software to handle everything from dispatching and routing to customer records and office management.

system, made by Alar Engineering Corp., was scary, Ziegler admits.

“On the other hand, I knew how much waste I was processing, so I knew what kind of return to expect on my investment,” he points out.

Ziegler recently switched to a new processing system that combines a Series 6000 liquid polymer feeder, made by Excell Feeders Inc. (feeding capacity of 240 gpd), and a 30-yard dewatering box, made by Flo Trend Systems Inc. The new system is simpler to operate, plus it can process two to three times as much waste, depending on the waste stream, he says.

On top of new technologies

After decades in the septic waste-pumping industry, Steve Ziegler realizes the importance of keeping up with new developments in systems and equipment that can increase profitability and productivity.

“You have to stay on the cutting edge of technology,” he says. “Otherwise the competition will use them and slowly gain market share. We’re very aggressive when it comes to technology.”

That wasn’t always the case, he observes.

“We used to push paper and use pencils,” he says. “But when Scott (his son) came in, we got computerized. We’ve evolved a lot in the last 10 to 15 years. Now it’s as if we can’t do anything without computers.”

Scott Ziegler says the company relies heavily on Total Activity Control software from Clear Computing Inc., which handles everything from dispatching and routing to customer records management to office operations.

“It keeps track of all our customer orders,” he says. “When a customer calls, we know the location of the tank, the style of the tank, its depth and more. If the property changes hands, we can see what we’ve done for each homeowner.”

That knowledge helps polish the company’s image, Steve Ziegler says.

“Our technicians know if a tank is, say, under a patio or below a brick wall, so they look knowledgeable,” he explains. “They know where they’re going and what they need to do. Customers see that and think, ‘Wow, these guys really know what they’re doing.’ Plus, the quicker we can do a job, the less it costs the customer — and the sooner we can get to another job.”

“There’s a lot more equipment out there now,” he says when asked what advice he’d give to a pumper who’s thinking about getting into waste processing. “What works for one may not work as well for another. I’d visit some companies that process their own waste and see what works and how things are set up.”



Steve Ziegler helps Zep Holmes open a septic tank, then checks to see if another lid needs to be removed.

GROWTH CURVE?

One of the main challenges Old Pueblo's new owners face is deciding how much bigger they want the company to grow. The company adds about 100 new customers a month, compared to about one a day 20 years ago, Scott Ziegler says.

"We now have more than 20,000 customers on our database," he adds.

"We don't want to get much bigger — we're hoping that seven trucks is it," Amy Ziegler says. "But more customers keep coming."

"We just can't tell a customer no," Scott Ziegler says. "We're not hungry to get bigger, but when you do a good job, the business keeps coming in."

Finding and retaining reliable, qualified technicians who have the right attitude about customer service also poses a challenge, the siblings say. But Old Pueblo works to retain employees by offering better-than-average pay and creating a nurturing atmosphere. For instance, technicians can get time off to attend their children's school functions and the like.

"If they just let us know far enough in advance, we work around things like that," Steve Ziegler says. "That's the way we'd want to be treated if we were employees."

"We're so small that we're able to be very

hands-on with the drivers," Amy Ziegler says. "We want them to get the sense that they're more than just employees. Technicians in the crew we have now have been with us for anywhere from one to eight years."

Steve Ziegler points out that two employees recently left, but came back after working elsewhere — with no hard feelings on anyone's part.

"Do we work our employees hard?" he asks. "Yes. But we're fair, too. If they want to try something else, go ahead. We're not going to hold it against anyone for trying to better themselves."

FAMILY TRADITION

Scott and Amy Ziegler are proud to keep running the family business because it reflects well on what their parents strived mightily to build.

"We like to see the business grow," Amy says. "It makes us feel successful to be able to continue it. We watched our parents work hard for years, so running the business comes naturally. We've always been close and honest with each other, and I believe that's what has helped us grow."

Scott Ziegler says: "Our parents instilled in us the value of hard work and good ethics. That's why about 80 percent of our business

comes through referrals. We don't have to do much advertising."

Steve Ziegler is also pleased about Scott and Amy's ability to balance work and family — something he admits was difficult for him.

"It's not all about money," he says. "You need to have family time, too. You can get so wrapped up in the business that you lose sight of everything else."

"They do a much better job than I did; it's gratifying to see them strike a balance," he continues. "It's good to see the business is organized enough that they can take time off and enjoy life a little bit."

Thanks to the valuable perspectives they've gained over the years, it sounds as if the young entrepreneurs plan to do just that. ■

MORE INFO:

Alar Engineering Corp.
708/479-6100
www.alarcorp.com

Clear Computing
888/332-5327
www.clearcomputing.com

Flo Trend Systems Inc.
713/699-0152
www.flotrend.com

Glendale Welding
623/937-7414
www.glendalewelding.com

Masport Inc.
800/228-4510
www.masportpump.com

VACUUM TANKS - WE'VE GOT WHAT YOU NEED!



**5 YEAR
WARRANTY
ON ALL
NEW TANKS**

4,000 - 10,000 GALLONS

THE BEST ALUMINUM VACUUM TRAILERS IN THE INDUSTRY!

CALL US FOR A QUOTE TODAY!

Longhorn Tank Co.

800-422-9840 • FAX 479-787-6935

P.O. Box 1147 • Gravette, AR 72736

**The solution for
ALL
of your vacuum
tank needs!**

FRUITLAND VACUUM PUMPS. SIMPLY THE BEST

We are the #1 vacuum vane pump servicing the oil fields across North America.

The reason is simplicity.

**We don't need gimmicks or water cooling to serve the harshest of applications.
Simple uncomplicated design that works.**

Features:

- Every Pump "Factory Tested"
- Low Maintenance Cost
- Continuous Duty
- Air - Cooled
- No Washboard
- Vacuum to 28 hg.
- Pressure to 30 psi.
- ISO Certified
- 2 Year Factory Warranty
- Automated Lubrication System
- User friendly Maintenance Features
- Models for Tanks sizes from 1000 to 12000 Gallons
- Drive option include; Hydraulic, Direct, Belt, and Right - Angle
- Proven in all environments (sub-zero to 100 degrees plus)



Markets:

- Industrial •
- Oilfield •
- Septic •
- Grease •
- Environmental •
- Wastewater •

**Used and Proven by
World's Top Liquid
Vacuum Service Companies.**

**Vacuum Pump Training
Courses available*

Fruitland Tool & Manufacturing

" Committed to Quality, Reliability, and Guaranteed Performance "

Contact us today: **1-800-663-9003**
Visit us @ www.fruitland-mfg.com For more info.

***We Squeeze the Crap
Out of Water™***

**Rotary Thickening
and Dewatering**

**Simple systems that are
totally enclosed, compact
and easy to operate.**

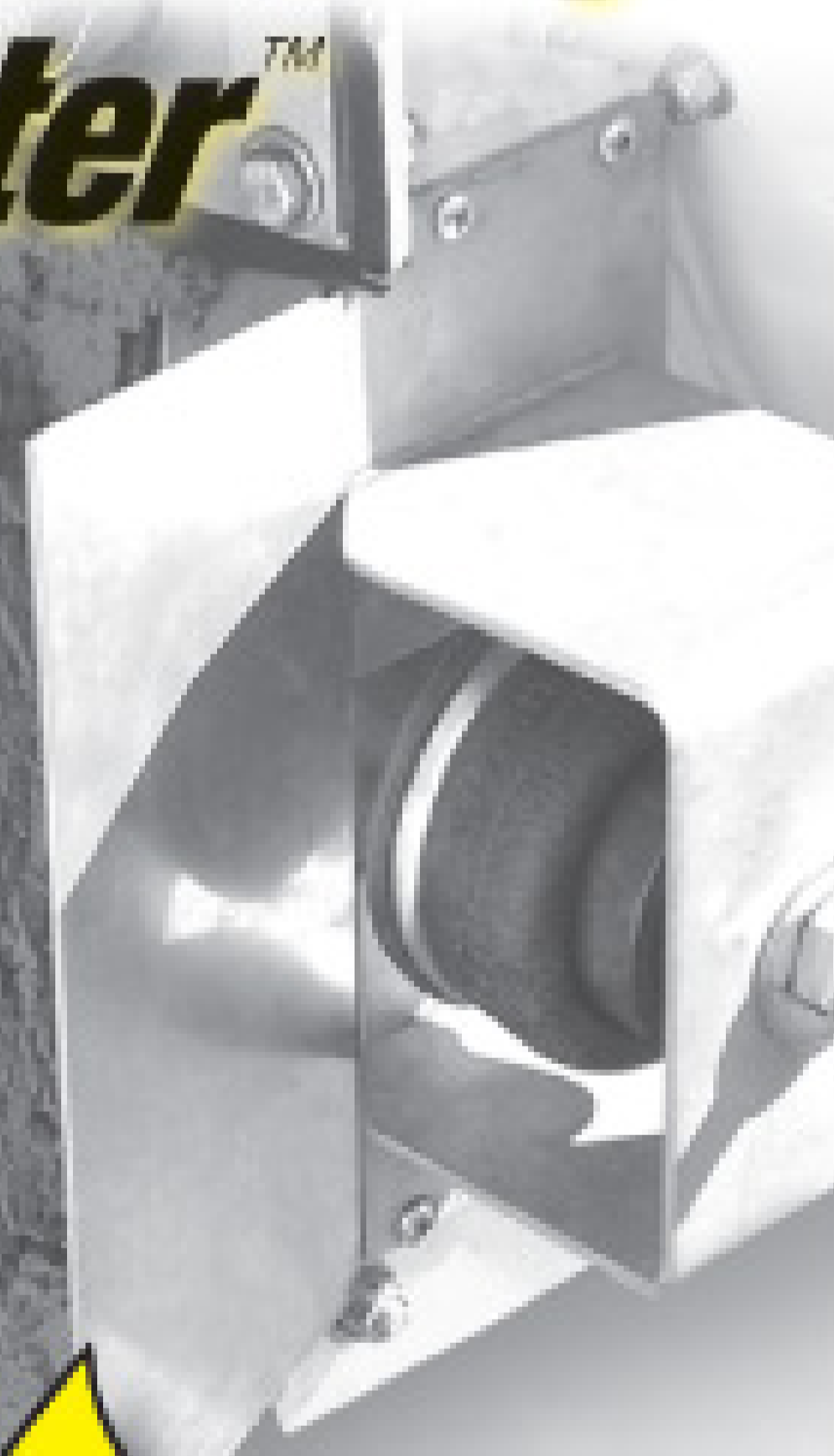

PH: 269-673-9559

www.primesolution1st.com

Made In USA

NUCONCEPTS

MANUFACTURER OF QUALITY PORTABLE RESTROOMS AND SINKS



Dual VIP Restroom Trailer

From \$9,841

Ideal for:

- Weddings / Parties
- Sporting Events
- Food Festivals
- Community Events
- Restroom Remodeling
- Movie Production

Features:

- Solar Powered
- Self-contained
- Flushing, china toilet
- Enclosed sink
- Power Converter (option)
- Air-conditioning (option)
- Interior Heater (option)
- Sink Water Heater (option)



1737 S. VINEYARD AVENUE • ONTARIO, CA 91761

PHONE 909-930-6244 • TOLL FREE 800-334-1065 • FAX 909-930-6237

WWW.NUCONCEPTS.COM

Refuse Systems

Your truck specialists in the solid and liquid waste industries.



2008 Peterbilt 365 with 5000 Gallon Tank

CAT C13 430HP 1650 Ft/Lbs Torque, Full Compression Brake (Three Stage), Allison 4500 RDS-P with 5YR/Unlimited Mile Warranty, 20,000# Front Axle; 46,000# Rear Axle, Peterbilt Air Trac Suspension, Full Locking Differential, Aluminum Wheels on Outside, Hendrickson Compositelite 13.2K Steerable Pusher Axle, Air Ride Driver Seat, Adjustable Steering Column, Power Windows, Locks, Cab Air Suspension, Pik Rite 5000 Gallon Carbon Steel Tank, See Level – Digital Tank Level Indicator, Moro PM100 Pump, Aluminum Hose Trays, 4" Intake, 6" Discharge.



Peterbilt 340 Industrial Vacuum Trucks

Automatics and Standards in stock ready for delivery. DOT 407/412 3150 Gallon Cusco units. Moro PM100 Pump, Hydraulic full opening rear, Vibrator Box, Air actuated valves, Full Walkway with handrail, 20 Ton Dump Capacity Cylinder.



Peterbilt 340 Standard Vacuum Trucks

Automatics and Standards in Stock ready to go to work. Non Code 3600 Gallon Pik-Rite Tank. Masport HXL400WV Liquid Cooled Pump, Aluminum Hose Trays, Internal Primary to secondary Piping for clean mount. 10 yr Tank Warranty Standard. Options can be added before delivery. Compare our standard Specs to anybody!



2008 Peterbilt Roll Off

Cat or Cummins, automatic or standard transmission, 20fr/ 46 rears, Air Trac or Hendrickson suspension, 60k or 75k hoists, Pioneer or O'Brian tarpers, mounted or cab and chassis still available.



2007 Pre-Emission and 2008 Peterbilt Cab and Chassis

Whether you're putting an old tank on a new truck, or custom building a truck the way you've always wanted, call us and choose from a wide variety of models and specs on the ground. Fast shipping available to your destination. Tank dealers and manufacturers welcome.



www.rushrefusesystems.com



877-661-4511

Refuse Sales Team: Gregg Wilkinson | Jason Guzauskas | Jesse Fullilove | Ryan Johle | refusesales@rush-enterprises.com

8810 IH-10 East | San Antonio, TX 78219



**The most rugged, dependable
longest lasting vacuum pumps
in the industry!**

wallenstein septic pumps

Components



**Dome Style
Hatch**



Secondary



Primary



220 CFM



275 CFM



350 CFM



Oil Catch

*only available through
factory authorized distributors.
Some territories still available.*



**4 Way
Valve**



**Stem
Valve**

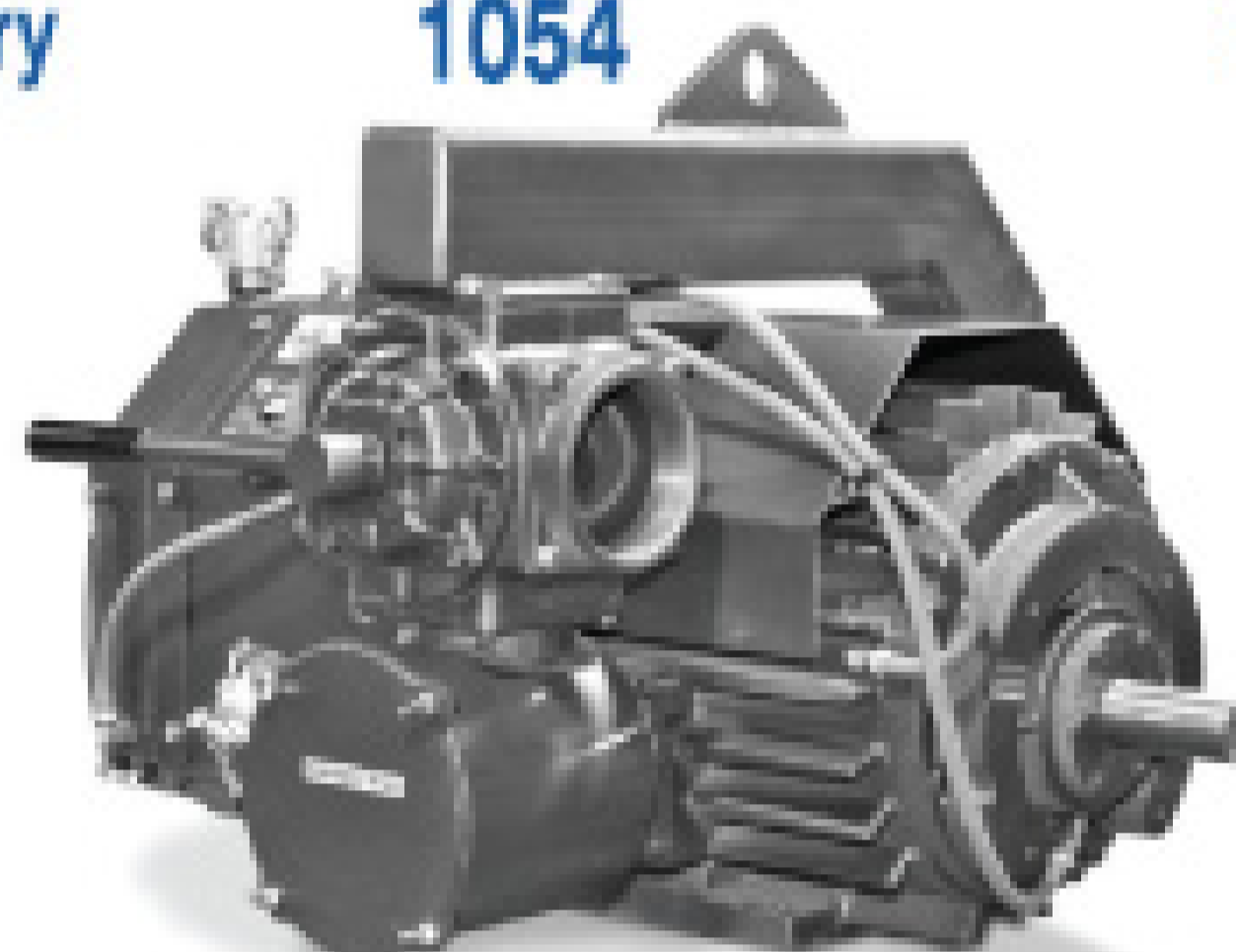

500 CFM

Series	Rating CFM	Vacuum "HG	HP $\frac{1/2$ " Engine	Tank Size US Gallon
403	220 @ 1150	27	18	2000
553	275 @ 1150	27	24	2500
753	350 @ 1150	27	30	3500
1054	500 @ 1000	27	40	5000+

Toll Free 1-800-801-6663 fax 519-669-8331 email info@wallensteinpumps.com

Call for product literature and your nearest Authorized Distributor.

Comforts of Home Services, Inc.

LUXURY TRAILER SALES



*Units come with A/C, Heat, HD
Steps and a Large 300 Gallon Waste Tank*

- Lowest Interior Floor Height in the Industry
- ADA wheelchair accessible units.
- Unlimited Floor Plans from 8' to 53' Trailers
- Rigid Steel Shell Construction from top to bottom to resist rot and warping.
- Specializing in Customizing trailers to fit your needs.
- Easy Fold-Up Steps & Door Handles
- 24/7 Tech Support for the best customer service available.
- Free Nation Wide Lead Program for our customers.
- Large Capacity Waste Tanks
- High Privacy Partitions are Standard for Added Comfort
- Rigid Platform, our smallest wide body trailers start out with Dual 10" ASTM I-Beams.

See our website for more layouts and options.



INFO@COHSI.COM • 877.382.2935 • WWW.COHSI.COM

**Rental and Leasing Services Available!
Call Today!**

**Call For
FREE DVD**

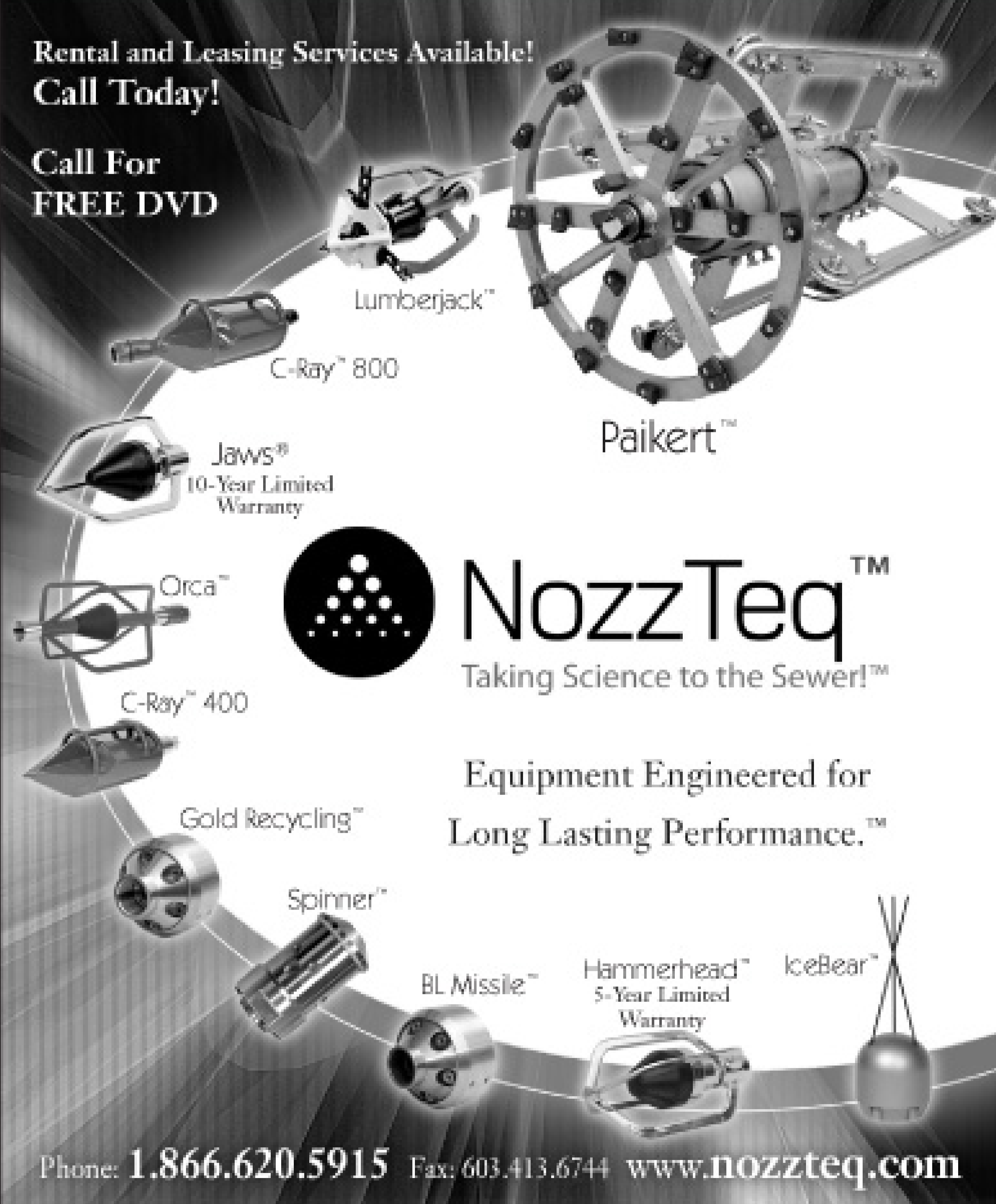

Lumberjack™

C-Ray™ 800

Paikert™

Jaws®
10-Year Limited
Warranty

Orca™

C-Ray™ 400

Gold Recycling™

Spinner™

BL Missile™

Hammerhead™
5-Year Limited
Warranty

IceBear™

NozzTeq™
Taking Science to the Sewer!™

Equipment Engineered for
Long Lasting Performance.™

Phone: 1.866.620.5915 Fax: 603.413.6744 www.nozzteq.com

TRANSPORT TRUCK SALES, INC.

Ask for **Scott or Frank** – **888-395-7551**
 After hours call **Scott** at **816-590-4076**



What Does It Take To Be A "Qualified Chassis"?

- ✓ Pass our **12 point** checklist. (We send this out with every quote!)
- ✓ Pass a **D.O.T.** certified inspection!
- ✓ Pass the **warranty** inspection!

What Does All This Do For You?

- ✓ **Nationwide drive train warranty for 2 years/ 200K miles!** (restrictions apply)
- ✓ **A tough truck that is ready to work as hard as you do!**

YOUR TRADES ARE WELCOME!

Searching For A **Brand New Chassis?**
We Have Them In Stock!



2002 Freightliner FL-80, CAT 250HP, 9 spd, 33# GVW, air brakes, AC, new 2300 gallon steel vac tank, new Jurop PH-84 vac pump.

Call For Pricing!

2-YEAR 100,000 MILE DRIVE TRAIN WARRANTY



2002 Mack CH613, E-7 400HP, 10 spd, jakes, AC, double framed, LOW MILES, new 3360 gallon steel vac tank, new liquid cooled Masport HXL-400 vac Pump.

Call For Pricing!

2-YEAR 200,000 MILE DRIVE TRAIN WARRANTY



2002 Freightliner FL-112, CAT C-10 350HP, 9 spd, jakes, 14,600# fronts, AC, double framed, new 3600 gallon Alum. vac tank, new Masport HXL-400 vac Pump.

Call For Pricing!

2-YEAR 200,000 MILE DRIVE TRAIN WARRANTY



1999 Volvo WG64T, ISM Cummins 305HP, 8LL trans, AC, double framed, 18# fronts, 40# rears on T-Ride Susp., LOW MILES, new 3360 gallon steel vac tank, new liquid cooled Masport HXL-400 Vac Pump.

Call For Pricing!

2-YEAR 200,000 MILE DRIVE TRAIN WARRANTY



IN PROGRESS

1999 International 9100, Detroit 430 HP, 10 spd, AC, double framed, new 3360 gallon steel vac tank, new Masport HXL-400 vac Pump.

Call For Pricing!

2-YEAR 200,000 MILE DRIVE TRAIN WARRANTY



IN PROGRESS

1997 Mack CH613, E-7 350HP, 10 spd, jakes, 13,200 fronts, 44# rears on Camel Back, AC, double framed, new 3360 gal steel vac tank, new liquid cooled Masport HXL-400 vac pump.

Call For Pricing!

Delivery Available Anywhere in the Lower 48!!



DRAGON PUMPS

A Modern Group Company



Custom fabrication to meet our customers specific needs in the Petrochemical, Shipping, Drilling, Agricultural and Mining industries. All Dragon pumps, agitators, hoppers and pump packages are assembled in Liberty, Texas.

All internal pump parts such as bearings, shafts, and mechanical seals are from the highest quality parts and materials made in the USA.

We maintain a huge warehouse of motors by Baldor and Reliance and starters by Sprecher & Schuh/Allen Bradley.

We also have a full stock of replacement parts for your pumps which are 100% interchangeable with other popular pumps on the market. Dragon is the largest stocking dealer of **Fruitland Pumps and Parts** in the U.S.A.

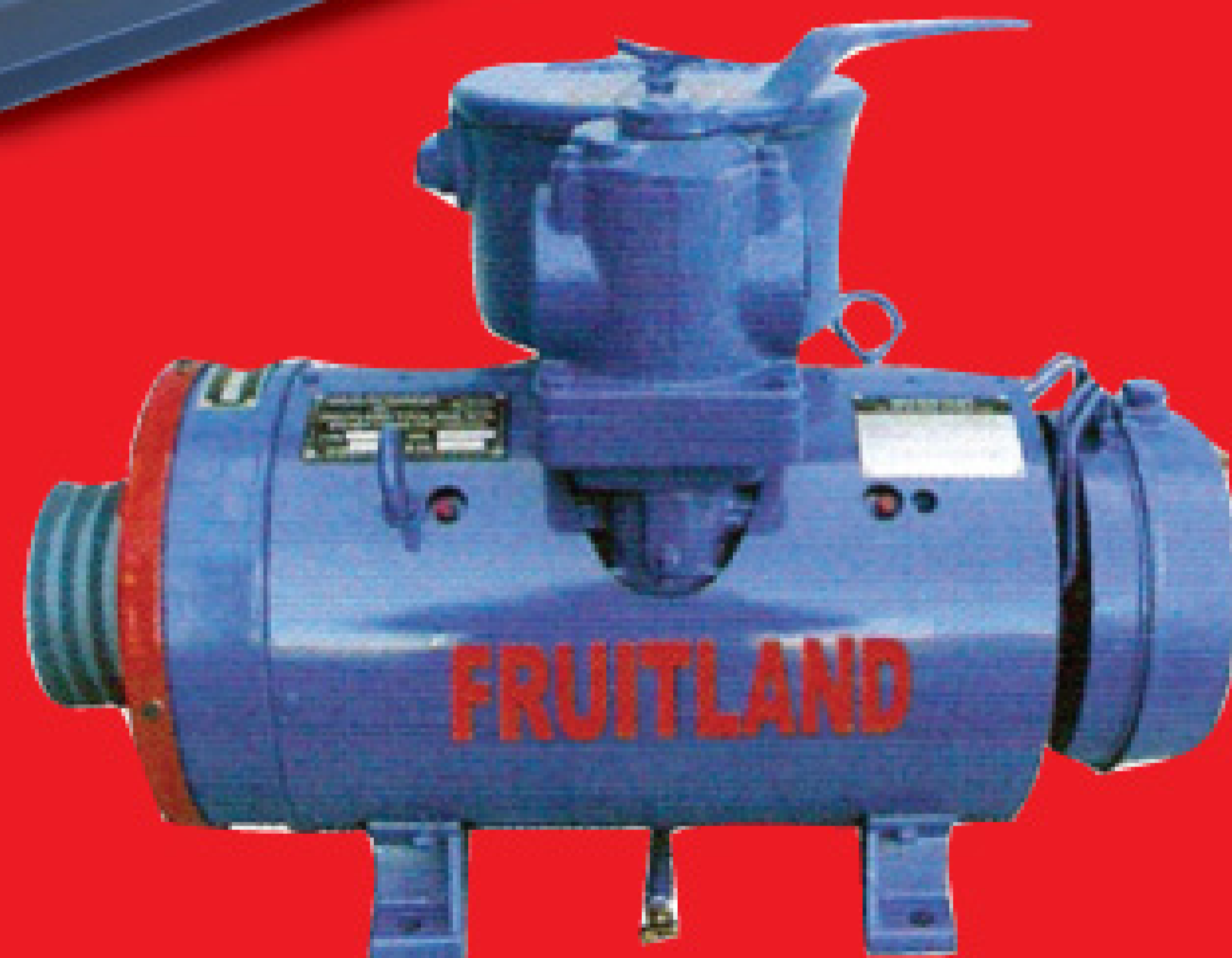

1-866-914-8198

email: sales@modernusa.com
website: www.modernusa.com

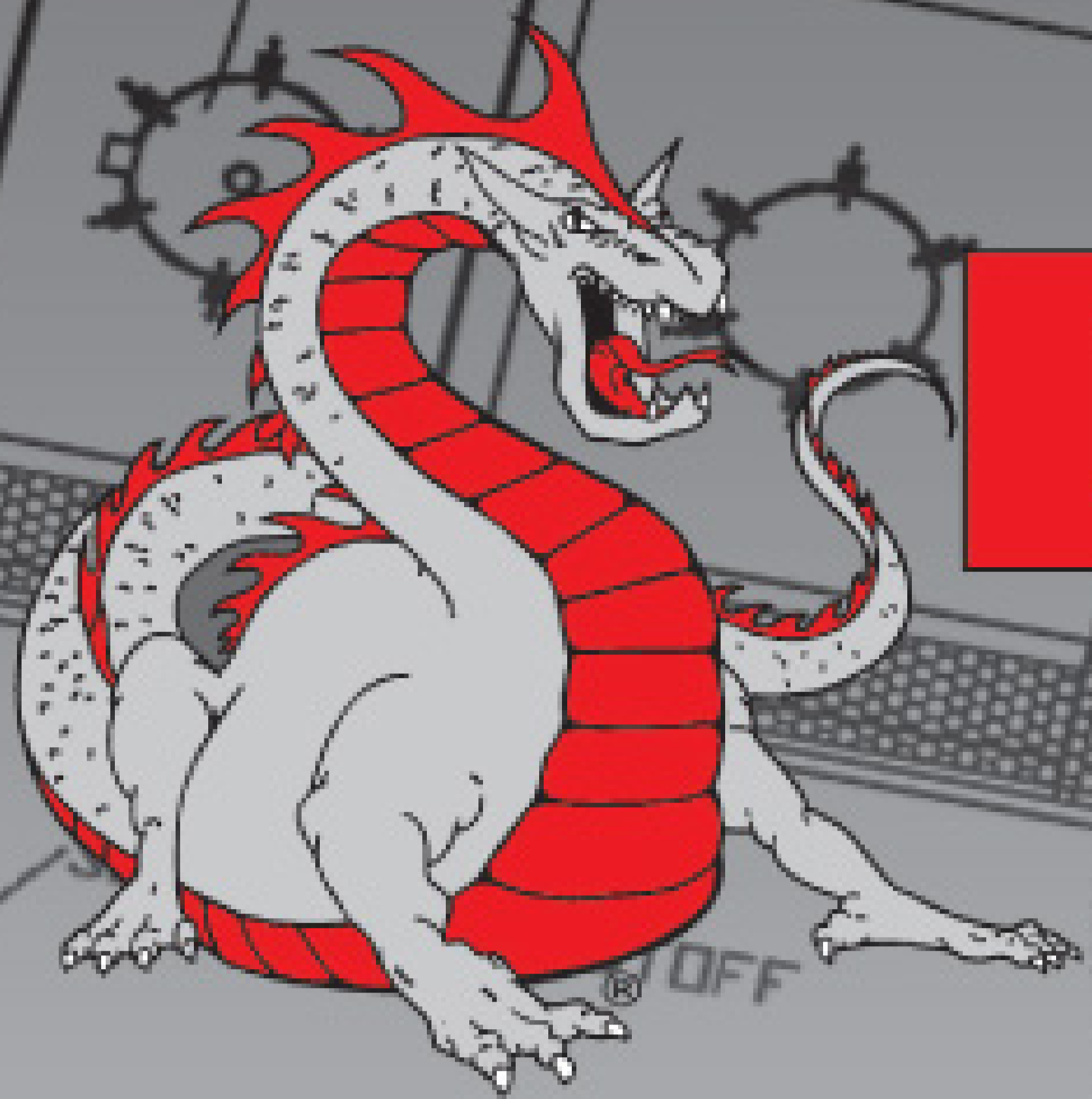

DRAGON PRODUCTS, LTD.

A Modern Group Company



30-95 BBL STEEL
& ALUMINUM
BOBTAILS



150 BBL ALUMINUM & 130-160 CARBON STEEL
& STAINLESS STEEL CODE AND NON-CODE
VACUUM TRAILERS



500 BBL
LIQUID TIGHT
SMOOTH WALL
CONTAINERS



VACUUM ROLL-OFF
CONTAINERS

Looking for Great Deals on Quality
Used Equipment.
Check out our web-site at:
www.modernusa.com

(877)778-4280

email: sales@modernusa.com



Ask about our easy
Credit Terms and
Convenient
Financing.

at the PAIN PUMP

Supply and demand issues have turned fuel prices upside down in recent months as traditionally economical diesel has trumped gasoline

By Greg Northcutt

The jaws of more than one vacuum truck driver, not to mention just about anyone else who depends on diesel-powered equipment and trucks to make a living, have dropped in disbelief as fuel prices zoomed sharply and steadily upward the past year.

From July 2007 to July 2008, the national average price of a gallon of diesel fuel in the United States soared 65 percent, from \$2.89 to a record \$4.76 before dropping by a nickel a week or so later.

Even the traditional price advantage that diesel users once enjoyed over gasoline buyers has been turned on its head. During mid-summer peak demand for many septic haulers, the average retail price of diesel was 66 cents higher than the average retail price of regular gasoline.

So what in blue blazes is going on?

It's all about supply and demand. Supplies are limited by diminished refinery capacity and areas of strife in oil-producing regions across the globe. And demand is up all over, especially China and India, which are guzzling diesel like never before as they ramp up construction and more of their citizens drive cars. And diesel demand, specifically, is growing over gasoline as the fuel of choice for autos in Europe and other countries.

And while experts say you might see a little price relief, it's not just around the corner. Fuel prices will probably never drop to where they were a few years ago, but they might slack off as supply issues start getting resolved in 2009.

A CLOSER LOOK

Appearing before a U.S. House of Representatives hearing on retail gasoline prices in May, Lucian Pugliaresi, president of the Energy Policy

"We don't see the global forces pushing up oil prices over the past four years letting up immediately ... There's always a certain degree of uncertainty in the world oil market. So many things can happen to prove us wrong."

Tancred Lidderdale



Pumper Rolfe Garrett of Robyn's Septic Service, Forest Hills, Md., fills a vacuum truck tank. (Photo courtesy of Robyn's Septic Service)

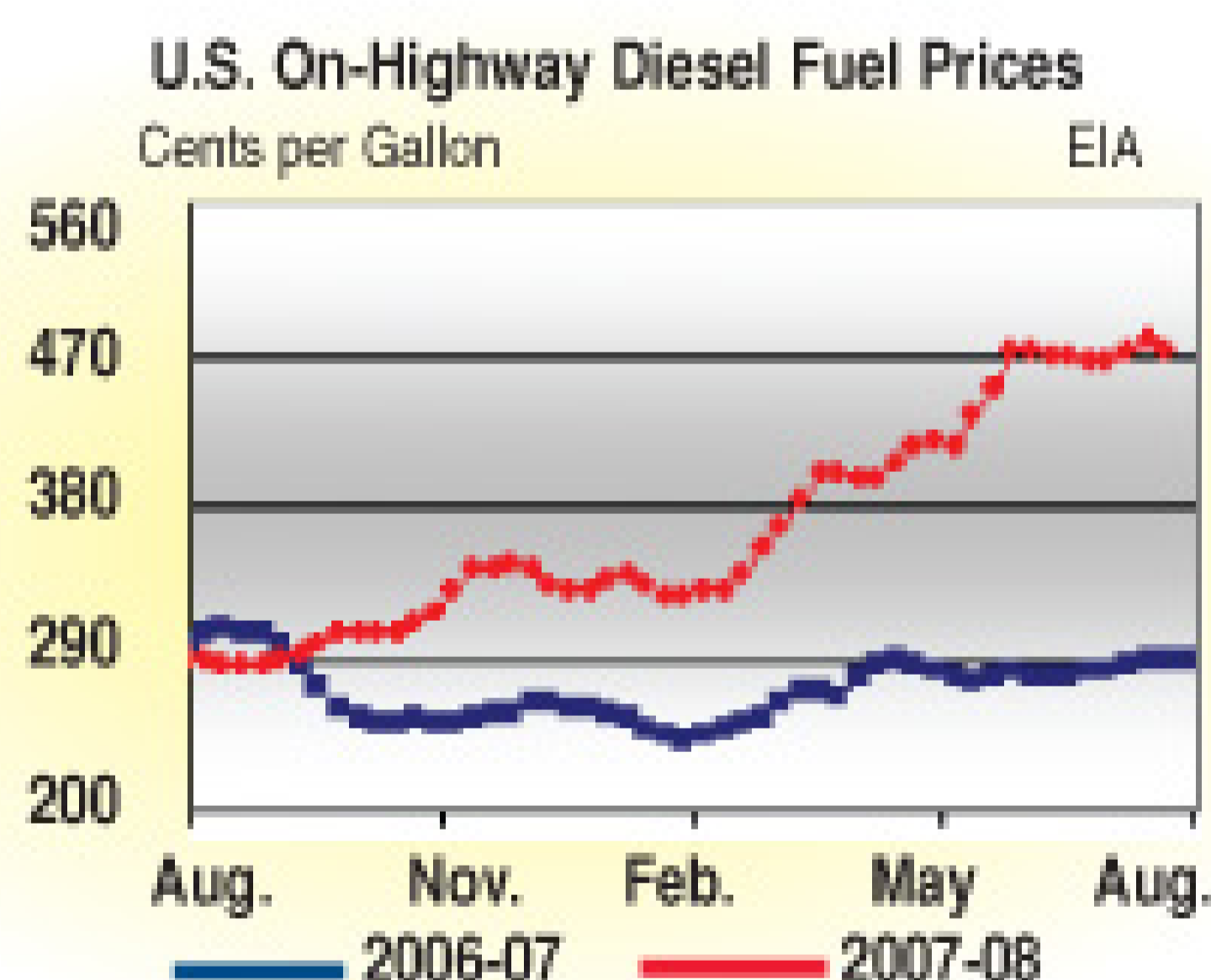

Research Foundation, stated that: "Over the last 10 years, the world oil market has clearly experienced an unprecedented number of new and sustained impediments to development. At the same time, global oil demand has grown robustly."

"It's basically a matter of supply and demand forces at work," adds Ben Montalbano, a senior research analyst for the foundation. "But, the main point to realize is that demand for diesel is being met. There have been no shortages."

If there's any other good news about diesel fuel economics, it's that analysts with the U.S. Department of Energy's Energy Information Administration, or EIA, expect the rate of increase in diesel prices — which shot up about 40 percent during the first half of 2008 — to begin tapering off significantly between now and the end of 2009. But that's barring further changes in crude oil supplies or demands — a big *if* these days.

WHY THE RISE?

Diesel is one of several middle distillates refined from crude oil. The price of No. 2 distillate, the main source of motor diesel fuel in the U.S., is affected by a number of factors. The primary one is the price of crude oil. It accounts for nearly two-thirds of the retail price of a gallon of diesel. "The rule of thumb is that every \$1 change in the price of crude results in a 2.4-

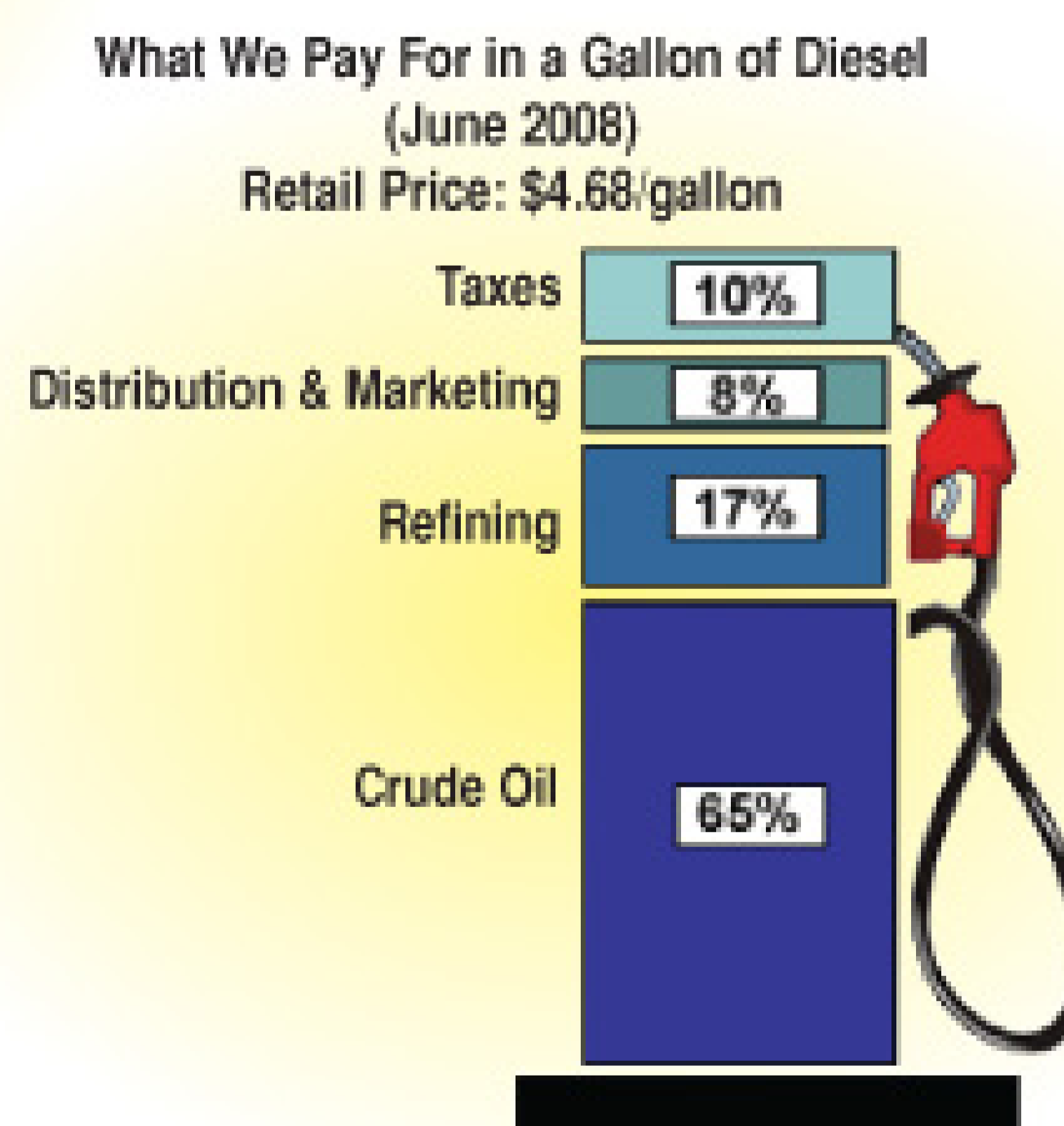

cents-per-gallon change in the price of diesel," says Tancred Lidderdale, a senior economist with the EIA.

Even then, the EIA points out, diesel prices on the West Coast tend to be higher and more variable than elsewhere in the country. That reflects higher state and local taxes, relatively few refineries (which can

lead to tight supplies and higher prices, if more than one experiences operating problems) and long distances from the Gulf Coast (source of nearly half of the diesel produced in the U.S.) and foreign refiners.

The price of crude oil, in turn, is affected by a number of other factors, as well:

Growing demand

World oil consumption continues to grow despite seven consecutive years of increasing prices, the EIA reports. Rising incomes in many areas of the world, including India and China, have increased the demand for diesel significantly. In fact, most other countries rely more heavily on diesel fuel than the U.S.

“There’s been a huge worldwide increase in oil demand, particularly in developing countries,” says Tavio Headley, staff economist with the American Trucking Associations.

This increased demand is also being fueled by other factors, Headley reports. China, for example, has stockpiled diesel to power backup generators to provide electricity for this year’s Olympic Games in the event of power grid problems. The country has been using diesel fuel to power equipment used for repairing damage in central China’s Sichuan province caused by an earthquake in May.

Government subsidies for gasoline and diesel have also sparked increased demand for crude oil. “These fuels are heavily subsidized in many countries,” says Montalbano. “In Venezuela, motorists are paying 12 cents a gallon for gasoline. In a lot of the oil-exporting countries in the Middle East, the pump price for gasoline is about 40 to 50 cents per gallon.”

However, elsewhere, he notes, countries including China, India, Indonesia, Malaysia and Nepal are starting to reduce these subsidies, which have taken a large chunk out of the government budgets.

Tight supplies

The oil market remains tight, as shown by rising prices, low surplus production capacity and concern that global supply growth may not keep pace with demand growth, at least in the short run.

Two years ago, the U.S. was consuming 20.7 million barrels of petroleum products a day, 60 percent of which were imported. Almost half of these imports came from the Western Hemisphere.

That compares to the current world supply of crude oil, which the EIA estimates at about 86.5 million barrels per day.

“The market these days is calling for just about all of that supply immediately,” says Montalbano.

What’s more, Montalbano notes, current world oil supplies are about 2.5 to 4.5 million barrels per day less than were predicted at the beginning of this decade. He attributes this shortfall to a variety of factors over the past several years. They include attacks by rebels on Nigeria’s oil infrastructure; fighting in Sudan, which has slowed development of new production in many oil fields; declining oil production in Argentina since the country’s oil sector was nationalized in 2004; forced renegotiation of contracts with foreign oil companies by Kazakhstan, which could hinder investment in oil production in that country; declining oil production since 2004 in Mexico, where lack of

funding for the country’s state-owned oil monopoly, Pemex, prevents exploration and development of new fields.

“The refining capacity for diesel and other middle distillates is just about maxed out,” says Montalbano. “There will be significant new capacity in the next two years, which might — depending on crude oil prices — ease the refining burden.”

In 2002, OPEC-member countries had an excess oil pumping capacity of 5.8 million barrels per day. Today, that number has shrunk by nearly two-thirds to around 2 million, according to Montalbano.

“Saudi Arabia has increased production twice in the past few months and fuel prices still continued to go up, partially because Middle Eastern demand for crude has risen quickly,” he says.

Risks to production

The price of diesel is also tied to the risks — both actual and perceived — of a reduction in supplies of crude or refined oil. Those risks range from war and weather-related threats to production and transportation facilities to government policies affecting development of oil resources. The higher the risks, the more money demanded by oil investors and buyers.

“These risk premiums are more of a factor than they were several years ago,” Headley notes.

In fact, the various risk factors have conspired in the past few months to cause crude oil prices to swing wildly. Over a three-day period in July, the price of a barrel of oil spiked up 8 percent from \$136 to a record \$147. The factors included fears of possible disruptions in oil supplies caused by rising tensions between the U.S. and Iran, the threat of a strike in Brazil and another drop in the value of the U.S. dollar against other major currencies. Five trading days later, the crude oil price had tumbled by almost 11 percent for the biggest one-week drop ever to \$131 as these same fears subsided.

Cleaner-burning fuels

The phase-in of U.S. Environmental Protection Agency standards to reduce sulfur content of diesel fuel, implemented in 2006, helped pressure diesel prices upward, according to the EIA. These standards required that 80 percent of on-highway diesel fuel sold in the U.S. had to be Ultra-Low Sulfur Diesel by June 1, 2006, increasing to all on-highway diesel by Dec. 1, 2010. Phasing in of clean-fuel requirements for off-highway began last year. Nearly all diesel fuel used in the U.S. must be ULSD by the end of 2014. In the meantime, the costs of preventing or correcting any contamination of ULSD with higher-sulfur content diesel and the higher costs of production ULSD could continue to influence diesel fuel prices, the EIA reports.

Market speculators

Soaring crude oil prices have prompted calls in the U.S. Congress for closer scrutiny of trading in oil futures contracts and limiting the role of speculators. Critics charge that speculators are manipulating oil prices.

As the value of the U.S. dollar has fallen, says Headley, investors have been buying petroleum futures contracts as a hedge against inflation. “The big question is how much this is contributing to the run-up in crude oil prices. The federal Commodity Futures Trading Commission is looking into the matter.”

DIESEL OVERTAKES GASOLINE

Historically, the pump price for diesel has been lower than that of regular gasoline, except during some winters when demand for heating

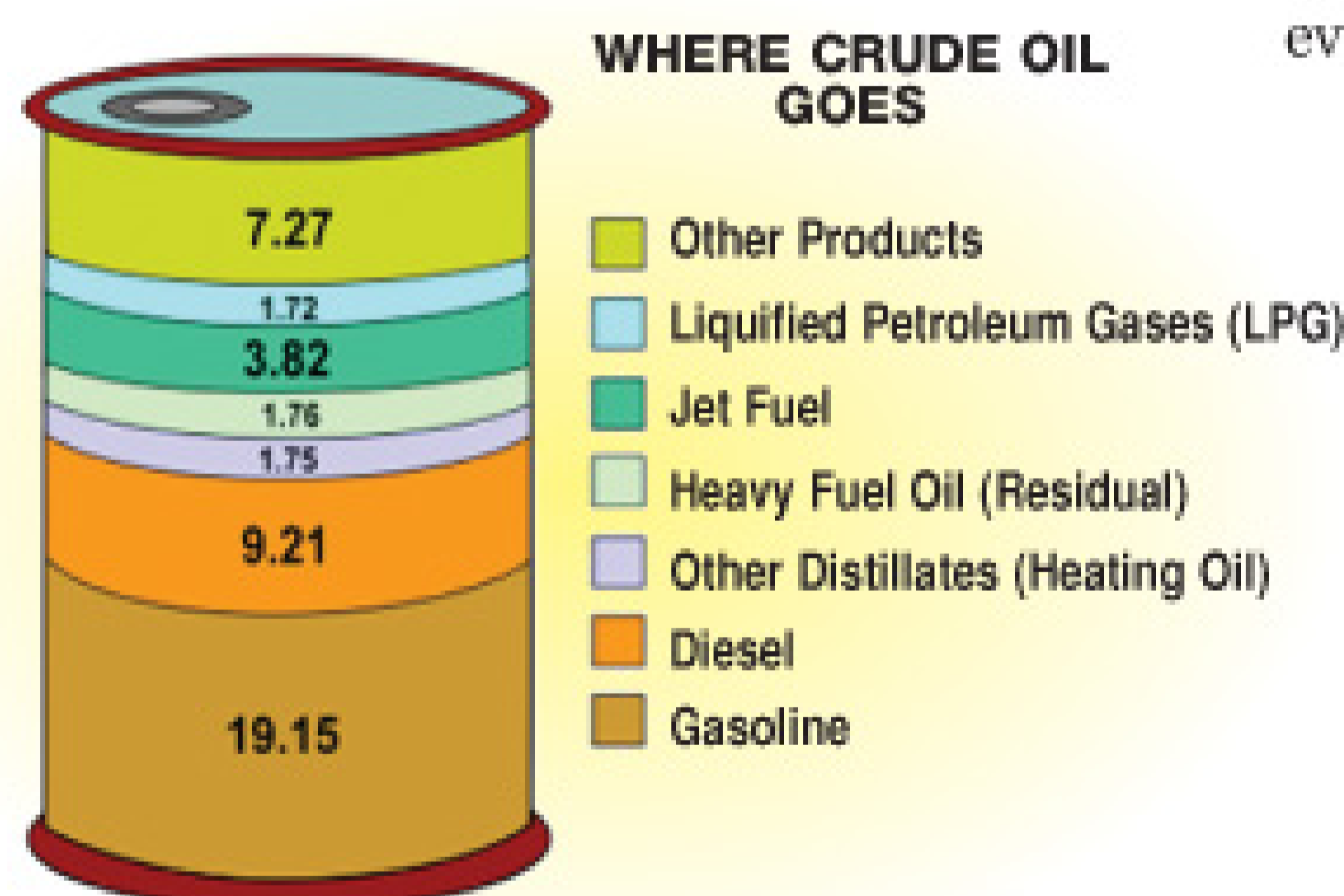

“Hybrid systems can have a major impact on reducing the more than 38 billion gallons of diesel fuel the U.S. trucking industry consumes every year — but only if our industry and government apply creative thinking to the commercialization of this technology ... Our research indicates that hybrid electric systems in heavy-duty trucks could save as much as 35 percent of the fuel consumed by conventional vehicles.”

Paul Vikner

oil was high. However, since fall 2004, diesel prices have generally been higher than gasoline prices. One reason is an increase in federal tax on diesel fuel. Another has been the steadily increasing demand for diesel around the world.

European countries, for example, have used taxes to encourage use of cleaner-burning diesel over gasoline. This has resulted in excess production of gasoline in that part of the world, notes Montalbano.

“When you refine crude oil into diesel, you also produce a certain amount of gasoline,” he says. “There’s not enough demand in Europe for all this gasoline, so they export it to the U.S. Those imports have helped keep gasoline prices in the U.S. from rising as much as they would have otherwise.”

NO SUDDEN PRICE DECREASES

As of July, EIA analysts were projecting the rate of increase in the average spot price of West Texas Intermediate, or WTI crude oil, to moderate over the following few months, peaking at \$140 per barrel in the fourth quarter of this year, before declining to \$127 by the fourth quarter of 2009.

At the same time, analysts expected a similar trend in the refinery price of diesel fuel, rising from \$3.67 per gallon in the second quarter of this year to \$4.01 in the fourth quarter. That price is then predicted to fall to \$3.53 by the fourth quarter of 2009.

In their July, 2008, *Short-Term Energy Outlook* the analysts reported, “WTI prices, which averaged \$72 per barrel in 2007, are projected to average \$127 per barrel in 2008 and \$133 per barrel in 2009. Diesel fuel retail prices in 2008 are projected to average \$4.35 per gallon, up from \$2.88 per gallon last year, and increase to an average of \$4.48 per gallon in 2009.

“We don’t see the global forces pushing up oil prices over the past four years letting up immediately,” says the EIA’s Lidderdale. These higher prices reflect strength in diesel demand, particularly in emerging markets, which has significantly increased the margins between diesel prices and crude oil costs from those of last year, the analysts noted.

Lidderdale attributes the slowing rate of price increases through the rest of this year and into early next year to increased production in the United States as two oil platforms in the Gulf of Mexico come on line and to new production in Brazil and the Siberian region of Russia.

However, he advises caution in viewing this forecast. “There’s always a certain degree of uncertainty in the world oil market,” he says. “So many things can happen to prove us wrong.” ■

Biodiesel may be a key to moderating fuel prices

In addition to common sense equipment operating practices, such as reducing idling time of diesel engines and keeping tires properly inflated, biodiesel offers an alternative for dealing with high diesel fuel prices.

Although most biodiesel is currently made from soybean oil, it can also be produced from other oil crops, such as canola, sunflower and camolina, as well as animal fats, recycled cooking oils and trap greases.

A PROVEN FUEL

“Biodiesel is one of the best-tested alternative fuels and the only alternative fuel to meet all the testing requirements of the Clean Air Act,” says Amber Pearson, with the Biodiesel Board. “Biodiesel can be operated in any diesel engine with little or no modification to the engine or the fuel system.

While some engine manufacturers continue to test the suitability of using 100 percent biodiesel, it’s typically blended with petroleum diesel fuel at concentrations up to 20 percent (B20).

Nearly all U.S. engine manufacturers accept the use of at least B5. Case, Caterpillar, Cummins and John Deere have approved the use of B20 or higher in some or all of their diesel engines, Pearson notes. New Holland supports the use of B100 in all equipment with New Holland-manufactured diesel engines, including electronic injection engines with common rail technology.

“Thanks to the June approval of biodiesel blend levels by the standard-setting organization ASTM International, engine makers will be more receptive to adding to their warranty statements higher blend levels of biodiesel, like B20,” Pearson says.

Annual sales of biodiesel in the U.S. increased from 500,000 gallons in 1999 to 500 million gallons in 2007. “Last year, biodiesel displaced about 20 million barrels of petroleum oil,” she reports.

Biodiesel is also helping to keep a lid on petroleum prices. “Earlier this year, a commodity strategist with Merrill Lynch estimated that oil and gasoline prices would be about 15 percent higher if producers of biodiesel and other biofuels were not increasing their output,” Pearson says.

HYBRID ENGINES

In January, Mack Trucks demonstrated the use of hybrid technology, which converts braking energy into electrical power in a 64,000-pound Mack truck. The vehicle was developed in conjunction with the U.S. Air Force and the Volvo Group, Mack Trucks’ parent company.

“This project has persuaded us that hybrid systems can have a major impact on reducing the more than 38 billion gallons of diesel fuel the U.S. trucking industry consumes every year — but only if our industry and government apply creative thinking to the commercialization of this technology,” says Paul Vikner, president and CEO of Mack Trucks Inc. “Our research indicates that hybrid electric systems in heavy-duty trucks could save as much as 35 percent of the fuel consumed by conventional vehicles.”

Meanwhile, diesel fuel-saving hybrid vehicles are starting to show up in construction equipment. For example, New Holland Construction, in cooperation with Kobelco Construction Machinery America Co. Ltd., has developed a prototype hybrid 7-ton hydraulic excavator and in March of this year Volvo unveiled a pre-production prototype of its L220F Hybrid wheel loader. Two months later, Komatsu introduced the PC200-9 Hybrid excavator to the Japanese market.

2009 V.E. Enterprises 'Raptor' Bobtail Tank



Why Choose A V.E. Enterprises Bobtail Tank?

Ten good reasons:

- 1. Built by ASME certified welders***
- 2. All vertical welds are sub-arc welded providing 100% penetration***
- 3. ASTM SA-36 grade 1/4" steel barrel, heads and baffles***
- 4. Barrel padded with 1/4" plate at all contact points***
- 5. 4" channel ring supports on barrel for 90, 100 barrel models***
- 6. Wider hose troughs with standard rear hose hooks***
- 7. Wedge shaped sump or loading lines with 4" butterfly valves***
- 8. Trailers prepped with steel shot blast creating a 2.5 mil anchor profile***
- 9. Primed and painted with DuPont Imron for the ultimate in durability***
- 10. Built for and by our customers; call us for available options***

** Available in sizes from 60 to 100 barrels; turn-key installations available through VE authorized dealers*

Setting the Standard For Liquid Storage and Transport Markets Since 1987.

800-234-2329

**www.veenterprises.com
sales@veenterprises.com**

10834 St. Highway 53 • P.O. Box 369 • Springer, OK 73458



ENTERPRISES, INC.



WASTE OIL RECOVERY TRUCKS



1500-5000 Gallon Cap. • Non Code In Steel • Code Available In Stainless And Aluminum



VACUUM TRUCKS



1000-4000 Gallon Cap. • Non Code In Steel • Code Available In Aluminum

OTHER PRODUCTS AVAILABLE: Fuel • Fuel/Lube • Waste Water Tanks Aluminum



435 S. 59TH AVE. #110 - PHOENIX, ARIZONA 85043

TEL: 602-233-3713 • 1-877-TWI-TRKS • FAX: 602-233-0550 • WWW.TRUCKWORKSINC.COM



MOBILE RESTROOM TRAILERS

From The Experienced Professionals at

WELLS CARGO COG



The **Comfort Elite Series** is the perfect solution for "on-site" portable restrooms and showers. Totally self-contained and environmentally friendly, the **Comfort Elite Series** is a welcome addition to any special event where demanding expectations are the norm. With the industry's shortest production lead times* and unmatched experience, the professionals at **Wells Cargo COG** will work closely with you to find the perfect solution to your mobile sanitation needs.



ADA Units



Showers



Lead Referrals



Never Look Back Warranty Program



Call: 888.574.4222

Click: www.wellscargocog.com

**Standard units usually in stock & ready-to-ship!*

Septic Tank Riser, Lid & Safety Pan™

FREE FREIGHT ON FULL CARTONS!

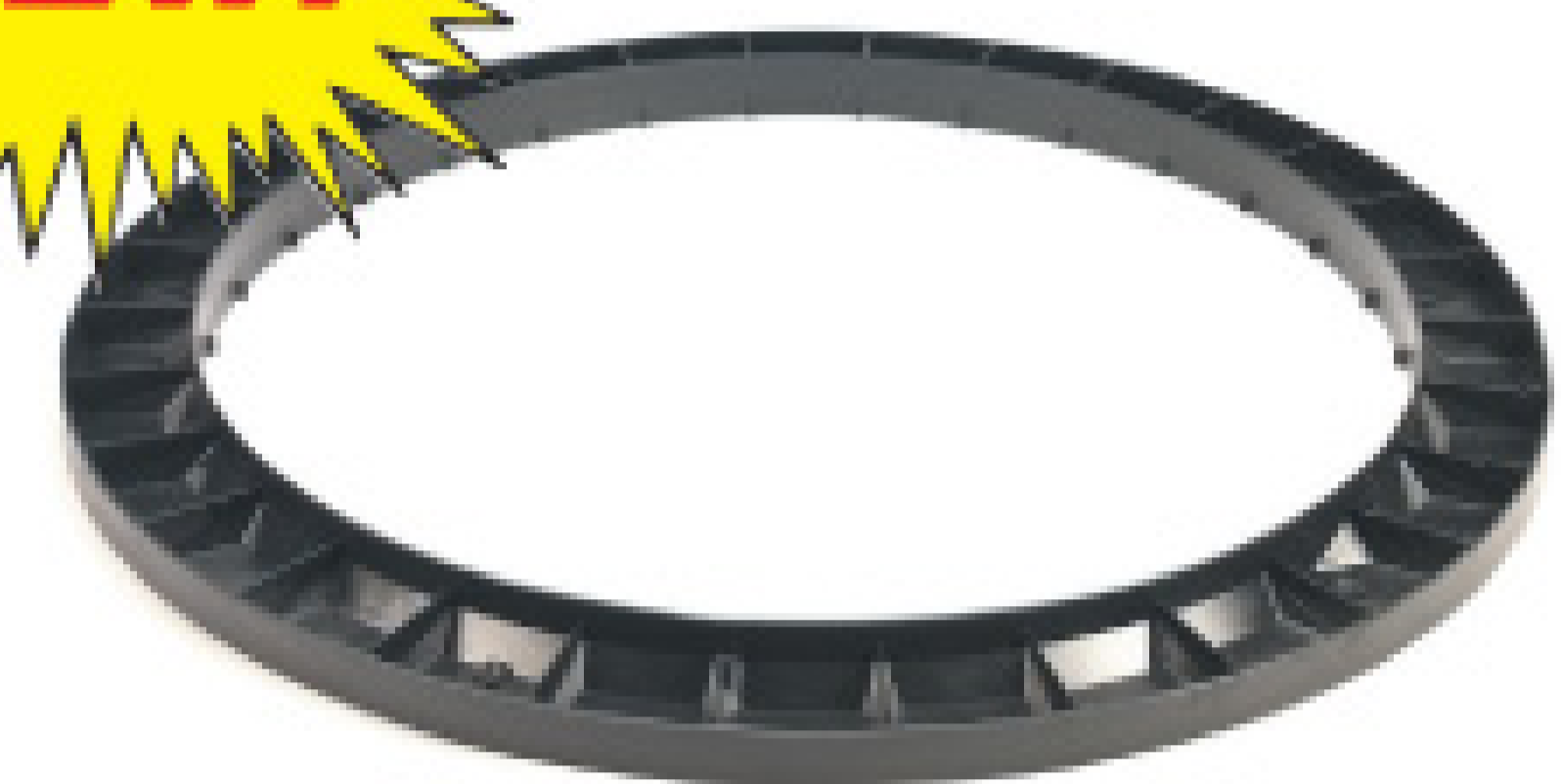

Tank Adapter Ring

New - Horizontal Safety Screw.

Safety Pan™ to Riser attachment with 6 vertical stainless steel screws.

Riser to Riser attachment with 6 vertical stainless steel screws.

Patent Numbers
5,617,679 &
5,852,901; other
pats. pending.

Riser Lid

with Molded-in gasket.
Available in 12", 16", 20" and 24" diameters.

Concrete Lid w/handle

Safety Pan™

Safety Pan™ available in 16", 20" and 24" diameters.

Riser

For septic tanks. Stackable in 6" increments. Available in 12", 16", 20" and 24" diameters.

Tank Adapter Ring

For mounting riser flush to top of tank when casting-in is not an option.

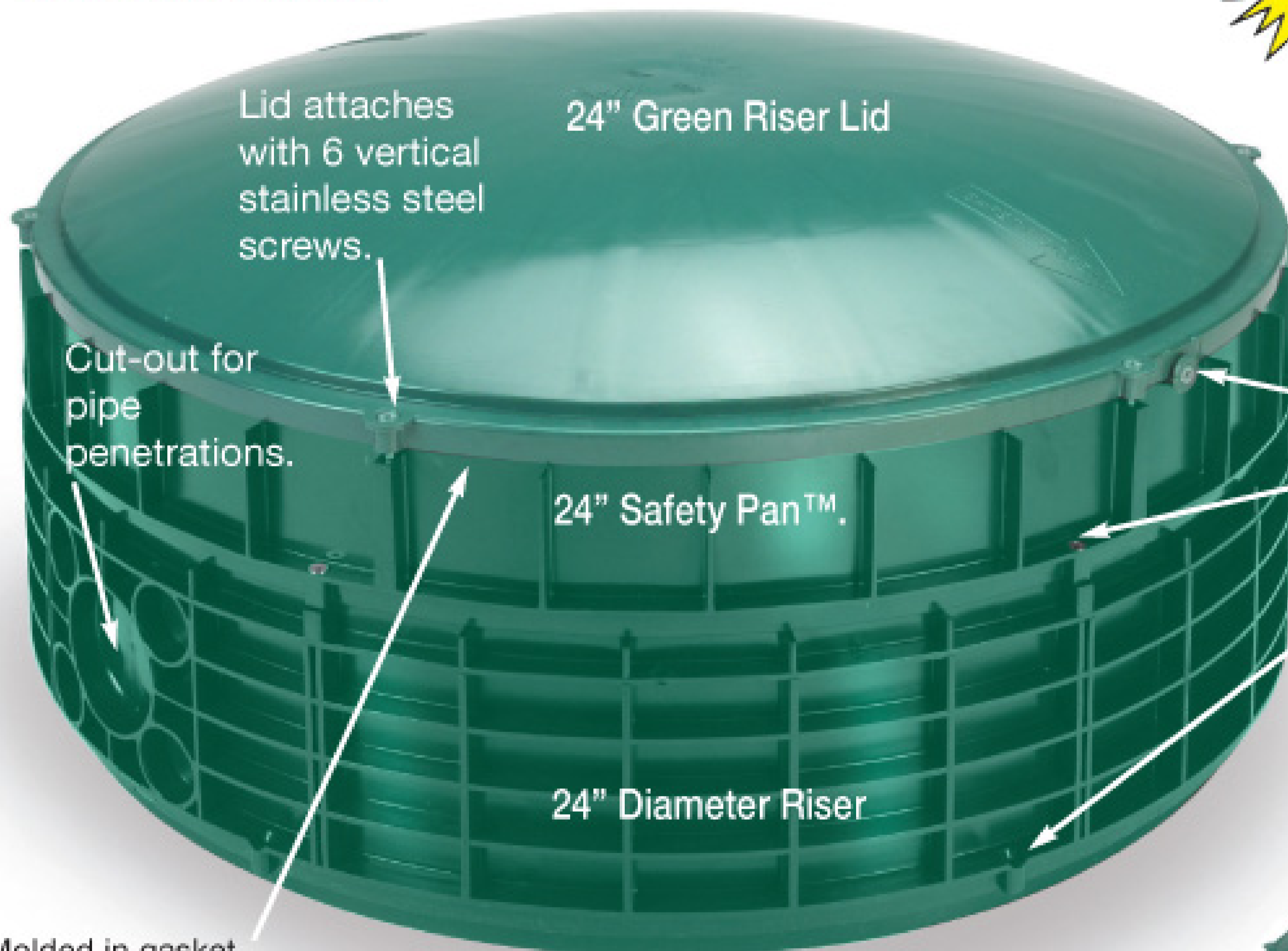

Lid attaches with 6 vertical stainless steel screws.

24" Green Riser Lid

Cut-out for pipe penetrations.

24" Safety Pan™.

24" Diameter Riser

Molded in gasket.

Available in 12", 16", 20" and 24" diameters.

Effluent Filters

Patent Numbers
6,319,403; D 431,629; other
pats. pending.

800 GPD
ANSI/NSF
Standard 46

4" Sch. 40 &
SDR-35

EF-4
4" Filter

1500 GPD
ANSI/NSF
Standard 46

4" Sch. 40 &
SDR-35

EF-6
6" Filter

Gas/Solids
Deflector

One-Piece Tank Seal

For concrete Septic tanks and D-boxes.
Accepts pipes from 1-1/2" to 4".
Mounts with or without concrete flash.



TS-4-RUBBER TANK SEAL
(will hold 10psi)
TS-4PRO TANK SEAL
(will hold 5" vacuum)



Free Freight: 32¢

Patent No's
4,951,914,
5,624,123
& 5,711,536;



12", 17", or 20"

Tested to 10" vacuum

POWER BOOSTER



Patented Technology for Pumping

PL Pressure Lift Corp

- REDUCE PUMPING TIME
- INCREASE VERTICAL LIFT CAPABILITY
- INCREASE VACUUM PUMP PERFORMANCE
- DECREASE WEAR ON PUMP & EQUIPMENT

CALL TODAY FOR A

**FREE
DEMO DVD**

**FREE Shipping
Offer Extended
(Including HI, AK & USVI)**



FREE Shipping

Pump Deeper – Pump Quicker

972.355.0550

www.pressurelift.com

Big Fish

ENVIRONMENTAL

Receiving & Processing
For
**Septage • Biosolids,
Fats, Oil & Grease**
— Turn Key Operations —

Facilities Starting at 20,000 Gallons Per Day

P.O. Box 528 • 12608 Taylor Rd.
Charlevoix, MI 49720

PH: 231.547.4429 • FAX: 231.547.2057
[www:bigfishenvironmental.com](http://www.bigfishenvironmental.com)

FULL LINE OF VACUUM TANK ACCESSORIES

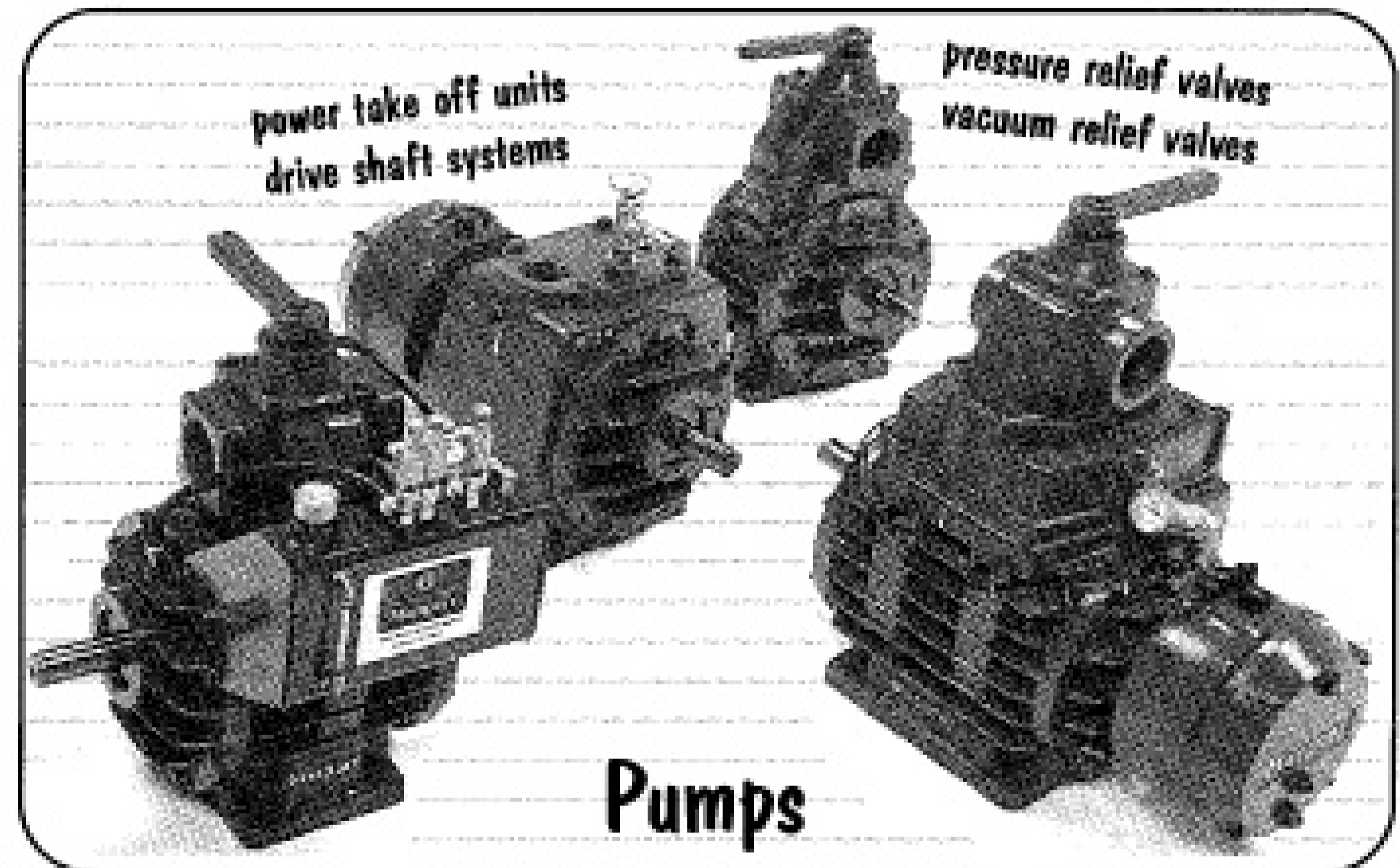

hoses
fittings



manways

For information please call Pete Burris

425-334-8263

Everett, Washington

TankTec

Tank Technologies & Supply Co. LLC
 Portable Restroom Service Trucks
 Septic, Grease & Grit Trucks
 Refined Fuel Trucks

888.428.6422



Slide-In Tanks

300 Gallon (200/100 split)
 450 Gallon (300/150 split)
 550 Gallon (380/170 split)

Aluminum Construction
 Honda Gas Motor (5.5 hp or 9 hp)
 Conde 70 CFM or Masport 106 CFM Pump
 Whale Water Pump

Completely self contained and ready to work!

PSAI Show Special! 2008 Hino 268

26,000 GVW • Automatic • Air Brakes
 2000 Gallon Aluminum Tank (1500 Waste, 500 Fresh)
 Dual Service (vacuum and water hoses on both sides)
 Masport HXL4V Pump, 160 CFM

\$82,900



Delivered to Daytona Beach Show!



Portable Toilet Service Trucks

19,000 GVW or 26,000 GVW Chassis Sizes
 1000-2200 Gallon Tank Sizes
 Flatbeds with Many Options
 Ready to Work Trucks in Stock or Build to Order

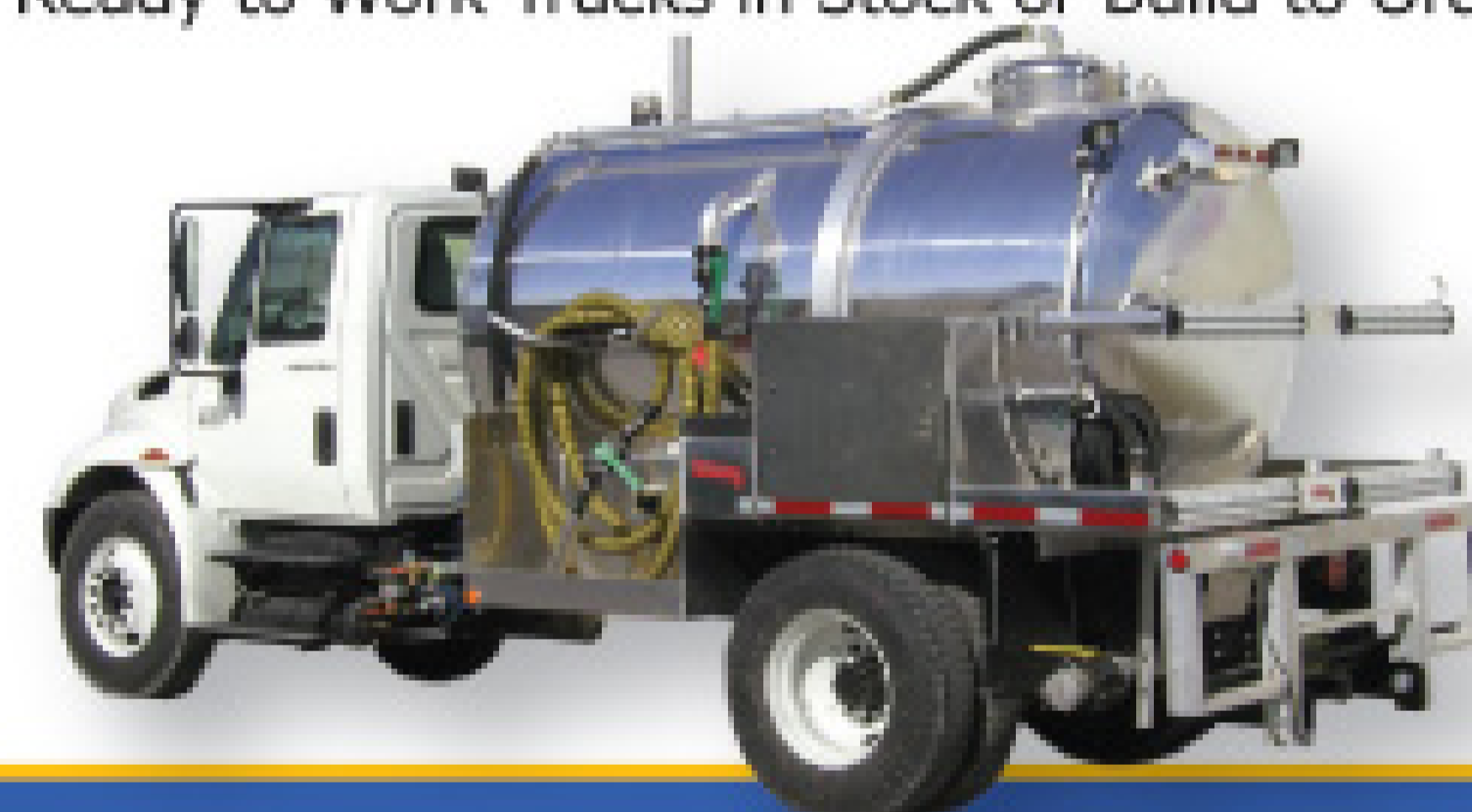

Call About In Stock Trucks

New and Refurbished Chassis

Leasing and Financing Options

Single Axle Septic, Grease and Grit Trucks

1000-2500 gallon tank sizes

No FET!



CHASSIS FROM:

Mack • Sterling • Ford • Chevy • Peterbilt
 Kenworth • International • & More!

PUMPS FROM:

Masport • MORO • NVE • Whittig
 and the NEW Robuschi Blower Pumps!

Tandem Axle Septic, Grease and Grit Trucks

3000-6000 gallon tank sizes

**Single Axle Trucks from
 \$79,000**
**Tandem Axle Trucks from
 \$104,000 plus FET**
**Financing and Leasing
 Options Available**



Ask About In Stock Trucks • Call for Lease Payment Details
 Tanks in Stock • Financing and Leasing Options Available • Dual-Use Options
 Customize to Your Needs • PRS 800-2500 Gallon • Vacuum 1000-6000 Gallon

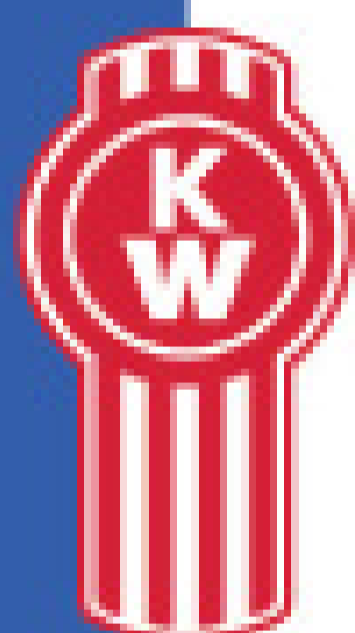

Tank Technologies & Supply Co. LLC • 888.428.6422 • www.tanktec.biz

Steve Nelson • snelson@tanktec.biz
 Andy Nelson • anelson@tanktec.biz

Local • 763.755.8075 • Fax • 763.757.9788
 10100 Quinn St. NW, Minneapolis, MN 55433

POWERFLO

PRODUCTS INC.

1-800-758-4788

Vacuum Pumps & Tank Parts at WHOLESALE PRICES!



PN58
• 252 cfm @ 18"
• Air Cooled
PN 23, 33, 58, 84, 106
IN STOCK.
\$1,380



Jurop
LC420
• 425 cfm @ 18"
• Liquid Cooled
\$2,795



R260
• 304 cfm @ 18"
• Ballast Port Cooling



RODER PUMPS
3648HBFV
OVERSTOCKED!
CALL FOR YOUR DISCOUNT!

PUMP VANES

BULLET-PROOF
your pump with
KEVLAR BLADES



DURA FLO BLADES



DC-10
Genuine Burks/Leeson Unit

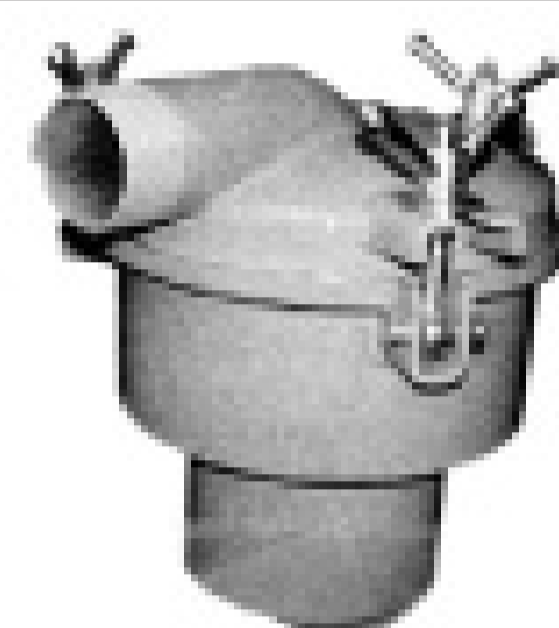

Low Pro Primary
\$295

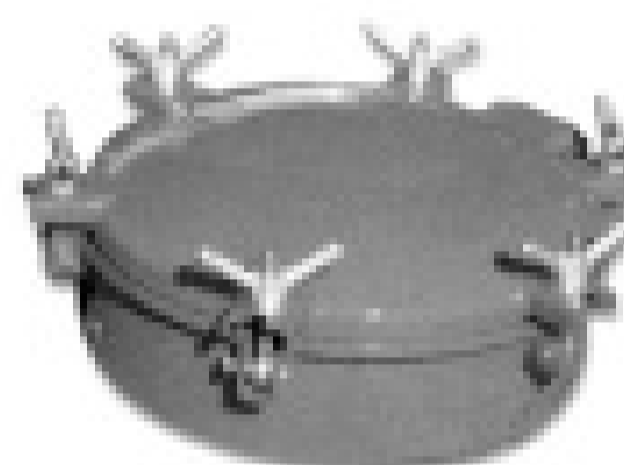

Manway Special Gasket in lid
17"
20"

Lever Action Gate Valve

Brass
3" - \$98
4" - \$157
6" - \$288



RT Angle Gearbox

1"
1 1/4"



Piston Action Gate Valve

Brass
4" - \$69
6" - \$183



POWERFLO PRODUCTS INC. • 2755 N. Gaviota Ave. • Signal Hill, CA 90806 • Phone: 562-997-0720 • Fax: 562-997-0724

SmithCo

SIDE-DUMP TRAILERS

SIDE DUMP

Call **800-779-8099**

www.sidedump.com

30902 C38
Le Mars, Iowa 51031



Manure, Slurry, Sludge, Green Waste, Food Residuals, Compost, SmithCo Hauls it All.

Stock Pile, Spread, Stability, Selection, Service...SmithCo

\$ WE'VE GOT THE MONEY \$

For All Your New and Used Equipment Needs



CHUCK TERRITO

- > APPLICATION ONLY TO 250K
- > SIMPLE APPROVAL PROCESS
- > LEASE OR LOAN OPTIONS
- > NEW & USED EQUIPMENT
- > FLEXIBLE FINANCE OPTIONS
- > START UP PROGRAMS



MIKE RAUSCH

Fax this E-Z application to **406.892.5072**, or give us a call, and we will get your financing approved for the show.

Company Name: _____ Owner/Contact: _____

Address: _____

City: _____ State: _____ Zip: _____

Phone: _____ Best time to call: _____

Let us put our 35 years of experience to work for you!

Call today and see why...

IT PAYS TO LEASE WITH US!



800.246.7997
www.graniteleasing.com

BIG *and* BRAWNY

We offer a by-the-numbers peek at the latest chassis choices for septic hauling rigs

By Ed Wodalski

The push for improved economy, comfort and performance can be seen in the latest vacuum truck chassis chosen for septic service. From hybrid fuel systems to air-ride seats and an endless variety of transmissions and suspensions, deciding on your next purchase can be a daunting task.

With diesel prices holding above \$4 a gallon, economy is on everyone's mind these days. And although the industry average for many of these workhorses is an estimated 6 mpg, your mileage could be somewhat better — or worse — depending on how and where you drive and the options you choose.





Do you climb steep hills or travel mostly level roadways? According to Kenworth, engine power settings have unique torque, horsepower and fuel-consumption curves. Selecting an engine with excessive power can lead to inefficiencies. And transmissions can impact fuel economy by 10 to 15 percent. That's why you'll want to best match your truck to the load you most often carry and terrain you travel.

If the better part of your day is spent at less than highway speeds, you might even consider one of the new hybrids. With energy tax incentives, substantial fuel savings and a "greener" marketing edge, you could find the initial investment makes economic sense over the life of your vehicle.







We contacted truck chassis manufacturers to provide us with a simple but inclusive list of facts on trucks in the 26,000- to 66,000-pound weight range. From front to back, we note engine and transmission options, tire selection, axle weights, suspension and brake offerings in a side-by-side chart.

For a more in-depth look, be certain to contact your dealer. The dealer and the company that outfits your truck for vacuum service can help determine the chassis that best meets your needs.

MANUFACTURER:	GMC T-Series Medium Duty Tilt Cab	Ford F Super Duty F-650/F-750
GVWR:	19,501 (Class 6) to 56,000 lbs. (Class 8)	17,999 lbs. to 80,000 lbs.
ENGINE:	Isuzu 6H inline-six 7.8L diesel (formerly Duramax 7800)	6.0 L Power Stroke; Cummins 5.9L ISB; Caterpillar C7 ACERT 7.2L
HORSEPOWER:	215-300	200-230 (Power Stroke); 185-260 (Cummins); 190-300 (Caterpillar)
TORQUE (lb.-feet):	560-860	520-620 (Power Stroke); 420-660 (Cummins); 520-860 (Caterpillar)
TRANSMISSION:	Allison 3000 RDS (rugged duty) 6-speed automatic; Allison 3500 RDS 5- or 6-speed versions. Eaton Fuller manual: 6-, 9- or 10-speed	Allison 5-, 6-speed automatic; Eaton 5-, 6-speed manual; Spicer 7-speed manual
SEATING:	1-3 person tilt cab, 43 inches headroom, 41 inches legroom, 71 inches shoulder room	2-3 (regular cab); 5-6 (Super and Crew); 41.3 inches headroom; 40.7-41.2 (crew) front legroom; 67.4 inches front hip room (67.3 rear crew); 68 inches front shoulder room (66.9 rear crew)
WHEELS (inches):	19.5 x 6.75 8-hole, steel or aluminum; 22.5 x 7.5 steel 10-hole; 22.5 x 8.25 steel 10-hole, steel or aluminum; 22.5 x 9 steel 10-hole (front only)	19.5 x 6.5 8-lug steel
TIRES:	245/70R19.5F to 315/80R22.5L	245/70 19.5G
FACTORY PTO:	Available	Optional
FRONT AXLE WEIGHT CAPACITY (lbs.):	10,000 to 16,000	8,500
REAR AXLE WEIGHT CAPACITY (lbs.):	15,000 to 23,000 (single); 40,000 (tandem)	13,500
WHEELBASE (inches):	128 to 260	146-260; 167-281 (super); 182-278 (crew)
SUSPENSION:	Front – single-stage parabolic taper-leaf (14,600 to 18,000 lbs.); single-stage multi-leaf (14,600 lbs. to 18,000 lbs.) Rear – multi-leaf (21,000 to 23,500 lbs); air (23,000 lbs.); RT403 or RTE403 (40,000 lbs. tandem)	Front – beam axle, parabolic taper-leaf (8,500-13,000 lb. rating); Rear – multi-leaf variable-rate leaf (13,500-23,500 lb.); air suspension (12,000-23,000 lb.)
BRAKES:	Hydraulic, 4-channel ABS, EBD standard, ABS-controlled traction control system optional; air drum standard on T8500 and optional on T7500 model	Hydraulic disc, standard ABS; optional drum air (front and rear)
FUEL CAPACITY:	50 or 100 gallons	45-160 gallons
WARRANTY:	2-year unlimited; 3-5 engine and transmission	3-year/36,000 miles; 5-year/60,000 miles powertrain
WEB SITE:	www.gmc.com/mediumduty	www.fordvehicles.com/trucks/superduty

International WorkStar 7600	Freightliner Business Class M2 112V	Hino 338 Series	GMC T-Series Medium Duty Tilt Cab
35,000-66,000 lbs.	35,000-66,000 lbs.	33,000 lbs.	
MaxxForce 11, 13; Caterpillar C11, C13; Cummins ISM	Mercedes-Benz 12.8 L MBE 4000; Caterpillar C9, C11, C13	Hino J08E-TW (turbo intercooled diesel)	
330-390 (MaxxForce 11), 410-475 (MaxxForce 13), 305-470 (Caterpillar), 320-425 (Cummins)	350-370 (Mercedes-Benz); 335-400 (C9); 305-370 (C11); 335-410 (C13)	260	
1,250-1,400 (MaxxForce 11); 1,450-1,700 (MaxxForce 13); 1,050-1,750 (Caterpillar); 1,150-1,550 (Cummins)	1,350-1,450 (Mercedes-Benz); 1,050-1,100 (C9); 1,050-1,350 (C11); 1,450-1,550 (C13)	585	
Eaton Fuller 10-, 18-speed manual; Allison HD 4560P Series automatics	Eaton Fuller manual (10, 11, 13, 18 speeds); Allison automatic (without PTO)	Eaton FS6406A (6-speed direct drive synchromesh); Allison 3000RDS (5-speed automatic)	
1-2 (high-back seats with integrated headrests); Cab: 72.5 inches wide, 58 inches high	1-3 (High-back air ride driver's seat standard; bench optional)	2-3	
22.5 (standard); 24.5 10-stud (steel); 24-inch, 12-stud (aluminum)	Accuride 28680 19.5 x 6.75 8-hole hub-piloted steel	22.5 x 8.25 10-stud steel (aluminum optional)	
11R22.5	Michelin XZE 225/70R19.5	11R22.5	
Available	Available	Optional	
12,000-20,000 (Dana Spicer)	12,000-20,000	12,000	
Single – 23,000 (Dana Spicer) 23,000-38,000 (Meritor); Tandem – 40,000-46,000 (Dana Spicer or Meritor)	23,000-58,000	21,000	
136-262	130-288	217-271	
Front – Parabolic taper-leaf springs; multi-leaf (optional); rubber auxiliary springs, air suspension (available). Rear – International, Hendrickson air, Reyco spring (single axle); International, Hendrickson air; Hendrickson, Chalmers walking beam, International multi-leaf (tandem)	Front – flat-leaf or taper-leaf. Rear – TufTrac, AirLiner, walking beam	Front – taper-leaf spring with shock absorbers; Rear – semi-elliptic main and auxiliary helper-leaf (rear); heated/non-heated shocks optional	
Bendix Air with ABS	WABCO (ABS)	Full air, dual circuit "S" cam type	
50-140 gallons	50-120 gallons	52-95 gallons	
1 year	3-year unlimited	2-year unlimited mileage	
www.internationaltrucks.com	www.freightlinertrucks.com	www.hino.com	

MANUFACTURER:	Kenworth T370/ T370 Hybrid	Peterbilt Class 8 365/367	Sterling L8500/LT 8500
GVWR:	26,001-33,000 lbs.	33,001-93,000 lbs.	37,600 lbs. (L8500); 66,000 lbs. (LT 8500)
ENGINE:	Paccar 6.7L PX-6; PX-6 Hybrid; 8.6 L PX-8	Cummins ISM, ISL; Caterpillar C9 (365); Caterpillar C13, C15; Cummins ISM, ISX (367)	Caterpillar 3126B, Cummins ISC, ISL
HORSEPOWER:	325 (PX-6); 300 (hybrid); 360 (PX-8)	280-410 (ISM); 345-365 (ISL); 335-350 (C9); 320-485 (C13); 435-600 (C15); 320-425 (ISM); 385-600 (ISX)	Cat: 175-330 (L8500), 210-330 (LT 8500); ISC: 215-300; ISL: 310-330
TORQUE (lb.-feet):	750 (PX-6); 620 (hybrid); 1,000 (PX-8)	650-1,850	520-1,000
TRANSMISSION:	Eaton Fuller FS5406A 6-speed; Eaton 6-speed Ultrashift (hybrid); Eaton Fuller 9-, 10-speed; Allison 5-, 6-speed auto	Eaton Fuller manual 10-, 11-, 13-, 15-, 18-speed; Fuller AutoShift 10-, 18-speed (365); Fuller AutoShift 18-speed (367); Fuller UltraShift 10, 13-speed; Allison automatic 4-, 5, 6-speed	Manual: Eaton Fuller Direct Drive 5-, 6-, 7-, 9-, 10-speed, overdrive 10-speed; Auto: Allison MT, MD
SEATING:	2	2	1-3 (Single driver, single driver with bench pas- senger, or no passenger). Single seats are avail- able with air ride or solid mount, high-back or mid-back lumbar support. Bench passenger seat has built-in toolbox.
WHEELS (inches):	22.5 steel (19.5 aluminum optional)	22.5, 24.5 (steel or aluminum)	7.50-12.25 (steel or aluminum)
TIRES:	Bridgestone 295/75R22.5 R250F; Bridgestone R240F 245/70R19.5 (22.5 option for hybrid)	R22.5 Bridgestone or Michelin	19.5-425/65R22.5 (Goodyear, Michelin, Bridgestone, Yokohama)
FACTORY PTO:	Optional	Available	Available with dash controls
FRONT AXLE WEIGHT CAPACITY (lbs.):	Dana Spicer 10,000; Dana Spicer 8,000-14,600	12,000-22,000	10,000-20,000
REAR AXLE WEIGHT CAPACITY (lbs.):	Dana Spicer 21,000; Dana Spicer 16,000-26,000 (single axle); Dana Spicer 40,000-44,000 (tandem)	20,000-70,000 (365); 20,000-85,000 (367)	Meritor 19,000-23,000; Dana Spicer 23,000 (L8500); Meritor 34,000-46,000 (LT 8500)
WHEELBASE (inches):	152 (minimum)	175-295	136-318
SUSPENSION:	Front – taper-leaf springs with shocks 10,000 lbs. Rear – Reyco 20,000 lbs. (single); several option- al configurations, including tandem	Taper-leaf with shocks; Peterbilt Flex Air, Lo-Air Leaf, Air Trac	Front – multi-leaf 10,000-20,000; taper-leaf: 10,000-14,600. Rear – multi-Leaf 17,500- 24,500; taper-leaf 19,000-21,000; Sterling AirLiner 21,000-23,000; Hendrickson HAS 19,000-23,000; Neway 23,000 (L8500); Hendrickson Walking Beam 34,000-46,000; Hendrickson 4-Spring 36,000-40,000; Sterling TufTrac 40,000-46,000; AirLiner 40,000-46,000; Hendrickson HAS 40,000-46,000; Neway 46,000; Chalmers 40,000-46,000 (LT 8500)
BRAKES:	Air; Bendix (ABS) hydraulic; Meritor (ABS) hydraulic	Air	Meritor-WABCO; Bendix
FUEL CAPACITY:	50-120 gallons	40-150 gallons	45-150 gallons
WARRANTY:	1 year	1 year	2 years unlimited mileage
WEB SITE:	www.kenworth.com	www.peterbilt.com	www.sterlingtrucks.com

Mack GU802	Isuzu FXR	Volvo VNM Daycab	
52,000-86,000 lbs	33,000-56,000 lbs.	35,000-60,000 lbs.	
Mack MP7-325M; numerous MP7, MP8	Isuzu 7.8 L 6-cylinder turbo/intercooled diesel	Volvo D11; D13	
300 (MP7-325M); MP7: 345-405; MP8 415-485	260 (single), 300 (tandem)	325-405 (D11); 335-485 (D13)	 <p>Kenworth T370/T370 Hybrid</p>
1,200 (MP7-325M)	660 (single), 860 (tandem)	1,250-1,450 (D11); 1,350-1,650 (D13)	
Mack TM308 8-speed; Mack 8-, 18-speed; Allison 5-, 6-speed; Eaton Fuller 9-, 18-speed	Allison 3000RDS 6-speed (single); Allison 3500RDS 6-speed (tandem)	Volvo I-Shift, 12-speed; Eaton Fuller 10-, 13-, 15-18-speed AutoShift, Ultra- Shift; ZF-FreedomLine 12-speed; Allison Generation 4 Series, 4-, 5-, 6-speed	 <p>Peterbilt Class 8 365/367</p>
1-2; Bostrom Talladega 915 mid-back air suspension (driver); Mack fixed mid-back non- suspension (passenger)	1-2 (air suspension with adjustable lumbar support)	1-2, air suspension, ergonomic seats	
22.5 x 8.25 Hayes Lemmerz 10-hole	22.5 X 8.25 (single); 22.5 X 9.00 (tandem)	22.5	
11R22.2	11R22.5G (single); 315/80R22.5J (tandem)	R22.5-20 Michelin or Bridgestone	 <p>Sterling L8500/LT 8500</p>
Available	Available	Available	
12,000	12,000 (single); 16,000 (tandem)	12,000-14,600	
38,000	21,000 (single); 40,000 (tandem)	21,000-40,000	 <p>Mack GU802</p>
192	152-236 (single); 236-260 (tandem)	175-205	
Front – Mack taper-leaf 2-leaf spring; Rear – SS38 Mack multi-leaf	Front – taper-leaf (single); multi-leaf (tandem) Rear – multi-leaf (single); Henderson Walking Beam (tandem)	Front – parabolic leaf, Hendrickson AIRTEK; Rear – multi-leaf, Volvo Air Suspension, T-Ride, Hendrickson HAS	 <p>Isuzu FXR</p>
Meritor "S" Cam 16.5 X 5 inches Q-Plus (front); Meritor "S" Cam 16.5 X 7 inches Q-Plus (rear); dual air	Hydraulic; full air (ABS)	Air	
50 gallons	50 or 100 gallons	80-120 gallons	
1 year	2-year unlimited mileage; 3-year engine, Allison transmission	1 year/100,000 miles; 3-year transmission, driveline	
www.macktrucks.com	www.isuzucv.com	www.volvo.com/trucks	 <p>Volvo VNM Daycab</p>



Kenworth T370/T370 Hybrid



**Peterbilt
Class 8 365/367**



**Sterling
L8500/LT 8500**



Mack GU802



**Isuzu
FXR**



**Volvo
VNM
Daycab**

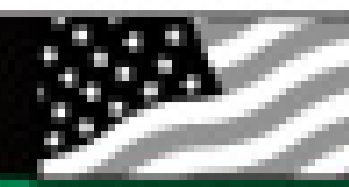

GREEN PRODUCTS SINCE 1976

The CCLS Family of septic and grease waste treatment products are—and have been since 1976—“Safe for the Environment.” It says so right on every bottle of **CCLS** and **DrainMaster** and every jar of **BIO•REM E•D**. And it's not just a slogan: it's a commitment.

Our products are not only Safe for the Environment, they actually help the environment:

- by making septic systems run properly
- by solving problems naturally and without chemicals or excavation
- by treating grease in the grease trap, where it's supposed to be treated

We have years of hands-on experience to share. All of our products and all of our programs are geared to what YOU, the septic contractor, do on the job every day.

So in an economic climate where people are trying to preserve what they have rather than replacing at a huge expense, it makes sense to maintain septic and grease waste systems the natural way, with green products from Cape Cod.

And by the way, it's no coincidence that our liquids are green in color. It's a constant reminder of our commitment to environmental excellence.

Please call us toll-free at 1-800-759-2257 to find out more about the **CCLS Family of Products** for residential and commercial septic systems, grease waste systems, and for restoring drainage. We'll send you all of our product information, including prices as well as our industry-standard customer education brochures. And no obnoxious salesman will call you (a big plus with us). Please call today and take the first step in joining the **CCLS Green Team**. Thank you.

—Rick Howe, President

CAPE COD BIOCHEMICAL COMPANY

P.O. Box 990 • Pocasset, MA 02559

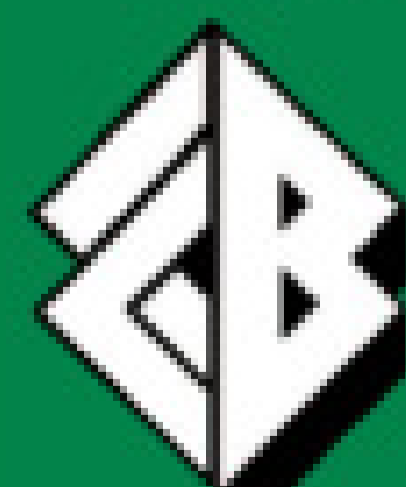

1-800-759-CCLS
(1-800-759-2257)

FAX: 508-564-9974 • www.SepticOnline.com



FACTORY AUTHORIZED SERVICE

for: **ROOTS-DRESSER, ROBUSCHI, HIBON, H&H, HOLMES and KAISER Blowers**

Fast Delivery - Large Selection - Best Price - Great Service
New - Rebuilt - Core Exchange

Exchange Units - Most Models of Roots, Robuschi, Hibon, Holmes, H&H and Kaiser

- ◆ Roots 1125 Trinidad
- ◆ Roots 1021 DVJ
- ◆ Roots 1024 RAS
- ◆ Roots 1021 RAS
- ◆ Roots 824 RCS
- ◆ Hibon SIAV 840
- ◆ Hibon SIAV 8702
- ◆ Hick Hargreaves 4084

New Blowers & Pumps Available From POWER VAC

- ◆ Roots
- ◆ Robuschi
- ◆ Hibon
- ◆ Hick
- ◆ Masport
- ◆ Moro
- ◆ Aerzen

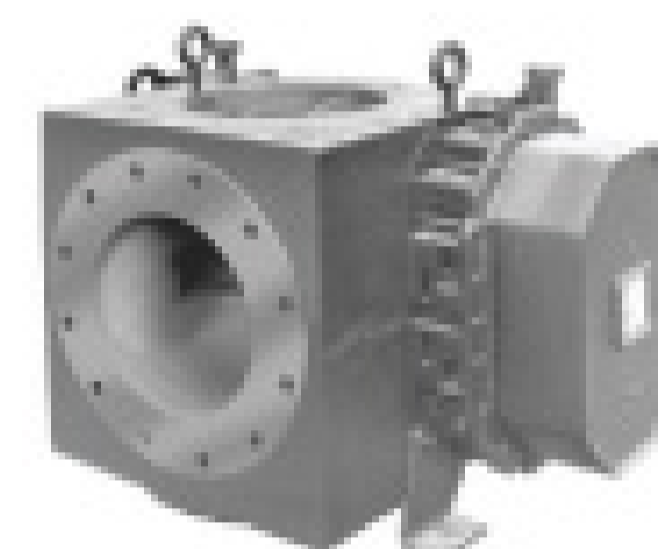

1-800-822-4887

W228 N2792 DuPlainville Rd. • Unit G. • Waukesha, WI 53186
(262) 542-8989 • Fax: (262) 542-6262 • www.powervacinc.com

MAX-LIFE Speciality Tools

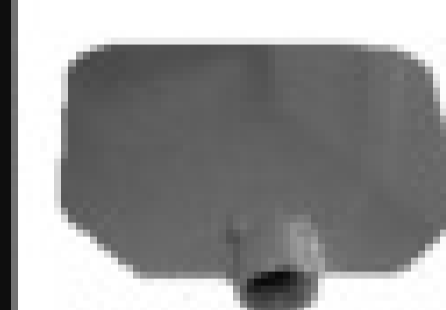

MSS-9
Sludge Spud



MDC-6RW
Grit Catchers

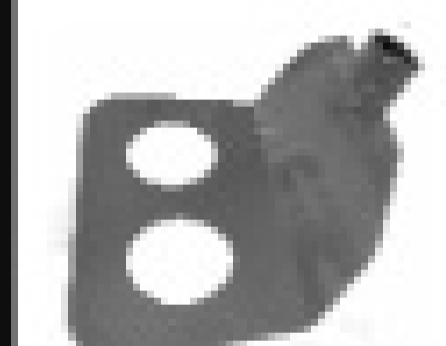

MSH-9
Sludge Hoe

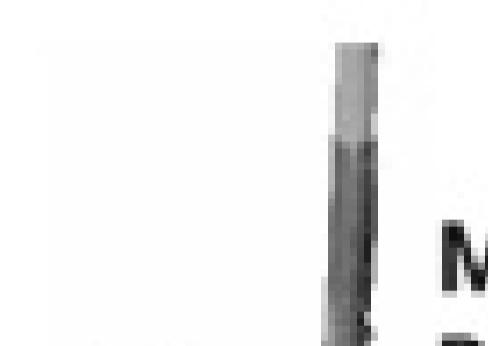

MDC-6W
Debris Catchers

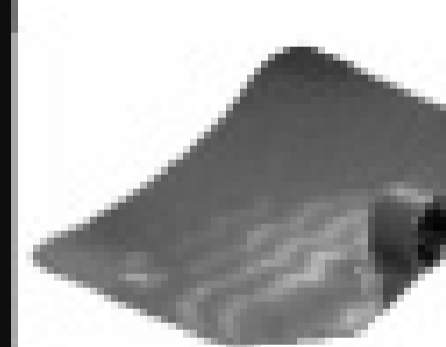

MCS-9
Curved Spud



MDT-6
Debris Traps



MHG-2
Horse Shoe Grabber



MDS-6
Debris Scoops



MBC-1
Catch Basin Spoon



MBS-6
Spoon with Fiber-glass poles



M3PG-1
3-Prong Grabber



MHC-6
Versi-Clams 6'-25'

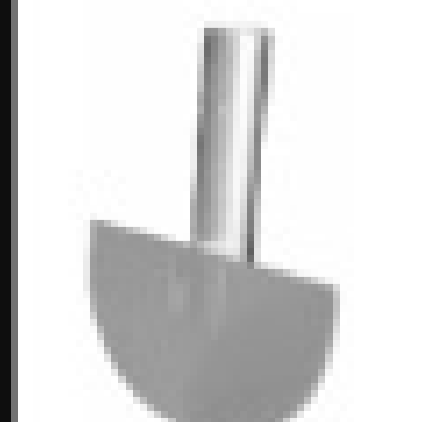

MGLC-1
Grease Log Chopper



MDG-1
5'-15' Foot Debris Grabber

MAX-LIFE MFG.

11580 Seaboard Circle, Stanton, Ca.
Tel: 888-873-6295 FAX: 714-897-2810
www.flexmax.com dhp@flexmax.com

2009 Peterbilt 340

Cummins, automatic transmission, air brakes,
Aluminum Wheels and Stainless Steel Visor

2800 Gallon *Septic Service*

Masport HXL15, Hot Shift P.T.O.,
3" Inlet, 60" Tool Box and much more!

\$103,950

As Low As **\$1,544** mo.



Not Actual Photo

RIGHT NOW! IN STOCK ... A Great Selection
of Truck Chassis, Tank Styles & Sizes.
Fast Delivery On Custom Builds.
Get yours on order today!

3800 Gallon (2) Compartment Septic Tank

Masport HXL400 water cooled
Jetter system with reel

2008 International 4400

Auto transmission

\$112,500

Plus F.E.T.

Lease from

\$1,943 mo.



LaVerne Charlet

L.C.TANKS

email: lctanks@bellsouth.net

fax: 270-898-4055

175 Cascade Dr, Paducah, KY 42003

1-888-848-3727

2008 Sterling Bullet

Cummins 305 HP, automatic transmission

1250 Gallon Tank

Masport HXL4

Dual service

Wash down

Tow package

Toilet carrier

\$69,900

F.O.B. Kansas City

Lease from **\$1205** mo.



2008 Kenworth T300 - 22,000 GVW

Cummins diesel, auto. trans., Hydraulic brakes, AC, AM/FM.

1700 Gallon 400 fresh / 1300 waste

Masport HXL 4, Burks DC-10

Hot shift PTO,

4" Discharge,

Unit hauler and

tow package.

\$77,555

Lease from

\$1135 mo.





PRECISION TANK & EQUIPMENT CO.

www.precisiontank.com | 1.800.258.4197

CENTRAL ILLINOIS Manufacturer Celebrating over 40 years of steel and stainless steel tank equipment innovations. Tank sizes from 100 to 5000 gallons in stainless steel or steel.

Manufacturing plants in Virginia and Athens Illinois allowing rapid completion of your specialty equipment!

Over 40 years of excellence! PRECISION TANK & EQUIPMENT CO.

Standard models or custom built units

Single or multiple compartments



Trailer Mounted Vacuum Tanks

Modular Vacuum Drop In Units

Vacuum Tankers

Street Flusher Tankers

1.800.258.4197

Flagg-Air Model 340

- 3450 rpm
- 1/4 hp, 115V
- Enclosed motor
- Stainless steel shaft
- High impact plastic parts
- Operates quietly
- 2-yr. warranty
- Fits in place of most original manufacturers' units
- Replacement parts available



The Flagg-Air 340 does not carry the NSF seal. Check local and state regulations for approval in your area.

MEDO HEM LA-80 Linear Pump



with low pressure alarm & light; with on & off switch

MEDO Piston



LA-60
LA-80B
LA-100
LA-120

SECOH Diaphragm



EL 60
EL 80
EL 100
EL 120



0523
1023
Rotary Vane Compressor

Regenair®

R3105-12 Blower



Hydromatic, Zoeller, ABS, Liberty & Myers Pumps

Conde SDS 6 Engine Driven



Units available 20 to 180 cfm



Moro PM80 Turbo 350 cfm
Moro Pumps: from 175 to 1642 cfm

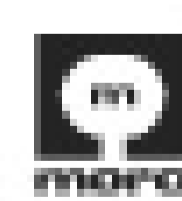

LIBERTY PUMPS

We Carry a Full Line of **LIBERTY PUMPS** and Pre-Assembled Lift Station Packages



Omnivore LSG 200 Residential Grinder



280-Series Mid-Range Effluent Pump



BIO Control Panel with Lift Station, Aerator, Timer & High Water Alarm

Myers High Head Filtered Effluent Pump



Septic Services, Inc.

toll free 1.800.536.5564 • 636.583.5564 • fax 636.583.6432
e-mail septic@fidnet.com • web www.septicserv.com





MAKE 10 TIMES MORE PROFIT

The Choice is Simple with the Aquaworx Remediator™

15 Pump Outs	x	\$150 / pump	=	\$2,250
OR				
15 Remediators & Pump Outs	x	\$1500 / install	=	\$22,500

Simply insert the Aquaworx Remediator into an existing septic tank, and in as little as two weeks, the system is restored. It works by enhancing the natural treatment process in which oxygen and bacteria work together to re-establish and maintain a clog-free septic system. Once installed, the Remediator requires an annual maintenance opportunity, allowing further growth to your business.

Easy to Install:

- No heavy equipment, hand tools only
- Tank pumping recommended
- Minimal site damage
- Total of 4 man hours

The Aquaworx Remediator is the permanent non-invasive solution for malfunctioning septic systems. Call 877-278-2879 for more information or visit www.aquaworx.com.



It's a Dirty Job ...

But the pumpers at Evans Septic Tank Service show they're proud to serve the North Dakota State Fair

By Jim Kneiszel

An appearance on a local news program's version of the Discovery Channel's popular *Dirtiest Jobs* reality show turned out to be great publicity and a pat on the back for the crews at Evans Septic Tank Service in Minot, N.D.

The Varty brothers, Sandon "Dude" and Dallas, happily agreed to have the business featured on a segment of "Someone's Gotta Do It," with reporter Clayton Clark of the Bismarck/Mandan CBS affiliate KX News. The station was visiting the North Dakota State Fair in late July and Clark accompanied Dallas Varty as he serviced recreational vehicles parked on the grounds.

Varty was happy to hand over the hose as he emptied holding tanks and explained how the job works. Evans provides 40 portable restrooms, six hand-wash stations at the fairgrounds, which is a few blocks from their yard, and services 300-400 campers parked at the fair. Evans has served the fair for eight years.

"That thing kind of stinks," Clayton said in a transcript of the segment (which you can see at www.kxmb.com/News/259499.asp). "So when I pull this out something may spill. Oh there it is. That's what fair food will do to you. I don't feel so good ... that pretty much says it all. I've scooped enough poop to earn this one."

Sandon Varty, who owns the business with a third brother, Vegas, said Dallas had a good time on the news program, and that folks around Minot mentioned seeing him on the news many times afterward. He said the lighthearted look at pumping was good for the business that doesn't do a lot of advertising, and he suggested other pumpers should consider media requests like this one.

"It's kind of like free advertising. They generally put a positive spin on things," Sandon Varty said of the humorous series of reports on tough jobs. "It never hurts to remind people that you're around. Fortunately we're pretty busy with word-of-mouth advertising."

Another nice thing is highlighting hardworking people rather than corporate leaders and celebrities all the time. Sandon Varty thinks pumpers, for example, offer an important, but largely unnoticed, service to the community.

"Nobody hears about the average guy out there getting his hands dirty on a daily basis. People don't get to see or hear about that," Varty said.

Evans Septic Tank has five employees and runs two septic service and two portable restroom trucks. The company has an inventory of 250 restrooms, mostly from Satellite Industries and Five Peaks Technology. The state fair — which attracts 250,000 people, one-third of the state's

"Nobody hears about the average guy out there getting his hands dirty on a daily basis. People don't get to see or hear about that."

population — is one of two big special events of the summer for Evans. The other is a Scandinavian festival, also held at the fairgrounds.

Sandon Varty said the reason for his family's success with the business they bought a decade ago is simple.

"Do a good job for people and they seem to appreciate it and call you back," he said.

VIRGINIA PUMPER SNARES VANDAL

Dale Wilson, owner of Wilson's Septic Tank Service in Lynchburg, Va., came to work one Sunday morning in July to find more than \$10,000 in damage to his business. Almost a dozen windshields were broken and as many portable restrooms destroyed.

Wilson had a hunch the vandals would return that night, so he hid in the shadows and waited. "The boy walked right up on me," he says. "I pulled my pistol and told him to lie down, then I sat on top of him and dialed 911." The 14-year-old was carrying the keys to all of Wilson's trucks.

Later, when Wilson saw a news report about vandalism at nearby St. John Baptist Church, he recognized a familiar mark. "It was 666, written just like the ones on my trucks," he says. Wilson contacted Campbell County investigators to report the similarities. "I told them the vandals are probably from Jefferson Forest High School, because one portable restroom was painted with JF Rules." Wilson doesn't want a reward. "Catching the boy was reward enough," he says.

CATCHING THE LOCAL HEALTH DEPARTMENT NAPPING

If you can't get your local health department to crack down on chronic failing septic system complaints, take a page from Grayson, Mo., homeowner Doug Schnath. After complaining to the Clinton County Health Department about the odor and mess coming from his neighbor's faulty septic system for eight years, Schnath called the Kansas City Fox Television "Problem Solvers" team.

Schnath and his tenant Sue Phelps called the Fox 4 news team and showed them the spot where septage was bubbling to the surface in their neighbor's yard. The video account can be seen at www.myfoxkc.com, showing what Schnath and Phelps plead has to be a health code violation. The pair argued that system should have been repaired years ago.

Cut to a defensive Marsha Downs, director of the county health department.

"We've been working on this for a number of years and there have been promises that it will be done. We've become negligent not to keep on them constantly," she says in the understatement of the year.

Is a Missouri onsite system installer in line for a new job? The Fox news channel promised to follow up and make sure the failing system is addressed.

— *Scottie Dayton contributed to this report.* ■



Pumper welcomes letters from readers responding to articles we publish or offering comments and opinions of interest to the industry. You can submit your letter by:

MAIL: Pumper, P.O. Box 220, Three Lakes, WI 54562
FAX: 715/546-3786 ■ E-MAIL: editor@pumper.com

All letters must be signed. Please limit your letter to 500 words or less. We reserve the right to edit all letters for length and clarity.

**2005 CX613 MACK
REFURBISHED CHASSIS
DRIVE TRAIN WARRANTY
New! Tank & Pumping System**

Stock #6545

2005 Mack Vision CX613 -
Refurbished

New! Progress Aluminum Vacuum Tank
4,000 USG - Non-Dumping
Moro PM100 Vacuum Pump (460 CFM)

\$112,485

**Lease Financing Payments
As Low As... \$1940 mo.**



Stock #6685

2005 Mack Vision CX613 - *Refurbished*

New! Progress Carbon Steel Vacuum Tank
3,400 USG (80 Barrel) Non-Dumping
Moro PM100 Vacuum Pump
(460 CFM)

\$101,995

**Lease Financing
Payments
As Low As...
\$1759 mo.**



Stock #6559

2005 Mack Vision CX613 - *Refurbished*

New! Progress Aluminum Vacuum Tank
4,000 USG *Full Rear Opening Door and Dump Hoist*
Moro PM100 Vacuum Pump (460 CFM)

\$126,975

**Lease Financing
Payments
As Low As...
\$2190 mo.**



Not actual photo

Rental Units Available...ask for details.

**ON-THE-GROUND!
Immediate Delivery!
Lease Financing**

Refurbished Chassis Specifications:

- 2005 CX613 Mack
- 330 H.P. Mack engine
- 10 speed transmission
- 14,000# front axle
- 40,000# air ride rear tandem
- Double frame



These Mack chassis have undergone **extensive refurbishment** including:
Front axle: New king pins, bushings & brakes.
Engine: New rod & main bearings & rear main seal.

- New clutch
- Rear suspension: New bushings and brakes.
- New virgin tires.
- New paint.

Includes a 'limited drive train warranty' for 30 days and an optional 12 month 100,000 mile drive train warranty for an additional \$4,800

www.amigotruck.com

800-800-7575

Charlie McDaniel

Cell: 713-539-0055

charlie@amigotruck.com



**Amigo
Truck LTD.**

710 McCarty Drive

HOUSTON, TX

Juggler™



labrie
environmental group

ISO
9001
CERTIFIED
(2000)



☎ 1 800 463-6638 | www.labriegrup.com

Or contact Robert Lamarche at ☎ 1 514 919-0347

Log on to our website to watch the new Juggler video!

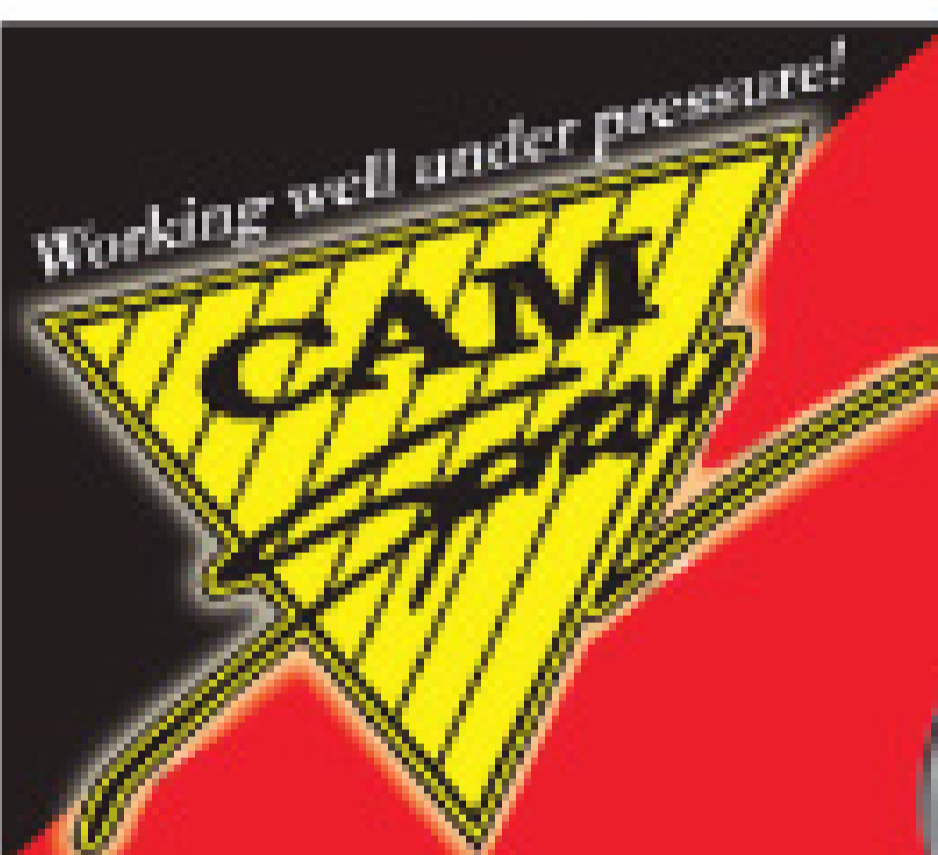

GET MORE JETTER FOR YOUR DOLLAR!

We include
features that
others only
offer as options!



STB2511H-MAX

Full Featured Jets with Powered Reels:

SK4007V 23 h.p. Briggs 7GPM @ 4000 PSI... \$10899

STB2511H 24 h.p. Honda 11 GPM @ 2500 PSI... \$12499

SK3012K 29 h.p. Fuel Injected Kawasaki 12 GPM @ 3000 PSI... \$15699

STB3015V 35 h.p. Briggs Vanguard 15 GPM @ 3000 PSI ... \$19595

STB4018DT 49 h.p. Hatz Quiet Diesel 18 GPM @ 4000 PSI... \$39950

Trailer Models starting at \$8595

www.camspray.com

800-648-5011

Money Talks...

and you should too. Tell your customers about **Pro-Sept**, a new warranty program exclusively for residential septic systems.

Word of mouth can earn you money!

Just refer your customers to us, and every warranty written as a result, earns you cash. It's that simple!

Pro-Sept offers customers:

- Up to \$25,000 for septic repair or replacement
- \$500 deductible
- 3 or 5 year term
- Transferrable to new homeowner if home is sold.

Call us TODAY to get started.

Pro-sept™ Septic System Protection Plan

888.999.5208

353 Candlewood Lake Rd., Brookfield, CT 06804 · www.powderhornagency.com



800-367-0972

Treat yourself &

Call the professionals at WESTMOOR LTD
for ALL your pumping needs.



Activator

EASILY Switch between Vacuum & Pressure



Right angle drive

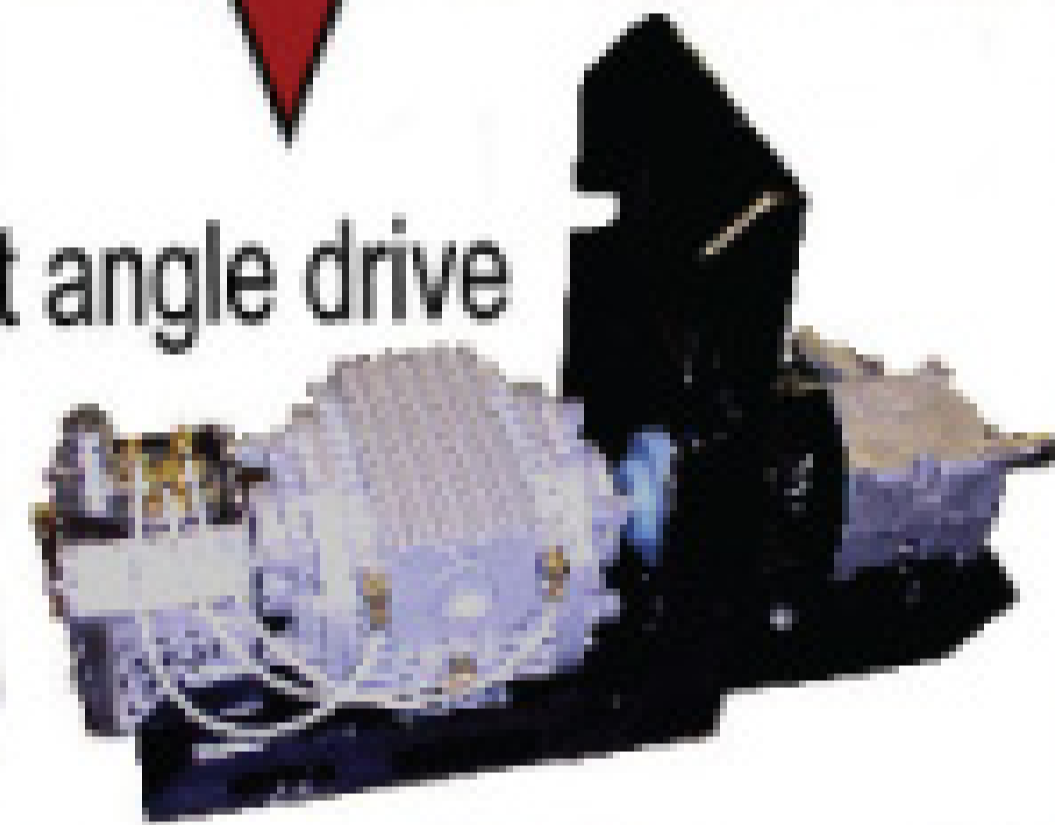

This innovative feature works with the Conde Slide Valve for remote switching of the pump between vacuum & pressure.

- for use with Super & SDS model pumps
- can be used on any pump/drive configuration
- compact size for mounting almost anywhere
- easily retrofit existing pumps

Diesel Units



Pumps

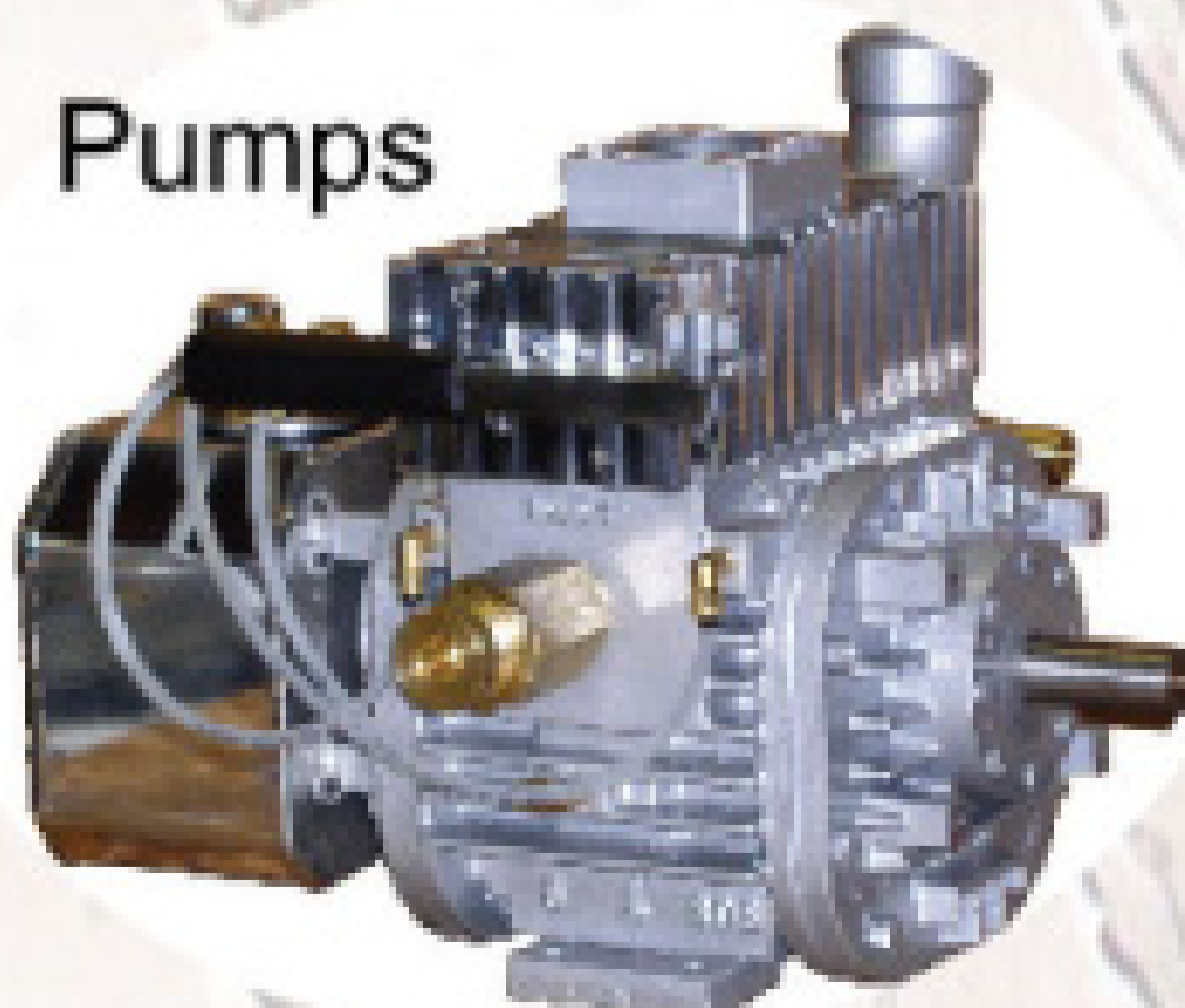

Gas Units



Pro Vac
Grease Trap Unit



Built Better to Perform Better™



Compact, heavy duty vibration-resistant hose reels

Military tested, innovative

Rely on Reelcraft's new dual pedestal Series DP7000 for greater resistance to vibration: it meets or exceeds military Vibration for Truck Transport testing.* Compact and strong, it is engineered for the most demanding vehicle-mounted applications.

*MIL-STD-810F, 500,000 mile equivalent.

NEW

Dual pedestal reel ideal for washdown, sanitizing



Patent Pending Series DP7000

Jetter reels

Reelcraft's large frame jetter reels are designed for various high pressure applications that require the added strength and stability of a heavy duty frame and spool assembly.

NEW

Jetter reels built to your specs
Nordic Series



800-444-3134
reelcraft.com/pumpercleaner

REELCRAFT

Wind Things Up With Reelcraft™



JAG is the Fastest Growing Mobile Restroom, Shower Trailer, Custom Trailer Manufacturer. To Hear Why, Ask Any JAG Owner

- Qualified Referrals
- Constantly Rotating Inventory
- Solar Packages
- Interiors from Functional to Fantastic, Industrial to Commercial



Mobile Restrooms • Shower Trailers • Custom Combinations



(800) 815-2557
www.jagmobilesolutions.com



SOFTWARE FOR THE INDUSTRY



GET A LIFE!

...with software that will get your life back!

Summit™ XP Service Profit Builder™

Work Orders
Job History
Reminders
Diagrams
Dispatching
Instant Mapping
Inventory Control
Receivables
Commissions
Repeat Business
QuickBooks® Link
...and much more!

Easiest to use!
...Over 25 years experience

Let us transfer the data from your old program!
Stay on Top...with Summit™!

Ask about our other software programs for:
-Portable restrooms & other rental businesses
-Sales contacts for sales personnel
-Employee incentive tracking
-Fleet maintenance and service tracking

DEMOS ON LINE!...or call for a Demo DVD or personal guided tour



Ritam Technologies, LP

Sales: USA 800-662-8471 • Int'l: 208-629-4462
Email: info@ritam.com • Web: www.ritam.com

Write-Off Your Next New Pumper!

The Economic Stimulus Act of 2008

Allows Up To **\$250,000**

To Be Expensed In One Year.

Contact your tax professional for details.

The One **Year-End SPECIAL!**
You Can't Afford to Miss!



2009 Peterbilt 340 Cummins, automatic transmission, air brakes, *Aluminum Wheels and Stainless Visor (not shown)*

2800 Gallon Septic Service
Masport HXL15, Hot Shift P.T.O., 60" Tool Box and much more!

\$103,950 As Low As **\$1544 mo.**

2008 Kenworth T300 22,000 GVW
Cummins diesel, auto. trans., hydraulic brakes, AC,
1700 Gallon 400 fresh / 1300 waste
Masport HXL 4, Burks wash down, Hot shift PTO,
4" discharge. Unit hauler and tow package.

\$77,555 Lease from **\$1135 mo.**



2008 Sterling Bullet
Cummins 305 HP, automatic transmission
1250 Gallon Tank

Masport HXL4, dual service,
wash down, tow package
& toilet carrier.

\$69,900

F.O.B. Kansas City

Lease from **\$1205 mo.**



2007 Ford 550 800 Gallon 300 Water / 500 Waste
Masport HXL4 pump, Burks DC10
Thieman 1,500lb. liftgate.

\$71,725

Lease from
\$1434 mo.



Guaranteed Credit Approval!

- ✓ **Competitive Rate Financing!**
- ✓ **New Start Up Operators...OK!**

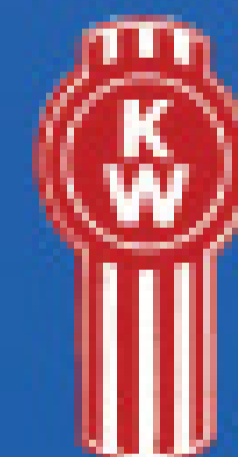

KeeVac

Industries Inc.

1835 W. Union Ave., Unit 1, Sheridan, CO 80110

NOT just a another broker.

We are a **Complete Sales & Service Center**
Offering more than 50 years service experience.



Kevin Keegan
32 Years Experience

Call Kevin. Call Matt. ...Just Call KeeVac

866-789-9440

www.keevac.com



Matt Crowell
18 Years Experience

PORTABLE TOILET
SERVICE UNITS
SLIDE IN UNITS
HOISTED UNITS
ROLL OFF UNITS
CUSTOM UNITS

www.pikrite.com

pikrite

Manufacturing & Sales - 60 Pik Rite Lane - Lewisburg, PA 17837

1-800-326-9763



- ◆ We are an authorized distributor of **Amthor International** steel, stainless steel and 5/16" aluminum vacuum tanks.
- ◆ Numerous units ready for immediate delivery with customized financing and leasing packages
- ◆ **Three locations** to serve you better with a knowledgeable sales staff
- ◆ **Full line of pumps** including Masport, Moro, Chandler & NVE for all your pumper needs
- ◆ Carrying the finest **GPS navigation & Fleet management systems** on the market today. Cost effective, no hidden fees and a quick ROI
- ◆ Signal Trac Ultra is a fleet management application with support for a variety of tracking devices and terminals. Track, communicate, dispatch and document your fleet activity with Signal Trac Ultra's integrated feature set.
- ◆ *SmartAntenna* is the industrial strength solution for GPS fleet tracking; it only transmits quality data. Algorithms eliminate GPS drift, determine idling, detect movement, calculate mileage and filter through GPS readings to select the best.

Visit us at the



Booth
14028 &
14029

ADVANCED
TANK SYSTEMS
MD. & PA.

TANK SYSTEMS
MD. & PA.



SIGNALTRACULTRA
BY ADVANCED
TANK SYSTEMS INC.



Contact Tim Albert today

**ADVANCED
TANK
SYSTEMS INC.**

MD: (410) 752-5411, PA: (215) 822-1336,

DE: (302) 398-3253

E-mail: timalbertats@verizon.net

BIODEGRADABLE DEODORIZERS

Our Environmentally Friendly line of deodorizers provide you with unsurpassed quality at a price that works for you.



Choose from our traditional liquids,
portion control tablets or liquid packs.
You will use less product and save more money with J&J.



Call our customer service team for more details.

1-800-345-3303
www.jjchem.com

J&J East - Athens, GA | J&J West - Moab, UT



Carol Coddington, in her garden of lilies, combines her gardening expertise with the knowledge she gained running a septic pumping business with her husband, Keith, to advise readers of an online gardening forum about what to plant over a septic tank.



A Growing Hobby

Central Pennsylvania gardener shares septic tank knowledge with other flower enthusiasts

When Carol Coddington saw a question posted on an online gardening forum about a septic tank problem, she jumped right into the conversation. After all, septic tanks and gardening have filled her work and leisure hours for years, and if anyone was qualified to educate the alarmed gardener who couldn't locate her septic tank, feared having it pumped and wondered what could be planted near it, it was Coddington.

"I feel I have to reply, because my husband and I just sold our septic tank truck," Coddington wrote to her fellow gardener. "Don't EVER be afraid of a septic tank. You just have to learn how to do things correctly."

During the years that she and her husband, Keith, operated K and C Septic Service in Huntington County, Pa., Coddington handled office duties and occasionally rode along on service calls, but she still managed to spend at least an hour a day in the garden when the weather cooperated.

"I've gardened my whole life," says Coddington, 59. "I remember helping my mother in the garden when I was a little girl."

Keeping up with both the garden and the septic business was often a challenge since peak season for both activities somewhat coincides.

"My busiest time was when I sent the bills out every month," Coddington says. "I made a point of having them out the same day every month and I made sure that was done before I did any gardening."

"After that I could take the phone out to the garden and get some gardening done without missing any business calls," she adds. "But still, things in the garden would always get ahead of me."

Not this year, though. The Coddingtons sold their 150 portable restrooms in 2006, their septic truck in late 2007 and officially retired. The garden is now job one, and the phone can stay inside.

"Now that we're retired I can spend even more time in the garden," Coddington says.

And she basically started that garden from scratch this year, moving plants from the yard of the 1860s farmhouse to the yard of the new house the Coddingtons built on a different part of their 200-acre central Pennsylvania farm.

"We've always lived in old two-story houses with old house issues like the floors that weren't level and outlets that wouldn't work," she says. "We decided that when we retired we were going to live on one floor and have everything brand new for a change."

Everything brand new, except the flowers.

"We rented out the farm house and I told the renter, 'you can plant things in the garden, but I'm moving the flowers,'" she says.

While Coddington puts in a few annuals, most of her flowers are

perennials. Some, like calla lilies, dahlias and gladiolas, she digs up and brings inside, then replants in spring because they aren't cold hardy. Her favorites, however, are irises and lilies, which can tolerate the winters.

"I love bright colors and I love the smell of lilies," she says. "Everyone is a sucker for certain things. With my daughter it's shoes, with me it's flowers. I'm a sucker for flowers. If I get money for my birthday or Christmas, that's where it goes. I've probably spent thousands on flowers, which is why I brought them with me when we moved. Plus, it was good to move then ... it thinned them out."

Coddington is by no means a flower snob, admitting she likes to rescue plants from what she calls the "almost dead" shelf at home improvement warehouse stores.



Keith and Carol Coddington's youngest granddaughter, Athena, sits among the lilies and irises in Carol's garden. When the Coddingtons operated K and C Septic Service in Huntington County, Pa., Carol would take the phone into the garden with her. Now that she's retired, she only takes her grandbabies with her.

Carol Coddington's Tips for Gardeners and Septic Tank Owners

Combining her experience in the septic business with her love of gardening, Carol Coddington — the “C” of the former K and C Septic of Alexandria, Pa., came up with some tips pumpers might pass along to their green-thumbed customers:

- It's OK to plant flowers over the septic tank, but don't make the bed so big that the septic man has no choice but to step in it or drive on it and ruin your flowers.

- Don't have trees growing around the septic tank because trees will seek water and send roots toward the septic system lines and eventually break through them. The septic system is an endless source of nutrients for them.

- After you find the tank, have your pumping professional add a riser. That way, the next time it needs to be pumped, you won't have to dig up all your plants and flowers again.

Plus, some general hints Carol believes should be passed along to every household with a septic tank ...

- Don't overuse your water. Don't take marathon showers. Don't do all of your laundry at one time. At least wait an hour between loads, and better, don't do more than three loads in one day.

- Make sure your well is nowhere near your septic tank. You would not want the drinking water to get contaminated.

- Do not flush garbage, household waste or feminine products down the toilet. And toilet paper is not all the same. Buy a few different brands, tear off a piece of each and put it into a glass of water and see how long it takes to dissolve, if it dissolves. All things are not biodegradable.

- Most importantly: Have your system pumped on a regular basis ... listen to your professional pumper for the proper service interval. “We haven't pumped in 30 years and we've never had a problem,” are words a pumper never wants to hear,” Coddington says.

“Sometimes it's just a flower that's done blooming and has to go through its cycle again.”

The Coddingtons, who were dairy farmers before getting into the portable sanitation and septic-pumping business, grow some vegetables on their property too. Aside from gardening, they are looking forward to eventually taking their first vacation together in 36 years.

“First we were milking cows, then we had the septic business so we could never get away together,” she says. “We are going to take two weeks and go to Missouri to see our oldest daughter, her husband and baby and then out to Colorado Springs to see our youngest, and then to Denver to see my cousin. From there we would like to see Yellowstone, Mount Rushmore, the Corn Palace, and anything else that seems like something we would like to see. At any time we could change our direction and go someplace else.”

Seems like the Coddingtons' retirement is coming into full bloom — both in and out of the garden.

After Hours is an occasional feature that describes how business owners reconcile work life with family, leisure time, charitable pursuits, and personal interests and passions. Pumper welcomes story ideas. If you take part in something interesting outside work, or if you know someone in the pumping business who does, please send a note to editor@pumper.com. ■

ENGINE & ACCESSORY, INC.
Toll-Free: 1.800.327.5431
Tel: 305.573.2268
Fx: 305.576.4617
www.eamfg.com



Engine & Accessory is your one stop shop for all of your vacuum truck needs. Delivering the best possible customer experience.

Benefits include:

- **ISP Program - In stock tank and truck program**
- **Direct access to all major chassis manufacturers**
- **State of the art manufacturing facility complete with service shop**
- **Extensive parts inventory and complete product support**
- **Full engineering capabilities using the latest technology**
- **Knowledgeable sales staff**
- **Customizable units with a broad range of options**
- **Nationwide product delivery**
- **Complete package of financing and lease options**



Vacuum Service Units - Available in aluminum, steel or stainless - Sizes from 1500 to 5500 gallons

Spec yours today



DOT Code Units - Available in aluminum, steel or stainless - Options for hoist and full open rear door

Spec yours today



Flat-vac Units - Available in steel and aluminum - Wide range of size and lengths

Spec yours today



2007 Isuzu NQR - 1250 gallon tank (900/350) - Low workstation - Masport pump system - Wash down system.

One unit left in stock



We Supply

TUBING

in ALUMINUM,
STEEL or PVC

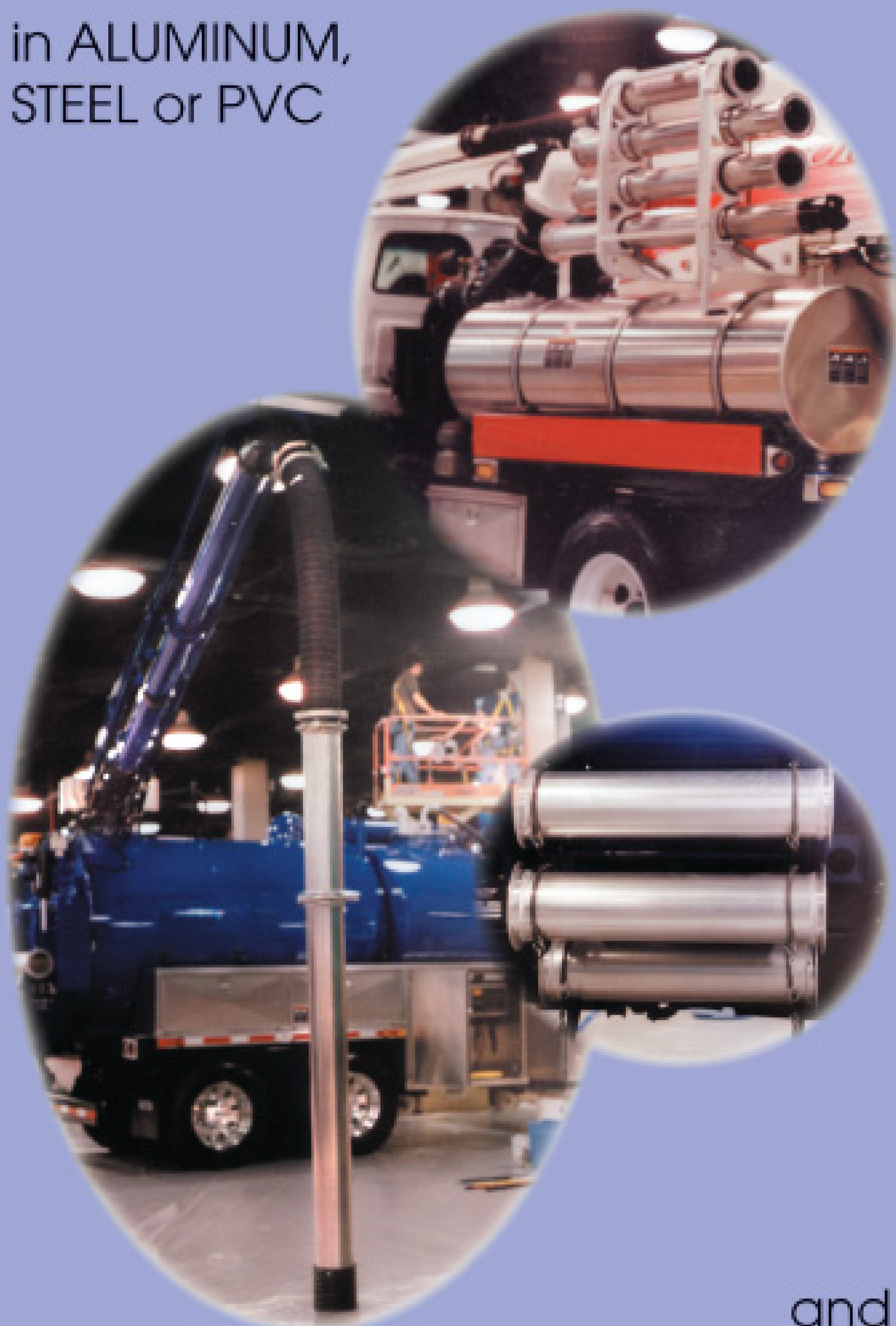

and

FITTINGS

in ALUMINUM, STEEL, GALVANIZED,
BLACK STEEL or EPOXY COATED



Kroy Manufacturing Plants

Corporate Headquarters Kroy Industries, Inc.

522 West 26th St.
P.O. Box 309
York, NE 68467
Fax: 402-362-6566
Ph: 402-362-6651 or
888-477-5769

Kroy - Olyses
626 S. County Rd. H
P.O. Box 526
Olyses, KS 67880

Kroy West
P.O. Box 1587
13400 Hanford Armona Rd.
Hanford, CA 93232

Kroy Midwest
701 S. 17th St.
P.O. Box 516
Henderson, NE 68371

Septic-Scrub™

The Demonstrated Drainfield Restoration/Maintenance Solution

Backed By Science ■ Proven with Experience ■ Many Satisfied Homeowners

Septic-Scrub™ is a superior product for the maintenance and restoration of septic system drainfields. Customers appreciate that it is environmentally safe, contains no organic chemicals and does not produce any toxic by-products. Most importantly, **Septic-Scrub works.** It breaks down sulfide buildup in the biomat and soil to allow for better water absorption.

Learn more about Septic-Scrub at www.arcan.com.



arcan

P.O. Box 65
Scotch Plains, NJ 07076-0065

For information on increasing sales and providing a valuable service to your customers, call Arcan Enterprises at **888-35ARCAN (352-7226)**



Heavy-Duty Towable Backhoe

FAST • AFFORDABLE • COMPACT • DURABLE

Gets you to the job site fast without secondary equipment!

- 18 hp engine
- Digging depth up to 8 feet
- Hydraulic drive for job site mobility
- Torsion block suspension for easy towing
- Quality machine – Built to last!

• Used Machines Available •



GO • FOR • DIGGER
www.gofordigger.com

1681 Halleck Rd. • Morgantown, WV 26505
304-296-7000 • Fax: 304-296-5034

Wee Engineer

WITH IMAGINATION

WE

Call us for a quote...

...Vacuum Trucks, Portable Toilet Trucks, Trailers
- Ready for Immediate Delivery -



2000 GMC 6500
(under CDL) 207 HP, 6-speed manual, 302,000 miles. **New 1500-gallon tank**, carbon steel, and a **New MEC 5000 Battioni 145 CFM vacuum pump**, automatic oiler. Price**\$34,500**



1993 International 4700 DT444 6-cylinder Turbo, 6-speed manual, new paint, only 189,556 miles, PS/AC. **Used 1999 1800-gallon tank**, carbon steel, and a **Moro vacuum pump**. Price**\$22,000**

Heated Collars

Preventing your valves from freezing will help your profits during the winter months. Call us for prices and sizes.



Wee Vac

The Wee Vac fits through a standard doorway and can pump up to 45 gallons of grease at a time. It has a female cam lock so it can be downloaded into your truck. It features a 110 volt vacuum pump. **Price: \$1240.00**



SPRING MOUNTS decrease fatigue on your tank frame, mounts to most tanks, Easy bolt or weld on style, Heavy-duty stress relieved springs.

Mounts with springs..\$82.00
Springs alone\$11.00 each

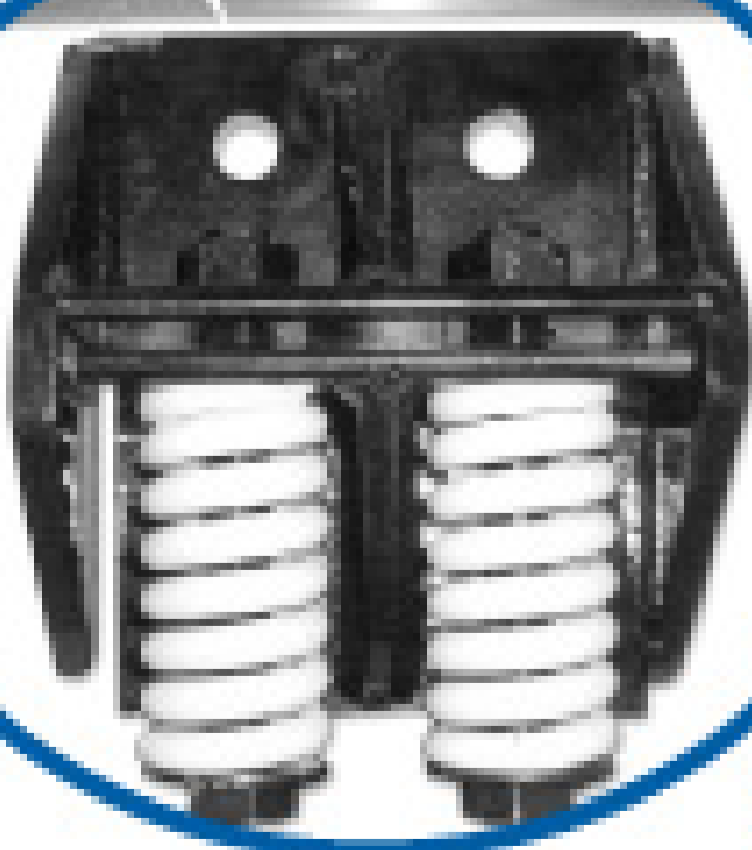

Best Heavy-Duty Portable Toilet Trailers on the Market

24ft....\$8,400
28ft....\$8,700
34ft....\$9,678

Please go to our web site and click on available units for more pics and info.



Thank you, Norman Corbin of C & C Excavation & Construction, for purchasing this 2001 International 4900 with a new 2300 gallon carbon steel tank and new MEC 8000 Battioni pump.



Thank you, Jose Gonzalez of Speedy Gonzalez for purchasing this new 3200 gallon stainless steel 3-chamber tank and new Masport pump that we installed on his Mack/Hino chassis.



Thank you, Rob and Sandy Anderson, for purchasing this 2000 Sterling with a new 3300 gallon carbon steel tank and New NVE 367 Challenger pump.



Lely Waste Solutions, LLC

Temple, TX | 800 367 5359

**70BBL OIL
FIELD UNIT**



**80BBL OIL
FIELD UNIT**



WE STOCK PACKING FOR
RIV VALVES



Temple, TX
800 367 5359
Fax 254 938 7204

www.lelywaste.com

Bruce Curry
bcurry@lelywaste.com
Earl Ballard
eballard@lelywaste.com

We've Got You Covered

**Whatever you need in
ground protection mats**

AlturMATS

Toughest mat in the industry.
Supports 60 ton vehicles.

VersaMATS

Perfect for vehicle or pedestrian traffic.



Unique waffle tread. Slightly lighter weight.

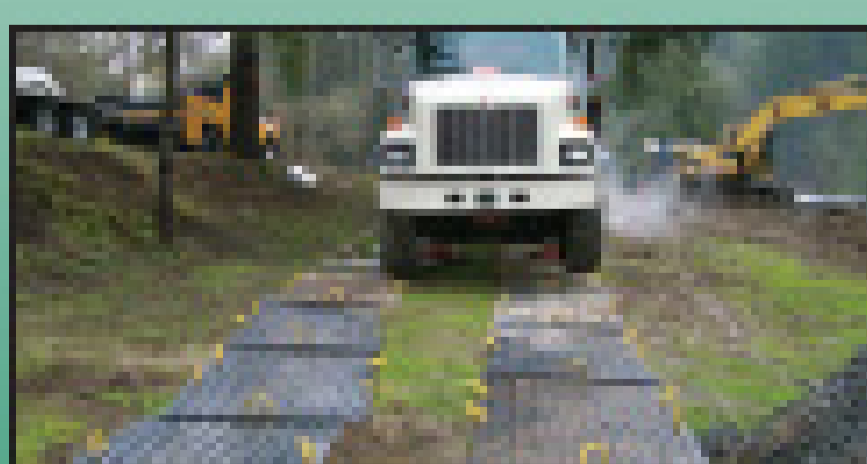

*AlturMATS continues
as the world's largest
producer of quality
ground protection mats.*



**One-Piece Plastic
Outrigger Pads**
Available in a variety of sizes.

AlturMATS®

sales@alturmats.com

www.alturmats.com

Call for the name of
your nearby dealer:
888-544-6287

Keep Drainfield Soils Working

Proven effective worldwide since 1953

*Acts to restore soil drainage by correcting chemical impact
of sodium in household products on soil structure*



KEEPS SOIL OPEN AND WORKING

*Sodium found in ordinary
household products is the primary
cause of drainfield long term
failure and replacement.*

DRAYNER SEPTIC SEEP

*Contains a common soil
amendment to correct
chemical binding of soils
resulting in flooding, die off of
biological clean up and
physical rise to flows surface
and backflow into tank.*

**For technical data
and field support call**

1-800-372-9637 Located in Pacific Time Zone **1-800-844-6080**



1-800-333-9274 East * 1-800-786-9274 Custom
 1-800-351-7283 HONDA Parts * 1-800-964-9274
 1-800-454-9274 Open Till 7:00pm West

* Apply For 30 Day Terms Account
 * Low Interest Lease Plan
 * 5 Offices To Serve You
 * Free Lifetime Tech Support

1500PSI Pulse On Demand



- 2HP Single Phase 115 Volt American Made Motor
- Draws 20 Amps - Adjustable
- 2 + 5 Year Motor & Pump Warranty
- Adjustable Pressure & Amp. Draw
- 25' Pressure Washer Hose, Gun, Wand, Chemical Injector, & Nozzles
- 100' x 3/16" Jetter Hose + Free 50' x 1/8" Jetter Hose (1/4" Available Upon Request)
- 4 Stainless Steel Jetter Nozzles
- 36' GFCI Protected Cord - 20 Amp.

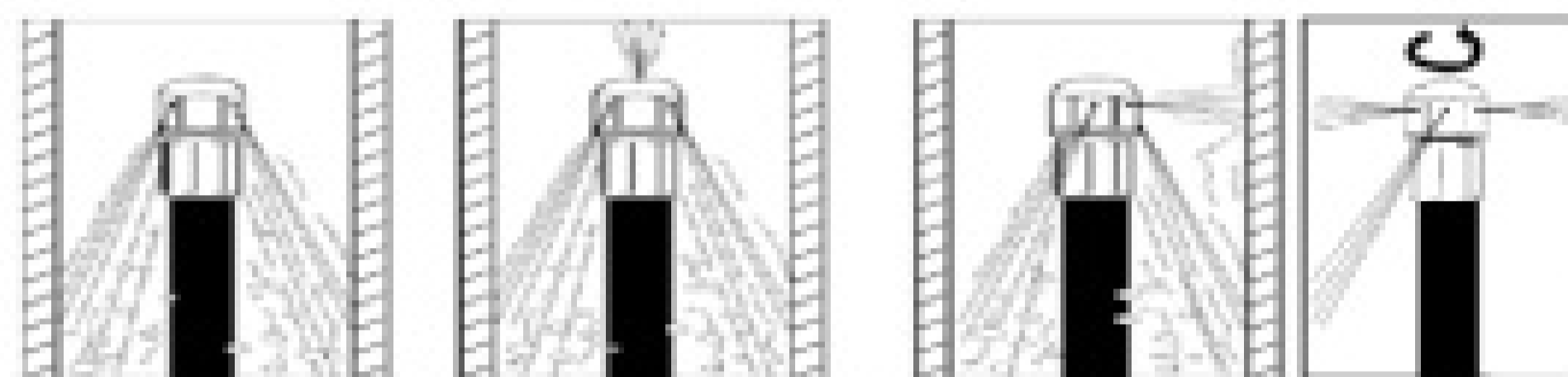

PULSE VALVE INCLUDED
 All Packages Include

MODEL EJ 2015-HC 2.2GPM @ 1500PSI
 (HAND CARRY) Weighs 62 Lbs ! **\$899**

Portable Frame Option
 Add \$69

- Light Weight Aircraft Aluminum
- Guaranteed "NO Flat Tires"
- Lifetime Warranty
- Total Weight 86Lbs
- UPS-able w/ Protective Rear Bumper

5000 & 7000PSI Available

Add A Foot Valve
 8' Jumper Hose Complete With
 Quick Connects **\$139**
 Up To 3000PSI



Portable
On Wheels

COOL DECK FRAME™

Manual Hose Reel
 Portable Hand Carry Frame
 Add \$69.99 (Up To 200')

Model	Capacity	3+	Each
27.0006	50'	\$42.99	\$49.99
27.0004	100'	\$53.99	\$59.99
27.0005	150'	\$67.99	\$79.99
27.0006	200'	\$79.99	\$89.99
386175	300'	\$107.99	\$119.99
386176	350'	\$115.99	\$129.99

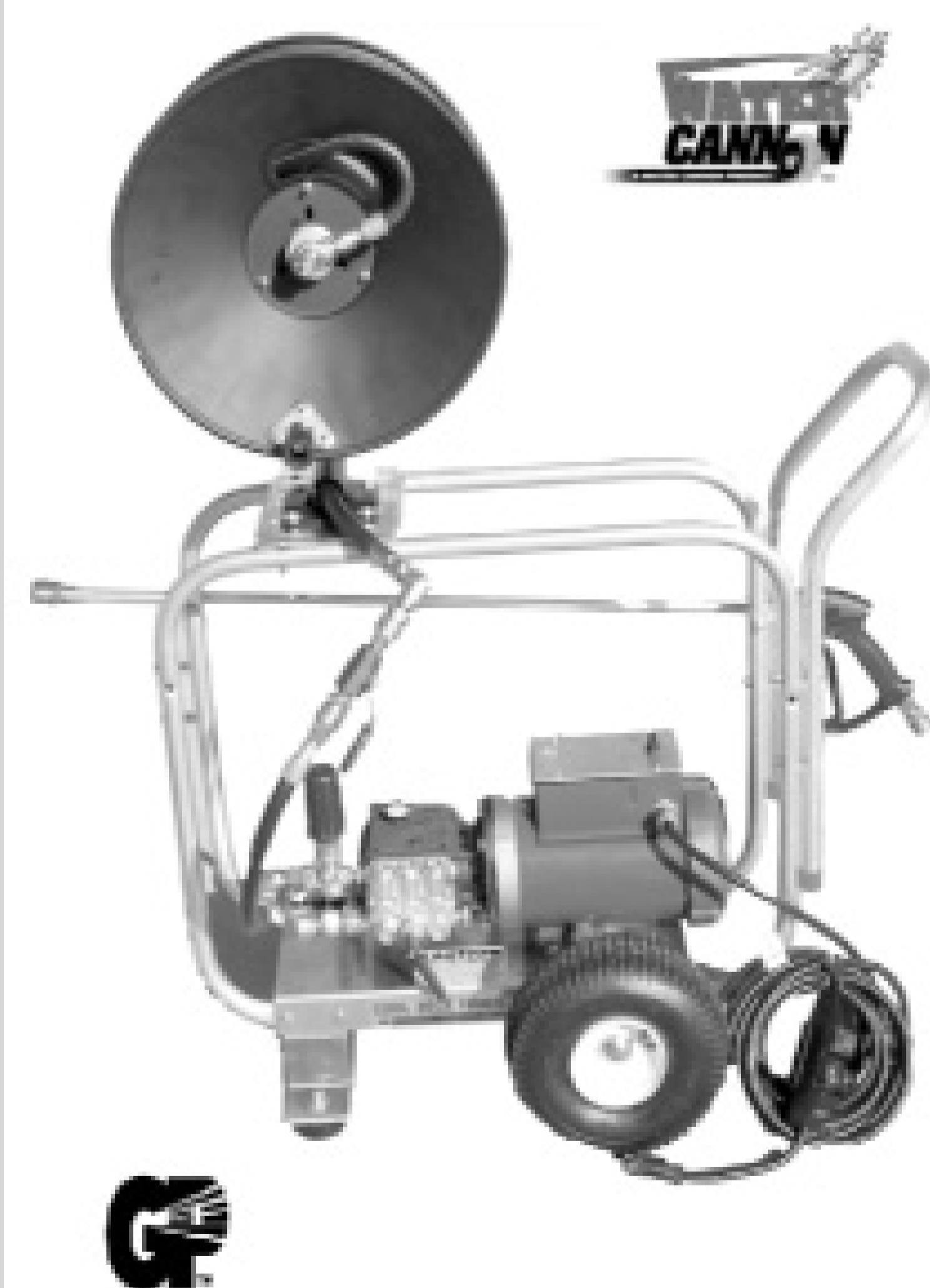

2 GPM @ 1500PSI Electric Jetter Package \$1,399

Standard Features:
 Revolutionary Aircraft Grade Aluminum Frame (No Welds),
 Lifetime Warranty, 50 Mesh Inlet Filter, EZ-Start Unloader Valve,
 Oversize Pneumatic Tires, Dual Padded Shock Absorbing Feet,
 3/4" Cold-Rolled Steel Axle, Triplex Ceramic Plunger Pump &
 Thermo-Sensor (Prevents Overheating In Bypass Mode).
 All Units Are Completely Factory Assembled and Tested in The USA and
 Delivered Ready To Operate.

- INCLUDES:
- * 150' x 3/16" Piranha Jetter Hose
 - * Hose Reel W/ 200' Capacity
 - * General Pump Jetter Version With Pulse
 - * Selective Hydro - Pulse (Pulsation on Demand)
 - * Easy Start Valve - No Load Starting
 - * Adjustable Pressure - 100 To 1500PSI
 - * Easy To Use Controls - Operation Instruction Manual
 - * Lifetime Frame Assembly Warranty
 - * Roll Cage, Hose Reel & Shut-Off Ball Valve
 - * 36' GFCI Protected Cord - 20 Amp. Plug

Industrial Electric Jetters
 Available With Auto-Stop/Start Feature

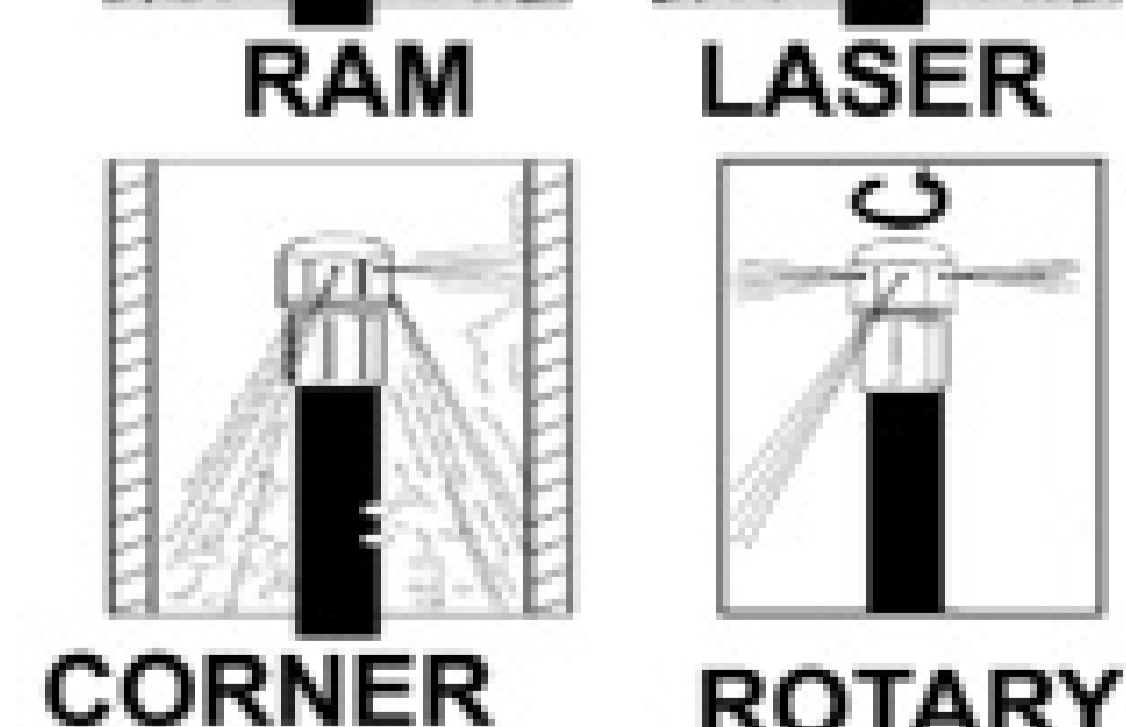
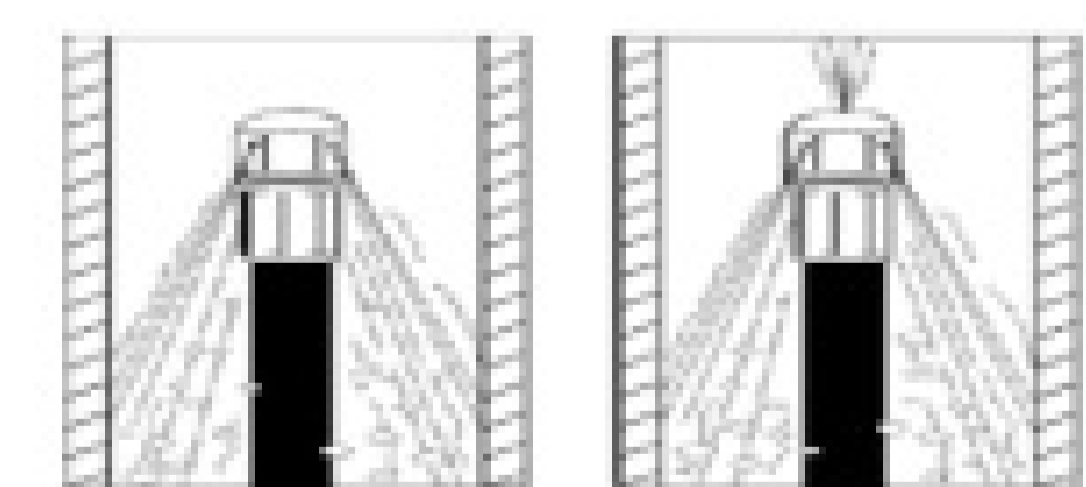
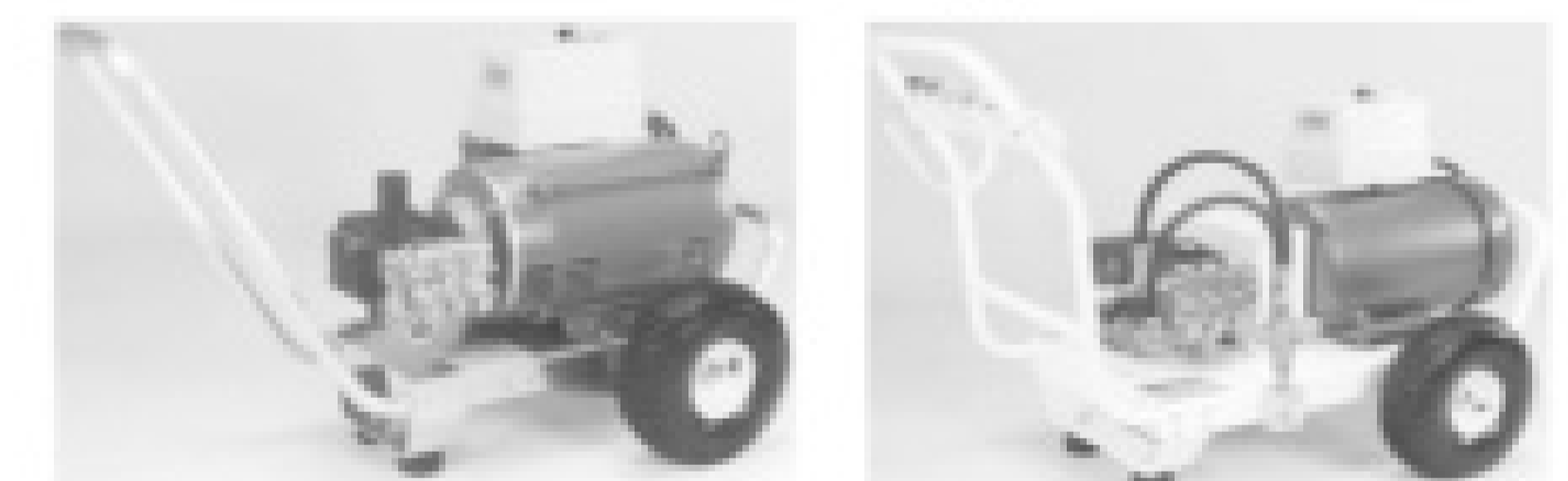

JETTER MODELS Available Up To 15GPM



Be a Miser with Expenses, a Hog with Savings

Follow this common sense approach to running your business and do a better job of weathering the next recession

By Patrick Astre

You would think there wouldn't be a need for recession planning. We should see the economic slowdowns coming. The constant wave of business cycles makes recessions as inevitable as surging booms.

The exact timing of recessions is darn near impossible to predict. Still, like hurricanes, recessions come along once in a while, and occasionally one will wreak havoc on your business.

Seasonal retailers can teach us a lesson on how to weather recessions. There's a small business around the corner from me that sells swimming pools and backyard leisure items in the summer. When seasons change their business needs, you can bet that their display changes to snow blowers, wood stoves and chain saws in September, and Christmas trees in December.

Recessions come as regularly as seasons, just not as often. Businesses should be prepared for them, so here's a guide for businesses to handle recessions and the inevitable boom that follows.

BACK TO BASICS

When you get right down to it, handling recessions, or any kind of business slowdown, consists of three things:

- Cutting expenses as much as possible without affecting sales and income.
- Maintaining sales and income as much as possible in the current environment.
- Having and properly using an emergency fund to help weather the storm.

Recognizing the basics and implementing a plan can be two different things. Here's how to start:

Understand the financial ebb and flow of your business. You should be using a computerized accounting system. Quickbooks is the premier system right now. If you have an accountant, he or she is probably using it. If you're using an old paper system and doing your own bookkeeping, your first task is to upgrade immediately. Buy the software and take a course in using it. They are available online, as well as in classroom settings.

Your primary tools are found in the company "financials," "sales" and "customers" sections of Quickbooks. You will use three primary tools:

Profit & Loss Statements, or P & L. The program will allow you to see all your expenses and income — categorized — and tell you if you've made a profit or suffered a loss during that time period. Run the P & L as far back as you can, five or 10 years if possible. Do it for each quarter and annually. You will be able to tell what period of time is most profitable, when expenses rise, what the expenses are, when income increases, and in what categories.

Sales and representatives. If you have a sales force, the sales section of Quickbooks shows sales details by individual representatives. This will tell you who's doing the best job and who needs improvement.

Customers and invoices. The customers and receivables section of Quickbooks will show you open invoices and accounts receivables details. You will know how long it takes to get paid and the number of outstanding invoices for each period. This is crucial because the time it takes to collect has a direct impact on cash flow.

Patrick Astre is a certified financial planner and founder of Astre Planning Inc. He is the author of This is Not Your Parents' Retirement and Educated Investing and the Four Seasons of Money. (Entrepreneur Media Publishing) Contact him at 631/744-9100 or visit www.ProsporousBoomer.com.



START PROTECTING YOUR BUSINESS

Once you have this information at your fingertips, you're ready to begin recession-proofing your business.

Cut expenses. A wise businessperson should be doing this all the time. Trim only the fat, and beware of cutting things that bring in revenue. The first step is to scrutinize the expenses part of your P & L statement. Take steps to reduce obvious expenses that can be lowered. Save energy costs through efficient windows or insulation, eliminate superfluous purchases, drop inventory or services that aren't profitable.

Scrutinize advertising spending. Be careful to differentiate between crucial advertising that brings in business and that which doesn't. Ask customers how they heard of you. Offer coupons that must be brought in so you know the source of the customer. Record the answers and use it to manage your advertising budget.

Make sure everyone is pulling their weight. Closely examine the performance of each employee. In a recession, you may be forced to retain only key workers. Be ready, have the decisions made ahead of time and hope the dark day of layoffs never comes.

Watch your cash flow in good times. Business is good, money pours in. Why get crazy, right? So collections are behind and expenses are too high? Profits are still good, so why bother? This relaxed attitude explains why so many businesses fail during recessions. There are many dangers of financial complacency, and when economic slowdowns occur, the business is blindsided.

Collections are abominably slow, expenses are high and it's a scramble to get rid of bad habits developed during economic booms. Pretty soon the "Going Out of Business" sign appears on the door. Straighten it all out during the good times, just when you think you don't need to — because you really, really do need to.

Set up an emergency fund. If you do nothing else, start putting 10 percent of gross revenues in a ready, liquid fund tied to your business. Use a good, steady bond fund like Vanguard Intermediate-Term Tax Free Municipal Fund, or ING Direct. Make believe this is another expense, and it is — it's an expense that might save your business some day.

Keep going until you've set aside at least six months worth of your gross income. In addition, have a ready source of credit in case a deep recession comes along and you need more cash. Be a miser with your expenses and a hog with your savings. Put it away till it hurts. It'll pull your bacon out of the fire in a recession.

IT'S COMMON SENSE

This is a basic, common sense guide to recession-proofing your business. In reality, doing this will improve every aspect of the business and boost your bottom line.

It's just like the guy who banged his head against a wall. When he was asked why he does this, he replied, "Because it feels good when I stop." It will feel good when you get this done, and you'll sail through the next recession with a smile. ■

Quality

Zoeller's reputation for quality pumps and engineered products dates back nearly 70 years. From design to testing, Zoeller products set the standard for Quality.

Innovation

Our engineering team develops and identifies new technologies and product features to produce pumps that you, and your customers, can rely on.



Service

Zoeller serves as your professional partner. You can count on us to provide professional, knowledgeable and responsive support.

Every Zoeller pump leaves our factory built with innovative features, meeting our highest quality standards and backed by our commitment to service.

ZOELLER
PUMP CO.

Extensive line. Since 1939



Quality
Service
Innovation

- Sump Effluent • Sewage Waste • Grinders • Agricultural Pumps • Hi-Temp Pumps
- Pedestal Pumps • Package Systems & Basins • Hazardous Environment Pumps
- Specialty Pumps • Home Improvement Products • Water Conditioning Products
- Backup Systems • Controls and Accessories • Onsite Septic

Call or visit
800-928-7867
www.zoeller.com

Zoeller Pump Company • 3649 Cane Run Rd. • Louisville, KY 40211 • 502-778-2731 • fax 502-774-3624



Louisville '09
YOUR PLACE. YOUR TIME.

YOUR PLACE. YOUR TIME.

▲ NETWORK WITH YOUR PEERS AND GROW YOUR BUSINESS AT THE LARGEST EVER PUMPER & CLEANER EXPO

- More than 500 exhibiting companies
- Over 12,000 industry professionals just like you
- Over 60 educational seminars
- More than 600,000 square feet of exhibit space



▲ **Networking**



▲ **Exhibits**



▲ **Technology**

FEBRUARY 25-28

Kentucky Exposition Center
LOUISVILLE, KENTUCKY | 09



EDUCATION DAY

Wednesday - February 25th

- Nearly 50 unique seminars
- Seminars all day - exhibits not open
- Additional seminars on Thursday and Friday

There is no better opportunity to improve your business than to attend Education Day at the Pumper & Cleaner Environmental Expo. Learn from professionals and network with the best our industry has to offer.



Relax and unwind
at the COLE Pub.



Education

ALL OF THIS FOR

ONLY **\$40**



PER PERSON WHEN
YOU REGISTER BY
JANUARY 23, 2009

REGISTER ONLINE AT

www.pumpershow.com

OR CALL 1-800-257-7222

Louisville '09
YOUR PLACE. YOUR TIME.

Education Day: February 25, 2009
Exhibits Open: February 26-28, 2009

4

OF THE WAYS

Restrooms That Last 10 YEAR WARRANTY



Deodorizers That Work EARN FREE RESTROOMS



SAFE T FRESH
Deodorizers

Protection That Pays™

WE SAVE YOU MONEY

Dependable Trucks CONFIGURED TO YOUR NEEDS



www.satelliteindustries.com

Support After The Sale IN PERSON AND ONLINE

It's easy to say we can save you money, but how do we prove it?

Satellite/Synergy World restrooms have a ten year warranty, which is the best in the industry. We warranty our restrooms for ten years because we know they will last and cost little to repair. Proof enough?

Safe-T-Fresh deodorizers, with our exclusive ROI Rewards Program, is your ticket to earning FREE Restrooms. Earn points with each purchase and cash them in for FREE restrooms. A free restroom lasting ten years generates over \$8,000 in revenue. Our customers consider that a pretty good savings.

Finally, we invest in our customers by having Area Managers in the field, a full staff of customer service representatives and online, 24 hour access, for ordering and all your account information. We provide this support because your time is valuable.

If you like saving money, call Satellite or your Area Manager for more information.

800-328-3332



SYNERGY WORLD



Imagine The Possibilities

Endless Billing

**The tank has been pumped. The bill has been sent.
A poster wonders what to do when a customer refuses to pay.**

This feature in Pumper reports noteworthy conversations that take place in the Pumper Online Discussion Forum for industry professionals found at www.pumper.com. The forum is split into several topic areas: General Discussion, Business, Parts & Accessories, Portable Sanitation, Pumps & Blowers, Septic System Installation, Septic System Service & Maintenance and Trucks. Simply register with a user name and password and join the discussion!

Information and advice in Overheard Online is offered in good faith by industry professionals. However, readers should consult in depth with appropriate industry sources before applying such advice to a specific business situation.

Overheard Online

THE CUSTOMER WON'T PAY. WHAT NOW?

Question:

It finally happened. I am dealing with a customer who hasn't paid his bill. I have been in business for four years and this is my first. It has been 75 days since I provided the service and the customer is a real estate agent who won't return my calls. I finally stopped in his office, but he wasn't there. His co-worker said the bank was slow to pay him on the house closing, etc. I said he still needs to let me know what is going on and asked for him to contact me. Still nothing. What should I do?

Answers:

If the property hasn't officially closed, consider putting a lien against the house. Was this an inspection, a service call, or both? In counties that require maintenance, you may be able to add it to his property taxes if service was due.



Send him a registered letter requesting payment or at least a payment plan. Give him 30 days. If you do not get a response, put a lien on his house and any other homes he has. He may have rental units since he is a real estate agent. People like that (bother me) because it increases the cost for people who actually do pay you.



In California, when the house sells through a title/escrow company, the real estate agent gets his check within a day or two. Get with them to see if the sale is closed and settled. If not, go to small claims court. Once you get the judgment, file it against his name and any property he owns. Real estate agents say the owner has not paid them, so they can't pay you. When working for real estate agents, let them know up front that if they order the work they are responsible for payment.



When I was in septic cleaning, we used to imply that we would gladly give the customer a "return" of his waste if he would rather not pay the bill. When they see your pumper truck rolling up and you getting hose out, they come running out yelling. You hand them the bill and settle the matter right there. Now, the trick is that you cannot, under any circumstances, redeposit the sewage back in the system. But they don't always know that. We've collected three of the five times we used this tactic.



The issue with collection agencies is their high cost. Once you have gone this route you have committed to take 40 to 50 percent less than your original invoice. Many times clients who don't pay will purposely wait for you to turn them in to collection and then bargain with you knowing that you've committed to accepting less money for the original invoice. If you turn it over for collection, let the agency collect it.

Property liens are the best way to get paid if, in fact, you have that avenue available. If this work was conducted as part of a property sale, be sure to exercise your lien rights and insist on payment at or before the closing. Many times you can get paid by the title/abstract company, which pays out the fees at the closing.



Many states allow a contractor to put a mechanic's lien against a property. If you do that, just sit back and wait. If you routinely charge a 1.5 percent per month late fee, the end result is that you could be paid quite well when this property changes hands again.

Find out from an attorney what you can do to deadbeats. Collection agencies, in my opinion, are a bad idea. Small claims court a worse idea, because it is far too expensive to spend the time preparing documents.

Keep in mind that your true customer is the property, not the person who hired you. Similar to a corporation, that property is an entity — it is responsible to you since you serviced it. That is your target. I hope the guy who hired you thinks twice next time.

In some states, a mechanic's lien has precedence over every other type of lien, including a mortgage. Know what you are doing and hire a lawyer.



I always find that the polite, persistent approach works well. But the important thing is to have at least one face-to-face meeting with him. Then he has to explain to you in person why he is not paying. Real estate agents have regular sales meetings at their offices, so just drop in and ask the receptionist when they are. Then wait for him and present him with the bill. You will probably shame him into making a commitment to you if he truly agrees he owes the money, especially if co-workers are present.

Try to get a check at the same time. Suggest he post-dates it if he needs to. If he conveniently doesn't have his checkbook, arrange a time and date when you can meet him to collect it. It may take two or three polite meetings — I visited a customer's home three times a week for three weeks to get paid — but you will probably get your money. It's inconvenient and time-consuming, but I always feel the principle of being paid what I'm due is worth a fair bit. It's also a lot less stressful and cheaper than using the hard-ball tactics. ■

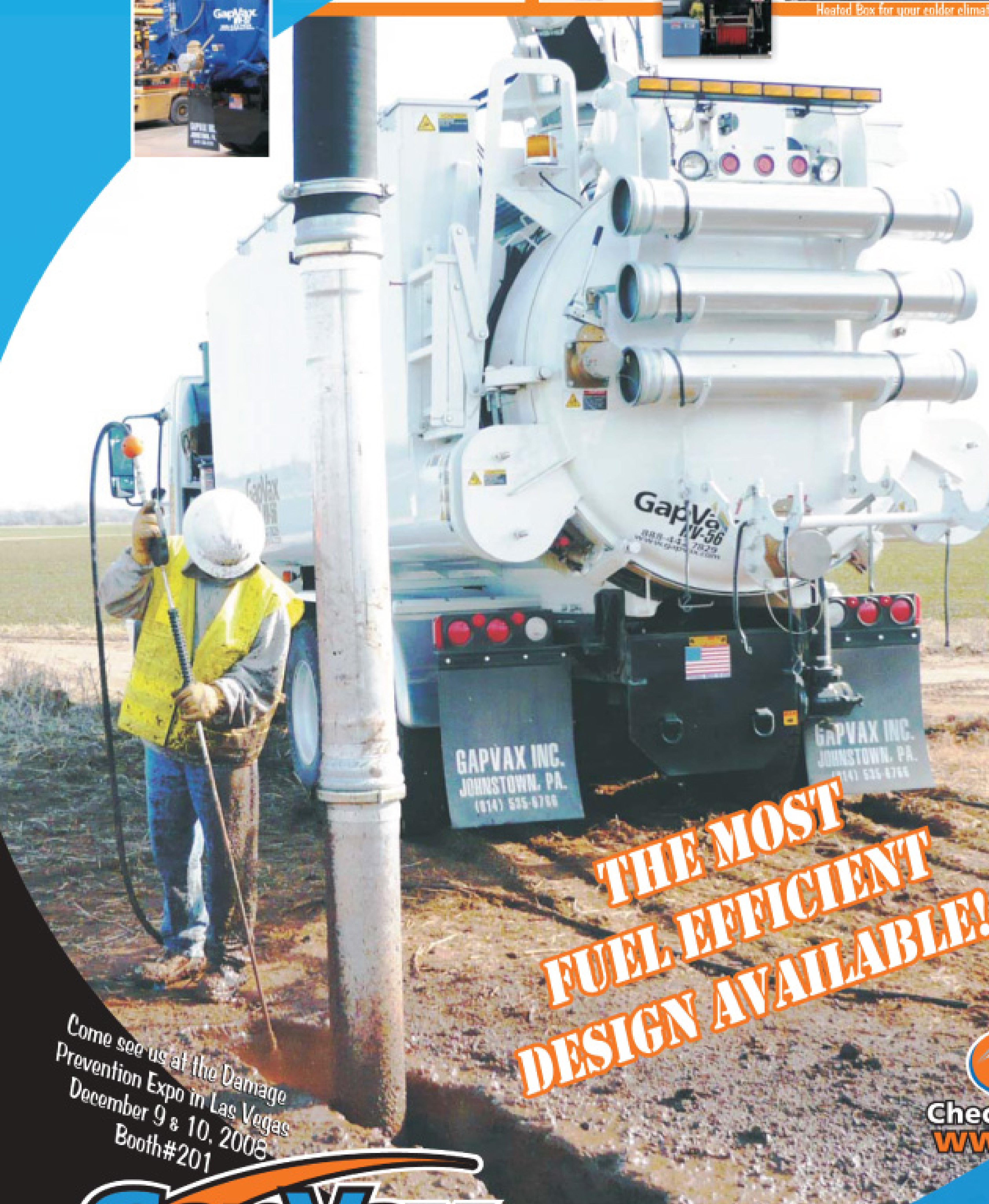

THE MOST FUEL EFFICIENT DESIGN AVAILABLE!

We keep the customer in mind with our superior quality & design. Our equipment is easy to operate, inexpensive to maintain, and fuel efficient. AND Don't forget GapVax® PartsExpress provides you with a full line of quality parts and accessories!



Check us out on the web www.gapvax.com

or give us a call
Toll-free U.S./Canada
888-442-7829

Come see us at the Damage Prevention Expo in Las Vegas
December 9 & 10, 2003
Booth#201

GapVax®
Johnstown, Pa
Superior Filtration System, Superior PD Blower,
Higher Quality Major Components and Heavy-duty Construction.



DML2000

The best Magnetic Locator on the market

- Easily pinpoint buried septic tanks, water valves, water meters, survey pins, iron pipes ...
- All weather operation; -20° to 120° F
- Works great in rain, sleet or snow.
- Waterproof Sensors; base of electronics to the crutch tip.
- Comes with a Hard Plastic carrying case or a soft-padded case.
- USA Bluebook P/N: 64978
- Best warranty in the business, a **LIFETIME WARRANTY**

Dunham & Morrow Inc.
 43676 Trade Center Pl., Suite 145
 Dulles, VA 20166 703-661-2144
www.magneticlocator.com

Steel Tanks

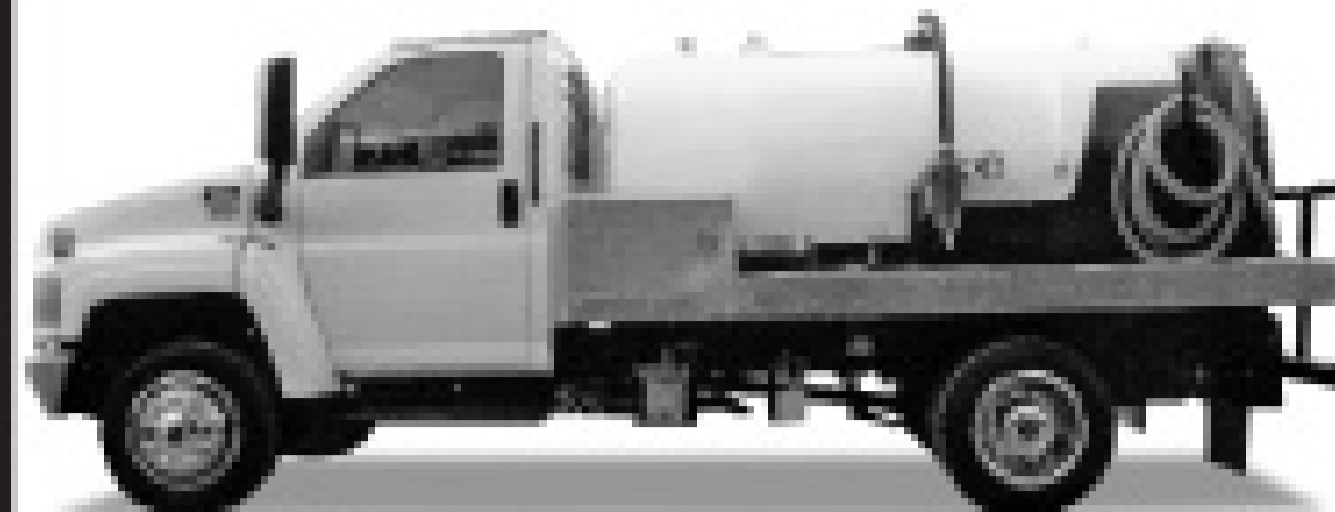

Polished Aluminum Skirting and Tool Boxes

- 2008 GMC 5500 Duramax, Diesel, Allison Automatic Transmission, 19,500 GVW, 1000 Waste, 350 Fresh **\$59,000**
- 2008 Ford, 6.4 Diesel, Automatic, 19,000 GVW, 950 Waste, 300 Fresh..... **\$57,000**
- 2008 Dodge 5500, Cummins Diesel, Allison Automatic, 1000 Waste, 300 Fresh, 19,500 GVW **\$60,500**
- 2007 Ford F750, Cummins, Automatic, Air Brakes, 2300 Gallon Tank **\$74,000**
- 2007 Chevrolet 7500, Diesel, Allison Automatic, Air Brakes, 1400 Waste, 400 Fresh..... **\$70,000**

Aluminum Tanks



by Amthor 5/16" Thick

- 2008 GMC 5500 Duramax, Diesel, Allison Automatic, 19,500 GVW, 1000 Waste, 400 Fresh **\$67,500**
- 2008 Ford, 6.4 Diesel, Automatic, 19,000 GVW, 1000 Waste, 400 Fresh **\$65,500**
- 2008 Dodge 5500, Cummins Diesel, Allison Automatic, 19,500 GVW, 1000 Waste, 400 Fresh **\$68,000**
- Any Brand Truck Available
- Used Septic and Toilet Trucks Available



Portable Restroom Trailers



Trailer Mount Slide-in Tank
 600 gallons waste, 200 gallons fresh water.
\$12,500

8 RESTROOM | 10 RESTROOM | 12 RESTROOM | 14 RESTROOM | 16 RESTROOM | 20 RESTROOM

SLIDE-IN UNITS & USED TRUCKS AVAILABLE / MASPORT, JUROP & CONDE VACUUM PUMPS



CHECK OUR PRICES
LANE'S VACUUM TANK, INC.

3133 VANZORA RD. • BENTON, KY 42025
800.592.3308 • 270.527.9945
 RODNEY LANE'S CELL **270.832.3793**

ARMSTRONG EQUIPMENT INC.

MODEL 806B SEELEVEL ANNIHILATOR™

MODEL 806B SEELEVEL ANNIHILATOR™

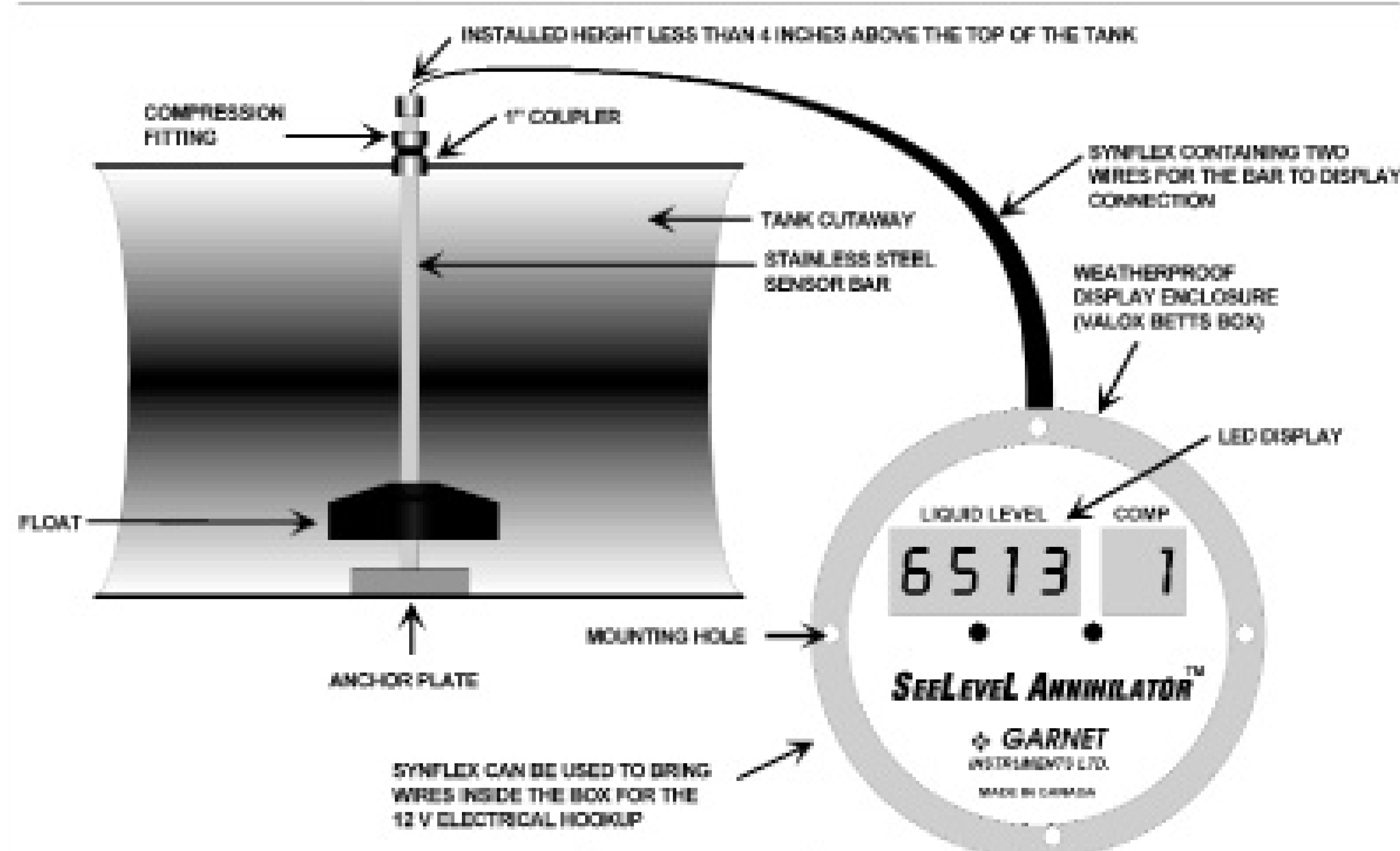

• **Accurate Readings to 1/4"**
 Even with vacuum or pressure on the tank. No need to shut down pumping to check tank level.

• **Work Safely**
 Can be programmed to control warning devices.

• **Plan Your Route**
 Tracking customers tank size allows for improved route planning.

• **Protect Your Pump, Avoid Spills**
 See the level of your tank throughout the pumping process.

• **Maximize Efficiency**
 Avoid unnecessary trips. Can I get one more load, or should I head for the dump? The guessing game is over.

• **Communicate With Your Customers**
 Pumping 1500 gallons from a 1000 gallon tank indicates problems

These are all good reasons to equip your next truck with a SeeLevel model 806B liquid level gauge system. The 806B can be programmed to read liquid levels in up to three compartments with only one display. It can also accept up to three alarm settings for triggering a warning light, sounding an audible alarm, or closing a loading valve; all while the tank is loading.



11200 Greenstone Ave. | Santa Fe Springs, CA 90670
 800.699.7557 or 562.944.0404 | fax: 562.944.3636
 e-mail: sales@vacump.com | web: www.vacump.com

To find out if the 806B can benefit your business, contact your tank manufacturer or call us
Toll Free at 1-800-699-7557



Mark your calendar!

December 8-10, 2008
Riviera Hotel
Las Vegas, Nevada



4 promotional opportunities to promote your business to onsite wastewater installers

1. **Exhibit at the tradeshow.** Connect with new buyers at the premier national educational event for installers and other onsite professionals.
2. **Sponsor Conference events**—receptions, breaks, breakfast, luncheon, Roe-D-Hoe awards & equipment.
3. **Demonstration rooms** are limited so call today to reserve yours.
4. **Advertise in the conference program**, which is distributed to all our attendees—giving you great exposure.

For a full Exhibitor/Advertiser Prospectus, please visit
www.nowra.org/exhibitor.html
Questions? Call 831-464-4884 or
email info@nowra.org.



4 great reasons to attend the Installer Academy

1. **Technical Education.** Basic to advanced training sessions present the skills and procedures for conventional and advanced treatment systems. Earn CEUs while preparing for the NEHA Installer Credential Exam.
2. **NAWT Vacuum Truck Technician Training.** If you own or operate a vacuum truck used to clean septic tanks, aerobic treatment units, holding tanks, or grease traps, this session is for you.
3. **Business Management Sessions.** Learn the latest on ways to better manage your business.
4. **The 2nd Annual NOWRA Roe-D-Hoe.** Have fun competing or just watch as competitors show off their dexterity and finesse with a backhoe.

Online registration begins August 4th at
www.nowra.org.

Save More With Lely!

Thank you
Mid East
Services



Thank you
Ryder Porto Rico

Financing Available

Steel Tanks in Stock, ready to be mounted on your truck



300 + 100 Gallon Ready to
go unit that will fit in the
back of your pick-up

The original
Gem Jet is still
the best. 2000
psi @ 15 gpm



Visit us at
the PSAI Show



Most efficient
separator on the market



Still the most inexpensive
separator on the market.

Sales Representatives
John Minnis
540-547-2463

Charlie Gilantzis
252-360-6331

Roy Coffey
828-312-9545



P.O. Box 789
Wilson, NC 27893 *-partners in wastehandling-*
E-mail: sales@lelyus.com
www.lelyus.com

252-291-7050
FAX: 252-237-7726

800-334-2763

Vacuum Pipe

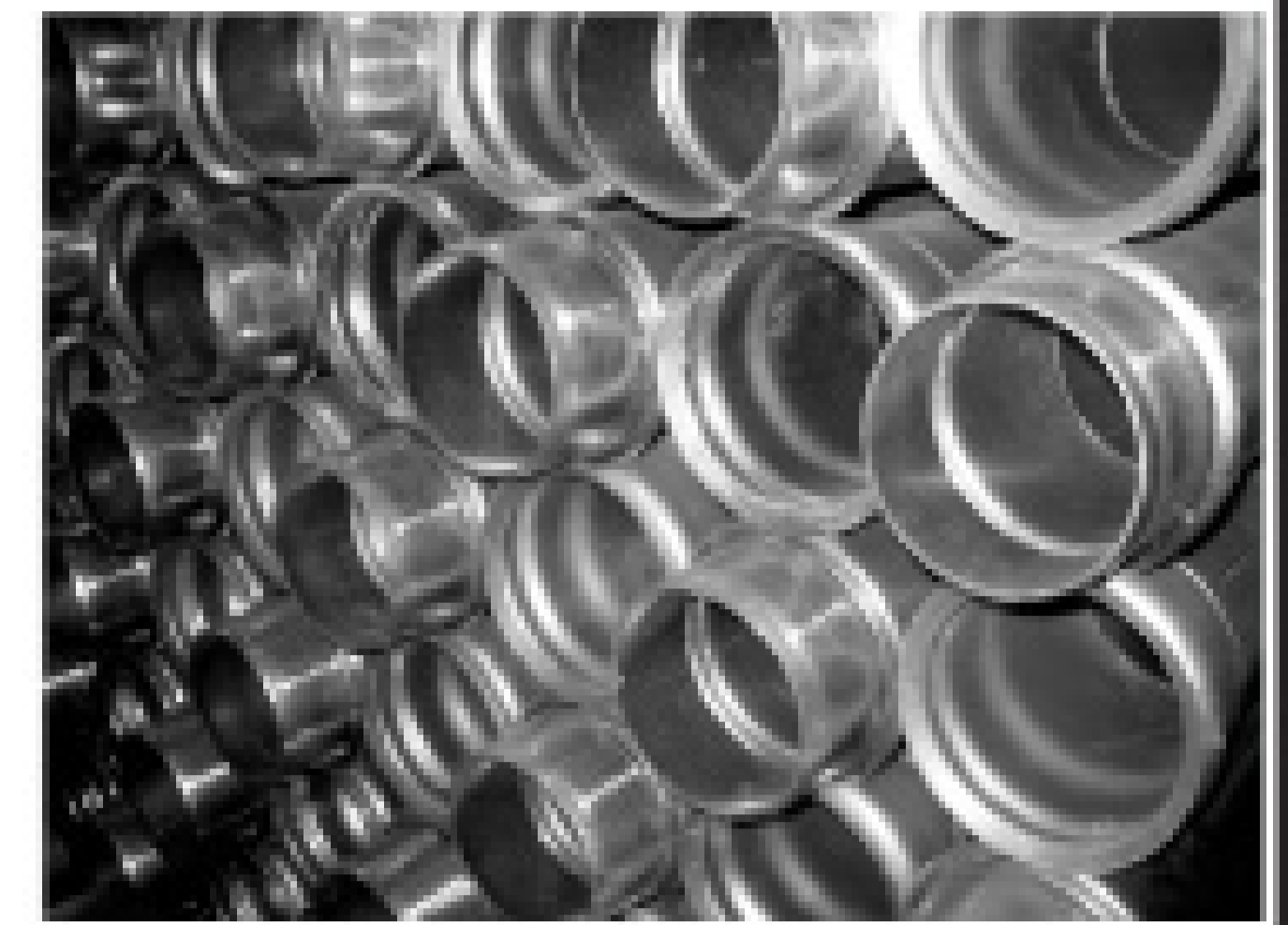

Vacuum Fittings



Aluminum Camlocks

Consolidated Pipe & Tube Co., Inc.

Fittings Flanges Hose Pipe Valves

Custom Fitting Fabrication
Ph: (806) 763-9591

Kwikk~Lokk Coupling Distributor
karl@vacpumperparts.com

www.vacpumperparts.com



ORLANDO OFFICE
800-359-7867
fax: 407-648-2096

GEORGIA OFFICE
800-851-7987
fax: 404-761-7003

Now A
Factory Authorized
Dresser Roots
Sales & Service Center



#1 Pump And Blower
Repair Specialist

Blower Repair Exchange Program: Roots, Spencer,
Robuschi, Hicks Hargraves, Holmes

CALL FOR PRICING

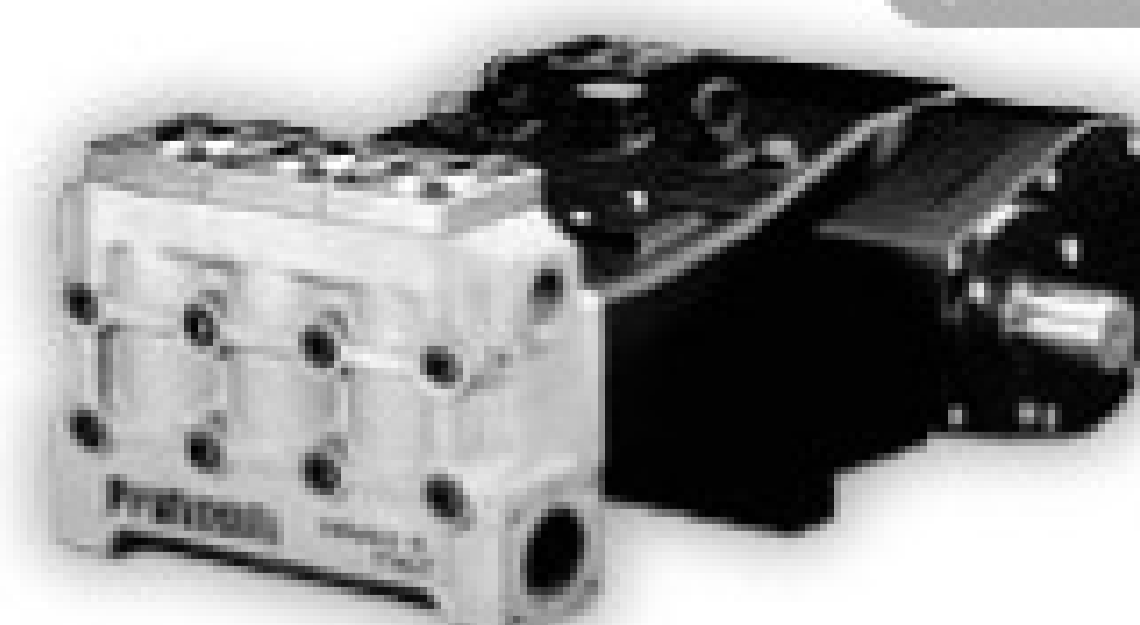

General Water Pumps
From Jet Trailers to combo units
Retrofit Kits are available!
5 year warranty

www.patspump.com

LOW, LOW PRICES!

COMPARE TO OUR COMPETITORS- IN RED

HOSE COLORS THAT MATCH YOUR TRUCK!

BLUE AND BLACK **RED AND BLACK**

HOSE

BUY BULK AND SAVE!

EPDM SUCTION BULK
100 FT ROLLS



GET IT IN COLORS
SAME LOW PRICE

2"	3"	4"	6"
\$2.19	\$3.69	\$6.59	\$11.35
\$1.69	\$2.89	\$5.25	\$10.95

EPDM SUCTION CPLD
M X F QUICK CONNECT



GET IT IN COLORS
SAME LOW PRICE
INCLUDES FITTINGS!

3" X 20'	\$84.00	\$79.95
3" X 25'	\$99.00	\$94.95
3" X 30'	\$114.00	\$109.95
3" X 33'	\$123.00	\$118.95

TIGER TAIL CPLD
M X F QUICK CONNECT



INCLUDES FITTINGS!

2" X 25'	\$96.75	\$91.70
2" X 30'	\$113.00	\$108.70
2" X 35'	\$129.75	\$125.45
2" X 40'	\$145.50	\$142.20

PUNCH LOCK TOOL



LOW PRICE

\$42.95

DUCK BILLS



LOW PRICE!

2"	\$77.95
3"	\$77.95
4"	\$89.95

VALVES

LEVER VALVES



LOW PRICE!

3"	\$112.95
4"	\$169.95
6"	\$299.95

HOSE BREAKING OFF AT THE TRUCK?
VARCO FLEXI-JOINT



\$51.99

COUPLINGS AND REDUCERS

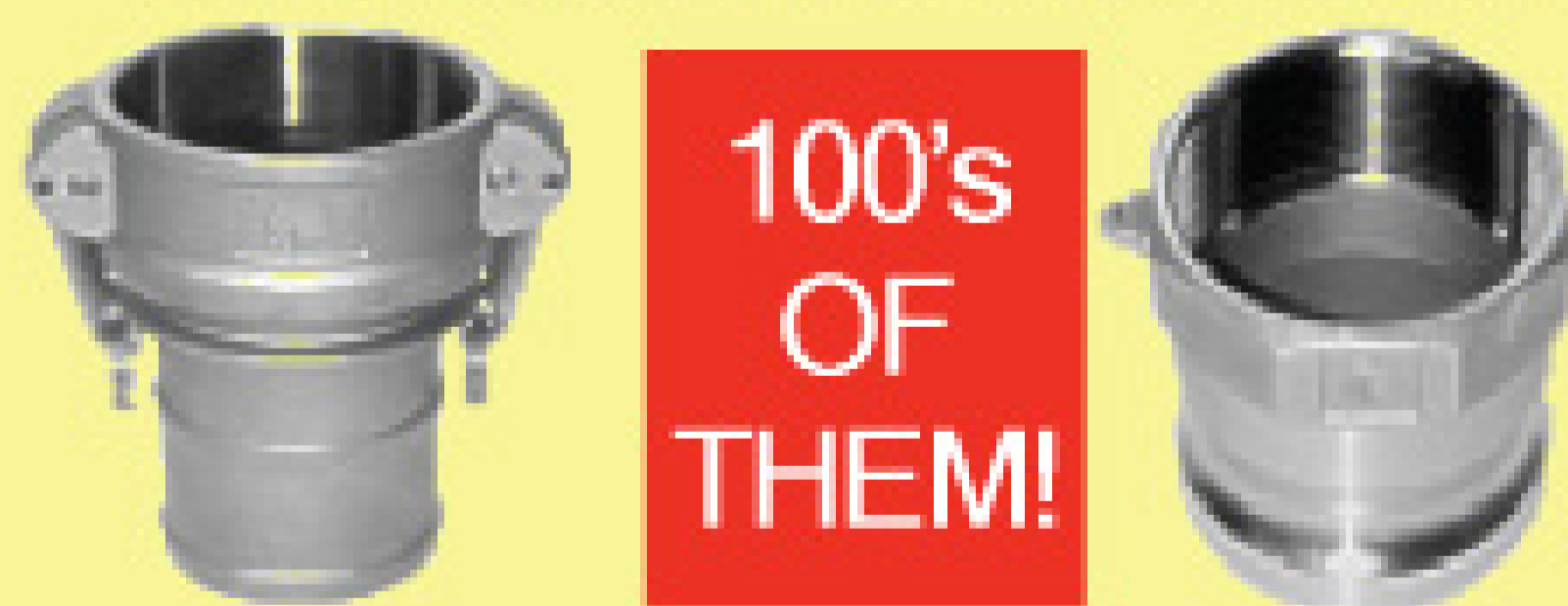

100's
OF
THEM!

MALE X FEMALE REDUCER



3" X 2"	\$17.85
4" X 3"	\$26.25
6" X 4"	\$45.95

JUROP R260



- 363 CFM
- 18" CONTINUOUS DUTY
- BALLAST PORT COOLING
- AUTOMATIC OILER

~~\$2970~~

\$2895⁹⁵

PUMPS

JUROP PN23

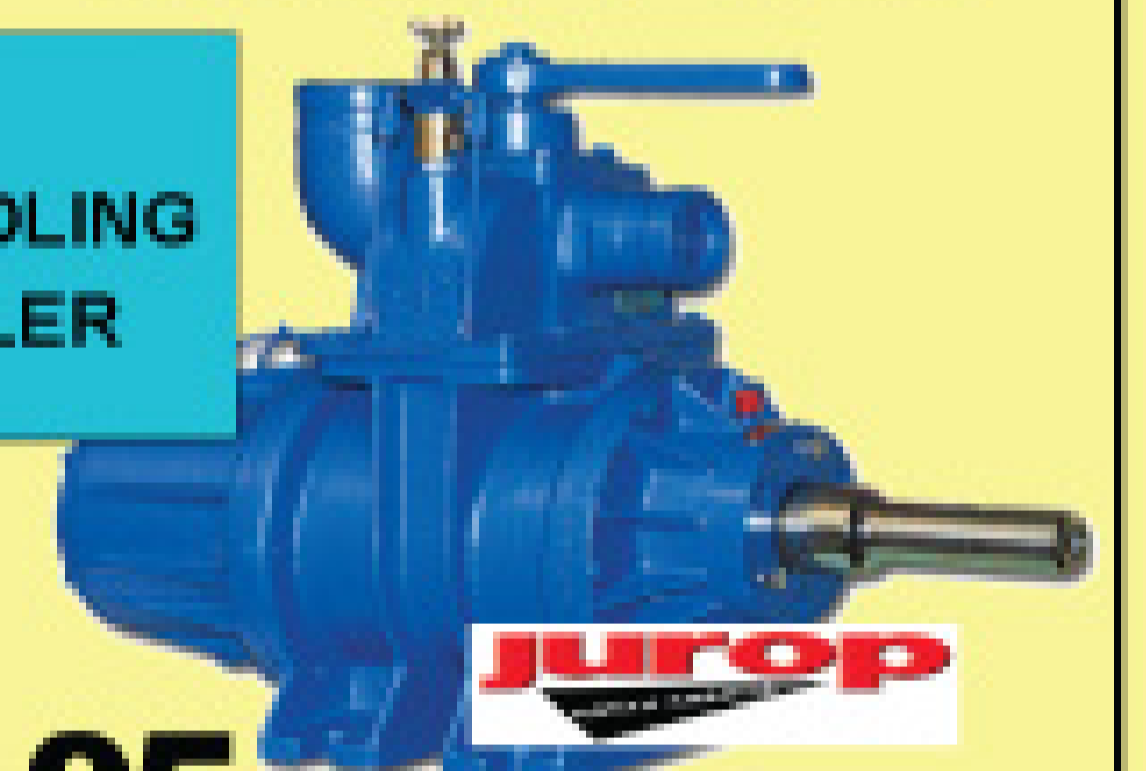

- 92 CFM
- BALLAST PORT COOLING
- AUTOMATIC OILER

LOW PRICE!

\$1165⁹⁵

VAC TRUCK ACCESSORIES

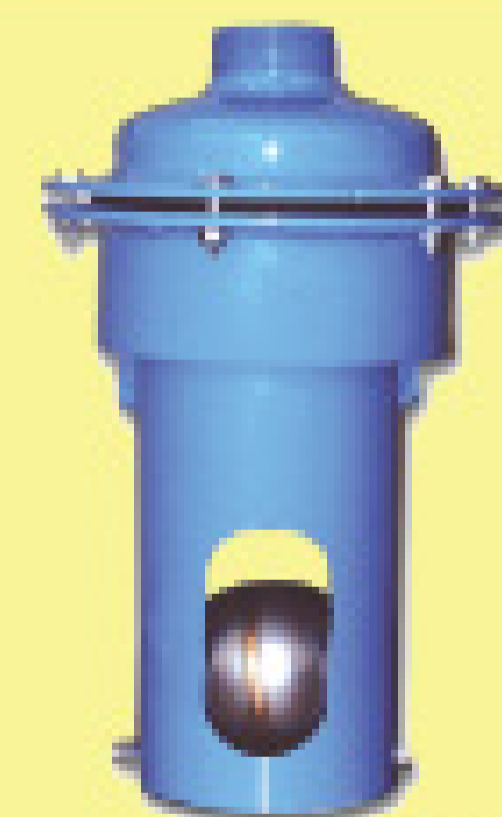

1 1/2" BRASS VACUUM RELIEF

2" **\$173.25**
3" **\$173.25**



\$28.95



BRASS PRESSURE VALVE

1 1/4"	\$29.95
1 1/2"	\$35.95
2"	\$45.95



VACUUM PRESSURE GAUGE

2.5" Face **\$12.95**
4" Face **\$39.95**

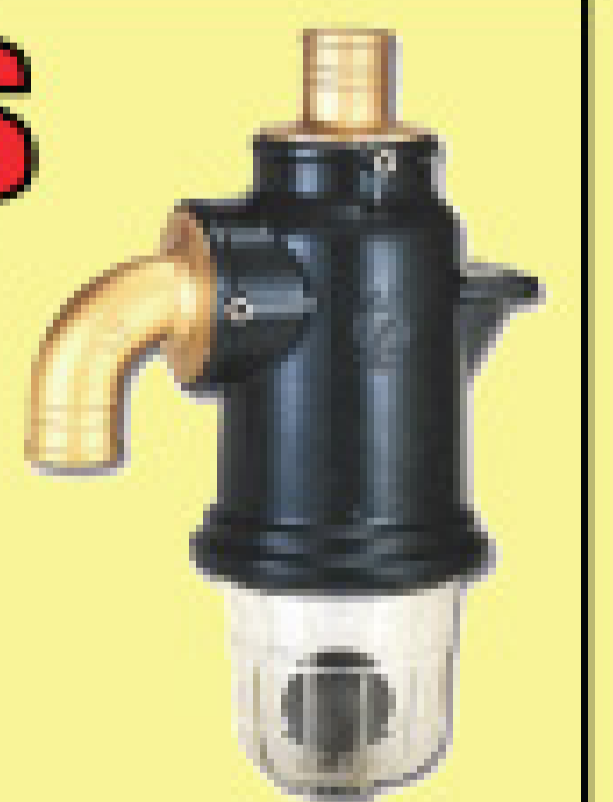

2" **\$173.95**
3" **\$235.95**

TIGER TAILS



2" X 36" **\$22**
3" X 36" **\$31**

GLOVES



12" PVC SANDY GRIP GLOVES

\$13.95 /DZ

LOW PRICE

FREE CATALOG



SHOP ONLINE AT WWW.VARCOPUMPER.COM

TOLL FREE

866-872-1224

SOURCE KEY
10P8



Mind Your Lugnuts

Picking the right truck for the job and maintaining it carefully will keep a pumper's job going smoothly

By Mary Shafer

If ever there was an industry whose personnel fit the description in Bon Jovi's song *Wanted Dead or Alive*, it's the septic pumping industry.

"I'm a cowboy, on a steel horse I ride ..." Jon Bon Jovi wails, and the collection of steel horses this industry employs is at once huge, varied and impressive.

No less impressive is the extent to which our hose wranglers depend on these vehicles, and the loyalty they seem to develop for their own particular workhorses. This month's *Pipelines* focuses on the preferences of three pumpers with definite views about the thundering herd that carries them to profitability.

Kevin Watson is concerned mainly with keeping his fleet manageable for his pumping and portables business in central Kentucky, about 30 miles



Name:
Kevin Watson, owner
Company:
Campbell's Sanitation LLC
Location:
Danville, Ky.
Employees: 5
Years in Business: 10

southwest of Lexington. He pays particular attention to performance.

"We want something under CDL size. We use the 4300 or 4400 series International, usually with 1,500-gallon to 2,000-gallon tanks. We have three Internationals and one small Isuzu service truck, which I'm quite happy with."

Watson says he's mainly an "International guy," based not on any particular bias, but because it's the vehicle make he's had consistently good experience with.

With fuel costs on everyone's mind, does Watson have a preference for gas or diesel? "We're straight diesel," he reports, based on lower overall maintenance costs and downtime, even though diesel is now the most expensive fuel on the road.

As far as preference in cab size or any other features on his big rigs, Watson isn't particular. "Just as long as it's the International brand," he says. "We've had good luck with them."

Located about 40 miles northeast of Fresno, Calif., Central State Sanitation splits its business between septic pumping, installation and repair



Name:
Frank Cotton, maintenance technician/driver
Company:
Central State Sanitation
Location:
Auberry, Calif.
Employees: 7
Years in Business: 25

and servicing portable restrooms. Frank Cotton has close knowledge of the company's vehicle fleet, an eclectic collection of makes and models.

"We have five Ford F-550s, a Kenworth T800, and a big International ten-wheeler, among other trucks," says Cotton. Speaking as the maintenance man, he adds, "I like

the newer, smaller International DT 4300s. They have lower maintenance, lower overall downtime. Of course, they're newer vehicles, but so far, they're really good."

Given the choice, Cotton prefers working with the smaller Internationals. "They have their problems, too; axles, fans, brakes, kingpins,"

Comments may be directed to Mary Shafer in care of Pumper. You may also e-mail pipelines@pumper.com.

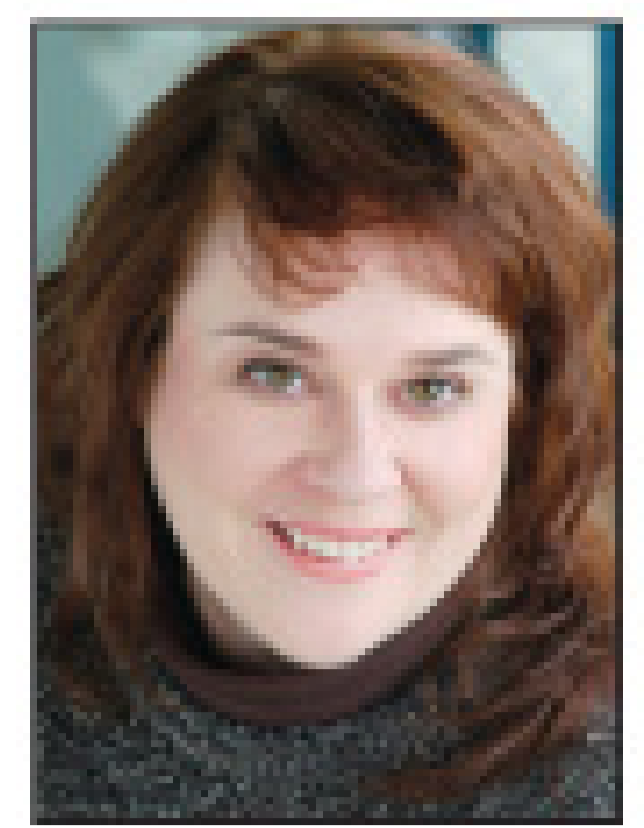

"Anything that's commercially used, that has apparatus put on it after the sale, you better keep an eye on everything. Loose things – wires, cables, small hoses – need to be tied back and kept out of the way of moving parts."

Frank Cotton

he says, but then no vehicle is trouble-free. "We've had less trouble with them because they're newer, so we'll see."

As for smaller service vehicles, Cotton works mostly on Ford F-450 and F-550 chassis. "That's the smallest we go. They just pack a lot of vacuum pumps and hoses in (the engine compartment), and there's no room to work on them."

This is an important issue for Cotton, who spends a good deal of time under the hood performing preventive checks. He recommends this proactive approach to maintenance, regardless of make or model.

"I'm big on preventative maintenance. You've got to stay on top of things. Look for problems before they become bigger problems. You really have to keep your eyes open and watch for things that are going to go wrong. When you go to check a tire, you'd better be checking brakes, looking for wire chafing, and any other wear problems. You better just go through everything, every time. If you find things going wrong and fix it right away, it's going to keep you from actually having a breakdown, and all that downtime."

Cotton believes this kind of monitoring is especially important for more complex vacuum rigs.

"Anything that's commercially used, that has apparatus put on it after the sale, you better keep an eye on everything. Loose things – wires, cables, small hoses — need to be tied back and kept out of the way of moving parts." Because the chassis and any aftermarket apparatus, such as pumps and tanks, were engineered separately, it's the job of the driver and mechanic to be sure these parts continue to play nice together.

Dickson Environmental, located in the weather-beaten country of southwest New York, asks a lot of its vehicles. The company offers excavation,



Name:
Justin Dickson, co-owner
Company:
Dickson Environmental
Location:
Bath, N.Y.
Employees: 4
Years in Business: 10

installation and repair as well as pumping to its septic customers, and their work can take Dickson drivers far afield.

Justin Dickson acknowledges long hours spent behind the wheel, and is mindful that rough roads can put an additional burden on his drivers. To combat seat fatigue, he looks for comfort features

such as air-ride suspension and easy handling. "Air brakes help make the bigger trucks easier to control, so we like those, too," he says.

As for manufacturer, "I'm partial to Peterbilts," Dickson reports. "They're quality-built, easier to drive than some others I've operated, and overall pretty comfortable."

Dickson buys his vehicles instead of leasing, and tends to keep them for a while. "Average age on our fleet right now is seven or eight years," Dickson reports. ■



49 YEARS OF DEPENDABILITY

TUFF-JON

- One-Piece Construction
- Lightweight
- Rust-Free Hardware
- Wood and Poly Skids
- Large Variety of Colors



60 Gallon Rinse Tank



Tuff-Jon



Tuff-Jon III



90 Gallon Free-Standing Sink



Tanks in 60, 105, 225, 300 and 440 Gallon Sizes

— OPTIONAL ACCESSORIES —



7-1/2 Gallon Handwasher



Tuff-Jon with Lifting Bracket Assembly



Sky Heater



Sinks available for the Tuff-Jon III

The TSF Company Inc. | 2930 S St. Phillips Rd. | Evansville, IN 47712

Toll Free: **1-800-843-9286** | **812-985-2630** | Fax: **812-985-3671**

E-mail: **tsftuffjon@sbcglobal.net** | Web Site: **www.tuff-jon.com**



PORTABLE TOILETS / HOLDING TANKS / HAND WASH UNITS / ACCESSORIES

~ Power Tools ~

To do the best job, you need the right equipment.

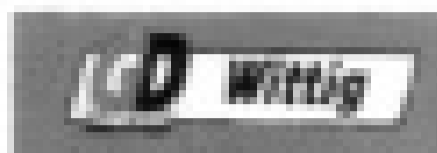

Vacuum Pumps

PresVac PV 750

Vacuum Tank Accessories



Jurop	Battione
Utile	Fruitland
Demag Wittig	Drum
Gardner Denver	PresVac
National Vacuum	Conde
Masport	Moro
Transway	Hibon
Cat Pumps & Accessories	

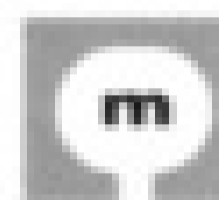
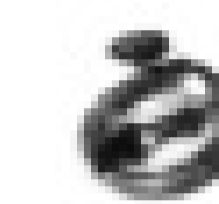
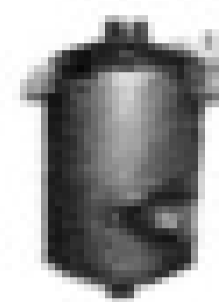
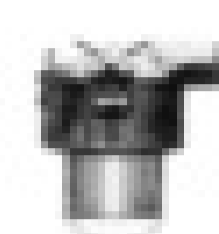

Primary Shutoff	Vacuum Gauges
Secondary Checks	Pressure Relief
Sight Glasses	Vacuum Relief
Sight Tubes	Manways
Level Indicator	Stack Muffler
Floatballs	Washdown Pumps

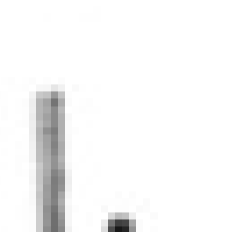
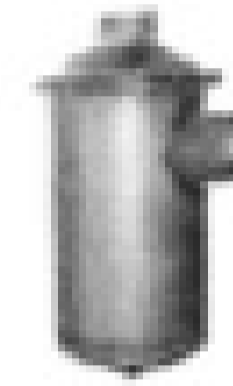
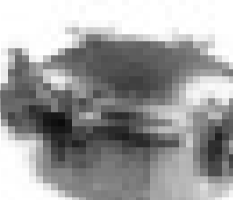

Valves

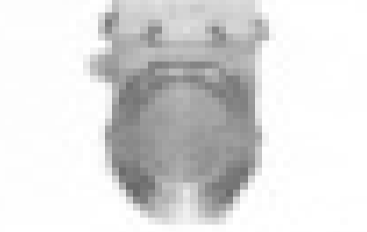

Lever Gate	Betts
Piston Gate	National Vac.
Butterfly	Ball
Check	DOT Air Vlv.

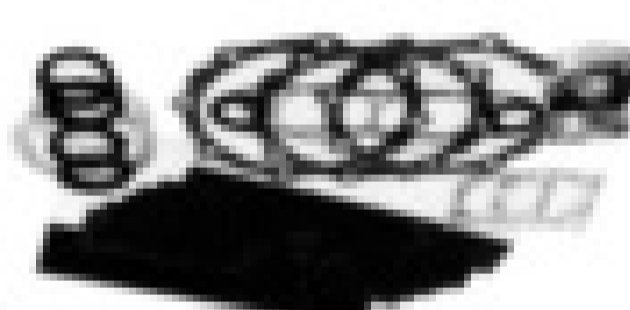

Hose & Couplings

(Rolls or Sections)	
Septic	
Portable Toilet	
Tank Truck Hose	
Abrasion Resistant (PowerVac)	
Petroleum	
PT Quick Couplings (Aluminum, Stainless Steel)	
Punchlok & Bandit Hose Clamps	

Pump Service Kits

Vanes, Bearings, Seals, Gaskets, O-rings
(available separately)

Vacuum Pump Accessories

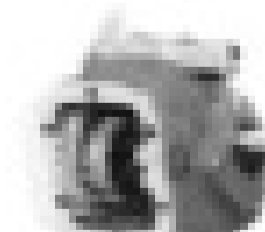
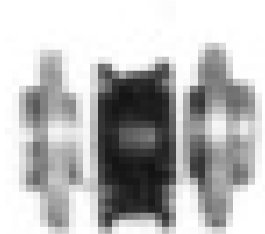
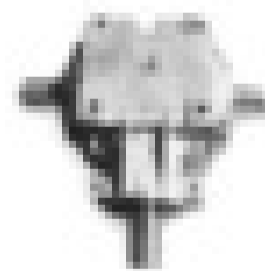

Angle Gearbox	Vacuum Pump Oil
Gearbox & Pump Cplngs	Pump & Gearbox Frame
Oil Catch	Cyclone/BagHouse Filter
Inlet Filters	(Replacement Cartridge/Bags)
Pump & Engine Pkgs	Hose Reels
Power Takeoffs	Drive Shaft & Components
(Vacuum Pump Repairs)	

Vacuum Tanks

Septic	Haz Mat DOT
Portable	PowerVac
Trailer	Rolloff / Dump
(Mild or Stainless Steel)	



1-800-243-7986 • Fax: 860-265-3786
www.comvacsystems.com

Vacuum Pumps • Components • PTO's • Hydraulics • Valves • Manways • Gear Boxes • Mufflers • Silencers • Gauges • Camlocks • Hose

Betts
Comp.
Flanges,
Gaskets
Teflon
Cork



TEAR... SQUEEZE... ODOR'S GONE!

New!

Turbo Tubes make quick work of toilet tank odor.

What could be easier? Or more powerful? The concentrated power of Turbo Tubes handles the toughest odor in seconds. Now available in three strengths for use in all seasons and conditions. New Turbo Tubes make your job easier.

- ✓ **EASY to use:** Simply tear off the top and squeeze into the tank
- ✓ **EASY to deliver:** Moisture Guard package protects against accidental activation
- ✓ **EASY to ship:** Small, lightweight packages mean less freight charges
- ✓ **EASY to control:** Proportioned quantities insure proper use and less waste
- ✓ **EASY to buy:** Turbo Tubes cost less than other portioned-controlled products
- ✓ **EASY to store:** Turbo Tubes have a long shelf life and are simple to inventory
- ✓ **EASY to handle:** No bulky containers to handle, or bottles to fill
- ✓ **SAFE to use:** Turbo Tubes are people-friendly and earth-friendly. No carcinogens.

Green Way Products are always safe - always reliable - in all seasons, all the time.

**FREE
SAMPLE
PACK**

Try them for yourself. See how Turbo Tubes make your job easier. Simply call Cindy (or your area manager) for a free sample pack.

800-241-7951



POLYPORTABLES

Listening. Learning. Delivering. Since 1972

99 Crafton Drive, Dahlonega, GA 30533 USA
Phone (800) 241-7951 or (706) 864-3776 • Fax (706) 864-8111
www.polyportables.com



TOILET DEODORIZERS • TOILET CLEANERS • AIR FRESHENERS • INSECT REPELLANT

All Green Way deodorizers, cleaners and air fresheners are earth-friendly, people-friendly products. They are developed and manufactured in our facilities in Dahlonega, Georgia by Green Way Products, a PolyPortables sister company.

Patent Pending

Introducing Safety Bumps™ for Sewer, Septic & Waste Water



Safety Bumps™ replace traditional cam and groove caps and plugs, providing a comfortable handle for the driver's hand and a "bump" that extends beyond the hose fittings and ears, protecting them from damage. Safety Bumps, patent pending, are now available in two, three and four inch, male and female models, in a glass-filled composite optimized for septic, sewer & waste water applications. Septic-only at lower prices.

Safety Lock™ eliminates spills due to cam lock ears opening up during pumping. Safety Locks™, patent pending, replace unreliable Velcro straps and hard-to-operate locking cam lock ears with an easy-to-install and easy-to-remove, heavy duty 'clip' which clicks into place over the ears.



- Save Your Drivers' Hands
 - Protect Your Fittings and Hose Trays
 - Safely Cap and Plug your Hoses
 - Eliminate Spills
- Made in U.S.A. 

Safety Pumping Systems
 (858) 530-8705
www.safetybumps.com
info@safetypump.com

Safety First... We've Got a Handle on it!



Aqua-Zyme Disposal Systems

"From the Grease Trap to the Garden"
 - Dewatering & Composting -

#1 Box on the market!

The ADS Dewatering System

is built by a pumping company for pumpers. You are welcome to come and watch the 30 yard box dewater 20,000 gallons of grease trap waste and/or septic tank waste in only 2 hours!

By using the ADS dewatering system along with our Compost Facility, we have turned our disposal costs into a profitable venture!

Call 979-245-5656 for Info!
\$ Financing Available \$

P.O. Box 489, Van Vleck, TX 77482 • www.aqua-zyme.com
 1-979-245-5656 • zymme@aqua-zyme.com • U.S. Patent # 6,364,122

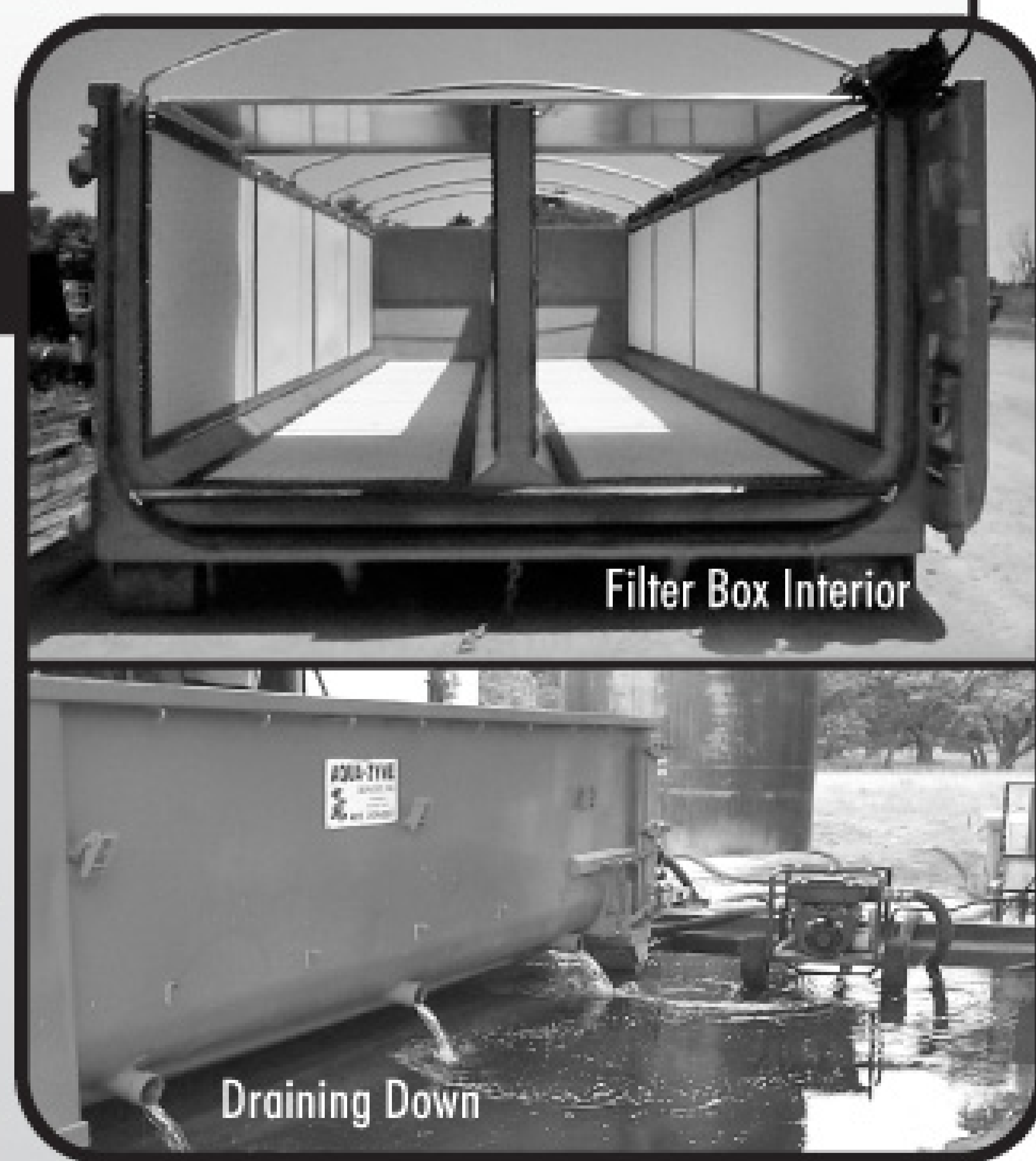

ALUMINUM, STEEL and
STAINLESS TANKS manufactured,
assembled and serviced by quality
Imperial employees!



IMPERIAL
INDUSTRIES INC.
800-558-2945

WE DIDN'T JUST INHERIT THE NAME "IMPERIAL",
WE EARNED IT WITH "IMPERIAL" QUALITY/DESIGN/SERVICE



I.H. 4000 Gallon
Aluminum Tank.
Call for Details!



2500 Gallon
Aluminum Tank.
Call for Details!

CUSTOM MANUFACTURED TANKS IN STEEL, ALUMINUM AND STAINLESS

- STOCK UNITS:
- 2009 I.H./4000 Gallon Aluminum Tank
 - 2008 I.H. / 2500 Gallon Aluminum Tank
 - Ready For Delivery (Call For Details)

- STOCK TANKS:
- 2500 Gallon Steel & Aluminum
 - 3600 Gallon Steel & Aluminum
 - 4000 Gallon Aluminum
 - All Ready To Mount On The Chassis Of Your Selection

Call Jim Stieber or Brad Rybarczyk for details!

WE HAVE UNITS AND TANKS IN-STOCK TO MEET ALL YOUR PERSONAL NEEDS!

- 2008 F550/875 Gallon Steel Service Unit
- 2008 F550/1100 Gallon Aluminum Unit
- 2008 Fuso/1100 Gallon Aluminum Unit



In Stock &
Ready to Ship with
in 24 Hours

- Slide-In Units in Steel/Aluminum
and Stainless in various capacities!



V&H AUTOMOTIVE
Marshfield, WI 54449
Randy Tischendorf

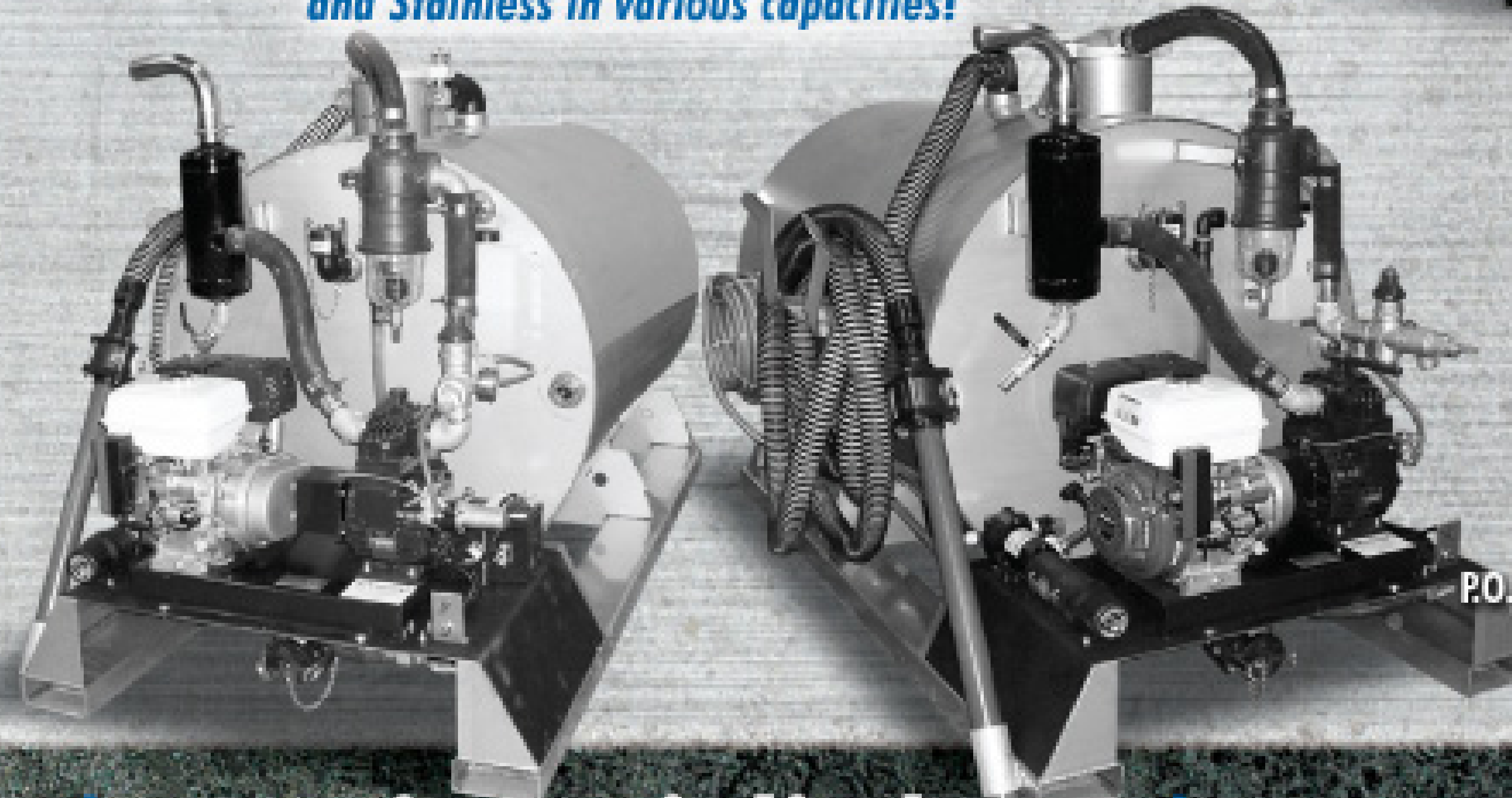

IMPERIAL
P.O. Box 1685 • Wausau, WI 54402
Tom Aerts

800-722-7382, ext. 244 | www.imperialind.com | 800-558-2945, ext. 317

Dewatering Containers



ROR-40-22 (40 yd) Sludge Container w/ Ratcheted Sealed Gate

Bakers Waste Equipment Inc (BWE) designs and manufactures specialty containers which are specified to assist septic and grease haulers in their wet waste handling applications.

Filter Panel Structures are available in stainless steel, galvanized, or mild steel with chemical resistant protective coatings on the substructure.



Standard Specifications Include:

Capacities in 15, 20, 30, and 40 cubic yard designs
Heavy Duty Construction
Processing Rates from 15,000 to 25,000 Gallons Per Day
Internal Center Wall Provides Dual Compartments for More Efficient Filtration and Separation of Waste.

Designs Available with Permanent (330 Micron) or Disposable Filter Media
(3) Ratchet Closures on Sealed Sludge Gate
Cable Lift or Hook Lift Capabilities



BAKERS WASTE EQUIPMENT

800/221-4153

828/879-8222

828/879-8557 fax

www.bwe-nc.com

1000 Gallon Trailer Mounted Vacuum System



EXPERTS IN PORTABLE VACUUM SYSTEMS!

PACS 1000

PACS trailer mounted vacuum systems are available in a variety of configurations. PACS 1000 is designed for removing liquids, solids, and sludge from land or water. Costing less than vacuum trucks, the PACS is approved for highway towing. Integral hydraulics allow the PACS to run oil skimmers and pumps, as well as lift the tank to dump contents.



ELASTEC MiniVac

Oil Skimmer Sucking up money for vacuum trucks

Our Drum Skimmers are optimal for rapid response oil cleanup. Extremely efficient and cost effective, they will give you an edge over competitors.



DrumIt

The drum filling vacuum head with auto shut off. DrumIt quickly connects to vacuum trucks for a clean interception of debris and liquids.



ELASTEC
AmericanMarine
Innovative Environmental Products

1309 West Main, Carmi IL 62821 USA
Tel: (618) 382-2525
Fax: (618) 382-3610
E-mail: elastec@elastec.com



www.elastecsales.com

PU06/08

Supplying your Business for Seasons of Success



- **One-Stop Shopping**
Our wide selection of products makes shopping at several different places for all of your needs a thing of the past.
- **Very Competitive Pricing**
- **Huge Selection**
We carry a wide selection of portable restroom parts and accessories to take care of all your needs. Including toilet parts, pumps, pressure washers, hoses, valves, fittings, tank components, chemicals, dispenser systems, hand sanitizer, deodorizers and odor control products, engines, sink parts, cleaning supplies, and much much more.
- **Two Locations for Faster, More Economical Shipping**
Our warehouses in Utah and Georgia are strategically placed to service every state.
- **Custom Pump Trucks**
If you can imagine it, we can build it. We pride ourselves on our ability to work with our customers and design an efficient and effective pump truck designed around your custom applications.



**CALL TODAY for your
FREE product catalog!**



"YOUR ONE STOP SOURCE"

1-888-935-1133

www.toico.com

YOUR ONE STOP SOURCE FOR PORTABLE RESTROOM PARTS AND SUPPLIES

Proper Venting Eliminates Odors

When customers complain about a whiff of rotten eggs caused by the septic system, a quick fix usually takes care of the problem

By Roger E. Machmeier, Ph.D.

Q I have occasionally had problems with homeowners complaining about getting odors now and then caused by their septic system. I have read replacing the outlet tee of the septic tank with an elbow can eliminate the odor. What do you think of this idea?

A Odors from a septic system do present a problem now and then. There is usually a fairly simple solution. However, the solution is not to change the vented tees of the septic tank.

The bacteria active in a septic tank are anaerobic. Anaerobic means the bacteria operate without oxygen from the air. The result of their anaerobic activity generates odors, the most common of which is hydrogen sulfide gas. The odor from hydrogen sulfide is like the odor of rotten eggs. Not too pleasant!

There is not a great deal of gas generated in a septic tank, but the gas must be released so pressure does not build up in the tank. If the septic tank has inlet and outlet baffles, they must be vented. If the inlet and outlet are tees, they must have upward extensions and be vented.

GAS PRESSURES

I have heard of the inlet tee being replaced by an elbow. If this is done, then the gases from the anaerobic bacteria would need to move out into the drainfield in a gravity flow system. I don't see much of a problem with this, unless the inlet elbow becomes plugged for some rea-

son. It would seem an inlet elbow could not be cleaned out as easily as an inlet tee.

If the septic tank discharges into a pumping tank, then there can be some gas pressures building up in both the septic tank and pumping tank. Whether this will cause a problem depends on how tight the tanks are.

I have also heard of the outlet tee being replaced by an elbow, and this supposedly cures the odor problem. The gases are still being generated, and as the pressure builds up in the septic tank, the gases will move out through the inlet and into the plumbing vent system. The plumbing vent outlet is on the roof of the dwelling.

Why isn't there still an odor? I suspect the reason is the soil absorption system is vented and air circulates through the septic tank and out the vent pipe on the roof, carrying the odor with it. Replacing the outlet tee with an elbow prevents this air circulation. If there were no air movement through the septic tank, there likely would be very little gas movement from the tank and no detectable odor.

Vent pipes are of no value in a soil absorption system. If all the installed vent pipes were capped or eliminated, this would have the same effect of restricting the air movement as replacing the outlet tee with an elbow.

DOWNDRAFTS THE CULPRIT

The theory for the installation of vents in a soil absorption system is to keep the system aer-

obic. However, the theory is wrong since the oxygen must be introduced on the soil side of the biomat. That is where the oxygen is needed. There is no way sufficient oxygen can be introduced into a trench by a surface vent to keep the septic tank effluent aerobic.

So, I definitely suggest the septic tank continue to have vented baffles or vented tees. If air circulation from the soil absorption system is prevented, then there will be only a small amount of gas flowing out of the vent pipe on the roof.

The vent pipe of the plumbing system must extend well above the roof line according to most plumbing codes. As I recall, some plumbing codes state the top of the vent pipe shall be one or two feet higher than a level line 10 feet long from the vent pipe location to the roof. The sketch shown here may help explain why the vent pipe should extend well above the roof line.

If the top of the vent pipe is not far enough above the roof line, wind currents may carry the odors along and down toward the ground.

Down drafts along the side of the roof where the vent is located may be caused by wind blowing over the roof from the opposite side. Wind blowing over nearby trees, which are higher than the house, can also cause downdrafts. The downdrafts may occur only when the wind

is from a certain direction and at a certain speed. This is why the odors may happen only every now and then.

QUICK FIXES

What are the solutions to the odor problem? One simple solution may be to lengthen the plumbing vent and extend it well above the roof line.

In some cases some pruning of nearby trees may be in order. This is a fairly drastic solution, however.

I think there may be a better and easier solution. Many have successfully used an activated charcoal filter, which fits on the top of the existing plumbing vent. The charcoal filter does not restrict the flow of air or gases, but takes the odor out of the escaping sewer gases.

I suggested this type of filter to one of my clients, and it was very successful in eliminating the outside septic odors. There

Readers are welcome to submit questions to the Answer Man. Send your question to COLE Publishing by e-mail to editor@pumper.com, by fax to 715/546-3786; or by mail to P.O. Box 220, Three Lakes, WI 54562. We will pass your question along to Dr. Machmeier.

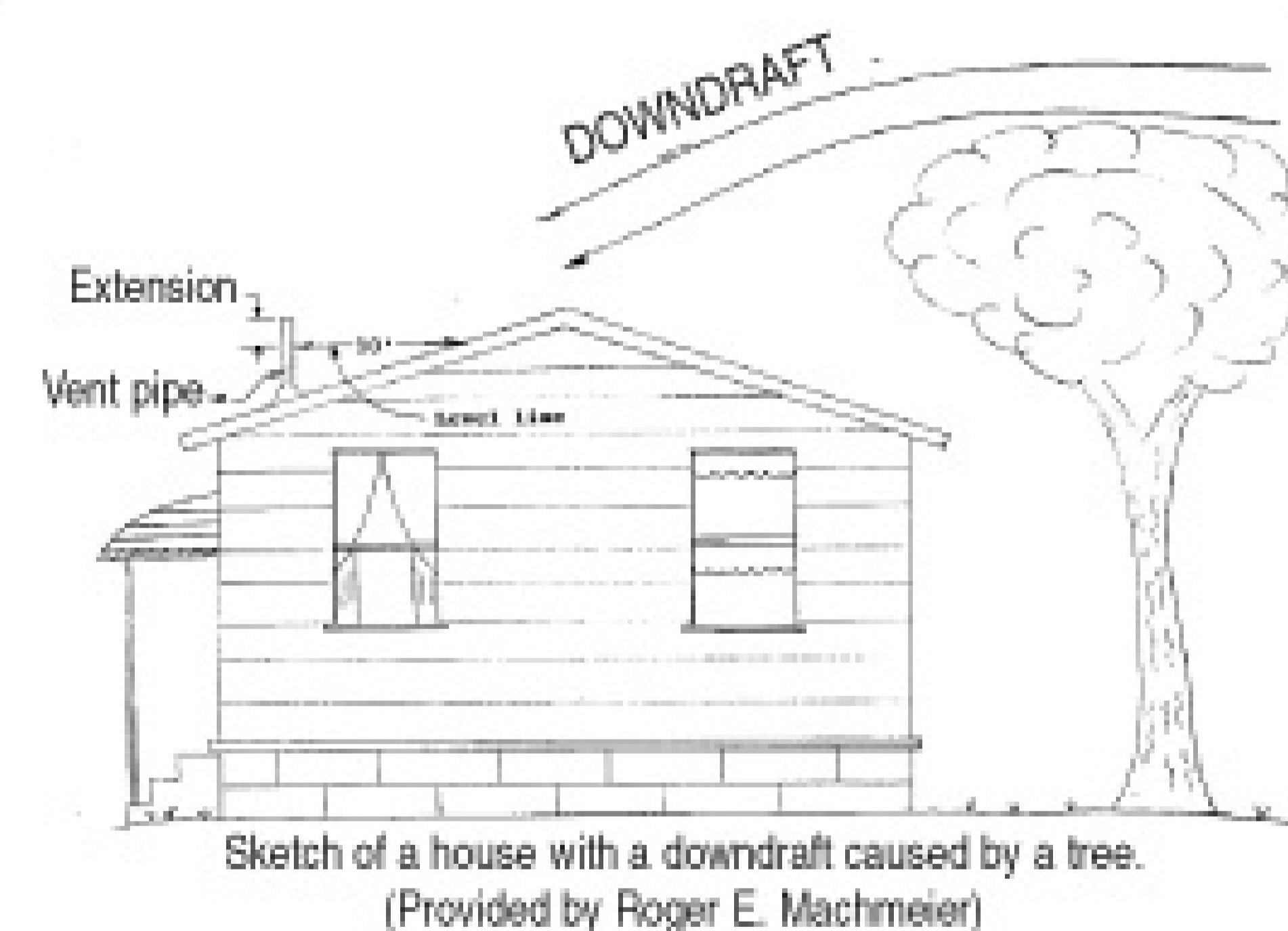

are usually a few suppliers of charcoal filters for plumbing vents advertised in *Pumper*.

In conclusion, don't replace either of the septic tank vented tees with an elbow. Look elsewhere for the solution to the odor problem. ■

TOP LINE

NEW Top Line Accessories

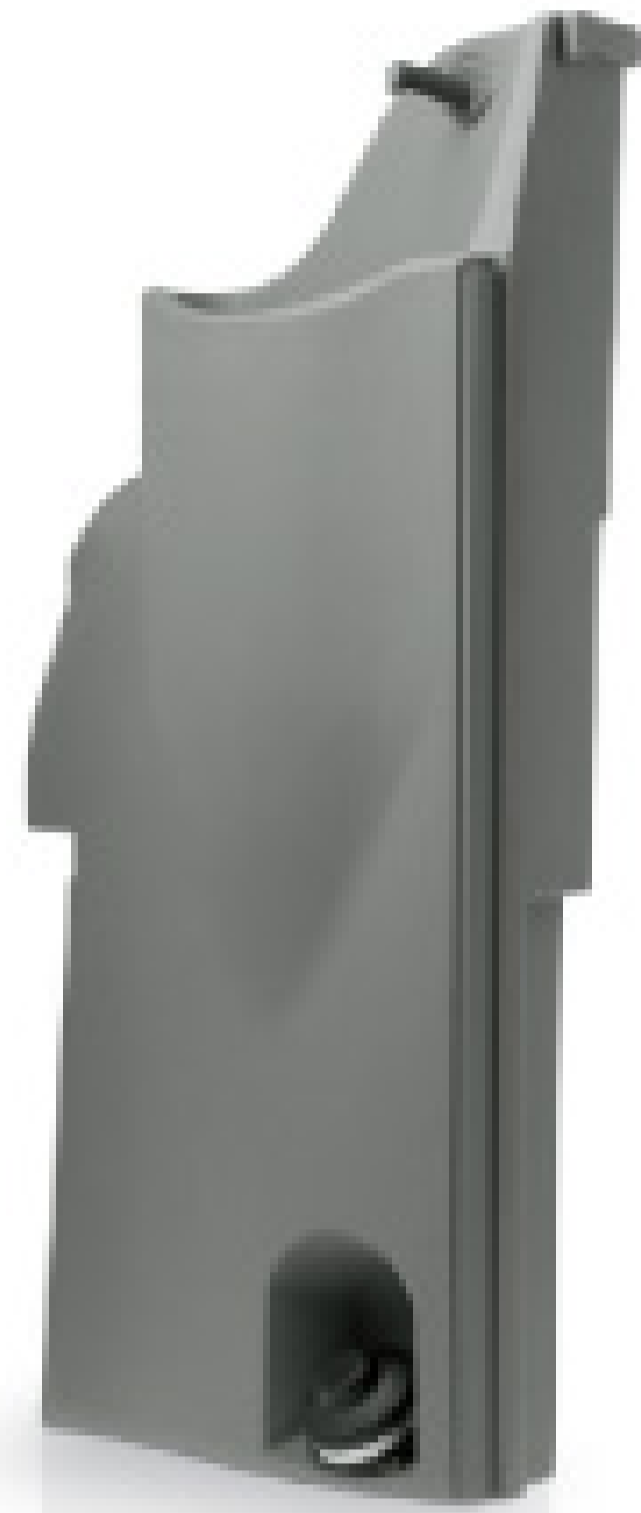

Hand Wash



Fresh Water Flush



LEONES

Walls do not have Armal logo.

# of toilets	8	104
DISCOUNT PRICE	\$419.00	\$319.00
FREE DELIVERY		
<small>Continental US only.</small>		

Armal

www.armal.biz

Armal Inc. 122 Hudson Industrial Drive, Griffin, GA 30224 - USA
 Phone 770 491 6410 - Fax 770 491 9458 - Toll Free 866 873 7796
armal-inc@armal.biz

We pay attention to the details.

- Fabricated to the best industry standards using the highest quality products available
- Custom configurations to your specifications
- VISA, American Express, MasterCard, & Discover
- Fast, same day shipping, low freight rates



**ATLANTA
RUBBER &
HYDRAULICS**

1640 D Sands Place
Marietta, GA 30067
Toll Free: 800.282.6272
Phone: 770.955.5225
Fax: 770.955.2377
e-mail: dragsdale@atlantarubber.com

MEGA Holding Tank

1250 Gallon Size



Options

Black Color • Level Alarm • Custom Fittings

LOW PROFILE Portable Holding Tank

100 • 210 • 300
Gallon Sizes

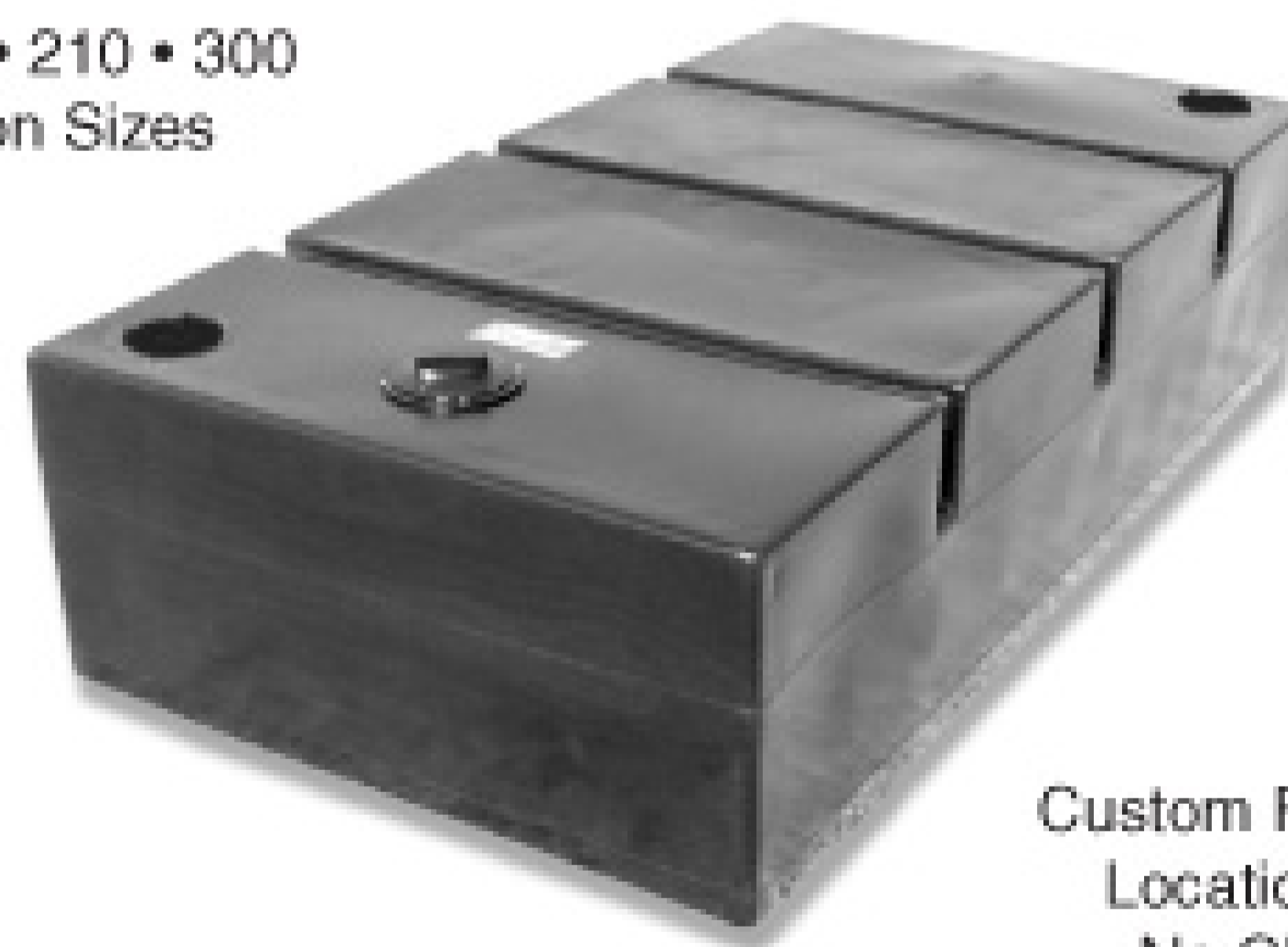

Custom Fitting
Locations at
No Charge

On-Site Water System

OSW PLUS —

- Tough 65 gal. Tank
- Removable cover for easy cleaning
- 115V On-Demand Pump 3.5 gpm 45 psi
- Low water shut-off
- GFCI Protected
- Filter
- Ships UPS



Easy View
Natural

Office
Grey

OSW DELUXE —

- Add external fill connection w/float valve

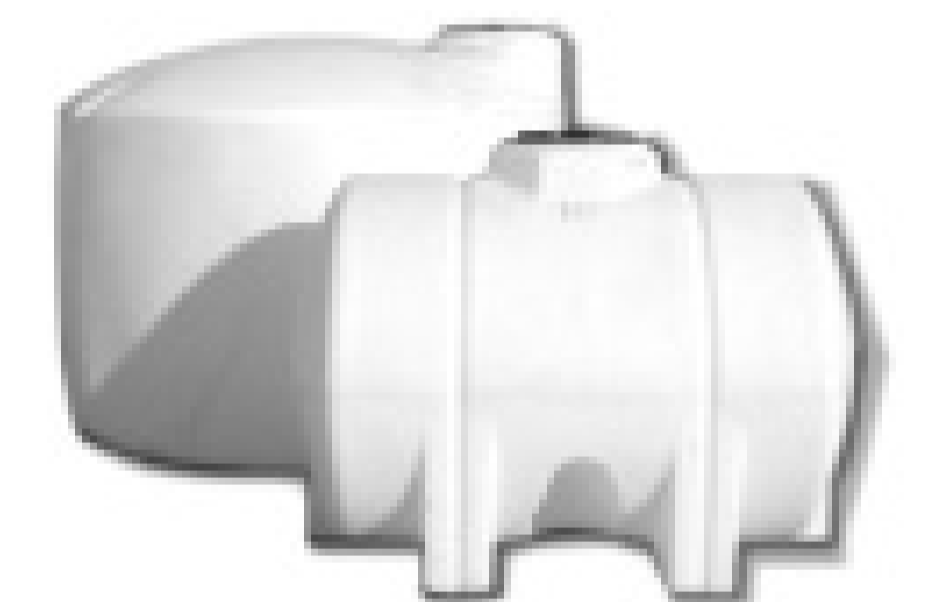

Bulk Storage and Transport Tanks



Septic and Cistern Tanks



Ball Valves and
Cam Lock Couplers

NORWESCO

Distributor Since 1987

Nationwide Shipping Points

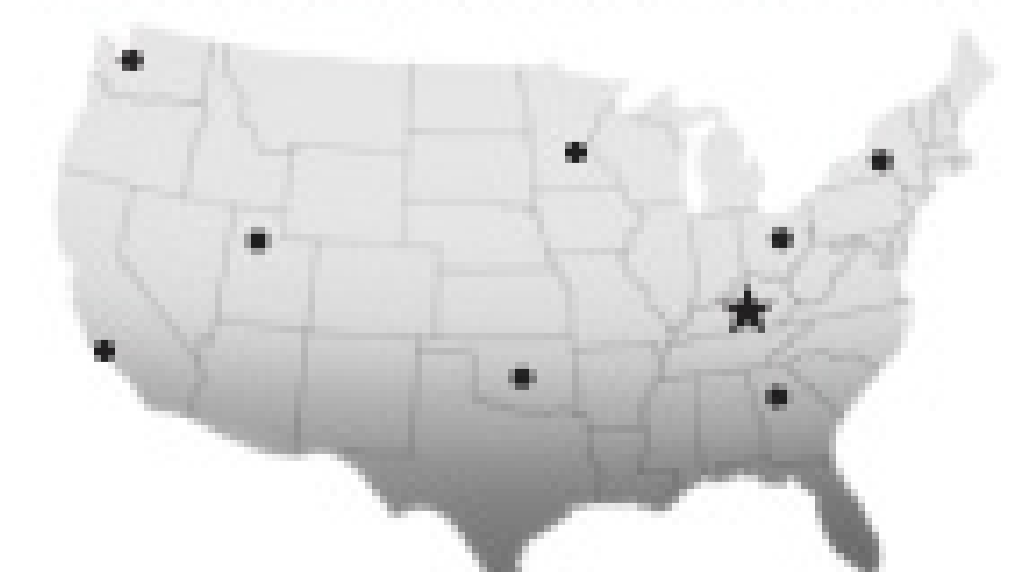

1-888-459-8265

www.kentuckytank.com



"Built to do the work for you."



◆ (1) - 2008 Peterbilt 340 with a PX 8 330 HP and a 10 spd. Eaton-Fuller transmission, 76" dia., 3,150 gal., 5/16" Shell, Full Tilt/Open, with 4" intake, 6" discharge, RCF Fruitland 500 pump

◆ (2) - 2000 International 9100, N14 Cummins (370/435 hp), 470K miles, 10 spd. Trans., 76" dia., 3,000 gal., 1/4" Shell, Full Tilt/Open, 4" intake, 6" discharge, RCF Fruitland 500 pump



◆ ***In Stock*** ◆

ASME DOT 407/412 CODE UNITS

Mounted on a new or used Peterbilt, International or Freightliner

◆ 6 in stock - 76" dia., 3,000 gal., 1/4" Shell, Full Tilt/ Open, ready to be mounted*

Call for quotes * Tanks can be shipped.



MANUFACTURER OF DOT 407/412 TANKS

*For more information
contact L.C. Sutton*



Global Vacuum Systems, Inc.

32804 US 290 West

Hockley, TX 77447

Toll Free: 800-843-0866

Email: info@globalvacuumsystems.com

Web: www.globalvacuumsystems.com

Amthor is Tough

Looking for a new tank? Think Amthor.

At Amthor, we deserve our reputation for quality, innovation and expertise. Our products meet the demands of today's consumer AND exceed industry expectations. With a nationwide distribution network, delivery is simplified. And, you'll enjoy exceptional customer service.



Amthor Matador

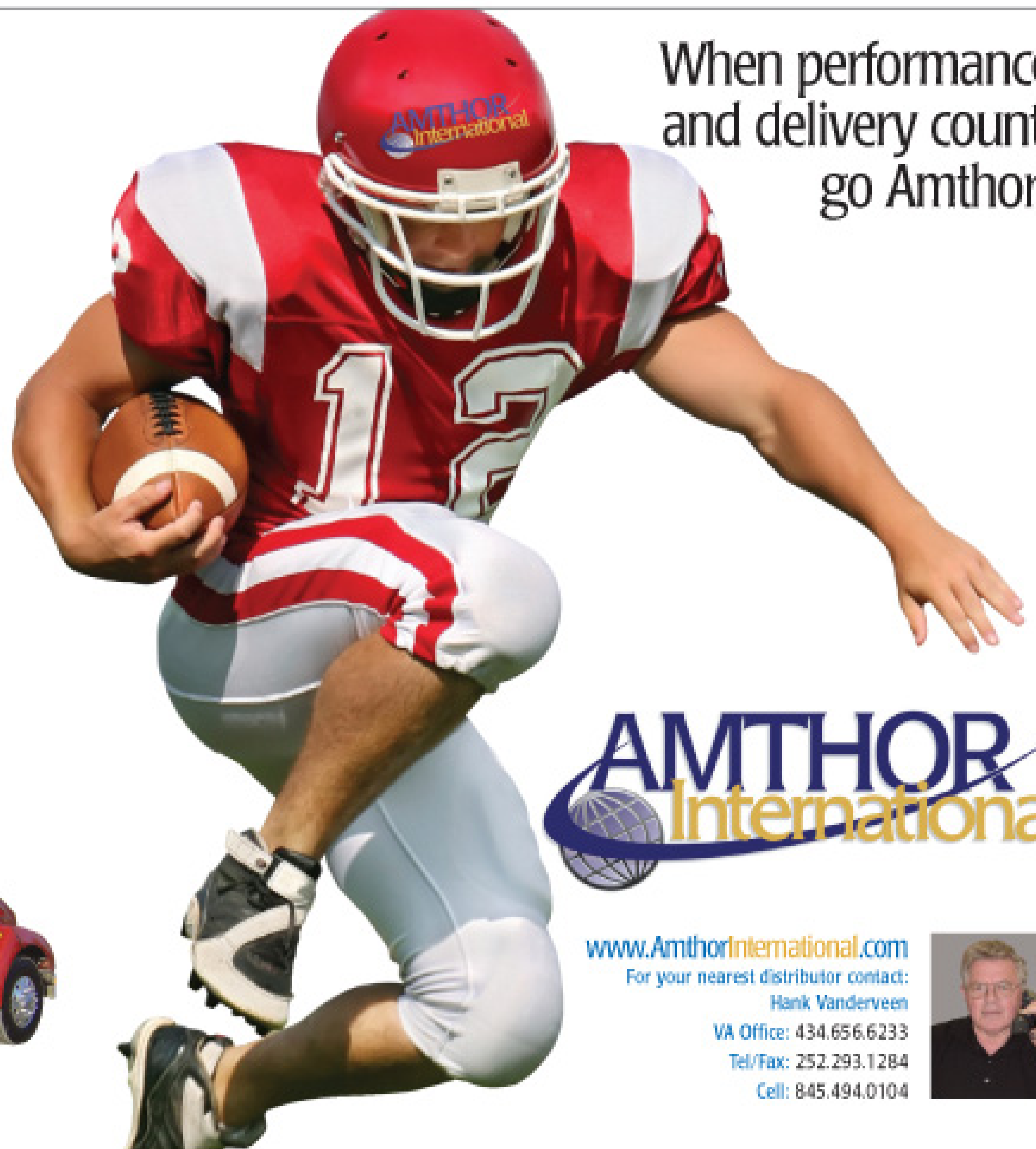

When performance and delivery count, go Amthor!



www.AmthorInternational.com

For your nearest distributor contact:

Hank Vanderveen

VA Office: 434.656.6233

Tel/Fax: 252.293.1284

Cell: 845.494.0104



Irrigation fittings are for irrigating – NOT vacuum.

How many dollars are you spending

SUCKING AIR?

Industry-proven, quality vacuum couplings from Bandlock will put money into your pockets.



4" to 12" Male Coupler



Steel Crown 4", 6" and 8" Press End

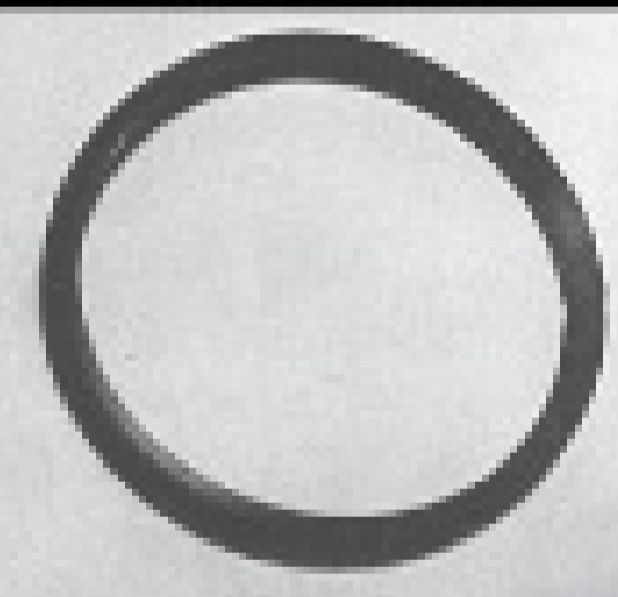

Hazardous Material Profile Gaskets (Safety)

Recognized as the **#1 Relief Valve in the World**

CLOSE TOLERANCE COUPLERS AND FITTINGS BRING "SAFETY" TO YOUR WORK PLACE.

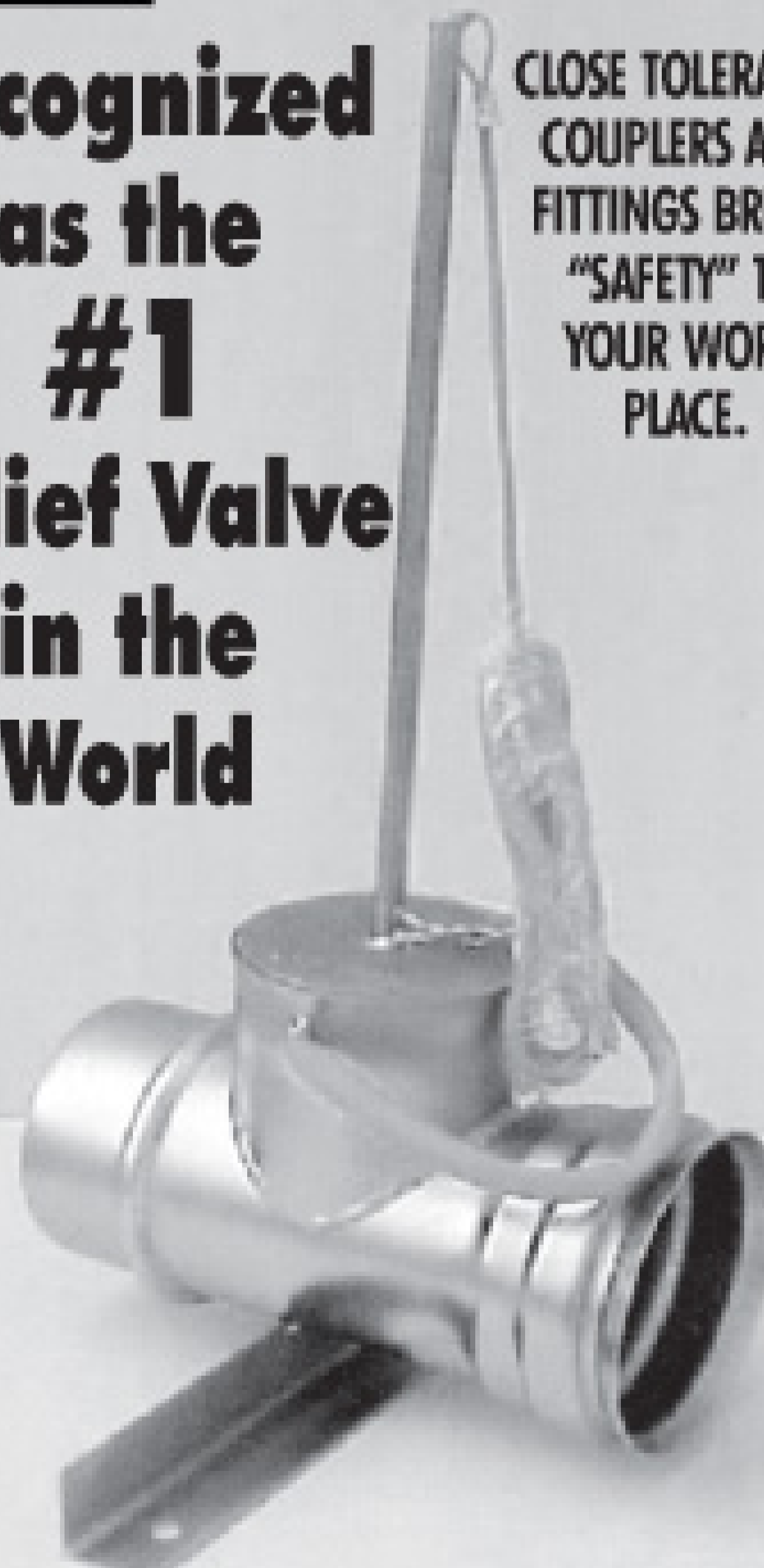

Special "Y" Reducers



BANDLOCK "Y"'s



Aluminum & Steel Pipe

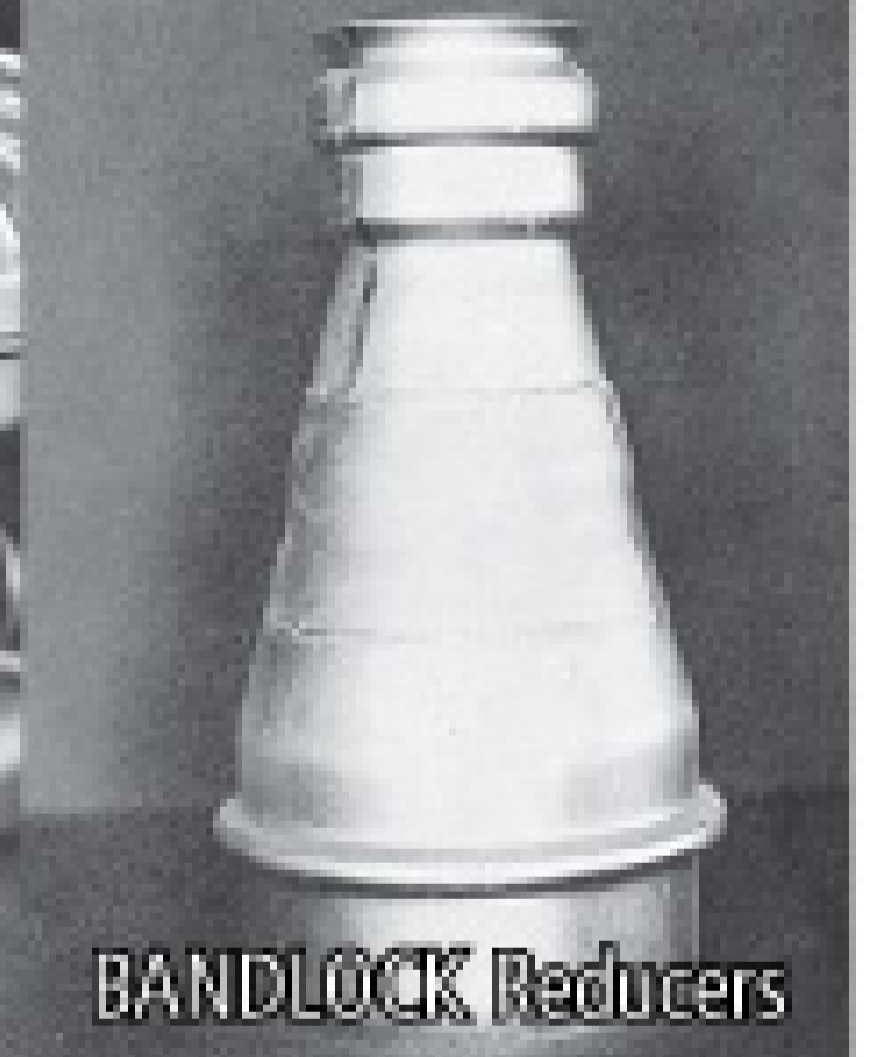

BANDLOCK Reducers

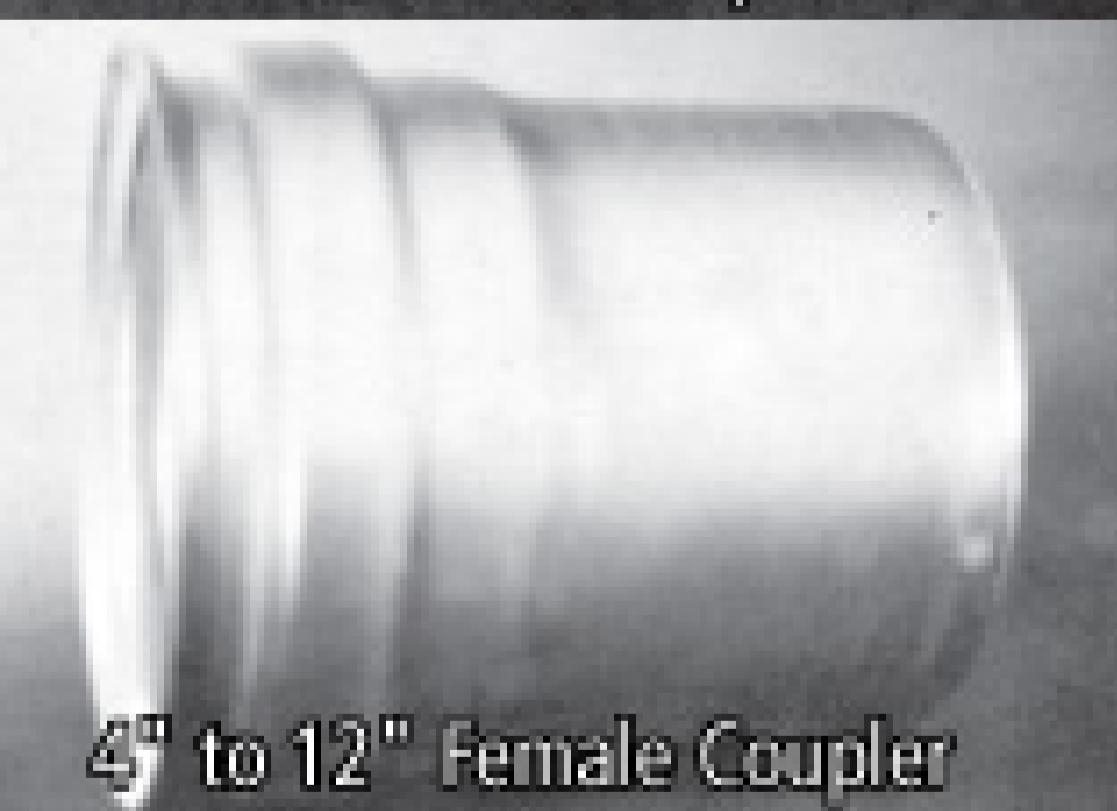

4" to 12" Female Coupler



4" and 6" High Aluminum Bulk Nipples



Rubber Gaskets



Wet Valve, 6", 360° Injected



Male and Female 4" to 12" End Plugs

BANDLOCK Corp.

MADE IN THE U.S.A.

Call or fax today to get your catalog!

1-800-659-2978

Fax: 909-930-2551

www.amesbury.com

SUPERIOR "QUICK" CONNECT VACUUM AND PRESSURE COUPLINGS AND ACCESSORIES



EZ Lift Clamps



Standard & Intnl 4" to 12"

Experience the raw power of...

SURCO®

BLUE • MUSCLE™

THE MOST POWERFUL PORTABLE TOILET DEODORANT IN THE INDUSTRY

Stock up and Order Today!

1-800-556-0111

or on the web at:

www.surcopt.com



SURCO®

- Since 1946 -

292 Alpha Drive • Pittsburgh PA 15238

1-800-556-0111 412-252-7000

www.surcopt.com



©2008 SP

Our Green is REALLY GREEN!



1790 Sun Dolphin Drive • Muskegon, MI 49444
 Phone: 231.830.8099 • 866.293.1502
 Fax: 231.739.2131 • www.fivepeaks.net

Our commitment never ends! Five Peaks Technology continues to "Lead the Evolution in Portable Sanitation" through exemplary dedication and commitment to a safe and healthy environment. Our strategies include recycling our plastics, recycling our packaging materials, refined purchasing habits towards recycled products, and extensive energy audits throughout our plants.

This commitment to our industry is further exemplified in our quality products. The Five Peaks product line includes the popular and stylish Aspen and K2 (available in standard, flushing and elite models), the Matterhorn (ADA Compliant), inside sinks, portable hand-washing stations, sanitation products & accessories, deodorizing products, and service trucks. Please join us as we continue the path towards a GREEN ENVIRONMENT.

Call us today 866-293-1502, for assistance with all your portable sanitation needs.



We believe we build the best vacuum truck in America and every truck we build sets out to prove it.

Can't afford a complete new truck, GWco can refurbish your current truck. Whether you need a new tank, new pump system, or just a new paint job. We can do it. Call us.

We've got the experience and the expertise.



Since 1957
Glendale Welding Co.
 6725 N. 57th Drive • Glendale, AZ 85301
 623-937-7414 • www.glendalewelding.com

You need a new truck chassis.

What do you want from your truck supplier?
Quality... Reliability... Dependability.... Trust... Service



MCCANDLESS INTERNATIONAL TAKES THESE WORDS SERIOUSLY.

McCandless International features the complete line of International Trucks. And we have the financing to streamline your ability to get out on the road. Today, it's easier and faster than ever to get approved financing, so give us a call.



McCandless International of AZ
 2202 S. Central Avenue • Phoenix, Arizona 85004
 1-877-954-9241 toll free • www.mccandlessaz.com

H G N Q M I P M I V G E T G E J G W V P T E O G
D I L K L N K O D R P J V O R C A A B C K X Q A
C F N F S N O U K E B Q V P T D L S E J K I K V
E J K N Z O G T G L K N U N I I B T N T X E C P
J S Q E O A P A R T S P L A C E R N A N W B L E
Q E U C X V B I K O C F N F L X E E T U C E B S
K L I T V P A N F N W F E D I A I I B T C R V
F E D I R E C T D E A L E R N E T W O R K T E J
B C K B F S U A I X S K A I T V H Y N K N W F E
E T G E J V O R C V T O T E R L E V W T G E F N
C I C U S C O P V C E L A T X E Q P I O N E E R
T O B O A E Q S C T Q E E A N A U A D P C A J I
A N E G C T K A C A U C J I A D I R E F L T Q E
R E S O U R C E T V I P Q N T E P P D L S E J X
U C S C G E L I F N P L P M I R O E G C T K A K

KEY: Innovative Selection
Direct Dealer Network Quality
Leader Nationwide
Resource Wastequip

If innovation in the industry is a priority to you, might we have a word?

There is a word for a company that offers truly innovative thinking for businesses in the waste handling equipment industry — **Wastequip**. This is a company with the foresight to make available the best products and selection in the wastehandling industry all under one roof. That alone is impressive. But what they can offer goes even further than that. Partner with Wastequip and you get a business supplier and a company resource and both are ready to assist you fully. It is innovative thinking like this that supports and streamlines your business while helping to increase your bottom line. And isn't that the last word in growing a business? *One call, one relationship, one name...Wastequip.*

1.877.GOT.WASTE
www.wastequip.com



WASTEQUIP

Nationally known for personal service

CUSCO



"The Right Solution"
Complete line of Liquid Waste
and environmental equipment.



Take Charge — Become a Responsible Management Entity

By Tom Ferrero

The Water Environment Research Foundation, or WERF, funded research that identified business characteristics common among 15 successful Responsible Management Entities, or RMEs. The 72-page report, *Business Attributes of Successful Responsible Management Entities*, provides guidance to businesses and organizations interested in becoming RMEs. Your definition of success and the authors' probably differs. They found that successful RMEs had:

- technical expertise in treatment technologies through staff or subcontractors;
- expertise to manage all RME business aspects professionally;
- the customers or financial backing to afford professional management and business staffs;
- a governing body that set policy and a professional staff that made the decisions for long-term survival.

Translation: Successful RMEs are certified in operation, maintenance, and inspection through recognized training courses. They limit the types of treatment systems they operate to three or fewer to simplify construction, operation, and maintenance by minimizing inventories on spare parts and training requirements. Successful RMEs are comfortable with these systems and use them repeatedly. Performance reliability is key, says the report.

Successful RMEs have full managerial capabilities that include a paid manager, someone who collects from the 5 to 10 percent of customers who don't pay, and one or more individuals responsible for the RME's formation and early growth. The report states that the founder was often quite passionate about the use of decentralized systems as a way of addressing groundwater pollution from failed onsite systems.

Successful RMEs have full financial capabilities that include a long-term financial plan, a strategy for long-term growth, enough money to be self-sufficient, a sustainable monthly charge and an independent financial advisor. Researchers found that most RMEs don't start out with sufficient customers to make them financially viable, so they grow their way to financial viability. However, customers resist paying more than \$40 per month for sewer service. The kicker is to develop a large enough customer base to cover administration costs while keeping the monthly charge at, ideally, \$30.

The sustainable monthly fee must cover all expected costs, yet one common mistake RMEs made was equating it with only the cost of operation and

maintenance. Long-term management also includes such items as sampling and testing, replacing failed mechanical equipment, taxes and bonds, franchise fees, and profit. Failure to account for any of these can be disastrous, because the cost is often a large lump sum.

As we know, RMEs can't operate unless the public accepts the need for long-term maintenance and is willing to pay for it. That requires continuous public relations, and the presence and enforcement of onsite regulations. Enforcement means installers and homeowners operate under the same rules, which punish those who ignore their onsite problems or profit from shoddy or incomplete installations.

However, the job of many local health department regulators has become too big. Successful RMEs have gotten around that issue by operating as a regulated public utility, developing

close relationships with regulators, or operating as a special district or zone developed to take responsibility for onsite systems.

The report concludes that the decentralized industry would benefit from focusing more on financial and managerial issues, and less on debates about the

“THE REPORT CONCLUDES THAT THE DECENTRALIZED INDUSTRY WOULD BENEFIT FROM FOCUSING MORE ON FINANCIAL AND MANAGERIAL ISSUES, AND LESS ON DEBATES ABOUT THE PERFORMANCE OF COMPETING TECHNOLOGIES.”

performance of competing technologies. The success of RMEs depends mostly on management, acceptance of the venture by the public, and sound financial planning. The report, Project No. 04-DEC-4SG, is at www.ndwrcdp.org/publications/index.htm.

The next WERF research project, which ends in June 2009, focuses on how to become successful RMEs. NAWT was asked to be one of the reviewers. It's encouraging to see WERF recognize the role of pumpers, and we are going to push to keep it that way.

RME ROAD TO SUCCESS STARTS HERE

It's no joke. Knowledge is power — the power to grow your business responsibly and professionally. The power to improve your company image in the community and with regulators through nationally recognized certification. Join the hundreds of others who have accepted the challenge to grow through learning at an upcoming NAWT training session. Check out future training sessions in the Training and Education listing in the Association News feature in this issue of *Pumper*. ■

Join NAWT Now!

- Independent Member (\$150)**
- Company Member (\$300)**
- Associate Member (\$300)**
- State Association Member (\$100)**

Be a part of the pride and professionalism that all NAWT members enjoy!

Contact NAWT today:
1-800-236-NAWT (6298) Fax 267-200-0279
www.nawt.org

T **RANSWAY** *SYSTEMS INC.* **PROFESSIONAL VACUUM EQUIPMENT**

Toll-Free: 800-263-4508

DELIVERY SERVICE
AVAILABLE

T: 905-578-1000
F: 905-561-9176

314 Lake Ave. North
Hamilton, Ontario L8E 3A2

WE PAY BORDER CROSSING CHARGES • LEASING? WE CAN REFER YOU TO THE SPECIALISTS • OVER 40 YEARS IN BUSINESS

HEAVY-DUTY EQUIPMENT THAT WORKS!

**LET 45 YEARS
OF EXPERIENCE
WORK FOR YOU !**





CIRCLE D TRUCK SALES

www.circledtruck.com

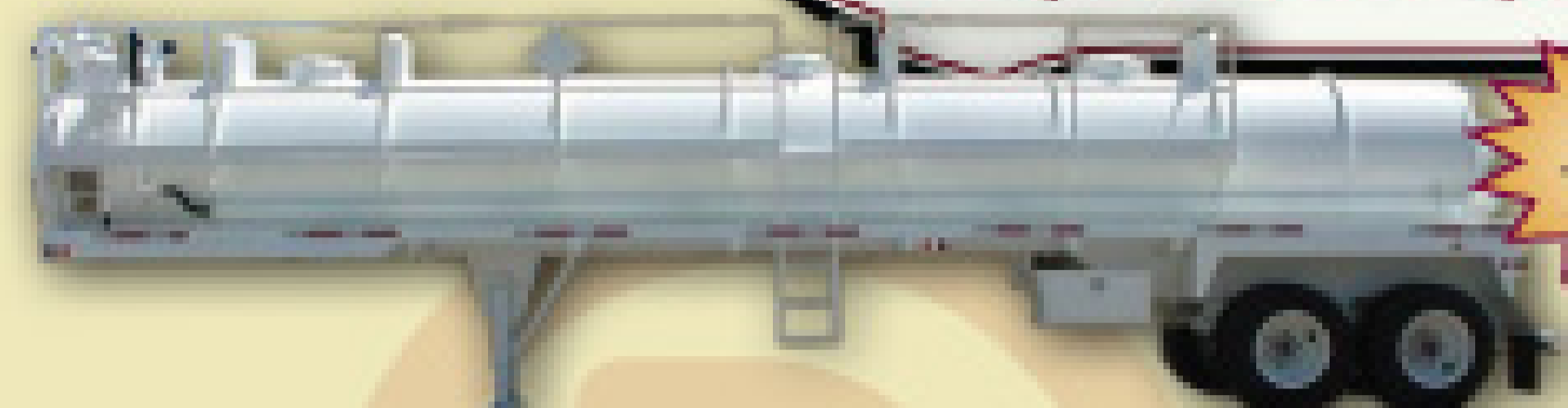

READY TO HAUL

NEW 2008 130BBL (5460GL) DOT 407/412 ASME VACUUM TRAILER. Spring suspension, 11R24.5 tires. Full length walkway with handrails, (2) -4" butterfly valves with air to open spring to close at rear, (3) -20" diameter DOT certified National Vacuum domed man-ways, (1) 20" diameter DOT verified National Vacuum domed man-way located on lower rear head, 12" heavy duty DOT internal shut-off at top front of tank, Outside scrubber with dome lid and 2" drain, Girard 3" relief valve, Front, Center, and rear overturn protection, External arrow rotary float gauge with 8" stainless steel float ball, 18"x18"x36" toolbox with locking latch (2) work lights with on/off switch located at rear. **Call For Price**



VERY NICE!

2005 MACK VISION CX613, AC-427 Mack 427 HP, 10 Spd OD, Engine Brake, Air Ride Suspension, 3.58 Ratio, 223" WB, Aluminum/Steel Wheels, 450,050 miles, NEW 2008 BULLDOG Vacuum Tank, 3360 Gallons (80BBL), 1/4" Head & Shell Thickness, Primary & Secondary Shutoff, (2) Top Man Ways, (1) Rear Clean Out (2) Internal baffles, Sump With (2) 4" Rear Outlets With Wafer Style Butterfly Valves, Front Sight Glass, Vacuum & Pressure Relief Valves, Full Length Hose Trays, Rear Bumper, JUROP R260 Vacuum/Pressure Pump With Pump Stand, Right Angle Drive. Stk. #2091 **\$92,500**



VERY NICE!

2008 TROXELL 130bbl. Vacuum Trailer, non-code, 4 Spring Suspension, Steel Composition, 24.5 Tires, All Steel Wheels, Tandem Axle, Steel Composition, 5460 Gallons, 1 Compartments, Full length walkway with Tool box, (2) 4" butterfly valves, scrubbers, Full length hose trays. Ready to haul!! \$1500 for Optional Belly Line. Stk. #1906. **Call For Price.**



VERY NICE!

2006 FREIGHTLINER FLD12064SOT, 186K miles (Actual miles), MBE 350HP, Allison 4500 RDS, 40,000lb RA, 12,000lb FA, Air ride suspension, Engine Brake, 4:63 ratio, 202" WB, 127" CT, Dual 80gl. Aluminum fuel tanks, Cruise, AC, PS, AM/FM stereo, Chrome exhaust, "NEW" Presvac DOT-MC MC 412, 3150 Gallon, Tilt With Full Open Rear Head, 4" Load Line With Riser, 6" Discharge, Catwalk With Handrails, Fruitland RCF 500 Vacuum Pump. Includes FET VERY NICE!!! Stk. #2287 **\$154,750**

Available Soon: 1992 Volvo w/Vactor unit, good spec's, being refurbished - Call for price!

MORE TRUCKS AND TRAILERS AVAILABLE, IF WE DON'T HAVE IT WE'LL FIND IT!

**Lee Dill, Richard Roberts, John Trammell, Gary Chandler
CIRCLE D. TRUCK SALES**

**4502 E. OVERLAND TRAIL • ABILENE, TX • 79601
325-677-0474 • FAX: 325-673-7207**

888-433-0474

IN STOCK



2003 MACK CH613 E7-427HP, 10 speed, 573K miles, Mack Air ride suspension, 3:90 ratio, 40,000 lb. RA, 12,000 lb. FA, 11R22.5 tires, Chrome exhaust, Tilt/telescopic wheel, Cruise, AM/FM stereo, AC, PS, "NEW" Presvac DOT-MC MC 412, 3150 Gallon, Tilt With Full Open Rear Head, 4" Load Line With Riser, 6" Discharge, Catwalk With Handrails, Fruitland RCF 500 Vacuum Pump. VERY NICE! Stk. #2312 **\$118,500**

Gasoline Hot Water Unit With Hose Reel

Aqua Blast has several models within the Gasoline Hot Water category, including Jetters. Our units range from 1600 to 10,000 psi at 3 to 10 gpm and have an adjustable hot water thermostat.

AQUA BLAST also offers the following styles of units with 900 psi to 30,000 psi and 2 gpm to 500 gpm.



Central cleaning systems with the installation of plug-in stations for hoses.

- Electric, gas, diesel or propane
- Truck, trailer or skid mounted, portable
- Hot, cold or steam

AQUA BLAST™ Manufacturer of High Pressure Cleaning Systems

800-338-7373 • 260-728-4433 • Fax: 260-728-4517
E-mail: davidt@aquablast.com • www.aquablast.com

Introducing the Most Durable and Economical Septic Lid in the Market Today.

Cost Effective
6 Pack Shipping

Now Offering
Custom Lids!

- Durable Roto-Molded Construction WILL NOT Crack Like Concrete!
- Lightweight Polymer is Easier to Handle & Transport
- Corrosion Resistant Stainless Steel Screws Included
- For use with Standard 18" and 24" I.D. Corrugated Pipe
- Easy Slide-in Installation
- Optional Sand Filled



800.868.0973

Don't Waste Money On Expensive Riser Systems!



“I’ve gone Global”



In 2005 K. Hoving Companies first entered the portable sanitation business. **Today** K. Hoving has a fleet of 1000 Global restrooms. Hoving chose the Global for its strength, durability, value and the one of a kind Dirt Buster Base. Hoving's portable sanitation business is thriving and will continue to grow with the Global.

K. Hoving Companies has gone Global. Have you?



Hampel

Engineered for strength, durability and value.

www.hampelcorp.com • 800-549-1558

1-YEAR, 100,000 MILE ENGINE WARRANTY NATIONWIDE • COMPARE OUR TRUCKS AND PRICES TO ANYONE



2003 INTERNATIONAL 9200
4800 Gal US Tanks, Jurup LC 420 Water Cooled, Double Frame



2000 FREIGHTLINER
2200 Gal US Tanks, Jurup 260 CFM, Aluminum Wheels



2005 MACK VISION
4000 Gal US Tanks, Jurup LC 420 Water Cooled, Double Frame, All New Tires



2002 MACK VISION
3800 Gal US Tanks, Jurup LC 420 Water Cooled



2005 MACK VISION
3600 Gal US Tanks, Double Frame, Jurup LC 420 Water Cooled



2005 MACK VISION
4000 Gal US Tanks, Double Frame, Jurup LC 420 Water Cooled

OUR 28TH YEAR
NATIONAL TRUCK CENTER

Please Call For More Info

9750 N.W. 27th Ave. | Miami, FL 33147 | Phone: 305.691.8407 | Fax: 305.691.8416

ISRAEL VERA: GEORGE GONZALEZ:
305-525-6406 954-558-0816

www.nationaltruckcenter.com

★ **WE EXPORT OR DELIVER** ★

U.S. Tanks

THE TOP DOG OF VACUUM TANKS

When Service Life is Important,
Get the 25-Year NO Rust Guarantee

- Dewatering Systems
- Composting Systems (ECS)
- BOD COD Reduction Systems
- Polymer Systems
- Financing Available

**It's Smart to Protect Your Investment,
Get the SMART 25-Year Guarantee!**



Multiple Purchase Options Available with Financing

If you want experience, give John a call.

1-800-899-1802

P.O. Box 782265 • San Antonio, TX 78278

210-269-3910

www.smartdewatering.com

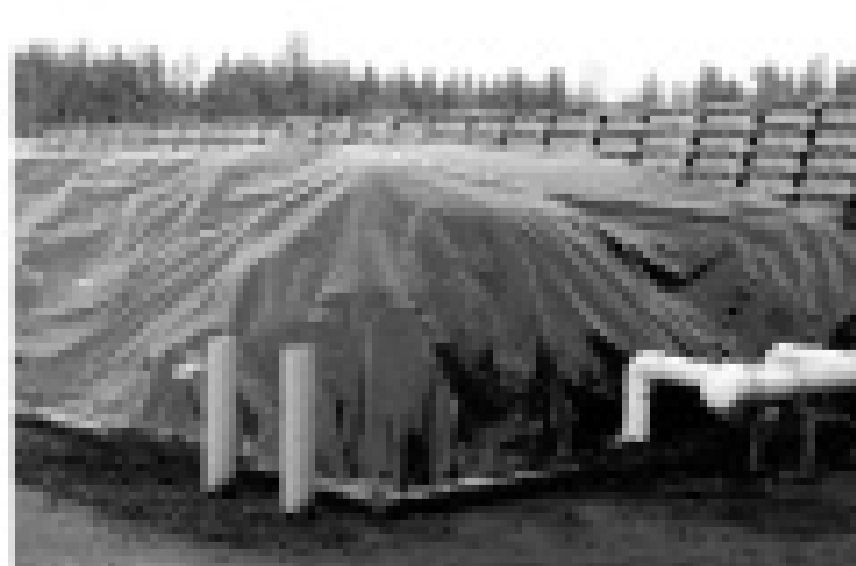

Simple Solutions
DISTRIBUTING LLC
MAKERS OF
Wolverine Brand™
ODOR CONTROL PRODUCTS

Custom Built For Any Application

Plumbing Vent Filters Lift Station Adsorbers
Pollution Control Barrels Manhole Odor Filters
Vapor Phase Adsorbers In-Flow Protectors

We Stop The Stink-GUARANTEED

866-NO-STINK 973-846-7817
www.Industrialodorcontrol.com www.stopsepticodor.com

PayPal

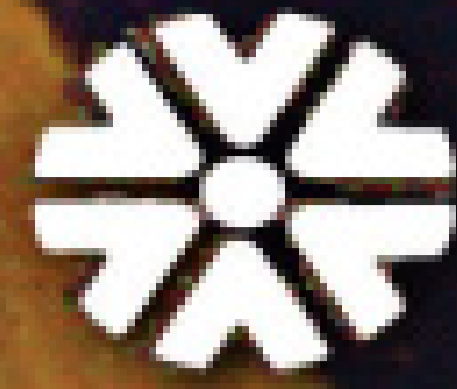

CENTER CAPITAL CORPORATION®

A Webster Bank Company*

Financing geared toward your business success.

THE INTELLIGENT CHOICE

FOR INNOVATIVE FINANCING SOLUTIONS

Environmental Equipment Financing Division

Financing Geared To Your Business Success!

The Intelligent Choice For Innovative Financing Solutions

Center Capital's Environmental Equipment Financing Division offers equipment leasing and financing services tailored to the unique requirements of the waste management and environmental industries. Unlike traditional lenders, our sales team has expertise in both financing and waste management. We understand the kind of payment plans that make sense for your industry. We understand the equipment. We understand the day-to-day business issues you face.

When you work with Center Capital, you're partnering with professionals who understand your business and what it takes to help it grow.

We Cover 50 States!

PAYMENT PROGRAMS

STRUCTURED TO FIT YOUR NEEDS

VENDOR VALUE-ADDED

PROGRAMS

APPLICATION PROCESS

SIMPLIFIED

MORE INFORMATION

CONTACT

Robert A. Marino
Sr. Vice President

Phone: 800-344-2224 • Fax: 215-542-1307
Website: www.centercapitalcorp.com

*Center Capital Corporation is a Subsidiary of Webster Bank, N.A., Member FDIC

Pacific Natural Energy Corp. Bio-Box

By Ken Wysocky

The **Bio-Box biodiesel fuel factory** from **Pacific Natural Energy Corp.** enables pumpers to economically make fuel from things they'd normally pay to dispose of like grease-trap waste and waste fryer grease.

"This system allows liquid waste carriers who otherwise couldn't make their own fuel to legally produce biodiesel for about \$1.25 a gallon," says Eric McLeod, president of Pacific Natural.

"Because this is aimed at mid-size users, there aren't as many barriers to market entry as there are with building a large biofuel factory."

The system's modular design allows operators to start out small and expand as needed with a series of "plug and play" units. The equipment is delivered and installed inside standard, 20-foot-long shipping containers and, as such, can be kept outdoors or indoors. No special power source is required.

"We offer a total solution," McLeod explains. "Everything is completely contained from the time the system receives waste material from a vac truck to the time it goes back into a truck as fuel."

The system footprint ranges from 2,000 square feet to 10,000 square feet (which includes space for truck access), with tank capacities of 650 to 2,600 gallons. The system is capable of producing anywhere from 400 to 15,000 gallons per day or 100,000 to four or five million gallons annually. It can also include safe storage space for ingredients such as methanol, McLeod says.

"We designed the system for flexibility," McLeod says. "A giant, centralized factory creates logistical issues, like how to

obtain and store large quantities of raw materials, such as methanol. But a smaller, decentralized system eliminates those logistical concerns. We use many small units as opposed to a few large units."

PRODUCT SPOTLIGHT



Designed to convert waste vegetable oil into biodiesel fuel, the complete factory includes storage for raw materials and the Bio-Box reactor, capable of producing from 400 to 15,000 gallons a day.

The Bio-Box can be skid mounted for easy portability as well as expansion. Each system is factory built to customer specifications, and after delivery, can be operational in as little as 48 hours, McLeod says.

"All customers have to do is tell us how much raw material they collect, and we scale the design to their comfort level," McLeod says.

The price is "fairly significant," McLeod says, because it's expensive to make equipment that meets all permit requirements. Pacific Natural obtains all the required permits, which typically cover about a half dozen different federal, state, county and local jurisdictions.

"This is a good solution for operators who are losing profits to higher fuel costs," McLeod notes.

"Not only do they avoid disposal costs, but they can also produce their own biodiesel fuel and sell it at the market rate."

For safety reasons, two employees are legally required to operate the system. Pacific Natural sends technicians on site to teach customers how to operate it, McLeod says. **For more information, call 818/760-2823 or visit www.stopxon.com.**

Tri-County Introduces Soil Shaker Skid-Steer Attachment

The Soil Shaker 2000 skid-steer attachment from Tri-County Septic is designed to

loosen sealed, compacted or non-draining soils in septic drainfields. The attachment enables the operator to penetrate soils using the probe hammer. While in the ground, the attachment releases air, breaking up the compacted soil, restoring the entire drainfield without damage to the lawn. A demonstration DVD is available. For more information: 320/293-6644.; www.soilshaker.com.



Soil Shaker skid-steer attachment from Tri-County Septic

Elastec/American Marine Develops Versatile Vacuum System

Elastec/American Marine has developed a vacuum system that can be towed by an all-terrain vehicle. The unit can reach sites inac-



Vacuum system by Elastec/American Marine

cessible to vacuum trucks. A 3-cylinder diesel engine powers the pump that can generate more than 300 cfm of air-flow and 15 inches of vacuum, enabling it to suck up oils, mud sludge and other liquids. It is fitted with a safety

relief valve, cyclonic separator and exhaust. Both the tank and vacuum pump are mounted on all-terrain tires with walking beam suspension. The components are within the towing limits of most ATV or utility vehicles. Optional tracks can be added for soft ground, snow or sand. The vacuum tank also can be removed from the chassis, enabling it to be used as a trailer for other equipment. For more information: 618/382-2525; www.elastec.com.

Raven Offers Wastewater Process Control Package

The Process Control Package from Raven Environmental Products Inc. is designed for activated sludge treatment plants to obtain operational information in wastewater treatment operations. The package enables operators to determine operational parameters, analyze sludge settling characteristics, sludge detention times, return sludge flow rates and waste sludge quantities. The package includes a laboratory bench-top centrifuge designed specifically for wastewater process control, one Coretaker core sampler, three Settleometers, and a 14-page user's manual. For more information: 800/545-6953; www.ravenep.com.

SJE-Rhombus Introduces D-Master Diaphragm Switch

The SJE D-Master diaphragm switch from SJE-Rhombus is designed for sump pump use in confined spaces. With no external moving parts, the switch features a 10-inch pumping range, 10-foot cord and 120-volt piggyback plug for sump pump connection. For more information: 888/342-5753; www.sjerrhombus.com.

Pump Systems Publishes Guidebook

Optimizing Pumping Systems: A Guide to Improved Efficiency, Reliability, and Profitability from Pump Systems Matter and the Hydraulic Institute is a 250-page reference based on the collaborative efforts of 22 industry experts. The book includes graphics, illustrations and reference tables covering a range of topics, including pump fundamentals, pump and system interaction, calculating cost of ownership, improving the performance of existing pump systems, optimizing new designs and pumping system economics. For more information: 973/267-9700; www.pumps.org.

Bio-Microbics Designs Membrane Bioreactor

The BioBarrier Membrane Bioreactor from Bio-Microbics Inc. is designed to allow high-quality effluent to discharge into most environments, including surface irrigation and other re-use methods. The wastewater system's automated operation sequence requires no backwash, ships installation ready and fits into both new and existing tanks. For more information: 913/422-0707; www.biomicrobics.com.



BioBarrier Membrane Bioreactor from Bio-Microbics Inc.

Liberty Expands Effluent Pump Line

Liberty has expanded its effluent pump line to include larger 1-hp, 1.5-hp and 2-hp models. The pumps feature maximum head capacities of more than 130 feet and flows to 130 gpm. The dual-sized discharge has a 1 1/2-inch removable flange with a 2-inch threaded port for connection to either size pipe. The pump also has a standard 25-foot quick-disconnect power cord and dual shaft seals. For more information: 800/543-2550; www.libertypumps.com. ■

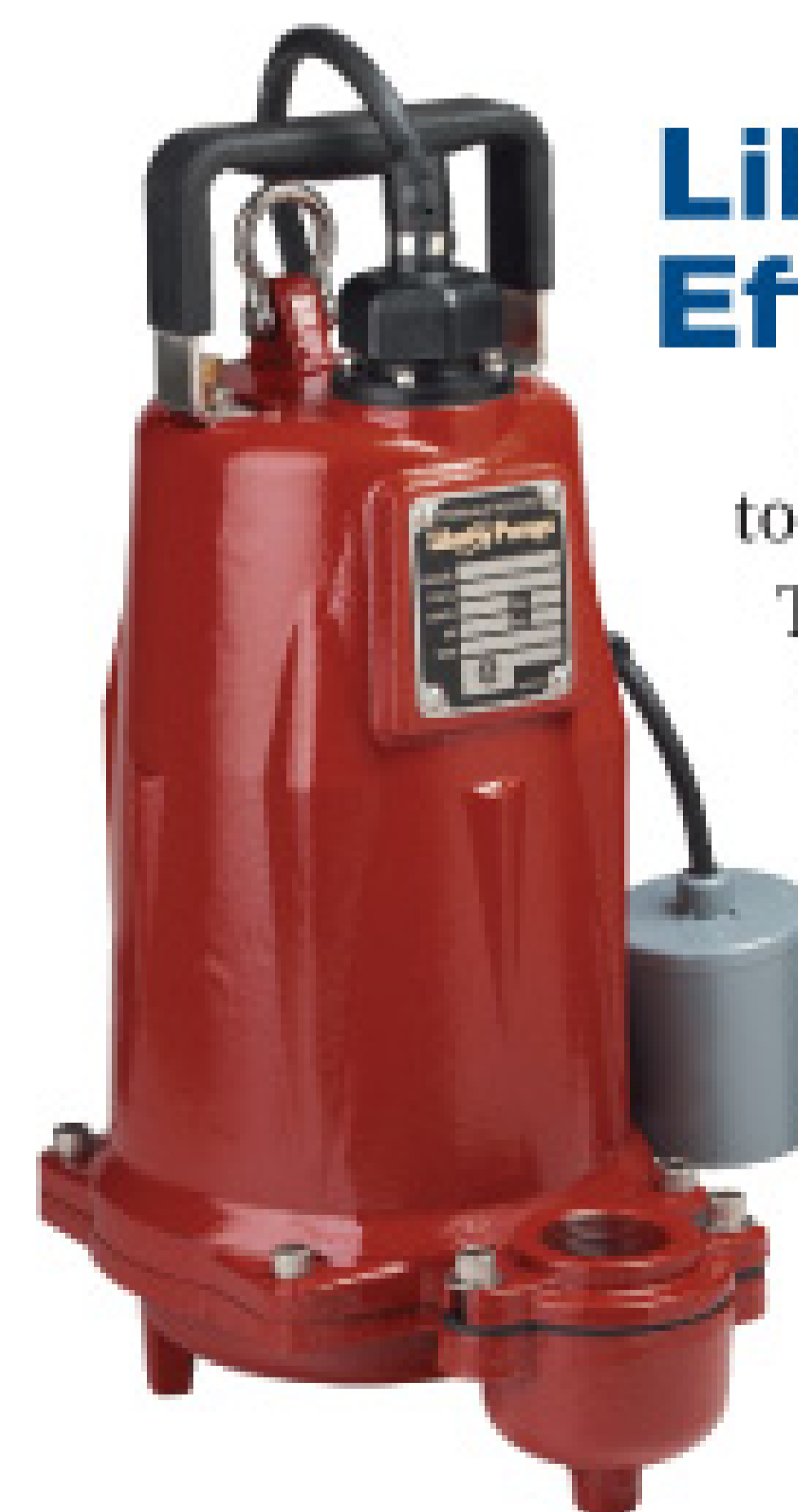

Larger FL series effluent pump line from Liberty Pumps

10280 Brecksville Road Brecksville, Ohio 44141



R.A. ROSS N.E., INC.

INDUSTRIAL & TRUCKING BLOWERS • VACUUM PUMPS • SALES, SERVICE, & INSTALLATION



We have a **FULL SERVICE REPAIR SHOP** capable of servicing and repairing a wide variety of different makes and models of blowers and vacuum pumps from all your top manufacturers including
**Tuthill/MD • Drum • Gardner Denver • Cycloblower • Duroflow • Sutorbilt • Roots • Hibon
 Fruitland • Moro • Masport • Wittig • NVE Challenger • Jurop • Battioni • Presvac
 Blackmer • Roper • Ranger • Viking**

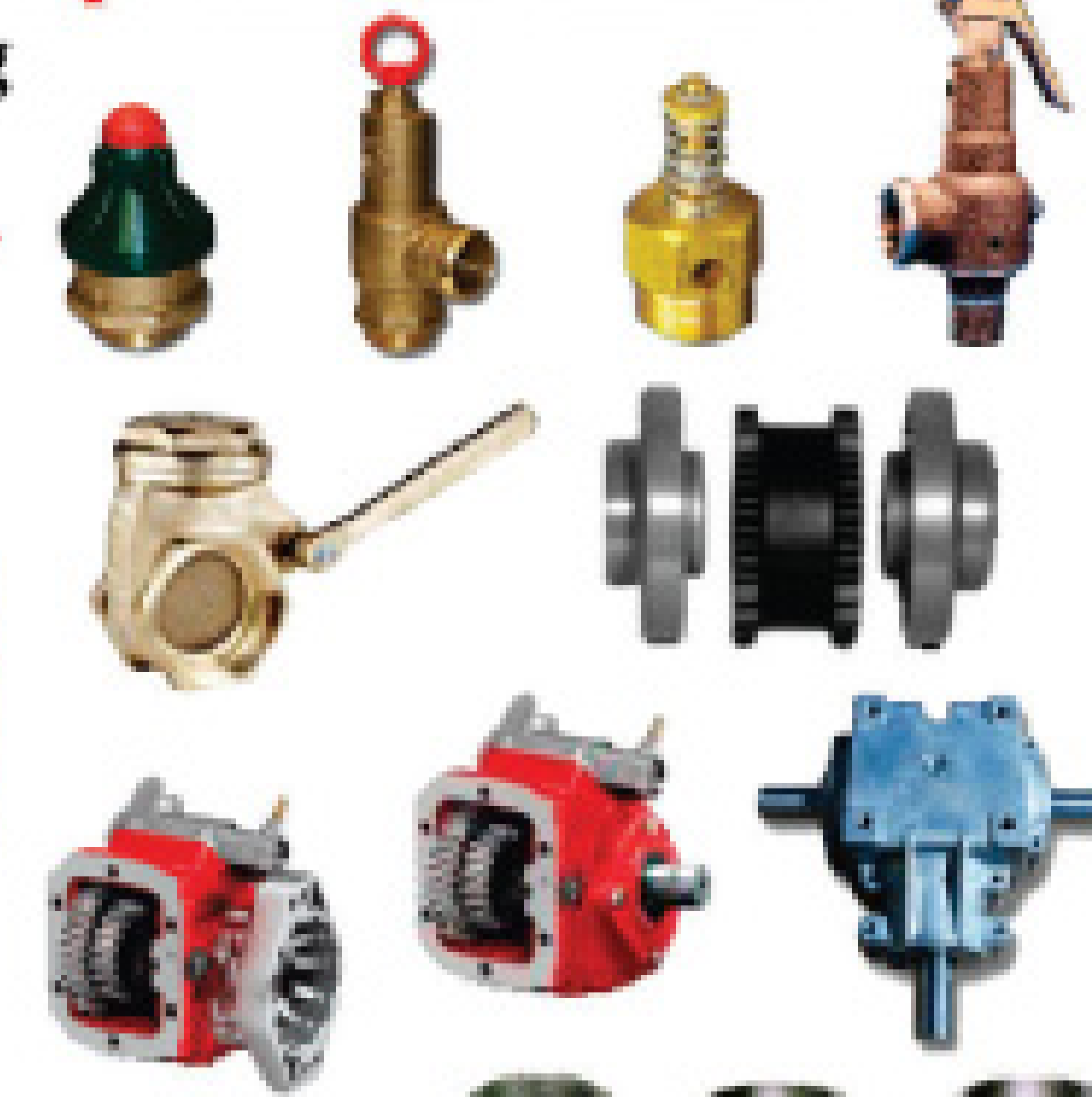

NVE FRUITLAND CHELSEA
 A DIVISION OF Parker



Vacuum Pumps • Components • PTO's • Hydraulics • Valves • Manways • Gear Boxes • Mufflers • Silencers • Gauges • Camlocks • Hose

TOLL FREE 1.800.678.4581 PHONE 440.546.1190 FAX 440.546.1188 EMAIL RAROSSNE@RAROSSNE.COM WEBSITE WWW.RAROSSNE.COM

**"DON'T BE EMBARRASSED AGAIN!"
 HOW AWFUL...**

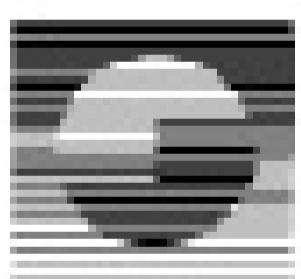

800-622-8768
 sweetair.com

SWEET SEPTIC SYSTEMS, INC.
 5701 Mother Lode Drive • Placerville, CA 95667
 Fax: 530-622-1087

SWEET AIR™ FILTERING DEVICE

HOW WONDERFUL...



Wolf Creek Co.

Original Bauer

Portable Piping

Bauer Fittings

Polybarb™ Pipe & Tails

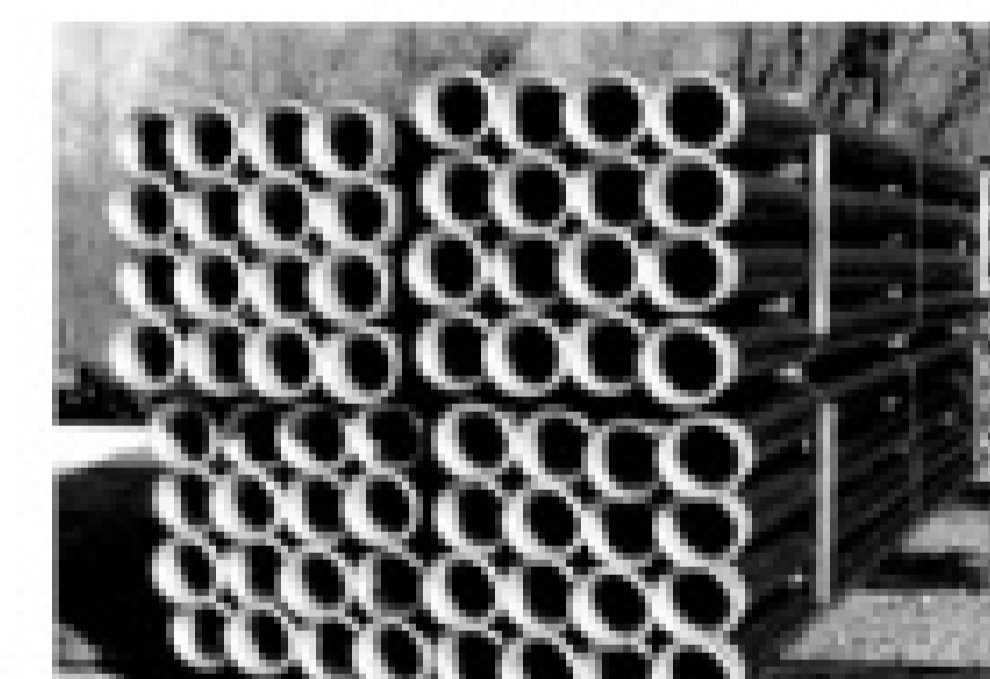

Polybarb™ HDPE pipes and fusible tails available in 4" to 12" diameters up to 40' in length.

Available in weldable, hose insert, and flanged connections. Fittings available from 2" to 12".

Industrial Vac Tubes

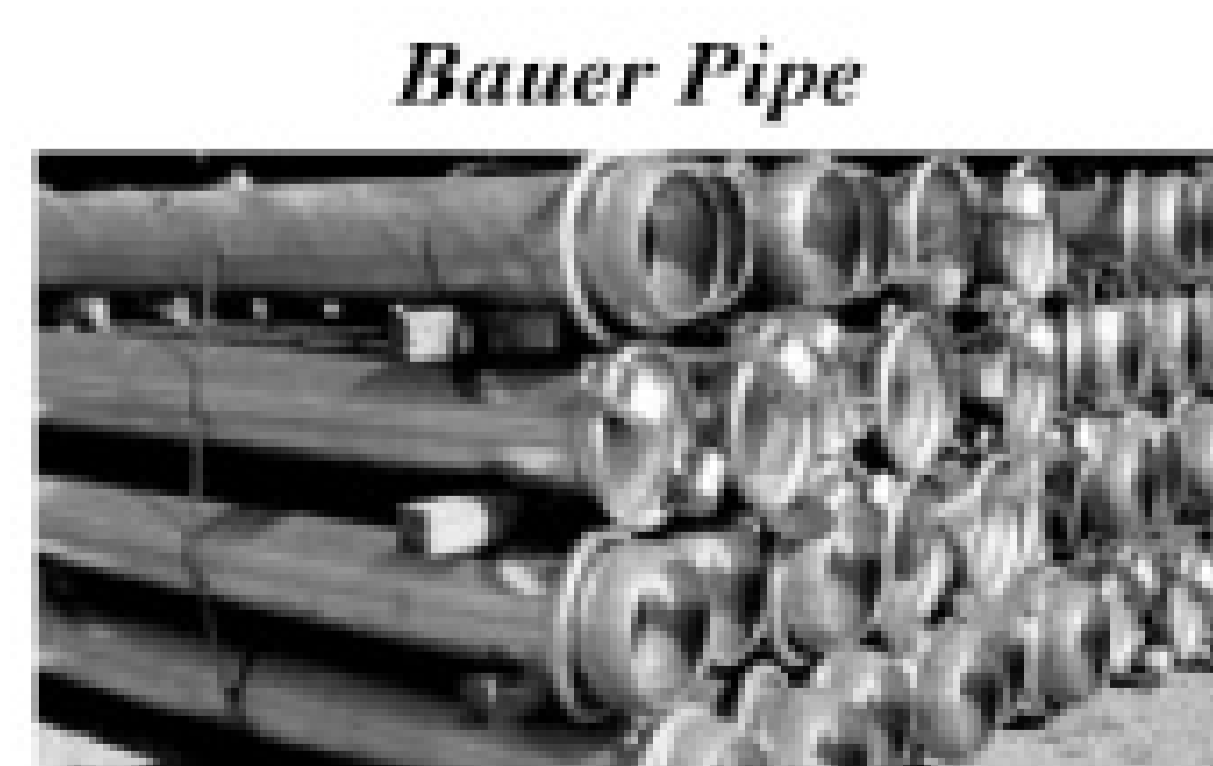

Bauer Pipe

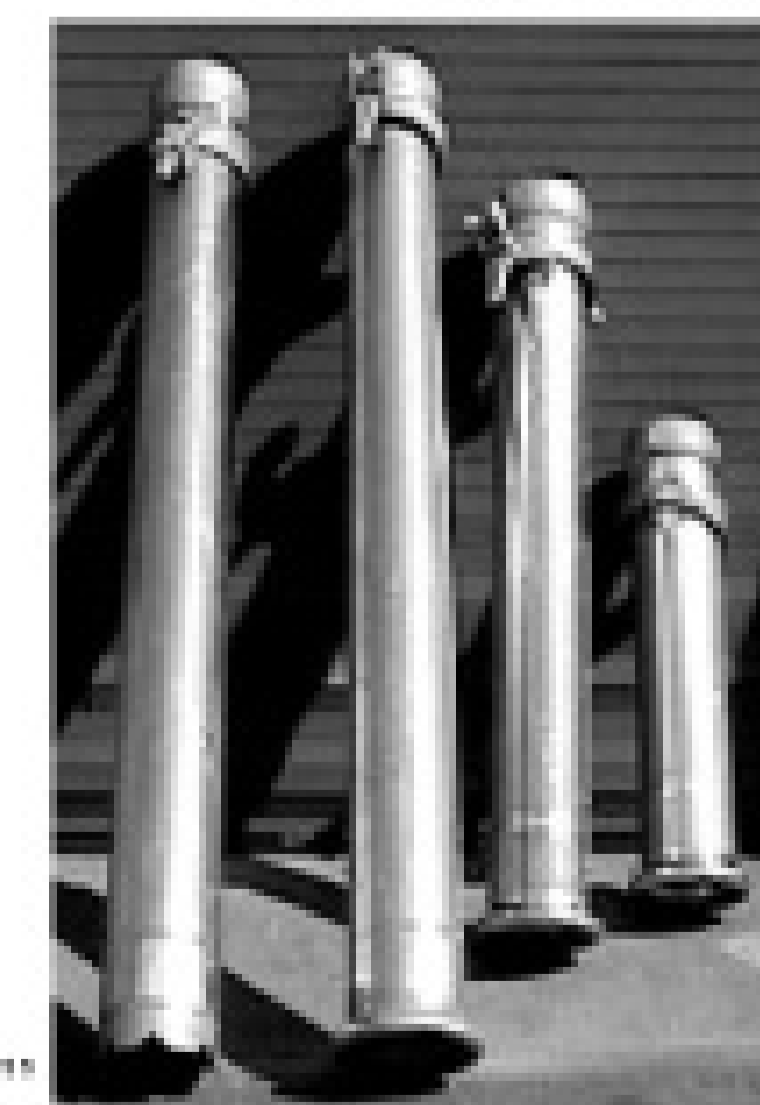

We can fabricate aluminum vacuum evacuation or suction tubes per your specifications. Using the Bauer Coupler or Anfor Coupler.

Galvanized piping available in 2" to 12"

800.488.7305 • www.wolfcreekcompany.com

Advance

PUMP & EQUIPMENT INC



**Custom
Pump
Trucks
Built to
Your Specs**



Single Axle Pumpers
In Stock For Quick Delivery

**Call Today
For
Professional
Blower
Installation**



**In Stock
For Quick
Delivery**



NVE
DISTRIBUTOR

**6000 Gallon
Short Tanker Trailer**

- Excellent for Septic & Grease Trap Service.
- Call for more Information

Less Trips = Less Fuel

Introducing the JT530
\$4,250.00



Toolbox Jetter JT530

- Polished Aluminum Toolbox
- 5 GPM @ 3000 PSI Water Pump With Pulsator
- Electric Start Engine
- Remote Fuel Tank
- Electric Rewind Reel With 200' of 3/8" Hose
- Chrome Guide Rollers On Reel
- Washdown Gun With Quick Connect Tips
- (1) Jet Nozzle
- Stainless Tool Rack

**Add Jetting
To Your
Pump Truck
or Tanker Trailer**

Introducing the JT1030
\$5,995.00



Toolbox Jetter JT1030

- Polished Aluminum Toolbox (28 x 28 x 48)
- 10 GPM @ 3000 PSI Water Pump w/Pulsator
- Gearbox Drive - Standard or optional Hydraulic Drive
- Bucket Fill/Drain
- Air Rewind Reel w/200' of 1/2" Hose
- Chrome Guide Rollers on Reel
- Wash Down Gun w/ (4) Quick Connect Tips
- Jet Nozzle - Flushing
- Includes Mounting Brackets

Toll-Free 1.877.557.PUMP (7867)
"Partners in Performance"

Call For A Quote Today!

www.AdvancePump.com

15418 Old Highway Road • Peosta, Iowa 52068
877.557.PUMP (7867) • Fax: 563.557.0961

We've got you covered



Unit #71134 2000 International Vactor 2110,
Allison Automatic Transmission, Roots 824 Blower
READY TO WORK!



Unit #39622 1999 International Guzzler Classic,
Roots 1024 18" blower, Dana Transfer case
CALL FOR DETAILS!



Unit #42386 2005 International 7600 Guzzler NX,
Hibon NX850 Blower, Ultra Quiet Sound Package
READY TO WORK!

Many More Units Available • Call for Details!

**Parts and Service
Financing for Used Equipment and Service
Warranties for Most Equipment
We Sell and Service**

**The Largest Selection of Refurbished
Vacuum Trucks in the World**

1-800-822-8785
www.fssolutionsgroup.com

Toll Free 888-207-2074

Fax (479) 770-6089

WILCOX TRUCK SALES, INC.



Lowell, Arkansas

... ESTABLISHED 1978

I-540 Exit #78 & Hwy 71B

2 hours East of Tulsa or 1.5 hours South of Joplin

www.wilcoxtrucksales.com

1997 International 9300

In Process of New 80
Barrel Vacuum Tank,
New Jurop R260
Vacuum Pump, 3406E
Cat, 18 Speed, 470 HP,
3 Stage Engine Brake,
244" WB, Cold A/C, New
Sumitomo Steer Tires



1981 Proco

130 Barrel Vacuum Tank
Trailer, 40' Steel, (1) 5460
Gallon Compartment,
Recently Sandblasted and
Painted, Exterior Ring,
22.5 Tires on Budd
Wheels



RouteOptix Inc.

- Customer Service
- Optimized Routing
- Visual Dispatch
- Asset Management
- Disposal Tracking
- Customer Billing

A Complete Software Solution

(866) 926-7849

www.routeoptix.com

info@routeoptix.com

PERFORMANCE. YOUR NAME DEPENDS ON IT!

The Aero-Stream® System for septic repair and maintenance



**Give your customers peace of mind
and put yourself at the top of their list.**

Making customers happy is the best way to build your business. And that's exactly what our revolutionary septic remediator can do. **Easily installed in an hour or less,** the **Aero-Stream® System** is designed to both restore and maintain conventional septic systems without the hassles, damage and high costs associated with yesterday's solutions. **It's simply the best way to fix septic problems and prevent them. GUARANTEED.**

Add the **Aero-Stream® System** to your arsenal.

- Create a new profit center
- Build your reputation as a solutions provider
- Gain customer loyalty by providing a cost-effective solution

 Patented system,
UL listed outdoor appliance



Visit www.aero-stream.com or call 877-254-7093



CAPITAL RUBBER CORP

Get Connected.

**YOUR SOURCE
FOR ASSEMBLIES AND MORE!**

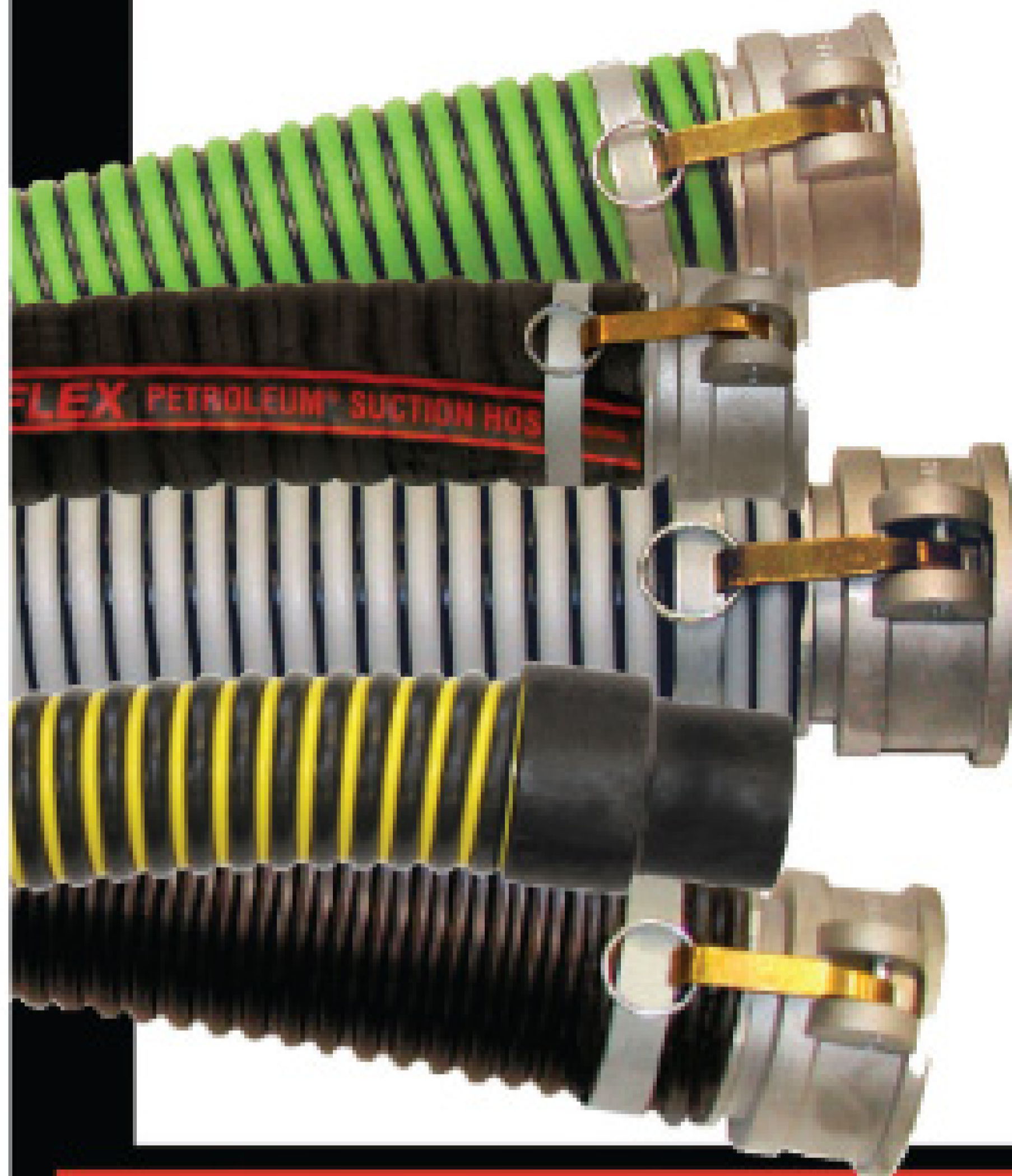

WEATHERFLEX

3" ASSEMBLY SPECIAL

3" X 25 FT \$99 COUPLED

3" X 33 FT \$125 COUPLED

CALL
TODAY!



POWER BOOSTER

**INCREASE VERTICAL LIFT
SAVE TIME ON DIFFICULT JOBS**

**SAVE \$50
THIS MONTH ONLY!**



INFO@CAPITALRUBBERCORP.COM

(800) 258-3000

WWW.CAPITALRUBBERCORP.COM

OFF THE SHELF

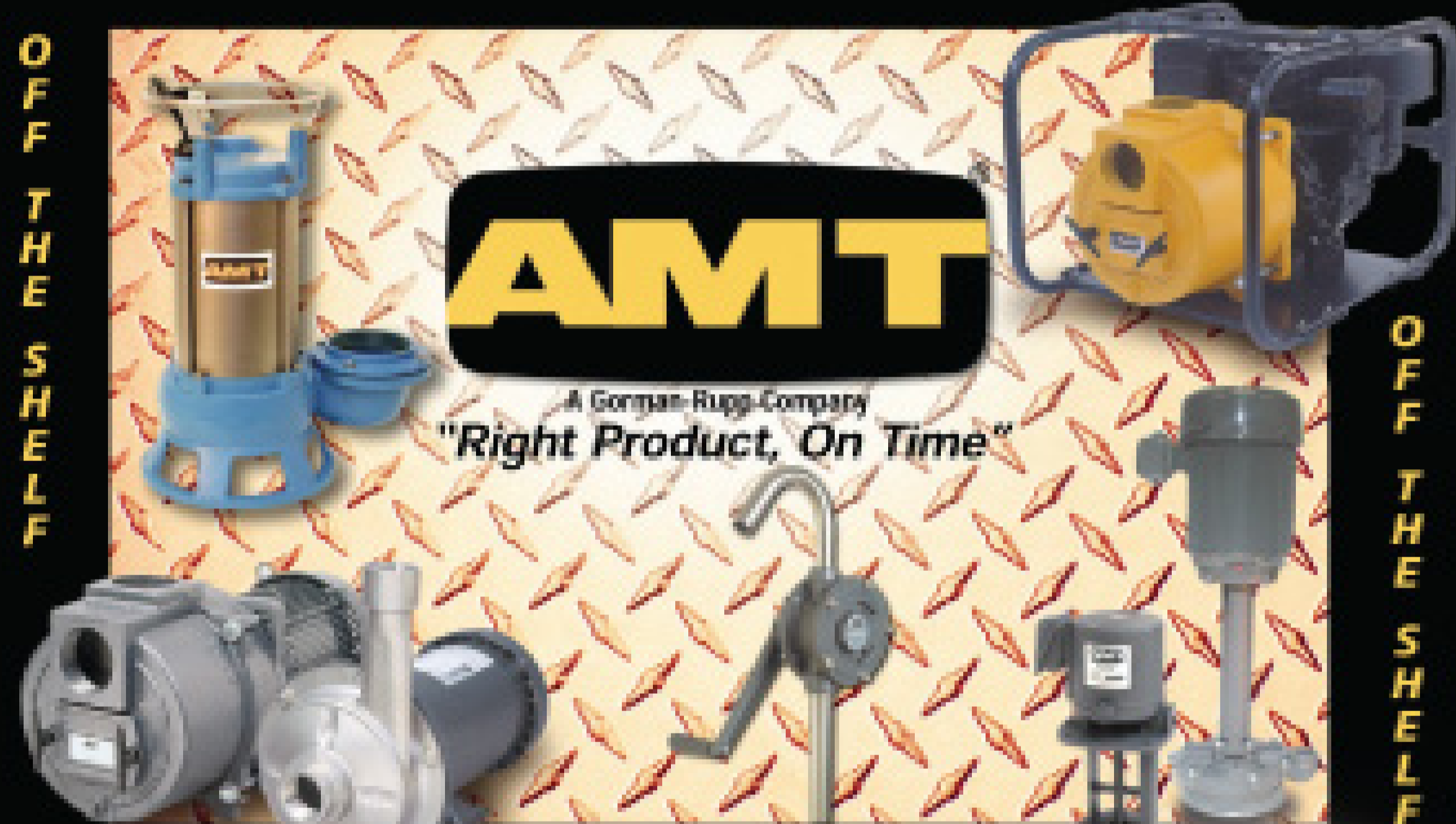

OFF THE SHELF

12 VOLT DC HIGH HEAD WASHDOWN PUMP

1 HP Washdown Duty Motor for Severe Operating Conditions

Investment Cast 316 Stainless Steel, Cast Iron or Cast Bronze Construction with High Efficiency Stainless Steel Impeller on all Models

Discharge Port Rotates in 90° Increments

Four Front Drain Plugs

Max. Flow 56 GPM Max. Head 80 Ft (30 PSI) Max. Temperature 200°F

The AMT 12 Volt DC Washdown Pumps are designed for pumper, septic service, OEM, and marine applications requiring a DC motor. The motor has one hour duty rating and is furnished with a grade 303 stainless steel shaft. Pull-from-rear design for ease of servicing without disturbing piping.

American Machine and Tool Co. Inc. of Pennsylvania
400 Spring Street
Royersford, PA 19468

Call us toll free at 888-268-7867 or visit our website www.amtpump.com



**Custom
Solutions**

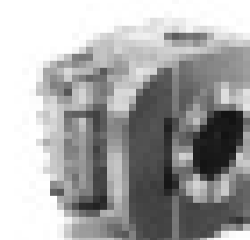

ROBOSCHI



**Let us Quote
your needs!**

20 Martins Ln. Elmira,
Ontario, Canada N3B 2A1

Visit us on the web
www.vacutrux.com

vacutrux

phone (800)-305-4305, (519) 669-1625
fax (519) 669-8331 sales: info@vacutrux.com

ABERNETHY

WELDING & REPAIR INC.

Vale, North Carolina 28168

Call Bill Abernethy at **1.800.545.0324**

Fax: 828.324.2401 • E-mail: abernethyinc@charterinternet.com

authorized distributor for:



Wittig

Masport

www.abernethywelding.com



2008 Chevrolet, C7500 with 8100 gas engine, 5 Spd. trans, 2 Spd. rear, air brakes, AC air ride driver seat, 33000 lb GVW. New 2500 gal. tank, HXL15 Masport air cooled pump, air shift PTO, many other standard features. **\$64,500**



2008 International 4400E Series, 260 hp diesel DT 466 engine, 6-spd. trans. and world class auto, air brakes, 33,000 GVW, air conditioned, 2500 gal. tank, Masport HXL400 pump. **IMMEDIATE DELIVERY!** Also, 2500 and 3500 gal. tanks **READY FOR IMMEDIATE DELIVERY.**



2008 International 4300, 220 hp DT466, Allison auto. trans., air brakes, 25,999 GVW, air conditioned, total tank capacity: 1100 waste/400 fresh, Masport HXL75V pump. **IMMEDIATE DELIVERY!** Also, 1500 gal. tanks **READY FOR IMMEDIATE DELIVERY.**

Check with us on financing for the purchase of a new truck!

• **International • Ford • GM**

2008 PETERBILT

2500 gal. tank, 10-spd., 330 hp

2008 KENWORTH T300

2500 gal. tank, auto transmission, 260 hp

(2) 2008 INTERNATIONAL 4400

2500 gal. tank, (1) 6-spd. transmission & (1) auto transmission

NEW PORTABLE TOILET UNITS:

2008 HINO

1500 gal. portable toilet service units, auto transmission

(2) 2008 INTERNATIONAL 4300s

1500 gal. portable toilet service units, auto transmission

2008 5500 CHEVROLET

1000 gal. 700 waste / 300 fresh, 2 Wheel Drive & 4 Wheel Drive available

2008 KENWORTH

1500 gal. portable toilet service unit, auto transmission

2008 PETERBILT

1500 gal. portable toilet service unit, auto transmission

WE WILL CUSTOM BUILD YOUR TANK UP TO 5000 GALLONS!

600-1500 Gallon Portable Toilet Trucks: Our Truck or Yours

SEVERAL GOOD, OLDER TRUCKS TO CHOOSE FROM:

- 2001 International 2000 gal. tank, good condition
- 1999 International 2500 gal. dump tank
- 1998 Volvo - 4000 gal. tank
- 1997 Volvo - 4000 gal. tank
- 1995 Chevrolet 2500 gal. dump tank
- 1995 International 2500 gal. tank
- 1991 Chevrolet 2000 gal. tank, low miles, low hours

PORTABLE TOILET UNITS:

- 2004 7550 Chevrolet 1000 gal. tank
- 2004 International 4300 Series 1100/400 gal. tank
- 2002 International NEW 1500 gal. tank, 1100/400 tank
- 2002 International 1500 gal. aluminum tank
- 1999 Sterling - 1500 gal.
- 1997 Ford F450 - 800 gal. tank
- 1994 UD - 1200 gal. tank

MANY OTHER UNITS IN STOCK! CALL FOR UPDATE

Complete Line of Masport Pumps Available



Immediate Delivery

COMPLETE PARTS AND IN-HOUSE SERVICE FOR:

AIC Vanes • Moro • Battioni • Jurop • Masport • Fruitland • NVE • Powerflo • Plus many other brands

OVERNIGHT DELIVERY ON PARTS • SAME DAY SHIPMENT ON PUMPS

WE SPECIALIZE IN PORTABLE SANITATION AND SEPTIC PUMPING EQUIPMENT

By **Scottie Dayton**

NATION **Report Identifies Successful RME Characteristics**

The Water Environment Research Foundation funded research that identified business characteristics common among 15 successful Responsible Management Entities. The 72-page report, *Business Attributes of Successful Responsible Management Entities*, provides guidance to businesses and organizations interested in becoming RMEs.

Certification through recognized training courses topped the authors' list of commonalities. Successful RMEs are certified in operation, maintenance, and inspection. They limit the type of systems they operate to three or fewer to simplify construction, operation, and maintenance, minimizing inventories on spare parts and training requirements.

Successful RMEs have a long-term financial plan, a strategy for growth, enough money to be self-sufficient, a sustainable monthly charge, and an independent financial advisor. Most RMEs grow their way to financial viability. The sustainable monthly fee must cover all costs, yet one common mistake was equating cost with only operation and maintenance. Long-term management also includes sampling and testing, replacing failed mechanical equipment, and more.

The report confirms that RMEs can't operate unless the public accepts the need for long-term maintenance and is willing to pay for it. Visit www.ndwrcdp.org/publications/index.htm.

MARYLAND **Behind the Times**

An article in the summer newsletter of the Maryland Onsite Wastewater Professional Association identifies the state's 25-year-old septic regulations as the largest impediment preventing use of advanced onsite technology.

The second greatest issue is industry workers with inadequate training. According to the article, any plumber, contractor, or backhoe operator can obtain an installer permit without demonstrating competency or providing training documentation.

The association is pursuing a state-mandated educational program. It proposes three certification categories: Designer, Installer, and Operator/Maintenance/Service Provider. Training would be required in conventional gravity systems, advanced pretreatment systems, sand mounds and pressurized systems, and drip systems.

MICHIGAN **CSE Photocopies to DEQ**

According to the Michigan Septic Tank Association, the state Department of Environmental Quality is asking haulers to submit photocopies of all earned Continuing Septage Education credits since the 2005 Waste Water Conference.

The agency will post the credits online for review, as each hauler's 30-credit-hour requirement for license renewal will be based on this information. If the DEQ doesn't receive the credits by the hauler's renewal date, that person may face an interruption in business while the situation is reviewed.

The renewal date for most haulers is Jan. 1, 2010. The DEQ must receive the CSE credits by Dec. 31, 2009. For new haulers, the renewal

date is five years from the date on the septage hauler license. Credits earned above the 30-hour requirement do not carry over. Haulers need 30 credits per five-year renewal period. Members can retrieve credits earned from attending MSTA-hosted classes at www.msta.biz.

WASHINGTON **Radio Program Links Onsite Pros, Consumers**

Operation and maintenance programs and a State of Washington mandate to inspect gravity systems every three years and pump them annually prompted numerous homeowners to call the Washington On-Site Sewage Association. "They are looking for information on how this will affect them and asking for names of service providers," says WOSSA president Jeannie Yackley.

The volume of calls led the organization to develop a 60-minute radio talk show expected to reach 250,000 listeners in Washington. *Septic Solutions* discusses the care, maintenance, and installation of onsite systems, urban myths and legislative issues. WOSSA assembled advertising and program partnerships to help underwrite the \$40,000 it costs to broadcast the program for 26 weeks. Call Jeannie Yackley at 253/770-6594 for more information.

To combat fuel costs, WOSSA is bringing more fall and winter training classes to its members, instead of having them travel to the training center in Puyallup.

The summer WOSSA newsletter reported that several members have had fuel stolen. One company had more than 200 gallons siphoned from a truck. When thieves found locking gas caps on vehicles at another company, they returned with a small tanker, cut the fuel lines on three trucks, and siphoned nearly 1,000 gallons.

Training & Education

Flooded Onsite Systems

The University of Minnesota Water Resources Center published the Fact Sheet, *What to do with your private onsite wastewater treatment system after a flood*. Installers may share it with customers. It's a free download at <http://commerce.wi.gov/SBdocs/SB-PowtsFlood.pdf>.

Sewage Biosolids

The Ontario Biosolids Utilization Committee posted *Sewage Biosolids: A Valuable Nutrient Source*, which explains how recycling the waste benefits farmers and society. The 8-page paper concludes with a list of Web sites to other biosolids agencies and sources for more information on using biosolids as a crop fertilizer. Go to www.omafra.gov.on.ca/english/nm/nasm.html.

Septic Systems and Source Water Protection

The summer issue of *Pipeline*, from the National Environmental Services Center, tells homeowners how to care for their onsite systems and protect their community's water quality. The document is a free download at www.nesc.wvu.edu.

Soils Course

The Wisconsin Department of Commerce Safety and Buildings is offering a course on Describing Soil Profiles and Recording Site Data on Oct. 10 at Northeast Wisconsin Technical College in Marinette. Call Jean Joyce at 608/267-7113.

WJTA Offers Vacuum Safety Seminar

The WaterJet Technology Association will present "Safe Operation of Industrial Vacuum Equipment" on Oct. 16 at the Clarion Hotel in Atlantic City, N.J. The seminar will teach contractors how to get the most out of their industrial vacuum equipment by maximizing safety and enhancing production. The seminar combines classroom training, a step-by-step overview of vacuum trucks and components using wet, dry and combo machines on site, and "ask the experts" round-table sessions.

Vactor/Guzzler's Phil Stein will review industrial vacuum loaders. Topics will range from operation to potential problems and safety issues. Gary Toothe, training manager for Thompson Industrial Services LLC, will cover job setup, maximizing production on the job-site, problems with mixing materials and case studies. Ravel Ammerman, a lecturer at the Colorado School of Mines, will discuss electrical hazards. For more information, call 314/241-1445; e-mail wjta@wjta.org, or visit www.wjta.org.

NAWT Training

The National Association of Wastewater Transporters has scheduled these sessions:

- Oct. 14 – Inspector Recertification Training, Holiday Inn, Casa Grande, Ariz. Contact Kitt Farrell-Poe at 928/782-3836; kittfp@ag.arizona.edu.
- Oct. 23-24 – Inspector Training and Certification, Fresno, Calif. Call 707/579-4882.
- Nov. 12-13 – Operation and Maintenance Part 2, Mill Valley, Calif. Call 707/579-4882.
- Dec. 9 – Vacuum Truck Training, Riviera Hotel, Las Vegas, Nev. Call NAWT at 800/236-6298 or visit www.nawt.org.

Alabama

Licensing classes are the joint effort of the Alabama Onsite Wastewater Association and University of West Alabama. Courses are at UWA's Livingston campus unless stated otherwise:

- Oct. 16-17 – Pumpers
- Oct. 29-30 – Continuing Education, Mobile
- Nov. 12-14 – Basic Installer
- Dec. 4-5 – Continuing Education
- Dec. 10-12 – Advanced Installer Level 2

Call Allen Tartt 205/652-3803 or visit www.aowatc.uwa.edu.

California

Certification courses are sponsored by the California Onsite Wastewater Association and NAWT.

- Oct. 8 – Soils, Central Calif.
 - Oct. 23-24 – Inspector Training and Certification, Fresno
 - Nov. 12-13 – Operation and Maintenance Part 2, Mill Valley
- Call Cliff Trammel at 707/579-4882.

Iowa

The Iowa Onsite Wastewater Training Center at Ankeny has these courses:

- Oct. 16 – Media Filters with Installation Demo
- Nov. 20 – Program Management with Rules

Call Annette Adams at 800/362-2127, ext. 6464 or e-mail Dennis Hayworth at dahayworth@dmacc.edu.

Michigan

The Michigan Onsite Wastewater Training and Education Center at MSU Tollgate Center in Novi is offering these courses:

- Oct. 8-9 – Existing Systems Evaluator Training
- Oct. 29-30 – Soils

Contact Barb DeLong at 517/355-4720 or visit www.egr.msu.edu/age, then Extension & Outreach.

Minnesota

The University of Minnesota Extension has these hands-on workshops:

- Oct. 21-24 – Service Provider Precertification, Mankato
- Nov. 18-19 – Installer Continuing Education, St. Cloud
- Nov. 19 – Pipelayer Certification, St. Cloud
- Dec. 2-3 – General Continuing Education, Brainerd
- Dec. 12 – Troubleshooting, Owatonna
- Dec. 17-18 – General Continuing Education, Mankato

Call Nick Haig at 800/322-8642 (612/625-9797) or visit <http://septic.umn.edu>.

Missouri

The Department of Health and Senior Services is offering these CEU courses:

- Oct. 7-8 – Troubleshooting and Hydraulics, West Plains
 - Oct. 21-22 – Lagoons and Drainfields/Curtain Drains, Camdenton
 - Oct. 28-29 – Lagoons and Drainfields/Curtain Drains, Moberly
 - Nov. 4-5 – Troubleshooting and Hydraulics, Joplin
 - Nov. 17-18 – Drip and Pumps/Panels/Electrical, Liberty
 - Dec. 2-3 – Lagoons and Drainfields/Curtain Drains, Springfield
 - Dec. 9-10 – Operation and Maintenance, Warrenton
 - Dec. 16-17 – Lagoons and Drainfields/Curtain Drains, Ironton
- Call Terri at 417/739-4100 or visit www.mosmallflows.org.

Nebraska

The Cooperative Extension at the University of Nebraska is offering these certified courses for CEUs:

- Oct. 15 – Extension Pumps and Controls, Norfolk
- Oct. 16 – Extension Dosed Systems, Norfolk
- Nov. 19 – Extensions Pumps and Controls, Grand Island
- Nov. 20 – Extension Dosed Systems, Grand Island
- Dec. 10 – Extension Pumps and Controls, Mead

Call the Nebraska Onsite Waste Water Association at 402/476-0162 or the university at 402/472-9614.

North Carolina

North Carolina Soils and On-Site Wastewater Training Academy is offering these courses at Raleigh unless stated otherwise:

- Oct. 8 – Onsite System Layouts, Pittsboro
- Oct. 9 – Principles of Gravity System Design, Pittsboro
- Oct. 15 – Inspector Field Practicum, Jacksonville
- Oct. 15 – Soil Structure, Asheboro
- Oct. 15 – Installing Pump Systems, Greensboro
- Oct. 16 – Installing Advanced Systems, Greensboro
- Oct. 16 – Inspector Field Practicum, Greenville
- Oct. 16 – Matching the System to the Site, Asheboro
- Oct. 17 – Soils of the Triassic Basin, Pittsboro
- Oct. 22 – Applications for Drip Irrigation Technology, Mills River
- Oct. 23 – Drip System O & M, Mills River
- Oct. 24 – Soils of the Lower Mountains, Mills River
- Oct. 29 – Soils of the Upper Mountains, Laurel Springs
- Oct. 30 – Matching the System to the Site, Laurel Springs
- Nov. 5-7 – Subsurface Wastewater Operator, Plymouth

- Nov. 12 – Soil Texture, Monroe
- Nov. 12 – Onsite System Layouts, Boone
- Nov. 13 – Pump System Design, Boone
- Nov. 13 – Redoximorphic Features, Soil Wetness and Water Table Relationships, Monroe
- Nov. 14 – Pumps and Controls, Monroe
- Nov. 18-19 – Onsite Wastewater System Inspector, Plymouth
- Nov. 20 – Inspector Field Practicum, Plymouth
- Dec. 1 – Flow Equalization and Timed Dosing
- Dec. 2 – Pump System Design
- Dec. 2 – Low Pressure Pipe System Design
- Dec. 9-10 – Drip Dispersal Design for N.C. Proprietary Systems
- Dec. 11 – Large Drip Dispersal System Designs
- Dec. 12 – Soils of the Outer Banks, Manteo
- Dec. 17 – Remote Systems, Greensboro
- Dec. 18 – Basic System Troubleshooting, Greensboro

Call Joni Tanner at 919/513-1678 or visit www.soil.ncsu.edu/training.

Rhode Island

The University of Rhode Island's Onsite Wastewater Training Center offers these professional development workshops at its Kingston campus:

- Oct. 16 – Innovative and Alternative Systems Field Tour
- Nov. 6 – Designer Examination Prep
- Nov. 20 – AutoCALCS – Automated BSF Sizing, Pump Calculations and Support Materials
- Dec. 4 – Regulatory Setbacks and Buffers
- Dec. 18 – Nitrogen Dynamics in the Environment and Onsite Wastewater Systems

Call Holly Meehan at 401/874-5950 or Mark Stolt, when directed, at 401/874-2915 or visit www.uri.edu/ce/wq.

Virginia

The following courses by the Virginia Center for Onsite Wastewater Training and Southside Virginia Community College are in Blackstone unless stated otherwise.

- Oct. 12-15 – A to Z of Onsite Wastewater, Blacksburg, (VOWRA)
- Oct. 12-15 – Soils, Blacksburg, (VOWRA)
- Oct. 14-15 – Construction Inspection
- Oct. 23-24 – Understanding Water Movement in Soils
- Oct. 28-29 – Construction Inspection
- Nov. 19-20 – Effluent Dispersal Systems
- Dec. 10-11 – Wastewater 101

For VCOWT classes, contact Debbie Campbell at 434/736-2011 or visit www.southside.edu/classes_wastetreat.asp. For VOWRA courses, contact Trapper Davis at 804/966-9190 or visit www.vowra.org. ■

Oct. 12-15

Virginia Onsite Wastewater Recycling Association Conference and Trade Show, Blacksburg. Call Trapper Davis at 804/966-9190 or visit www.vowra.org.

Oct. 14-15

Delaware Onsite Wastewater Recycling Association Conference and Exhibition, Dover Downs Hotel and Conference Center, Dover. Call Ken Walsh at 302/381-6516 or visit www.dowra.org.

Oct. 23-26

Ontario Association of Sewage Industry Services Conference and Exposition, Best Western Conference Centre, Orillia. Call Don Kelloway at 877/202-0082 or visit www.oasisontario.on.ca.

Nov. 5-9

Portable Sanitation Association International Convention & Trade Show, Hilton Hotel Ocean Beach and Ocean Center Exhibit Hall, Daytona Beach, Fla. Call 800/822-3020 or visit www.psal.org.

Nov. 11-12

Trenchless Road Show, Turf Valley Resort, Baltimore, Md. Call Michelle Magyar at 330/467-7588 or visit www.trenchlessroadshow.com.

Nov. 12-13

North East Residuals & Biosolids Conference & Exhibit, Nashua, N.H. Call Ned Beecher at 603/323-7654 or visit www.newea.org.

Dec. 4-5

Kentucky Onsite Wastewater Association Conference, Sloan Convention Center, Bowling Green. Call 270/715-0043 or visit www.kentuckyonsite.org.

Dec. 8-9

NOWRA Installer Academy, Riviera Hotel, Las Vegas, Nev. Call 800/966-2942 or visit www.nowra.org.

Jan. 8-10, 2009

Michigan Onsite Wastewater Recycling Association Conference and Exhibit, Kellogg Hotel and Conference Center, East Lansing. Call Chanin Frank at 989/773-6985, ext. 258 or visit www.mowra.org.

Jan. 13-14

Iowa Onsite Waste Water Association Conference, Polk County Convention Complex, Des Moines. Call 515/225-1051 or visit www.iowwa.com.

Jan. 13-15

Ohio Onsite Wastewater Association Conference and Trade Show, Ramada Plaza Hotel and Conference Center, Columbus. Call 866/843-4429 or visit www.ohionsite.org.

Jan. 19-21

Missouri Smallflows Organization Conference and Exhibition, Holiday Inn Select, Columbia. Call 417/739-4100 or visit www.mosmallflows.org.

Jan. 22-24

Alberta Onsite Wastewater Management Association Conference, Deerfoot Inn and Casino, Calgary. Call 780/489-7471 or visit www.aowma.com.

Jan. 23-24

Washington Onsite Sewage Association Conference, Vancouver. Call John Thomas at 253/297-2837 or visit www.wossa.org.

Jan. 26-28

North Carolina Septic Tank Association Conference and Exposition, Hickory Metro Convention Center, Hickory. Call Doug Lassiter at 336/345-8357 or visit www.ncsta.net.

Jan. 30-31

Wisconsin Liquid Waste Carriers Association and Wisconsin Onsite Water Recycling Association Joint Convention, Marriott West Hotel, Madison. Call 608/255-2770 or visit www.wowra.com.

Feb. 11-12

Nebraska Onsite Waste Water Association Conference. Call Lee Orton at 402/476-0162 or visit www.nowwa.org.

Feb. 14-15

Utah On-Site Wastewater Association Conference, Expo Center, West Valley City. Call Carmell Burns at 435/797-3174 or visit <http://uwri.usu.edu/partnerships/training/uowa.html>.

Feb. 25-28

Pumper & Cleaner Environmental Expo International, Kentucky Exposition Center, Louisville, Ky. Call 800/257-7222 or visit www.pumpershow.com.

SERVICE RECORDS * SERVICE CALL FORMS

CUSTOM SIZES * SPECIAL COLORS *

*** WAF LABELS & DECALS RECORDS**

We Specialize in Waste Management Labeling Solutions

• Service Records	• Logo Signs
• Lock out Tags	• Gender Signs
• NRC Records	• Service Call Forms
• Warning Decals	

All Printing & Signs Can be Customized at No Additional Charge

 **Anchor Graphics**
Labels & More

Tel: 972-422-4300 • 1-800-875-7659
Fax: 972-422-4311 • www.anchorgraphics.com

*** WARNING DECALS * CUSTOM DIE CUTS * SERVICE RECORDS**



3800 Gallon Front Hoist Full Rear Opening Door

2 compartment, 5.6 GPM jetter package
Robuschi Blower RB-DV45, 4" rear inlet, 6" dump valve.

2008 Kenworth T300

54,000 G.V.W.

10 speed transmission...loaded.

\$133,790 Plus FET

Monthly Lease From...\$1911



7000 Gallon Trailer

5454 Aluminum- 3/8" heads, Full length hose trays, (2) ladders, rear bumper, 6" discharge - 4" inlet, Hendrickson air ride.

\$56,500 Plus FET F.O.B., Arthur, IL

Monthly Lease From...\$975 *

World's Largest **ARTHUR TANK progress tank** Distributor

800-971-7657

Visit www.tstllc.com / email us from our website



3600 Gallon 'Roll-Off' Septic

Masport HWL400WV, Stellar 40,000# Hook Lift

2008 Freightliner

Cummins ISC 300 HP Diesel Engine
9-speed, 16,000# Front Axle /40,000# Rear Axle

\$136,000 Plus FET

Monthly Lease From...\$2,346*



2000 Gallon Restroom Tank

Masport HXL4, Burks washdown, Hot shift PTO

2009 Peterbilt 330 26,000 GVW

Cummins, auto trans, air brakes

\$88,255

Monthly Lease From...\$1,522



Additional Lease Option Available

BUY IT NOW! \$99 mo.

Until March 2009, thereafter regular payments for 60 months with no residual buyout at the end.

Ask us for details.

'Guaranteed Credit Approval'

100s of Vacuum Tank Trucks Assembled

Most Tank Sizes & Chassis **IN STOCK!**

Delivery Service Available



**RENT ME
LIKE ME
BUY ME**

**KMH EQUIPMENT
COMPANY**

**SALES
RENTAL
SERVICE**

154 Bender Road, Marietta, OH. 45750

888-KMH-0202

888-564-0202

Your outsource resource for Industrial air movers,
hydro-excavators, combination vacuum jetters, liquid
DOT trucks, parts and accessories

8405 EAST 30 TH. STREET, Indianapolis, IN. 46226

317-897-4KMH

317-897-4564



2006 Volvo VHD 64F, AquaTech B-12 Combination sewer Cleaner, Hydro-Excavation Package with Boiler, 20,000 Miles, 1700 Engine Hr., 220 Blower Hr., TS56 Hibon Blower, 310 Water pump hr., 65gpm @ 2500 psi



New 2007 Volvo VHD 64F, VacAll 1215 Combination Sewer Cleaner, Available with Hydro-Excavation package, Hibon TS56 Blower 18 Hg, MSS 55 Water pump 80 gpm @ 2000 psi



New 2007 Volvo VHD 64F, VacAll 1215 Combination Sewer Cleaner, Available with Hydro-Excavation package, Hibon TS56 Blower 18 Hg, MSS 55 Water pump 80 gpm @ 2000 psi



2005 International 7600, Vac-con 4716SMXD Hydro-Excavator, 16 cy Debris tank, 3000 psi @ 15 gpm cat 3560 73,370 miles, 2560 engine hr. 1175 blower hr. 1021 DVJ



2000 Sterling LT9513, Clean Earth wet- Dry Dresser Roots 1021 DVJ Blower, 16 cy Debris 181506 Miles, 1610 Blower hr.



2004 Sterling LT7501, Vac-Con V312LHAE Combo. FMC-Bear Water pump 80 gpm @ 2000 psi, 16 cy, 13330 miles, 2230 Engine hr., 555 Auxillary eng. Hr.



New 2008 Hino 338, VacAll / Clean Earth E10 Sweeper, All new except 2004 Cummins 6BT Auxillary engine with 583 hours.



2004 Sterling LT7500, AquaTech B-10, Lateral hose reel, Cat C-7 engine, 3034 hours, 64456 miles, 1000 gal. water, 80 GPM @ 2000 PSI, Roots 824 Blower, 15" Hg 3300 CFM



Coming soon; new 2008 Sterling Acterra, Presvac DOT 407/412 dump type vacuum unit with choice of PV750 vacuum pump or VTB 820 blower.

Michigan Vacuum Trucks

**Custom Built Tanks
to Your Specs!**

P.O. Box 234 Carleton, MI 48117

Custom Built Vacuum Trucks to Meet Your Business Needs

**All trucks are equipped with Masport Pumps
1/4" Steel Construction**

Totaled Your Truck?

Rent a Vacuum Unit
while your truck gets fixed

2500 gallon vacuum body
ready to install on cab and
chassis **\$18,000.**

Specializing in
New Vacuum Trucks,
Used Vacuum Trucks,
Toilet Trailers & Slide in Units.

Purchase a New Portable Toilet
Truck for only \$45,000*

In Progress: **2003 Freightliner FL70**
with a new 2500 gallon vacuum body
400 CFM vacuum pump. **\$41,000**

Call Terry at Michigan Vacuum Trucks
734-777-0390

We Can Also Mount a Custom Designed
Vacuum Tank on Your Chassis!

Call for a FREE quote today!

734.777.0390

*Prices are subject to change.



**Masport
NVE**



Our **VALUE** goes deeper than you realize.

When it comes to portable sanitation solutions, WALEX delivers much more than blue deodorizers and accessories. We're giving you **innovative research & development** that has set all the current standards for excellence. You're getting **proprietary breakthroughs** that our competitors can only emulate. When you choose WALEX, you're not only getting **the best on the market today** — *you're also supporting your industry's future.*



For more information, contact us at **910.371.2242**, toll-free **800.338.3155**
or visit our website at **www.walex.com**.



KNOW-HOW TO GET YOU MOVING

Now In **STOCK!** On-The-Lot Selection *Call For Prices & Pre-Approval!*



2007 Sterling 4200 aluminum tank, NVE 506 pump, PTO jetter 10 GPM, 3500 PSI 150 gallon water tanks 66000 GVW, 410 HP, 10 spd.

Call for price



2007 Sterling 2500 gallon Steel Jurop pump, Mercedes 260 HP, 10 spd, engine brake, traction control ALUMINUM HOSE TRAYS.

\$79,000



2003 Sterling with new 2500 gallon tank, 210 HP manual trans, Jurop pump.

Call for price and details.



New Tandems are coming in soon

Call for details

FREE DELIVERY

Anywhere in the lower 48 in July.

We Have Financing Available!

Call Us Today Toll-Free:

888-201-9166

www.badgertruck.com

Septic - Portable Toilet - Hoisted Vacuum - Slide-Ins
New! Units Available / Trade-ins Accepted! / Financing & Lease Plans



LEASING SOLUTIONS



If you have special or unique needs, for straight answers and a quick response, call Jim Thomas.

Conserve your working capital. Keep existing credit lines intact, and enjoy the security of knowing financing is there when you need it. We offer loan and leasing plans tailored to individual needs.

- Portable Toilets
- Pumper Trucks
- Water Jettors
- Vacuum Trucks
- Sewer Equipment
- TV Inspection
- New and Used Equipment

- Programs offer longer terms for older equipment.
- We do start ups.
- 90 Day Delayed Billing.
- Seasonal Payment Programs Available

Get Pre-Approved for the Pumper & Cleaner Environmental Expo

Prompt, no nonsense financing designed to meet individual requirements. Payment plans that are generally lower than other finance plans. With years of experience, we understand the competitive nature of your business.

We're prepared to act quickly and decisively!

Toll-Free 877-333-4539 • www.keycommercial.com



TRUCK TOWN

2601 East Hwy. 80 • Abilene, Texas 79601

FULL SERVICE VACUUM SYSTEMS SUPPLIER



1-800-727-0350

GOOD ASSORTMENT OF CUSTOM SPEC TRUCKS FOR YOUR VACUUM UNIT NEEDS

LELY SEPTIC & OIL FIELD VACUUM TRUCKS
 TROXELL TRAILERS



JEFF MULLICAN • HUBERT YOUNG • DENNIS ADAMS

Phone: 325-673-4642 • Fax: 325-673-4673
 Web Site: www.truck-town.com • E-mail: truck@camalott.com

Buy it on DVD!

He's number one with your number two.

KENNY

"KENNY is the funniest film I've seen this year"

—Oscar-winning filmmaker Michael Moore

★★★★★

—Herald Sun

"With a touch of romance, *Kenny* is a great Aussie comedy that WILL LEAVE AUDIENCES IN STITCHES."

—Northern Territory News

"SO FUNNY that bowel-loosening could be a very real danger."

—Stella Papamichael, BBC

"INCREDIBLY LIKEABLE and FUNNY."

—Andy Klein, Los Angeles City Beat

"HILARIOUS!"

—Sydney Morning Herald

**The BIG SPLASH
from DOWN UNDER!**

A JACOBSON BROTHERS FILM

XENON PICTURES, INC., LIGHTNING ENTERTAINMENT and THUNDERBOX FILMS in association with SPLASHDOWN present "KENNY" a JACOBSON BROTHERS FILM starring SHANE JACOBSON EVE VON BIBRA RONALD JACOBSON IAN DRYDEN CHRIS DAVIS JESSE JACOBSON produced by CLAYTON JACOBSON and ROHAN TIMLOCK with RICHARD PLEASANCE and SHIRLEY CRAIG CARTER

THUNDERBOX FILMS

www.lightning-ent.com

www.xenonpictures.com/kenny

© 2008 Motion Cinema. All Rights Reserved - Distributed by Xenon Pictures, Inc.

PG-13 PARENTS STRONGLY CAUTIONED
SOME MATERIAL MAY BE INAPPROPRIATE FOR CHILDREN UNDER 13
FOR CRUDE CONTENT, LANGUAGE AND PARTIAL NUDEITY
For more information go to www.filmratings.com

DOLBY DIGITAL XENON

www.xenonpictures.com

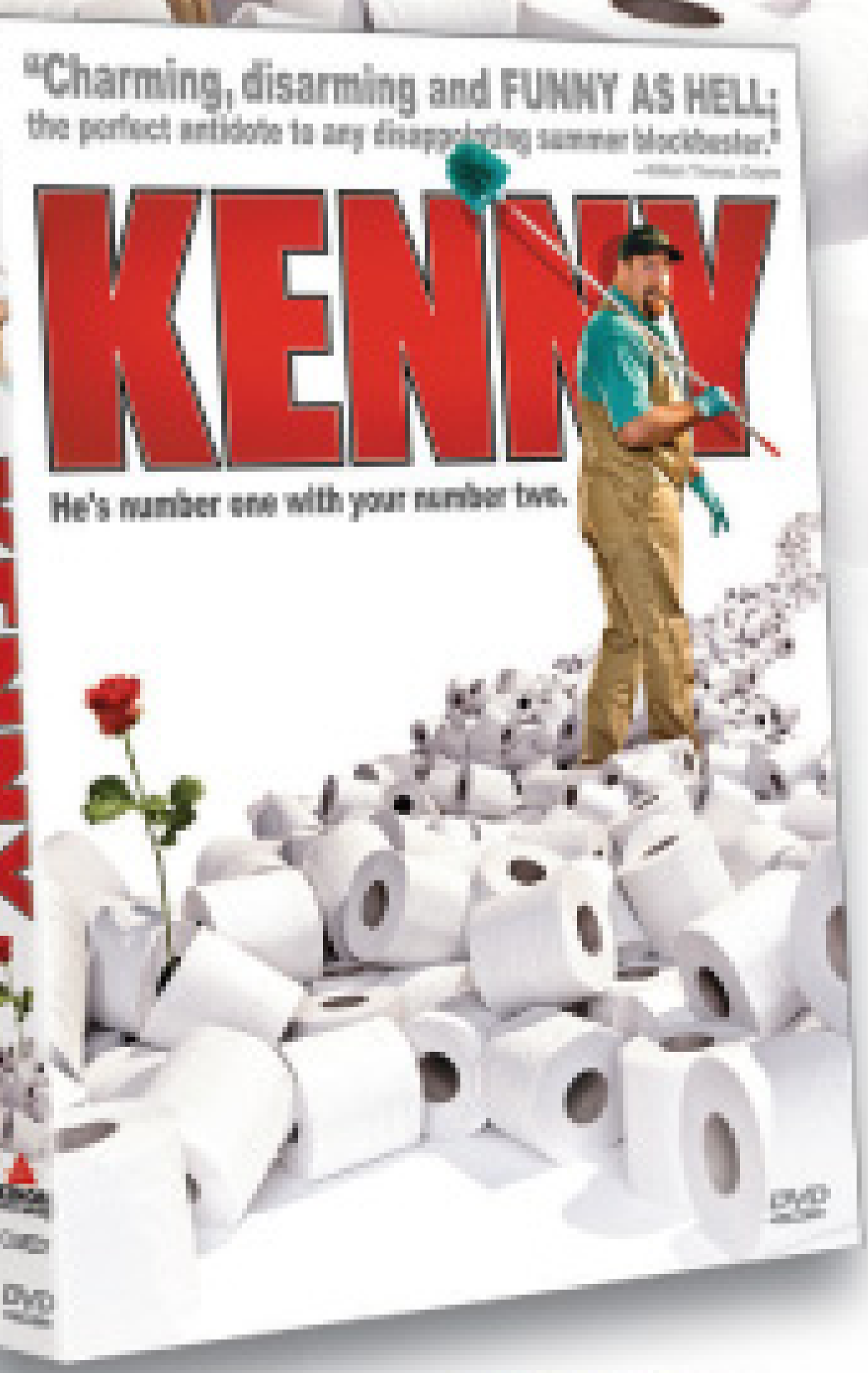

Available at



www.BestBuy.com™

Experience Matters.

Custom vacuum tanks built to your specifications.

For nearly 50 years, our tank builders have been setting the industry standard for innovation and value. Everything we build is customized to your exact specifications. Start with a bare tank and add only the options that are suitable for your application. What about service? Our technicians can rebuild pumps or furnish parts such as vanes, seal kits, housings, and rotors for most pumps. Whatever you need, let us put our experience to work for you.



Bare tank w/no attachments

Bare Tank:

Prices are for the tank only with no openings, hatches, rails or other attachments. LMT can furnish items for you to attach to your tank at additional cost. Please call for more information and pricing.



Basic tank w/optional manway and hose trays

Basic Tank:

Prices include primary shutoff, full length rails (straight or tapered), 4" discharge nipple, and 3" intake nipple.

Check out some of the options:

- ✓ Manways (20", 25", 36")
 - ✓ Full open door (2 types)
 - ✓ Primary & secondary shutoffs
 - ✓ Valves for loading & unloading
 - ✓ Oil catch mufflers
 - ✓ Suction hose & couplings
 - ✓ Mounting rails & kits
 - ✓ Vacuum pumps (Jurop, Masport, Moro, Fruitland, and others)
 - ✓ Hose trays and hangers
- And more...

LMT Basic & Bare Tank Prices:

(subject to change without notice)

	Basic Tank	Bare Tank
1500 gallon: 54" dia. x 12' long w/1 baffle.....	\$ 5,150.....	\$ 3,765
2000 gallon: 60" dia. x 14' long w/2 baffles.....	6,200.....	4,850
2500 gallon: 66" dia. x 14' long w/2 baffles.....	7,100.....	5,700
3000 gallon: 68" dia. x 14' long w/2 baffles.....	8,000.....	6,570
3500 gallon: 72" dia. x 17' long w/2 baffles.....	9,550.....	8,030
4000 gallon: 78" dia. x 16' long w/2 baffles.....	10,685.....	9,125
4200 gallon: 78" dia. x 17' long w/2 baffles.....	11,170.....	9,580

Custom sizes up to 6000 gallon are available.

All lengths are can length excluding flanged and dished ends. All tanks over 70" dia. have 2 braces of 2" x 3" solid steel to prevent collapse of tank. All tanks are cleaned with an acid solution and prime painted. We can also customize the paint color for an extra fee. Tanks are manufactured with mild steel and are welded with submerged arc process for the best strength and appearance. Stainless steel is available at extra cost.



Call us at 800-545-0174 before you buy!

LMT Inc. - Custom Vacuum Tanks

Tel: 309.932.3311 • Fax: 309.932.3155 • info@tanksandpumps.com
www.tanksandpumps.com



THANKS, REED PUMPING



STAINLESS STEEL & STEEL UNITS - CALL FOR INFORMATION



THANKS, ENGLAND TRUCKING

PUMP DISTRIBUTOR

- * BATTIONI
- * JUROP
- * BOWIE
- * MASPORT
- * FRUITLAND
- * MORO

Pump Rebuild Kits In Stock

CALL TODAY FOR INFORMATION OR PRICES ON TANKS, PUMPS AND ALL PARTS

Secondary Shutoffs



12" Primary Shutoffs



Sight Glasses, Valves & Couplings



21" & 36" Manways



CUSTOM SKID UNITS



800.364.7307

2100 EAST BOOTH ST. • SEARCY, AR 72143
Fax: 501.279.0003 • E-mail: sbs@cdlworld.net



VAC-CON

PRE-OWNED EQUIPMENT

MORE POWER TO YOU



2000 VAC-CON VPD3609SHA

- 2001 IH 2654
- 275 HP / Allison MD3060
- 60 @ 2000 / Cummins 110 HP
- Mileage: 33,000

RECONDITIONED **\$145,000**



1997 VAC-CON V312THAE/1300

- 1997 Ford LNT8000
- 275HP / MD3060
- 50 @ 3000 Water Pump
- Mileage: 66,703

RECONDITIONED **\$135,000**



2004 VAC-CON V390LHAD

- 2004 International 7400
- IH 275 HP / Allison MD3060
- 50 @ 3000 / DEUTZ 138 HP
- Mileage: 11,000

RECONDITIONED **\$198,500**



1998 VAC-CON VPD3612LHA

- 1999 IH 2554
- 275 HP / Allison MD3060
- 80 GPM @ 2000 PSI
- Mileage: 116,000

\$130,000



2000 VAC-CON V312LHA

- 2001 IH 2554
- IH 275 HP / Allison MD3060
- 50 @ 3000 / Cummins 110 HP
- Mileage: 122,800

RECONDITIONED **\$135,000**



2001 VAC-CON VPD3609

- 2002 IH 2654
- 275 HP / Allison MD3060
- 60 @ 2000 / Cummins 110 HP
- Mileage: 33,000

RECONDITIONED **\$165,000**



2001 VAC-CON V312LHAD/1300

- 2001 Sterling LT9501
- CAT 380 HP / 10-Speed
- 80 @ 2000 / Cummins 110 HP
- Mileage: 73,000

RECONDITIONED **\$185,000**



1995 VAC-CON VPD3690THA

- 1995 FORD LN8000
- Cummins 250 HP / Allison MD3060
- 30 @ 3000 / John Deere 4039T
- Mileage: 57,500

RECONDITIONED **\$95,000**



www.vac-con.com



Ultimate Lease Hotline:
888-817.1757

969 Hall Park Drive • Green Cove Springs, FL 32043 U.S.A.
Tel: 904-284-4200 • Fax: 904-284-3305
www.vac-con.com • vns@vac-con.com

Lenzyme Designs Maintenance Brochure

Lenzyme has designed a homeowner education brochure on the importance of regular cleaning and maintenance of septic and plumbing systems. The brochure includes information on how systems work through bacterial action and a calendar reminding homeowners to maintain their systems. For more information: **Homeowner education brochure from Lenzyme**
800/223-3083.

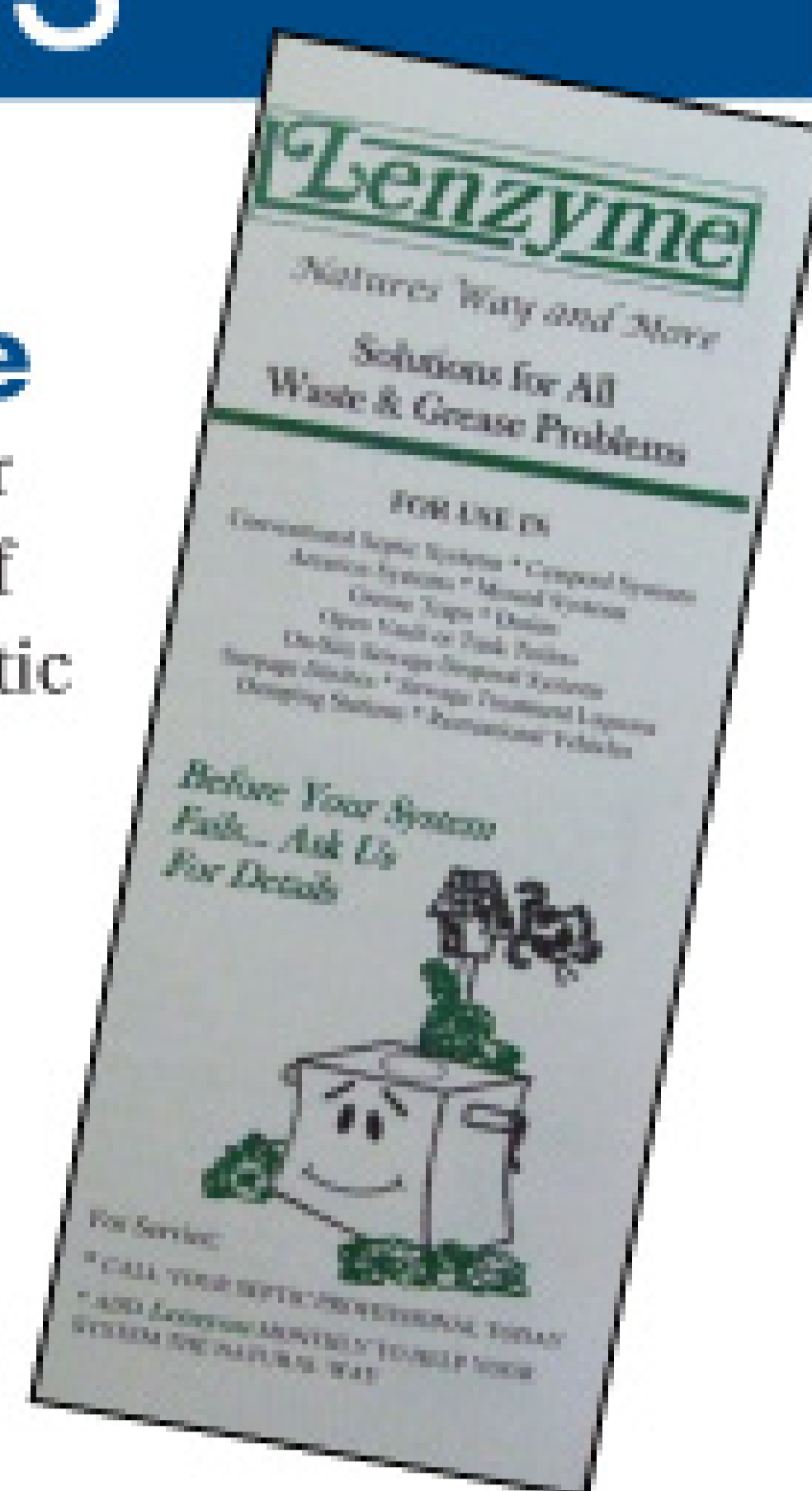

Capital Rubber Raises \$1,500 for Troops

Capital Rubber Corp. of Wood Dale, Ill., raised \$1,500 for Operation Support Our Troops of Illinois through a June and July promotion that set aside a portion of proceeds from each order. The funds will be used for care packages for troops overseas and to aid wounded soldiers returning home and their families.

Hannay Releases Pressure Wash, Spray Hose Reel Catalog

Hannay Reels' latest catalog features its line of pressure wash and spray hose reels for steam cleaning, washdown, general maintenance and spray options. Also included are compact reels for smaller, mobile steam cleaning and pressure wash units, as well as portable garden hose reels for grounds maintenance. For more information: 877/467-3357; <http://go.hannay.com/IND>.

Simple Solutions Adds Distributors

Simple Solutions LLC, makers of the Wolverine brand of activated carbon filters, has added new distributors Carleton Environmental Services, Richmond, Ontario; Missouri Water and Wastewater Products, Camdenton, Mo.; and YTG, Yemen Technical Group, Sana'a, Haddah, Yemen. ■

Hull's Truck Bodies

459 Joe Shoemaker Rd. | Minford, OH 45653

Vacuum Trucks built to order, any size or make, delivery to all 50 states. Quick turn around time.



Phone: 877.898.5104
E-mail: hullstruckbodies@yahoo.com
Webpage: hullstruckbodies.com

Coagulants and Flocculants
for Septic, Grease, Municipalities and Industry

Save Money

Save Time

Save Polymer

- Dewatering polymers for all dewatering equipment
- All forms: Dry and Emulsion
- Variety of packaging sizes to meet customer needs

- Both East & West coast shipping points
- Expert technical staff
- Specific solutions for our customers

Call Toll-free: 877.771.6041

Aqua Ben Corporation
1390 N. Manzanita St. • Orange, CA 92867
www.aquaben.com • sales@aquaben.com

toll free:
(866) 457-5425

EXPLORER

Toilet transporters

POSI-STRAP

POSI-CLAMP

Secure Transportation for portable toilets with wooden or plastic skids!

Distribution Centers

California	Colorado	Texas	Florida	Alberta
Plumas Sanition Tel: (530) 832-0370 Fax: (530) 832-0373 Partola CA	Columbia Sanitary Tel: (303) 526-5370 Fax: (303) 526-9686 Golden CO	Woyl Enterprises Tel: (903) 586-6493 Fax: (903) 541-0874 Jacksonville TX	Steve Baie Enterprises Tel: (407) 709-8175 Fax: (407) 822-3566 Apopka FL	Ted Hoover Tel: (403) 946-4108 Crossfield AB

Manufactured by:
McKEE TECHNOLOGIES INC.
ELMIRA, ONTARIO, CANADA N3B 2Z7

visit us on the web
www.explorertailers.com



Manufacturing

- *Stainless Steel*
- *Aluminum*
- *Code & Non-Code*

800-589-5254

ACRO

Trailer Company

*Vacuum Trailers for the
Liquid Transportation Industry*
Parts • Repair • Complete Pumping Systems

www.acrotrailer.com • 417.862.1758 • fax 417.862.8084 • 2320 North Packer Road • Springfield, Missouri 65803

CLEAR COMPUTING *with* INSIGHT

Total Activity Control Street Eagle GPS

Reduce Operating Expenses

More profitable in any economy!
Call today!

- NEW Calendar Dispatch Board
- In-Vehicle Garmin Updates
- Free Credit Card Software
- TACTrackerPRO
- Lease or Buy

1988 – 2008

20

YEARS OF
EXCELLENCE



Try it Yourself Free...
On the Web or Your PC.

Clear Computing
(888) 332-5327
www.clearcomputing.com

Insight USA
(301) 866-1990 x201
www.mds-inc.com



**4000 Gallon
pumper on a 2007
M2 Freightliner**
Tank: Bright finish
aluminum-5/16" #5454
shell and heads 76" Dia.

Pumping system: Jurop LC420 water cooled pump
Chassis: Freightliner M2-54,000 GVW, C-7 Caterpillar 300 H.P., 10
speed transmission-14,600 front axle-40,000 air ride rear axle.

**2800 Gallon
pumper on a
2007 International**

Tank: Bright finish
aluminum-5/16"
#5454 shell
and heads

Pumping system: Masport HXL 15
(350 CFM)

Chassis: International 4300-33,000 GVW, 245 HP DT466-RDS
3500-12,000 front axle, 21,000 rear axle.



WHITE RIVER
DISTRIBUTORS, INC.
BATESVILLE, ARKANSAS

(800)-548-7219
(870)-793-2374
www.lpgbobtails.com

Quality People Doing Quality Work

Vacuum Septic Units



Thank you, Jack Millikin, Inc. for purchasing this 2500 gal. septic service unit.

DOT Industrial Vacuum Units



Portable Restroom Service Units



IN STOCK - 650/300 gal. Call for Details Ready for Immediate Delivery - Priced at \$56,147

Mini Vac Trailers



DOT Code & Non Code

Slide-In Units



IN STOCK - Slide-In Portable Restroom Units - Call for Details Industrial Skid-Mounted Units Also Available

Marsh INDUSTRIAL

P.O. Box 1107 - 135 E Mile Road - Kalkaska, MI 49646
p: 231.258.4870 - f: 231.258.2019 - sales@marshind.com

800.952.1537 - WWW.MARSHIND.COM

**Centrisys Corporation
Septage Dewatering Systems**

- Unhappy with your dewatering box or rotary vacuum filter dewatering systems?
- Interested in opening new revenue sources for contract sludge dewatering?
 - Interested in saving a large amount of money in hauling costs?

Solution: Centrisys Corporation

Centrisys offers turn-key centrifuge septage dewatering systems. These systems will produce a solids phase similar to the consistency of potting soil (35-50% dry) as opposed to what is offered by a dewatering box and the Centrisys system does not use expensive filtering media as found in rotary vacuum dewatering systems.



For more info call: 209-304-2200 or 262-654-6006

www.centrifuge-systems.com

**Seal it Tight!
Seal it Easy!
Seal it Fast!**



- Easy 10 minute installation!
- Secure fit for all systems!
- Made & sold by septic installers!
- Prevent ground water infiltration and save money at the same time!



Apply foam inside to tank.



Place ring over opening and apply foam.



Place plastic riser pipe on ring.



Install lid.

Are you tired of using risers that are too tall or too short for the job you are completing? Plastic riser pipe will give an exact height each time. Try our system and you will never have to carry concrete pipe and lids again. Save time by not having to assemble multiple sections.

Seal-R® Lids Available in 12", 15", 18", 24", 30", 36".
Seal-R® Rings Available in 18", 24", 30".
Inner Safety Lids Available in 18", 24".

Seal-R® Lids can be personalized! Seal-R® Lids are constructed with UV additive to resist degradation from exposure to sunlight.

For more information, call us today!

BrenLin Company, Inc
Manufacturers of Seal-R® Products
Hornsea, MN
888-606-1998

Fax 320-677-3001 • Email: brenlin@brenlin.com

www.seal-r.com

Wow Your Clients... with Absolute Luxury!

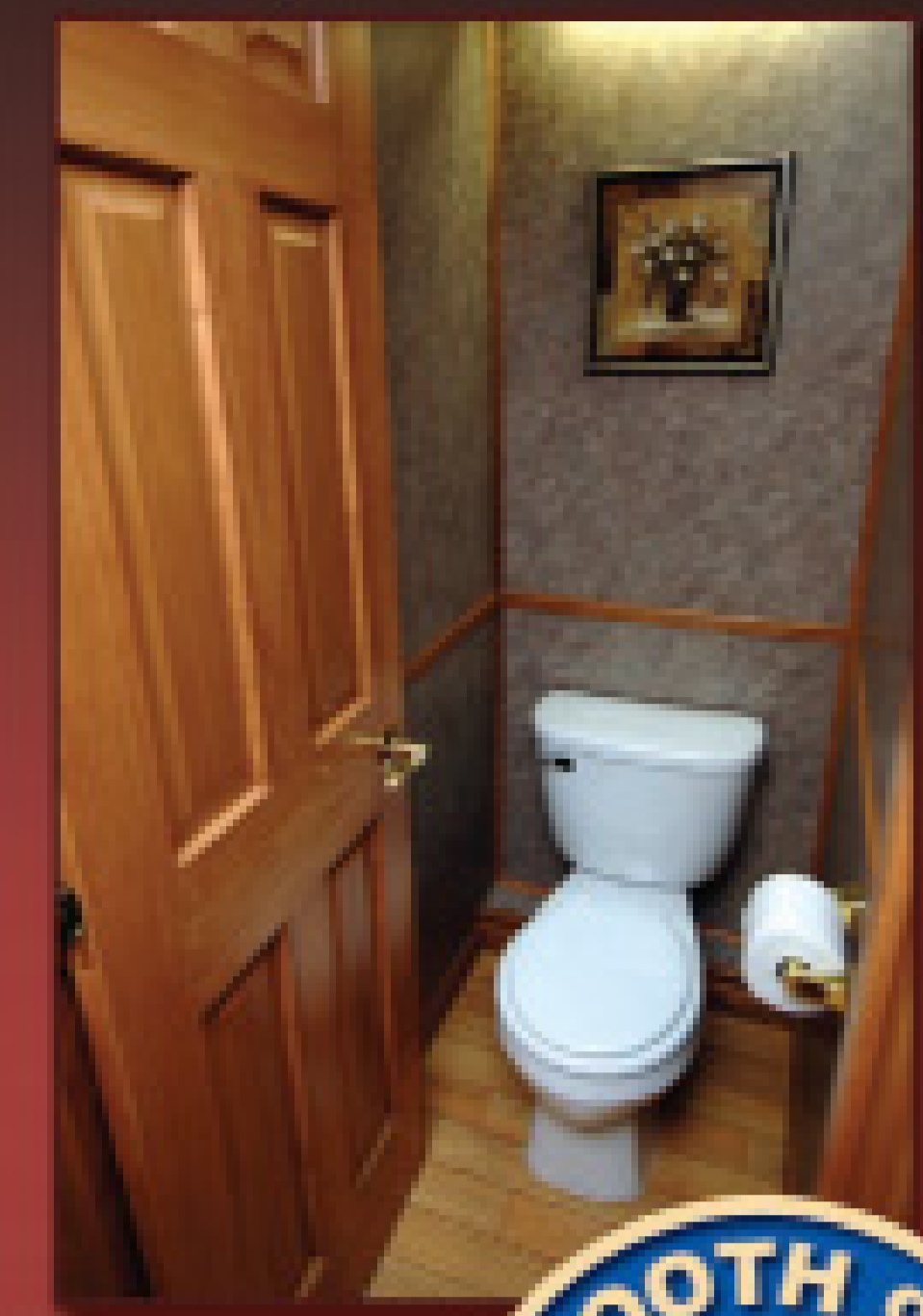

Elegant

MOBILE RESTROOM SUITES



© 2006 BLACK TIE MANUFACTURING, INC.



FROM BLACK TIE MANUFACTURING

877-253-3533

WWW.BLACKTIEMANUFACTURING.COM

CUSTOMIZE YOUR TRAILER
OR CHOOSE FROM OUR MANY STANDARD FLOOR PLANS!

ALBERS / CADMAN Emergency or Temporary Liquid Storage

- Safe, affordable enclosed storage.
- Up to 1.3 million gallons.
- Various agitator options.
- Neighbor friendly odor control.
- Blends in with surroundings.
- Fully transportable systems also available.



Your containment solution is only a phone call away.

Cadman
www.cadmanpower.com

38 Main St., Courtland Ont., Canada
1-866-422-3626 (519) 688-2222
Fax: (519) 688-2100



435 GALLON VACUUM TANK



- 1/4" Aluminum Construction
 - Conde Super 6 Pressure Vac Pump with 5.5 hp Honda Electric Start
 - 12 Volt Water Pump
 - 300 Waste/135 Fresh
 - 25' Hose and Wand
 - 2" Sight Eyes in Waste
 - Sight Tube on Fresh Water
 - Completely Self-Contained
 - Ready to Work
- *OTHER SIZES AVAILABLE***

Robinson Septic Service Inc.

125 Rockrimmon Dr., Bellefonte, PA 16823 • t: 814.353.0263 • email: honeydippers@aol.com
1.800.252.3848 • www.robinsonseptic.com



VSI Vacuum Sales Inc.

51 Stone Rd. | Lindenwold, NJ 08021

888-VAC-UNIT | 888-822-8648 | Fax: 856-627-3044
E-mail: vsisales@aol.com | www.VacuumSalesInc.com

NEW EQUIPMENT CUSTOM BUILT TO YOUR SPECIFICATIONS



(1499V) 1997 Peterbilt 378 with a Cusco Master Vac 3800 Machine 3,200 U.S. gallons DOT Certified, wet/dry industrial, vacuum tank loader.



(8734V) 1998 International 4700 with a 1,500 U.S. gallon, 2 - compartment (1100 / 400 split), Carbon Steel; portable toilet service unit.



(13337 A, B, C & D) 2009 Peterbilt 340 with a Presvac 3,600 gallons (US), aluminum vacuum tank unit. In Production!!



(13325V) NEW Presvac 5,500 gallon C/S, DOT Certified, Vacuum tank unit, self contained. In Stock.



(7948V) 2001 Mack RD6885 cab and chassis Pre-owned Coleman 3,200 U.S. gallon, Stainless Steel, vacuum-pressure tank with a NVE 466, Air cooled, vacuum-pressure pump



(13297E) 2008 Peterbilt 340 with a Presvac 3,600 gallons (US), aluminum vacuum tank unit.



(4675C) 2000 Kenworth T300 cab and chassis with a Presvac 2,010 U.S. gallons; D.O.T. certified Vacuum Tank.



(13335 A, B, C & F) 2009 Peterbilt 340 with a Presvac 3,200 gallon, c/s DOT certified 407/412 Dump type vacuum tanker with a full open rear In Production!!



(13336) 2009 Sterling LT9500 triaxle with a new Presvac, Powervac 3800, 3,250 gallon (US), DOT, wet/dry industrial, vacuum tank loader



(13317V) New PipeHunter Model 38T44 Jetting unit Trailer mounted unit, w/ 335 Poly water tank 4,000 psi @ 25 gpm, 600 ft of hose and attachments.



WEST-MARK

1-800-692-5844
ASK FOR JEFF HURST

www.west-mark.com

jhurst@west-mark.com

IN STOCK DISASTER RELIEF TRUCKS

POTABLE WATER COMBINATION TRUCKS!

3,800 GALLON STAINLESS STEEL TANK
NEW 7400 INTERNATIONAL
300 HP DIESEL, AUTOMATIC TRANSMISSION
350 GPM @ 150 PSI BRONZE WATER PUMP
DETAILED SPECIFICATIONS AVAILABLE UPON REQUEST
TWO (2) IN STOCK



PORTABLE RESTROOM TRUCKS

2000 GALLON (500-1500) ALUMINUM TANK
KENWORTH T-270, 26,000 GVW
AUTOMATIC TRANSMISSION, AIR BRAKES
PACCAR PX-6 DIESEL ENGINE
MASPORT HXL4 VACUUM PUMP, DUAL SERVICE
BURKS DC10 WATER PUMP DUAL HOSE REELS
TWO (2) IN STOCK
FINANCE AND LEASE OPTIONS AVAILABLE



Tanks For Your Business

Mid-State Tank manufactures stainless steel and aluminum tanks and has become a well-known and respected supplier for the agricultural, aviation, industrial and fire services, as well as pressure/vacuum tanks.

Mid-State Tank holds an ASME stamp and is D.O.T. approved.



Mid-State Tank Co., Inc.

PO Box 317 • Sullivan, IL 61951
(800) 722-8384 • Fax: (217) 728-8384
www.midstatetank.com



NEED SOFTWARE?



The Leading QuickBooks® add-on Software for today's Portable Sanitation Business.

- Interface with QuickBooks® - The Service Program generates your recurring route billing and seamlessly allows you to print the invoices in QuickBooks®
- Easily Manage Routes
- Competitive Upgrades Available - Receive a Discount to Convert Off Your Existing System
- Palm and Windows PDA Handheld Support w/Remote Sync
- Track Pick-Ups & Drop-Offs
- Works with Mapquest® and Mappoint®
- Track Inventory at Multiple Locations
- 30-Day Money Back Guarantee-Leasing Available
- 30 Day No Risk FREE Trial with Weekly Training

866.480.1879
www.theserviceprogram.com

FIND LEAKS and SOURCES of ODOR

Quick • Inexpensive • Easy
with the

Superior® 5E Electric Smoker



Using Superior® Classic Smoke Candles, or Superior® SP Smoke Pellets

www.SuperiorSignal.com • Superior Signal Company • 800-945-TEST



Serving the Industry for Over 40 Years!

One-Stop-Solutions For PORTABLE SANITATION & SEPTIC & GREASE HAULERS

BUYING DIRECT ALWAYS EQUALS COST SAVINGS

Big Shot® Con2 & Con2 Plus

- Super Strength Concentrate
- Non-Formaldehyde
- Ideal for Summer Use

ENHANCED FRAGRANCE!

STRONGER DYE

NEW FEATURES ON 3 GREAT PRODUCTS!

NEW FORMULA!

Ultra PowrPak XL

Convenient Carry Pail
Effervescence

SEPTIC TANK ADDITIVES \$6 (Per Pkg)

LONG LASTING PINK CUBE \$160 (Per 4x5 lbs.)

Designed to last in hard to service liftstations/grease traps

NEW PACKAGING OPTION

SEWER FOAM \$59.75 (Per Pail)

Reduce solids and hydrogen sulfide odors - Economical approach to sewer maintenance.

**BUY DIRECT CALL CHEMPACE
1-800-423-5350**



DENVER TRUCK SALES

Nobody Beats Our Quality!



2000 IHC 9400 & 9900

14,000 LB f/a, 3406E Cat 435-475 hp, Jake, 15-18 speed transmission, 46,000 LB rears Hendrickson air suspension. New 3360 gallon tank HXL-400 pump serviced and checked.

From \$62,950 plus F.E.T. on the tank



2001 Peterbilt 379

14,600 lbs. FA, C-15, 475 Cat, Jake, RTLO-18918 Transmission, RT-46160 on Pete air tract, 46,000 lbs. 4-way locks, New 3360 Gallon Tank, HXL 400 pump.

From \$79,950 Plus options and FET on the tank



1996-2001 Western Stars

435-475 hp Cat, Jake, 18 speeds 46,000 LB rears on Hendrickson air suspension. New 3360 gallon tank, HXL-400 Masport pump, serviced and checked.

From \$64,950 plus F.E.T. on the tank

Easy Financing and Lease-To-Own WAC!

Complete Line of Pumps and Parts



2001-2003 KW T-800 Series

C15 Cat 475 hp, Jake, RTLO-16918 transmission, RT46160 46,000 LB 4.33 ratio, new 3360 gallon tank, Masport HXL-400 pump, new paint serviced and checked.

From \$79,950 plus F.E.T. on the tank

Denver Truck Sales • 5293 Vasquez Blvd. • Denver, CO 80216
Phone: 303-291-0960 • Fax: 303-291-0244 • www.denvertruck.com

FINANCING

FOR ALL YOUR NEW & USED EQUIPMENT

GIVE US A CALL TODAY! 866-769-2345

31 YEARS OF EXPERIENCE WORKING FOR YOU!



- Application Only to \$250,000.00
- Simple Approval Process
- Lease or Loan Options
- Aggressive on Used Equipment
- Start-up Programs
- Flexible Financing Available

CAPITAL PARTNERS

101 N. Main Ave. Suite 215
Sioux Falls, SD 57104
www.yourcapitalpartner.com
866-769-2345

YOUR ONE STOP FINANCING PARTNER

Competitive Pricing, Simple Processing,
Honest Answers

Be Cool, But Nev-R-Freeze



Nev-R-Freeze, the Environmentally Friendly Toilet Anti-Freeze.

Safely Keeps Your Toilets Serviceable Even in the Coldest Environments

Can be used in hand washing stations in winter to keep from freezing.



250 Old Marlton Pike
Medford, New Jersey 08055
609-714-2424 Fax: 609-714-3030 www.delvel.com
Toll Free: 800-699-9903 E-mail: cgiusti@delvel.com
Call For Pricing

Visit us
at the
PSAI Show

All In!



When you receive *Pumper* each month there is no need to bluff.

Join 25,000 of your industry peers each month who welcome *Pumper*, for the unlimited value it brings them. Each issue will show you new tools, tips to save on expenses, money-saving deals and much more.

800.257.7222
www.pumper.com

Subscribe today
to guarantee
your winning
hand!



Sludge Mate
& Poly-Mate

The Flo Trend® Sludge Mate® and Poly-Mate® form an economical and simple to use sludge dewatering system. The Poly-Mate® conditions sludge through the addition of polymer prior to the dewatering process which occurs in the Sludge Mate®. These units are designed to dewater sludge from a multitude of waste stream sources including: water and wastewater treatment plants, septic tanks, car washes, industrial sumps and lagoons, grease traps, rendering plants, and food processing plants. The Sludge Mate® and Poly-Mate® are available in a variety of sizes and configurations, and are built to custom specifications.



DEWATERING MADE SIMPLE.

Flo Trend Systems Tel - 713-699-0152
 707 Lehman St. 800-762-9893
 Houston, TX 77018 Fax - 713-699-8054
 sales@fлотrend.com

2008 International 7400

56,000 GVW **Auto Transmission**
 3600 Gallon Masport HXL 400 water cooled, 400 CFM pump,
 Hot shift PTO, 20" top man way, 20" rear cleanout
 Rear sump with 6" discharge
 and 6" flange.
 Large tool box

\$114,200

Monthly Lease
 As Low As...
\$2,284

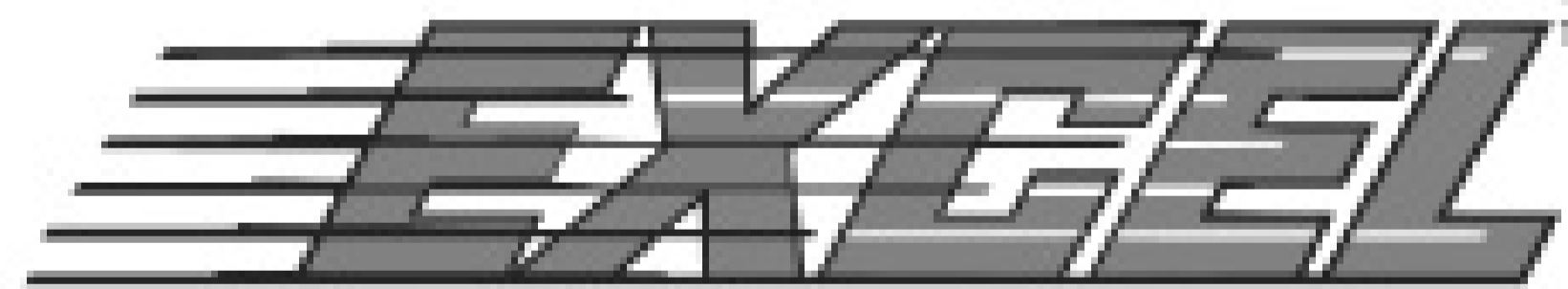

EQUIPMENT & SUPPLY CO INC.

1-800-392-3513

Tel: 317-882-1300
 Fax: 317-889-0052

2008 Sterling Bullet Restroom Service

Cummins diesel-305 HP, automatic trans.,
 7000 lb ft. /13,500 lb. Rr., Exhaust Brake.
 1250 Gallon Tank (2) compartment
 Masport HXL4, dual service,
 Burks DC 10 wash down,
 Tow package and toilet carrier.

\$70,300 from... **\$1406** mo.



www.excel-equipment.com

585 Sayre Court, Greenwood, IN 46143

ALPHA
 Mobile Solutions



Manufactured by
 Forest River



- Hot water heater
- A/C and heat strip
- 740 ga. waste tank
- 200 ga. fresh water tank



CALL FOR INFORMATION OR VISIT OUR WEBSITE

1-877-789-1213

www.alphamobilesolutions.com

IN STOCK!
Financing Available

1700 Gallon Restroom Tank

Masport HXL4, Burks washdown, Hot shift PTO
2008 Kenworth T300 22,000 GVW
 Auto transmission. & hydraulic brakes
\$77,555 Monthly Lease From...\$1,152



2000 Gallon Restroom Tank

Masport HXL4, Burks washdown, Hot shift PTO.

2009 Peterbilt 330
 26,000 GVW, Cummins, auto trans, air brakes

\$88,255
 Monthly Lease From...\$1,522



3800 Gallon (2) Compartment Septic Tank

Masport HXL400 water cooled Jetter system with reel

2008 International 4400
 Auto transmission
\$112,500 Plus F.E.T.
 Monthly Lease From...\$1,943



2008 Sterling Bullet Restroom Service

Cummins 305 HP, automatic trans., 7000 lb front /13,500 lb. Rear Exhaust Brake, AM/FM-CD.
1250 Gallon Tank
 Masport HXL4, dual service, Burks DC 10, toilet carrier.

\$69,900
 F.O.B. Kansas City
 Monthly From...\$1,205



800-264-8348 Voice
 573-547-8420 Fax
 573-450-5196 After Hours
www.semotank.com

Your Turn Key Solution To Trucks
"Ready to Go"

Contact:

Glenn "Mac" McCallister Donnie Moyers Jeff Kalp
 gmmccallister@semotank.com tdmoyers@semotank.com jnkalp@semotank.com

SEMO/BAKER ACRO

United to Broaden Your Tank Services
 456 Semo Lane, Perryville, MO 63775

Agitation SAVES Aggravation!

CHOICE OF
 2', 4' & 6'
 EXTENSIONS



Guaranteed To Mix Up Septic Tanks & Grease Traps!

High speed rotation busts the crust and removes solids right off the bottom of the tank into a total liquid form
Field tested and proven to mix a residential tank in 5 minutes or less - takes approx. 15minutes to agitate a 5000-10,000 gallon grease trap

CRUST BUSTERS

E-MAIL pete@crustbusters.com
 WEB SITE www.crustbusters.com

CHECK OUT OUR NEW INFORMATIONAL DVD
PUMPER.COM/VIDEO.PHP

Schmitz Brothers L.L.C.
 PHONE 763.878.2296
 FAX 763.878.2299

1.888.878.2296

ASK ABOUT OUR "BUSTER BRACKETS" FOR TRUCK MOUNTING

Custom Built YOUR Truck or Pull-type Chassis or OURS



- Septic Systems
- Municipal Waste Control
- Ag Operations
- Supplier for Brass or Stainless Steel Gate Valves
- Vacuum Pumps of All Sizes

Call Kevien Schroeder Today! 1-800-795-8551 ext. 124

Vertical Electric Pump

Agitate, transfer or top fill hauling units. Choose from standard lengths of 4' - 6' - 8' - 10' - 12', other sizes available upon request



Galvanized Construction!

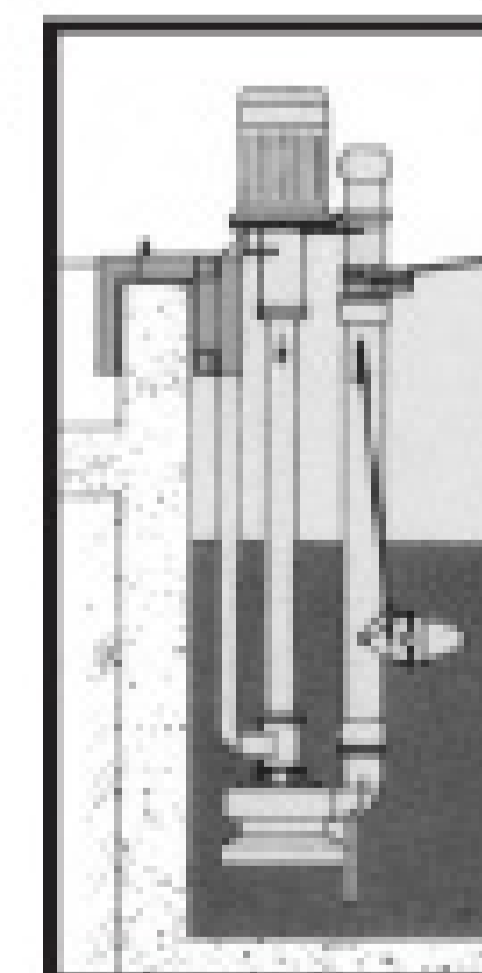

BALZER INC.

STEWARDS FOR **AG** ENVIRONMENTS

CO. RD. 27, Box 458
 Mountain Lake, MN 56159
 1-800-795-8551
www.balzerinc.com

Mid Continent Truck Sales, Inc.

891 Adkins Hill Rd. • Norman, OK 73072 • 405-329-5365 • Fax: 405-329-5381 • After Hours: 405-288-6502 • www.vacuumtrucksales.com

Trucks - Trailers - Vacuum Tanks - Pumps



2001 IH 4700, DT466E, Allison auto, non-CDL, air brakes, new MEC 6500 vacuum pump, new 1100/400 vacuum tank.



1992 IH 4900, DT466, 6-spd., 33K GVW, double frame, Wally 553HR vacuum pump, 2300 gallon vacuum tank.



1998 Freightliner FL60, Cummins 5.9 (210 hp), 6-spd., Masport H75V vacuum pump, General 47 series triplex, 1100/200 gallon vacuum tank.

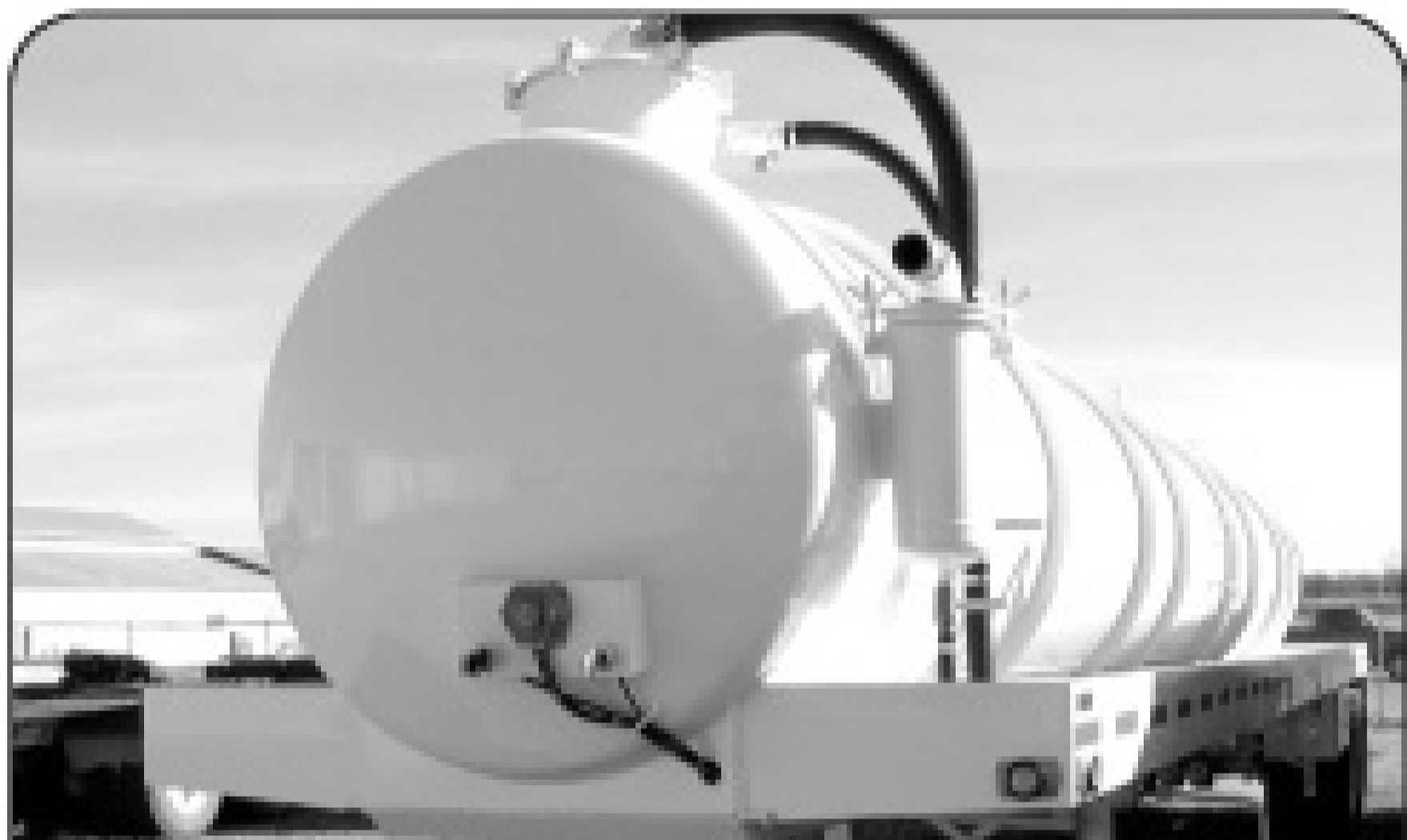

New Fluidmaster 5460 gal. vacuum trailer in stock. Also several used vacuum trailers in stock.



1999 IH 9900, Detroit 60 series (430/500 hp), 10-spd., new Wally 753LN vacuum pump, new 3000 gallon vacuum tank.



1989 Chevrolet C70, 8.2 ltr. diesel, 5+2 air brakes, double frame, MEC 5000 vacuum pump, 1500 gallon vacuum tank.

CALL US BEFORE YOU BUY!

MID CONTINENT TRUCK SALES

manufactures and stocks all necessary components to complete your vacuum system. Whether it's pumps, valves, moisture traps, oil catch mufflers, pump frames, etc.

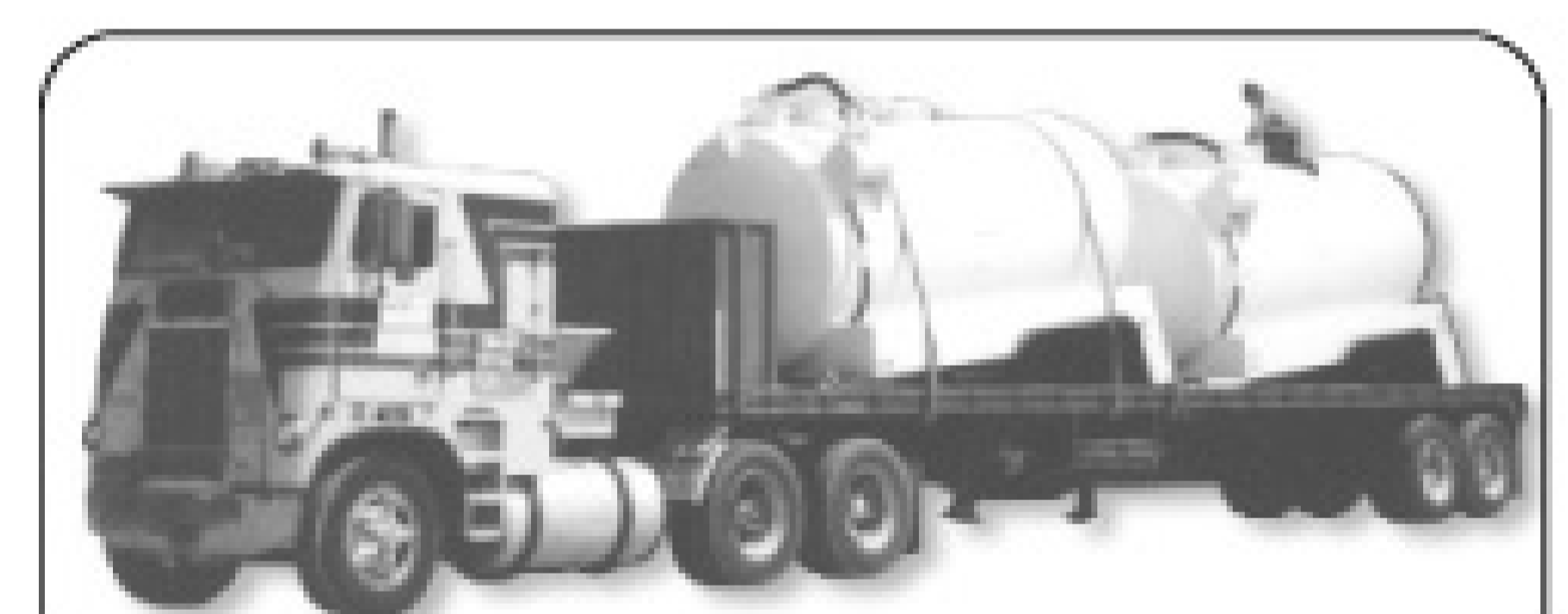

LET US QUOTE YOUR NEXT VACUUM TANK!

Kerr Pumps
Since 1946



Masport

NVE

AUTHORIZED DISTRIBUTOR



vallenstein
vacuum pumps

BOWIE



FLUID AND SLURRY
PUMPS

WE CARRY MOST BRANDS OF VACUUM PUMPS AND PARTS!



WE WILL BUILD TOILET UNITS TO YOUR SPECS!

Call DAVE PERRY for TRUCK quotations and CHUCK RODGERS for TANK quotations.

- ▶ Advertising
- ▶ Aerators
- ▶ Bucket Machines
- ▶ Businesses
- ▶ Business Opportunities
- ▶ Cable Machines
- ▶ Computer Software
- ▶ Dewatering
- ▶ Drainfield Restoration
- ▶ Drain / Sewer Cleaning Equipment
- ▶ Dredges
- ▶ Excavating Equipment
- ▶ Hazardous Waste Units
- ▶ Hydroexcavation
- ▶ Jetters-Trailer
- ▶ Jetters-Truck
- ▶ Jet Vacs
- ▶ Lease Financing
- ▶ Locators
- ▶ Miscellaneous
- ▶ Parts & Components
- ▶ Pipeline Rehabilitation
- ▶ Portable Restrooms
- ▶ Portable Restroom Sinks
- ▶ Portable Restroom Tanks
- ▶ Portable Restroom Trailers
- ▶ Portable Restroom Trucks
- ▶ Positions Available
- ▶ Positions Wanted
- ▶ Positive Displacement Blowers
- ▶ Pressure Washers
- ▶ Pumps-Dredge
- ▶ Pumps-High Pressure
- ▶ Pumps-Submersible
- ▶ Pumps-Vacuum
- ▶ Pumps-Water
- ▶ Rodding Machines
- ▶ Roll-Off Containers
- ▶ Roll-Off Trailers
- ▶ Roll-Off Trucks
- ▶ Root Control
- ▶ Safety Equipment
- ▶ Septic Tank Forms
- ▶ Septic Trucks
- ▶ Service / Repair
- ▶ Slide-In Unit
- ▶ Sludge Applicators
- ▶ Tanks
- ▶ Tools
- ▶ Trailers- Vacuum / Tanker
- ▶ TV Inspection
- ▶ Vacuum Loaders
- ▶ Vanes
- ▶ Vehicle Tracking
- ▶ Wanted
- ▶ Wastewater Transfer
- ▶ Waterblasting

ADVERTISING

SANITATION POSTCARDS & MAGNETS: Remind your customers and prospects with color postcards and magnets. Economical marketing tools. Call Toll Free 888-334-4553. Visit www.postcardprinting.com. (PBM)

BUSINESSES

PORTABLE TOILET BUSINESS located in Albany, NY. 600+ units, 3 service trucks, 2 P&D trucks. 20 years family built business. Excellent growth potential. Call Stanley @ 518-441-7222. (CPT11)

FOR SALE: Established 15 years, septic pumping business in Eastern Massachusetts. Excellent reputation, 3000+ client list includes residential and commercial customers. Solid income, excellent growth potential. In the midst of busy season now. Sale of business includes a 1995 Ford L-9000 vacuum truck with 330 hp Cummins engine, 3600 gallon tank, 4 years new. Serious inquiries only @ masepticco4sale@gmail.com. (CPT112)

PORTABLE TOILET BUSINESS FOR SALE. Located in Central Wisconsin. 377 portables, trailers, trucks, spare parts, contracts., etc. Turn key operation. Motivated seller! \$450,000. Call VR Business Brokers 715-833-1510. (P10)

FOR SALE in Fairbanks, Alaska: 50 year established septic pumping & thawing business. Federal and local contracts in place. Large customer base. Great cash flow. Purchase includes: 2 pump trucks, 1 steam truck and all related equipment for operations. \$350,000 OBO. 907-452-2743. It's not just a job, it's an adventure!!! (P10)

FOR SALE: 30-year established septic pumping & line cleaning business located in Central Minnesota. Large customer base includes residential, commercial & municipal. Includes 4 vacuum trucks, 2 service vans, line cleaning equipment, camera & jetting equipment, trailer with a Kubota backhoe. Also available is the shop, house & office on 6 acres. Serious inquiries only!! Call for more information. 763-441-4548. (P10)

BUSINESSES

This well established septic pumping co. has 60+ years of experience and more than 14,000 customers in the database serving the North West Suburb of Los Angeles and surrounding areas. The equipment includes five residential pumps, two transfer tanks, one commercial pumper and two pick-up trucks. In 2007 the company recorded gross sales of nearly \$950,000. There is a great opportunity to add installation, repair, inspection, locating, and maintenance services to increase profits. Equipment is valued at \$400,000+. Priced at only \$629,000. For more information please contact Jeff at 818-483-4777 x209. (P11)

Arizona pumping company with onsite treatment plant, established 1947. Owners cash flow for first six months of 2008 is \$97,414. Asking \$300,000. Call Scott, WCI Brokers 623-824-4355. (P12C01)

FOR SALE: Full service septic pumping, grease trap pumping and drain cleaning business on the western slope of Colorado. Business established in 1993 with large established loyal customer base and excellent reputation. Two 2000 gallon vacuum tank trucks (2005 Int. and 1989 Ford with hydraulic hoist), one 300 gallon vac-tank on 1-ton for small grease traps and 1 service truck complete with sewer cleaning and repair tools. All serious inquiries will be given proper consideration. Please contact us at 970-249-1816 or email terck@wildblue.net. (P10)

Liquid waste hauling and disposal business, 30 years in central Arkansas. Septic and grease trap service. Trucks, customers, and permits. Selling for health reasons. 1-800-603-3491. (P10)

Long Island, New York: For Sale: Cesspool, Septic, Sewer and Drain Cleaning Company For Sale. 2 pump trucks, 2 porta-pottie trucks (service and delivery). Quality workmanship, has established 3000+ loyal customer base. Great opportunity for right person. Jump in on busy season! Money maker! Debt free! Office/shop/yard also available. Call for more information. 631-472-0677. (PBM)

BUSINESSES

FOR SALE: Sunny South Florida. Full service septic tank business established 20 years. Great potential; great records. Owner retiring. Call Chris 305-297-2171. (P112)

FOR SALE: Established company in Florida specializing in the following services: onsite septic installation service & repair, septic pumping & cleaning, portable chemical toilet service. Turnkey operation! Equipment, trucks, accounts. Serious inquiries only. Call TLS 1-352-428-5939. (PBM)

FOR SALE: Septic pumping and portable toilet rental business. Located in Mid-northern Wisconsin. Established over 30 years. Includes 3 pumper trucks, 1 slide-in unit on Ford PU, over 100 portable toilets, various related equipment. Call 715-453-3037. (P10)

FOR SALE: 20-YEAR ESTABLISHED PORTABLE TOILET BUSINESS IN WV. ± 350 Tuff Johns, ± 50 Satellites, some fiberglass, 6-8 holding tanks (mobile office), 4 toilet hauling trailers: 2006 F550 w/100 gal. water, 250 gal. waste; 2005 F550 w/250 gal. water, 500 gal. waste; 1985 Mack pumper w/jetter, 2500 gal. waste, 1000 gal. water. 300-350 toilets on rental now. Gross \$350,000 yearly or more. Will not sell equipment without customer base. Serious calls only. 304-472-7962; ask for Tammy. (P10)

BUSINESSES WANTED: Septic pumping, grease trap, drain cleaning and other ancillary businesses wanted. We are buying well run businesses in New England, Mid-Atlantic and Florida. All opportunities will be given proper consideration. Confidentiality ensured. Will move quickly for the right opportunity. Serious inquiries only. Please contact Richard Bedard @ Blue Water, 617-326-3344 or rbedard@bwseptic.com. (CPBM)

FOR SALE: Well established septic pumping and portable toilet business located in Challis, Idaho. 160 toilets, 12 handwashers, 5 trucks, trailers, spare parts, good cash flow, average gross \$200,000, one man operation and still have time to fish & hunt! Call 208-879-2800. (P12)

BUSINESSES

FOR SALE: Septic and Portable Toilet Business located in White Mountains, Arizona. 150 toilets, 2 ADAs, 3 trucks. For more info, respond to: 11448 East Monte Ave., Mesa, AZ 85209. (PBM)

PROFITABLE Plumbing, Drain Cleaning, Septic Pumping. Well-established business! No debt! **\$229,000.** www.raysislandplumbing.net. (P10C11)

Septic service + portable toilet rental company on British Columbia's Sunshine Coast. Stable business with growth potential. Operated from 3.75 acres of prime property including residence available as a separate purchase. Contact Brent at 604-626-7414 or brent@sequoiabusinessbrokers.com. (P11)

BUSINESS OPPORTUNITIES

National Grease Recycling Inc. Let us teach you how to recycle restaurant's waste fryer grease and oil (yellow grease) only. **No trap grease.** Big \$. Over 30 yrs. experience. Will guide you through complete process from collection to processing to marketing to end users. Don't lose your trap business to competitors that offer both services. Call for information. Dewey Walker. 813-752-9535 or 813-758-2552. (PBM)

Attention PolyJohn Owners: Receive a **free CD-Rom** of our products to use in your company marketing efforts. Ask your PolyJohn business coach in your area to send you this material today. 1-800-292-1305 Kell. (PBM)

BIODIESEL PROCESSOR, turnkey business opportunity, onsite training/operation, modular and house in cargo containers, react new or used vegetable. www.stopxon.com. (P12)

Looking for business partner for innovative restroom concept with proven market demand. Potential for European distribution as well. Concept is fully developed and ready for production. Contact 630-259-9310. (PT10)

PLACE YOUR AD ONLINE AT www.pumper.com - IT'S ALWAYS THERE TO MEET YOUR BUSY SCHEDULE

BUSINESS OPPORTUNITIES

HAVE LICENSE WILL SPONSOR. State of Florida. Own your own septic business; pumpout, repair, new installations, etc. Joe 321-784-1614. (P10)

ELIZAJ Franchise Opportunity-Nationwide accounts ... Looking for team players who want to be part of the "go to" company for quality portable restroom rentals. Turn key operation. Apply online at www.elizaj.com or call 800-437-1139. (PT01)

WWW.ROOTERMAN.COM. Franchises available with low flat fee. New concept. Visit web site or call 1-800-700-8062 x26. (CPBM)

INVENTION OF A TRASH CAN WITH NO BOTTOM. Can be used for recycling, leaves collection during fall or trash only. Patent pending. Fill the bag and lift the can, not the bag, and save your back. No workmen's compensation to deal with. Will allow licenses. You buy sub-wholesale and sell wholesale. This ad is to see if there is an interest. Production pending. Call 808-479-1876 or email kiscanllc@yahoo.com. (P03)

COMPUTER SOFTWARE

WINTAC is the #1 software for scheduling, CRM, billing, service tracking, accounting, marketing, vehicle management. FREE demo at www.wintacpro.com. 1-800-724-7899. (PI02)

Pumper Plus Billing Software: Regularly \$795. Mention this ad in Pumper.com and purchase for only \$595. Pumper Plus is a billing software package from Galaxy Systems, www.galsys.com/pumperdemo.asp, that handles billing for septic pumping and portable toilet service-type companies. Inquire at solutions@galsys.com or call 800-985-3029. (PBM)

DEWATERING

DAF, 6X12 F.R.C. All stainless steel w/2 dissolved air pumps. Top paddle and bottom worm drive skimmers removes suspended solids particles and colloidal materials from liquid waste, such as fats, oils, grease, latex, pump and paper fiber. Treating approx. 140 gallons per min. 770-917-0377. (PBM)

DEWATERING

2003 Simon Moos, KSA, roll-off, mobile dewatering unit. Truck not included. First \$60,000 takes it as is. Email or call for more details. aardvarkwaste@mac.com, 435-632-9002. (P10)

Buy - sell - trade - lease: Filter presses, belt presses, vacuum filters, filter cloth, dewatering bags, tanks, mixers and more! Call Waste Treatment Equipment Specialties at 440-808-8844. www.wescoequip.com. (PBM)

1989 BDP model E 1 meter belt press with rotary drum thickener, 2 - 500 gallon polymer mixing tanks, infrared heaters, fluorescent lighting, stainless steel flooring with fold out walkways, variable speed controls for sludge pump, rotary drum, polymer pump, and press section. All self contained in a 50' curtain side trailer with air ride, \$140,000 OBO. **Flottweg model 2-73 36" horizontal decanter centrifuge** with 8' gravity belt table, 2 - 500 gallon polymer tanks, infrared heaters, fluorescent lighting, stainless steel flooring with fold out walkways, variable speed controls for sludge pump, gravity table, polymer pump, and centrifuge. All self contained in a 50' curtain side trailer with air ride, \$395,000 OBO. **2005 BDP model 3DP 1 meter belt press** with 8' gravity belt table, 2 - 500 gallon polymer mixing tanks, infrared heaters, fluorescent lighting, stainless steel flooring with foldout walkways, variable speed controls for sludge pump, gravity table, polymer pump, and press section. All self contained in a 48' curtain side trailer with air ride, \$285,000 OBO. Contact Parker Ag Services at 719-775-9870 Ext 223 for Kipp or Ext 233 for Bob. (PM10)

Aqua Zyme 30-yard dewatering box with rollover top. Used for three months. Aqua Zyme 550 gallon polymer injection unit. Both look brand new. I will take payoff. Contact me at 706-234-7252. (P11)

Used IDS dewatering box 1 year old. Polymate Polymer unit like new. Inground holding tank pump. 1992 Freightliner roll off truck. Whole package \$50,000. 304-425-5329. (P12)

Alar, Model 650, very good cond. Completely automatic with all controls and panels, filters down to 1/2 micron, sludges generated by septic and grease haulers. Reducing BODs, F.O.Gs, TGS, total phosphorus, meters and NH3-N. 770-917-0377. (PBM)

DREDGES

Seepex sludge & polymer mixing & pumping unit. 5 years old. Excellent condition. Asking \$20,000 OBO. Call 1-506-672-2100. (PBM)

1984 Mudcat Dredge Model SP810. Completely reconditioned and new hull in 2005. All pipe, hardware, and semi trailer also available. \$52,500 OBO. Contact Parker Ag Services at 719-775-9870 Ext. 223 for Kipp or Ext. 233 for Bob. (PM10)

For Sale: 2-year-old lwt. Pithog, 20 hp, remote controlled dredge, 400 hrs. run time on unit. 80 kw Cat generator power unit with 528 hrs. and enclosed trailer with all piping, floats and appliances needed for dredging operations. 910-263-9461. (P10)

HAZARDOUS WASTE UNITS

2009 Sterling LT9500 triaxle with a new Presvac, **Powervac** 3800, 3,250 gallon (US), DOT, wet/dry industrial, vacuum tank loader. (Stock #13336) www.VacuumSalesInc.com, (888) **VAC-UNIT (822-8648)**. (PBM)

2000 Ford F-650 cab and chassis with a Presvac 1200 US gallon, DOT certified vacuum tank. **In stock.** (Stock #5721C) www.VacuumSalesInc.com, (888) **VAC-UNIT (822-8648)**. (PBM)

NEW Presvac 5500 gallon c/s DOT certified vacuum tank unit, self-contained. **In stock!** (Stock #13325B) www.VacuumSalesInc.com, (888) **VAC-UNIT (822-8648)**. (PBM)

2000 Kenworth T300 cab and chassis with a Presvac 2010 US gallons, DOT certified vacuum tank. **In stock.** (Stock #4675C) www.VacuumSalesInc.com, (888) **VAC-UNIT (822-8648)**. (PBM)

1986 Polar 5,000 gallon 316 stainless steel MC 307/312 vacuum trailer with hyd. vacuum pump drive. Spring suspension. In excellent condition. Must see. KLM Companies 617-909-9044. (P10)

2009 Peterbilt 365 tri-axle with a new Presvac, Powervac 3800, 3250 gallon (US), DOT, wet/dry industrial, vacuum tank loader. **In production.** (Stock #13340V) www.VacuumSalesInc.com, (888) **VAC-UNIT (822-8648)**. (PBM)

HAZARDOUS WASTE UNITS

2009 Freightliner 120 steerable tri-axle with new Presvac Powervac 3,800 cfm, DOT 412, wet/dry vacuum unit. 3,200 gallon tank with full open rear door with top loading boom. 450 hp MB engine with aluminum wheels and fully loaded. Buy or rent. KLM Companies/KLM Rentals Inc. Call 781-934-5437. (P10)

1997 Peterbilt 379 heavy spec with a 3200 gallon, carbon steel, DOT certified, **Cusco master vac** wet/dry industrial vacuum loader with dual baghouse, PD blower, rotary vane vacuum pump. Full open rear door dump unit. Very clean. (Stock #1499V) www.VacuumSalesInc.com, (888) **VAC-UNIT (822-8648)**. (PBM)

CHEMICAL BATCHING TRAILER-three large tanks, heat exchanger, two electrical Cat pumps, two large reels, a lot of accessories. \$75,000. 617-680-4569. (CP10)

2009 Peterbilt 340s **loaded with every option except with automatics** with a new Presvac 3200 gallon carbon steel, DOT 412 certified, **full open rear door, dump style units.** PVB750 vacuum pumps. (Stock #13335 A,B,C&F) *In production for May/June.* www.VacuumSalesInc.com, (888) **VAC-UNIT (822-8648)**. (PBM)

ATTENTION: Fleet of Mack vacuum, emergency response service trucks for sale/trade by owner. Tanks and misc. pumping equipment. 417-619-5111. (PBM)

JETTERS-TRAILER

Used PipeHunter model 38T44 jetting unit, trailer mounted unit, w/335 poly water tank, 4000 psi @ 25 gpm, 600' hose and attachments. **In Stock!!!** (Stock #4313V) www.VacuumSalesInc.com, (888) **VAC-UNIT (822-8648)**. (PBM)

Spartan 777 water jetter prototype, 3 cylinder Kubota engine. Missing pump, front door. Needs TLC. \$2,500 or make offer. 630-802-2471. (CP10)

New PipeHunter Model 38T44 jetting unit, trailer mounted unit, w/335 Poly water tank, 4,000 psi @ 25 gpm, 600' of hose and attachments. **In Stock!!!** (Stock #13317) www.VacuumSalesInc.com, (888) **VAC-UNIT (822-8648)**. (PBM)

JETTERS-TRAILER

1993 Sreco model HV2060 trailer jet, 35 gpm, 2000 psi, Myers pump, 500' of 3/4" hose, 600 gal. plastic water tanks. Was a city owned unit. 714-639-8352. www.empireequip.com. (CPBM)

2 SECA trailer jets. Both have Myers 35 gpm, 2000 psi pumps. New paint on both. Located in Dallas. 972-938-1905. www.empireequip.com. (CPBM)

New O'Brien Model 3518-SC jetting unit, trailer mounted unit w/350 poly water tank, 4000 psi @ 18 gpm, 400' of hose and attachments. **In Stock!!!** (Stock #3024V) www.VacuumSalesInc.com, (888) **VAC-UNIT (822-8648)**. (PBM)

JETTERS-TRUCK

1988 Ford F800 Sreco jet truck, 65 gpm, 2000 psi, former city truck, 47,300 miles, 1000 gallon water tank, Myers pump. 651-489-5185. (CPBM)

1990 Vactor Model 850 water jet on an International 4500, 65 gpm @ 2000 psi, 1500 gallon water tank. Good running condition. \$9,500. 714-639-8352 or craig@empirepipecleaning.com. (CPBM)

2006 GMC TC6500 cab & chassis truck mounted jetting unit with JET EYE camera system, 3,000 psi @ 50 gpm, 1,000 gallons water, 600' hose, 500 cfm blower, debris tank and attachments. (Stock #13234) www.VacuumSalesInc.com, (888) **VAC-UNIT (822-8648)**. (PBM)

JET VACS

2002 Vactor Model 2103 on an International 4700, 40 gpm, 2000 psi, **PD blower**, new white paint, **no CDL required.** Located in Dallas. 972-938-1905. www.empireequip.com. (CPBM)

1989 Ford L8000 Vac-Con, 86K miles, Allison automatic transmission, 3-stage fan, 9-yard debris tank, Gaso pump, John Deere aux. motor. \$20,000. 800-204-7615. (P10C11)

2001 Vac-Con V312LHA/1300, 12 cu. yd., 80/120 gpm 2000/3000 psi, 600' hose, Sterling LT7501 with Allison auto, extended rear wheel kit (legal with a full load). Loaded, low miles, low hours, ready to make you money! \$100,000 firm. CA 916-416-7901. (CP11)

BUY IT - SELL IT - PLACE IT - www.pumper.com - AVAILABLE ANYTIME, ANYWHERE, ANY DAY

JET VACS

1986 Vactor 1200 on a Ford L-8000 w/3208 Cat w/Allison auto, 68000 miles. Pony motor, 6V53 Detroit w/4365 hrs. Body washout, recir. and anti-freeze systems. \$18,000. Jim @ 313-849-2667. (CP11)

1998 Vac-Con Model V350THA, 3-stage fan, 50 gpm, 3000 psi pump, 5-yd. debris tank, new white paint. Was city owned. 714-639-8352. www.empireequip.com. (CPBM)

2008 Sterling LT7501 with a Vac/All Safe Jet Model AJV1215 1500 water comp, 12-yd. debris body, Roots 824 PD blower, 80 gpm @ 2000 psi jetting system with 600' of 1" hose. Combination vacuum-jetter unit. **In stock - RENT ME!!!** (Stock #0329V) **www.VacuumSalesInc.com, (888) VAC-UNIT (822-8648).** (PBM)

2006 Vac-Con, only 22,000 miles, 12-yard debris, 3-stage fan, 1300 gallons, spec sheet is available. 801-301-3017. (MPT110C11)

1994 Guzzler, Ford LNT8000, 126,250 miles, 275 hp, auto transmission, 9-cy debris tank, 16" Roots blower, Myers water pump, 2000 psi @ 80 gpm, 1500 gal. capacity, 8' extendable boom. Good condition. Asking \$67K OBO. 716-523-6813 after 5:00 pm. (CP10)

1997 Clean Earth, Ford LNT 8000, 98,575 miles, 275 hp, auto transmission, 4-cy debris tank, 16" Roots blower, Myers water pump, 2000 psi @ 80 gpm, 2000 gal. capacity, 4' extendable boom, rear mount hose reel. Good condition. Asking \$52K OBO. 716-523-6813 after 5:00 pm. (CP10)

1996 Vac-Con LTL 8000, automatic, 275 hp, 50 gpm, 3000 psi, telescoping boom, 3-stage fan, 10-yd., 1000 gallon water, good running truck, in good condition. \$85,000. Mahoney's Equipment LLC. 1-877-282-4949. Ask for Steve. (CP10)

2002 Vactor 2112 on a 2002 Sterling, 80 gpm, 2500 psi, **PD blower**, new white paint. Located in Dallas. 972-938-1905. www.empireequip.com. (CPBM)

1998 Vac-Con V312THA on a Ford LT8000, 3-stage fan, 65 gpm, 2000 psi pump, extendible boom, articulating hose reel, 12 yard debris tank, new paint. Was a city owned unit. Located in Dallas. 972-938-1905. www.empireequip.com. (CPBM)

JET VACS

Monster of a truck! 2005 Vac-Con V311/1300, 10' aluminum telescoping boom, front-mounted hydrostatic drive, 600' x 1" 2500 psi/6250 - 200'. \$215,000. 970-494-1610. (P11C12)

1998 Clean Earth, Ford Louisville, 136,900 miles, 275 hp, 10-speed Eaton Fuller, 10-cy debris tank, 27" Roots blower, variable speed Myers pump, 2000 psi @ 80 gpm, 1500 gal. capacity, 8' extendable boom. Also serves as a hydro-excavator. Good condition. Asking \$82K OBO. 716-523-6813 after 5:00 pm. (CP10)

1994 Vac-Con model V311-TA, 3-stage fan, 11-yd. debris tank, 50 gpm, 3000 psi pump, new white paint. Was city owned. 972-938-1905. www.empireequip.com. (CPBM)

2002 - 1991 Vactor 2100s in stock and ready to work. Models available equipped with either PD or fan style blower, 80 - 60 GPM pumps, mostly fully loaded, ex-municipal units with low hours and miles. Call Joe 312-208-6373. (P10)

Vac-Con model VPD4209THA on a 1997 Ford, **PD blower**, 4200 cfm, articulating hose reel, extendible boom, new white paint. Was a city owned unit. In excellent condition. 972-938-1905. www.empireequip.com. (CPBM)

Jack Doheny Supplies Inc. offers a full range of late model combo units and DOT industrial vacuum loaders. Call us @ 1-800-3DOHENY. (CPBM)

1998 Vactor 2110 on a Freightliner FL80, 28,213 miles, 2-stage fan, 80 gpm, 2,000 psi pump off system accumulator. Was a city owned unit. Located in Dallas. 972-938-1905. www.empireequip.com. (CPBM)

1997 Vac-Con V390THA on a Ford, 3-stage fan, articulating hose reel, extendible boom, new white paint. Located in Dallas. 972-938-1905. www.empireequip.com. (CPBM)

LEASE/FINANCING

NEW AND USED EQUIPMENT FINANCING. Quality off lease and reconditioned repos available to buy, lease or rent. Competitive rates and flexible terms. **Call Brad @ 610-942-3930.** (PBM)

LEASE/FINANCING

BSM Financial Group is a nationally recognized finance company. We offer flexible payment schedules for all types of equipment new or used. Trucks, pumps, jettors, portable toilets, and software easily financed. We do first time start-ups, established businesses, and challenged credit. **Call Brett at 877-524-7972 or email brett@bsmfinancialgroup.com.** (PBM)

North Star Commercial Credit: Commercial Loans for Trucks or Equipment. Flexible purchase programs to fit your budget. 21 yrs. in the industry. Contact **Tom Myers - 877-804-2274.** (CPBM)

Grow Your Business Today! Get competitive financing. No payment for 6 months. Seasonal plans! No age restriction. Don't wait. Liberty Capital Group, Inc. 888-798-3976. (PBM)

MISCELLANEOUS

1987 F-700, diesel, 5 speed, 2000 gallon hydraulic lift, fully opening rear end tank, good for hauling & dumping mud, 310 cfm pump, \$6900. 405-235-8600. (P11)

Top quality aerators at wholesale prices. We have replacement units for most name brands and also carry Linear Regenerative Rotary Vane pumps. Flagg Air, Gast, Thomas, FPZ, Secoh, Medo and more. Call a company that understands aerators and aeration systems. Septic Services Inc. 800-536-5564. (CPBM)

DISCOUNT ALUMINUM: ARE YOU PAYING TOO MUCH? 1,000 lb. minimum quantity. 5052/5454/5083/5086. .063 - 5.0" thick. All widths. Contact Jayson. 1-888-540-0066. (PBM)

1985 Brown Bear Model 1 compost turner, hydrostatic drive, 4 position steering, Cummins motor, good teeth, 1385 hours, excellent condition. \$49,900 OBO. Contact Parker Ag Services at 719-775-9870 Ext. 223 for Kipp or Ext. 233 for Bob. (PM10)

FOR SALE: Aqua Weed Harvester Power by Perkins engine. Cut 10' wide, 6' deep. Complete with trailer. Can arrange delivery. Asking \$35,000. Phone Ron @ 204-248-2559 or email info@lagooncleaning.com. (P10C11)

PARTS & COMPONENTS

PARTS & SERVICE for vacuum pumps and vacuum tanks. Vacuum pumps also in stock. 800-909-6909. Ask for Ken or Randy. (PBM)

PORTABLE RESTROOMS

TSF Portable Restrooms, green or teal, \$50-\$100 (250 units); Satellite Maxim 2000 & 3000, blue \$200 (80 units); Satellite Maxim 2000 & 3000 VIP units, blue, \$250 (30 units); Satellite Freedom accessible units, grey, \$400 (20 units); Satellite Tufways, teal w/grey doors, \$250 (140 units); PolyJohn Hi Rise units, grey, \$225 (35 units), Odor absorption filter - TV 1000 General Carbon Corp. for deodorizing pump exhaust. 42" dia. chamber, 62"H, with quick fittings. Just hook to vacuum pump exhaust. Eliminate undesirable odors in your yard. Will deliver within 500 miles of New Jersey "for actual cost." Call 732-721-3443 or email mhyer@johnnyonthespot.com. (P10)

500 Olympic Fiberglass units for sale. Units are older construction grade. Located in Albuquerque, New Mexico. \$100 each. Call 505-345-3965. (PT12)

75 PolyJohn PJ3s. Aqua & yellow. Fair condition. \$100 to \$150 each. Southern MI. Ph: 248-437-5595 Email: johnsanit@yahoo.com. (P10)

Half Units: Good condition, 300 PolyJohn half units and 300 sling units and regular units for sale. Contact Manuel @ 305-970-9837. (P10)

Hundreds of POLs, 2 years old, assorted brands and assorted colors for \$150 a POL. Please call for more info and pictures via email. 561-202-2355. (P11)

Portable toilets (regular and handicap units) and two service trucks for sale. Visit aplusportapotty.com for pictures and to e-mail or call 352-266-0183. (PT11)

Two-year-old Satellite Freedom 2 ADA-handicap, sand/tan color, only used a few times. 7 available. \$1,400 each or trade for Tufway. 641-521-3187. (PT10)

50 tan Hampel portable restrooms; new, never used. Las Vegas. \$450 each or all 50 for \$400 ea. Pictures www.acoinc.com/classified. 208-362-3193. (P10)

PORTABLE RESTROOMS

MUST SELL: 400 grey PolyJohn PJ-III toilets. All less than 4 yrs. old. Asking \$300 each OBO. All ready to use. Will discount for quantity purchases. FL 941-473-5419 or erin@amberjack-inc.net. (PT01)

80 dark blue PolyPortables units for sale. 3 years old or less. Good for construction, some ok for events. Possible delivery available. \$250 ea. 770-443-0131 Atlanta. (P10)

Used PolyJohn, PolyPortable tan units, plastic skids, average to excellent condition. \$225-\$325 each. Can arrange shipping. Call Bob at 1-352-796-4540. (PBM)

300 used Polyjohn Fleet Units for sale. Brown, good condition. \$150 each. Call Gina 352-369-5411 ext. 206 or email gina@floridaexpress.us. (CPT11)

For Sale: 30 to 50 used Poly-Portable restrooms, 8 to 9 years old, in good condition. \$150 each OBO. Call 410-795-2947. (P10)

Over 600 PolyJohn units 1-2 years old. Starting at \$300 each. Minimum purchase of 26 units. 772-562-4604. kim@reliablepolyjohn.com. (PBM)

Portable Toilets: Poly constructed, molded seat, urinal, latching door. Handicap accessible units available. New and used. CC/Brian Touey 805-896-3777. (PBM)

I have 49 unassembled Synergy Taurus units for sale. Location Olympia WA area. Call me at 360-894-2254 or cell 360-239-8854. (P11)

PORTABLE RESTROOM TANKS

Used 2003 Satellite MD 950 tank in excellent condition. Includes work-lites, toolboxes, freshwater pump, 650 waste, 300 fresh, ready to mount on truck. Includes Satellite 2 toilet carrier and Conde 6SS vacuum pump. Tank came off 2003 Ford 550. \$13,000 OBO. 231-924-8994. (PT10)

Single or multiple compartment tanks. Choose mild, stainless, or galvanized steel. Capacities from 100 to 6000 gallons, any diameter. Parts and accessories to build your own and save money. 800-545-0174. www.tanksandpumps.com. (PBM)

PLACE YOUR AD ONLINE AT www.pumper.com - IT'S ALWAYS THERE TO MEET YOUR BUSY SCHEDULE

PORTABLE RESTROOM TRAILERS

New 2008 24' Olympian, (3) women, (4) men, \$27,000. 2001 26' Olympic (4) women, (4) men, \$20,000. 1999 & 2000 Olympic 30' Luxury Liners, oak interior, private rooms, (3) women, (4) men, \$22,000 each OBO. All have heat, AC, and hot water. 866-883-9538. (P11)

2006 Wells Cargo Comfort Elite III. Light use, stored indoors. 573-896-8665. (PT11)

Trailers for sale, separate or together. Must sell, reasonable. View pictures at www.comfortcoaches.com Contact: Don 443-867-9883 or dsauer1751@aol.com. (PT12)

Restroom Trailer - Gold Series: 32', new and used. Women's - 5 stalls, 2 sinks. Men's - 2 stalls, 2 urinals, 2 sinks. CCI/Brian Touey 805-896-3777. (PBM)

New and used **RESTROOM TRAILERS** available immediately. 8 to 34 foot luxury trailers. Comforts of Home Services Inc. 877-382-2935. (PBM)

Restroom Trailer - Platinum Series: 30', new and used. Women's - 4 stalls, 2 sinks. Men's - 2 stalls, 3 urinals, 2 sinks. CCI/Brian Touey 805-896-3777. (PBM)

PORTABLE RESTROOM TRUCKS

2000 Chevy 3500HD 7.4L 2-wd., 78,000 mi., 4-spd., auto., 400 waste, 100 fresh. NEW Conde pump and motor. 6-place toilet hauler. NEVER SEEN SALT!!!! 80% tires. ready for pumping! \$18,500 OBO. 715-281-8221. (P10)

2006 Ford F-550 4x4 XLT, 70K miles, new engine and brakes, Satellite 950 model fresh water wand, 2-unit hauler. SHARP. \$42,000. 641-420-5310. (P11)

2007 XL Super Duty F550 4x4, Satellite tank 650/250 backpack dual side, 200,000 warranty, excellent condition, 44,000 miles. \$52,000. 208-253-6021. (CP10)

1997 F-450 XL 650/250. Replaced engine & transmission 20,000 miles ago. Installed Masport pump about 1 year ago. Great truck as a back up truck or starting new business. \$10,750 OBO. Call 931-553-8200. (P11)

PORTABLE RESTROOM TRUCKS

STOCK UNIT READY TO ROLL: 2007 Isuzu NPR-HD (pre-emission) chassis up-fitted with **Model 800** (550/250) **Crescent Rectangular Vacuum Tank**. **REDUCE** fuel costs and **IMPROVE** productivity with the **all-in-one** vehicle (service & pick-up/delivery). Great price and they won't last. Isuzu NRR also available Call for quote today. **Crescent Tank Mfg.** 585-657-4104; www.crescent-tank.com. (P10)

2002 INTERNATIONAL DT466 4300 auto, air brakes, 217K, Wallenstein pump-rebuilt 4/08. Steel tank 1000 waste/400 fresh. \$15,000. patflynn2@aol.com 330-351-4353. (P10)

1989 Ford LNT 9000, 52000 GVW, 300 Cummins, 9-spd., A/C, PS, air brakes, 3600 gallon tank, Masport water-cooled pump, 21" manway, 26" rear manway, 6" dump. Tank and cab white. Engine overhauled 695 miles since. Price is \$27,000. Located in Las Vegas, NV. Pictures at www.acoinc.com/classified. Call 208-362-3193. (P10)

2006 Dodge 3500, Cummins 4x4 Quadcab, 6-spd., 84,000 miles, flatbed w/510 gal. waste, 250 fresh. \$27,500. 208-253-6021. (P10)

Aluminum Portable Restroom Tankers: '02 F-650, 158K, \$35,500; '02 Isuzu, 248K, \$29,150; '02 Inter., 206K, \$31,450; '02 Inter, 154K, \$32,450; '03 Inter, 236K, \$43,500; '03 Inter., 196K, \$44,000. Masport pumps, pressure cleaners, 500 clean, 1500 waste. Contact Manuel @ 305-970-9837. (P10)

2006 XL Super Duty F550 4x4, Satellite tank 650/250. Backpack boxes, excellent condition, 200,000 extended warranty, 71,470 miles. \$47,000. 208-253-6851. (CP10)

2004 Ford F550 Super Duty diesel pump truck. White with gray interior, Best built with a 1050 gallon stainless steel tank, PTO driven Masport pump. Perfectly maintained by Gabrielli Ford in Jamaica, NY. Wholesale price of \$29,500. 800-634-2085. (PT12)

Dreaming of a Crescent Rectangular Vacuum Tank? And you have an existing chassis... **Crescent Tank Mfg.** will up-fit or ship to you tank only. Call to get tank only quote. **Crescent Tank Mfg.** 585-657-4104; www.crescent-tank.com. (P10)

PORTABLE RESTROOM TRUCKS

Used Crescent Tank; '04 Model 900 (650/250) up-fitted to a used '04 Chevy 4500. Call for further specs and price. **Crescent Tank Mfg.** 585-657-4104. (P10)

2003 F450 well maintained super duty, turbo diesel 4x4, auto w/towing pkg., air, 2004 Dynavac 500 gal. waste, HXLV3 Masport, 250 gal. water w/stainless 20 gpm pump. Both sides service, lg. storage compartments, 2-toilet rack. Ready to work. Brewer's Septic. 800-500-5096 NY. (P10)

2002 4300 International, 25500 GVW, DT466, Allison, A/C, air brakes, 3-compartment tank (450/950/250), M-10 Moro pump, spot lights, 2 Burk water pumps for fill and spray down, restroom carrier. Pictures www.acoinc.com/classified. Located Phoenix, AZ. \$35,000. 208-362-3193. (P10)

1998 International 4700 with a 1,500 US gallon, 2-compartment (1100/400 split), carbon steel, portable toilet service unit. (Stock #8734C) **www.VacuumSalesInc.com, (888) VAC-UNIT (822-8648).** (PBM)

2007 Dodge 2500, Cummins 4x4 Quadcab, 6-spd., 44,000 miles, 8' steel flatbed, 300 gal. alum. waste, 135 fresh, w/lift gate. \$31,500. 208-253-6021. (P10)

(1) 1997 Int. 4700, pickup/delivery, 600 gal. (400/200); (1) 1999 Int. 4900, service truck, 2100 gal. (1600/500); (1) 2000 Int. 4900, service truck, 2100 gal. (1600/500); (2) 2001 Int. 4900, service truck, 2100 gal. (1600/500). Excellent front line units. 1-352-796-4540. (PBM)

2002 International Pumper Truck: 4700 series, DT466, automatic, air brakes, 1200 gallon waste, 300 gallon fresh water, Masport 75 pump. CCI/Brian Touey 805-896-3777. (PBM)

2000 Isuzu NPR with Workmate Model 750, 500 waste, 250 water, with Masport pump and Masport odor control. Good rubber, 227,000 miles. Engine has 150,000 miles. Priced to sell. \$13,900. Call Frank King 978-452-7750. (P10)

2008 Dodge 5500, Cummins 4x4, Quadcab, 6-spd., 18,000 miles, 9' aluminum bed w/boxes, 510 gal. steel waste, 300 gal. fresh, electric start pump. 208-253-6021. (P10)

PORTABLE RESTROOM TRUCKS

2002 Ford F-450, 75,000 mi., \$19,500, 7.3 turbo diesel, 6-spd. manual, hyd. brakes, A/C, PTO Masport HXL2F, Satellite 250/450 tank, water pump w/hose reel, 2-unit carrier, GVW 15,000; 2005 International 4300, 109,000 mi., \$33,000, DT466, auto Allison MD3060, air brakes, A/C, PTO Masport, HXL3WF, Presvac 200/1000/200, water pump w/hose reel, 2-unit carrier, GVW 32,360; 2006 International 4300, 89,000 mi., \$35,500, DT466, auto Allison 2100, hyd. brakes/exh. brake, A/C, PTO Masport HXL3WF, Prime 200/1000/200, water pump w/hose reel, 2-unit carrier, GVW 25,999; 2006 International 4300, 96,0000 mi., \$35,000, DT466, auto Allison 2100, hyd. brakes/exh. brake, A/C, PTO Masport HXL3WF, Prime 200/1000/200, water pump w/hose reel, 2-unit carrier, GVW 25,999; 2003 Ford F-550, 114,000 mi., \$34,500, 6.0 turbo diesel auto, hyd. brakes, A/C, PTO Masport HXL3WF, Prime stainless steel tank 150/800/150, water pump w/hose reel; 2004 International 7400, 97,000 mi., \$48,500, DT466, auto Allison MD3060, air brakes, A/C, PTO Masport HXL2F, Presvac 300/1100/250, water pump w/hose reel, 2-unit carrier, GVW 33,000. Call 732-721-3443 or email mechanic@johnnyonthespot.com. (P10)

2005 International 4300 with a 2000 US gallon, 2-compartment (1500/500 split), aluminum, portable toilet service unit. \$58,000. **In stock!!!** (Stock #9153C) **www.VacuumSalesInc.com, (888) VAC-UNIT (822-8648).** (PBM)

2007 Ford F650 Satellite 1250 Service Truck. 850 waste/400 fresh with 2-unit toilet carrier. Conde pump, purchased 11-07, low miles, \$61,900. N. Illinois 815-946-2813. (PT10)

2001 4700 International, 25500 GVW, engine DT466, 7-spd./OD, A/C, air brakes, 3-compartment tank (450/850/200), M-10 Moro vacuum pump, spot lights, pressurized water spray down & fill, restroom carrier. Pictures www.acoinc.com/classified. Located Salt Lake City, \$30,000. 208-362-3193. (P10)

1996 International 4700 with a 700 US gallon, 2-compartment (500/200 split), carbon steel, portable toilet service unit. **In stock!!!** (Stock #6921V) **www.VacuumSalesInc.com, (888) VAC-UNIT (822-8648).** (PBM)

PORTABLE RESTROOM TRUCKS

New 700 US gallon 2-compartment (450/250 split), carbon steel, portable toilet service unit. (Stock #13238V) **www.VacuumSalesInc.com, (888) VAC-UNIT (822-8648).** (PBM)

1999 Mitsubishi 600/225, auto, A/C, diesel, 242,000. Ready for service. \$12,500. Located in PA. 800-433-2070. (P10)

2008 Ford, 49,000 miles, \$45,000. 2007 C5500 Chevrolet, miles in 40s with aluminum and steel tanks. Still under warranty. Slide-ins 600/200, \$10,000. Portable toilet transport trailers: 8, 10, 12, 14, 16, 20 haulers. New portable toilet trucks and new and used septic trucks. We stand behind everything we sell. Lane's Vacuum Tank Inc. 1-800-592-3308. (PBM)

1999 Isuzu FTR, 190 hp, 6 cyl. diesel, 25,900 GVW, new Allison auto with 2-yr. warranty, Jay's Inc. 1,300 gallon 800/500 split, National 190 cfm vac. pump, Burks DC-10 wash down pump, heated dump valve, heated bucket fill, heated water pump, 60' hose reel, 2-unit toilet carrier, and more. 123,800 miles. \$35,000. Call Dale 708-878-4391. Located in Illinois. (PBM)

POSITIONS AVAILABLE

Drain Cleaner Wastewater Management Company seeks experienced sewer and drain cleaner for commercial work out of our Deptford, NJ location. Must have a clean driving record and 3 yrs. experience utilizing power drain cleaning equipment. CDL a plus. Good salary and excellent benefits. Send resume to: Russell Reid Company, 200 Smith St., Keasbey, NJ 08832. Fax: 732 225-1738. hr@russellreid.com. (P11)

Central Alabama industrial service company is currently accepting resumes for experienced foreman, supervisors and managers. Must be familiar with industrial service practices, air movers, hydro blasters and be able to manage multiple job sites and employees. CDL with X a plus. Managers should have demonstrated abilities in personnel, financial, and fleet management. Competitive compensation package and benefits. Interested applicants may respond to apply.hr@hotmail.com. (P10)

POSITIONS AVAILABLE

Pipeline Investigations Inc., a Baltimore, Maryland firm, is seeking qualified persons to operate jet vac trucks, mainline CCTV cameras, and/or lateral push cameras. Experience with Ferro Mag locators and sondes a plus. Salaries negotiable based upon experience. Fax resume or personal info. to 410-242-1038 or email fleetbarnes@pipelineinvestigations.com. (CP12)

Regional Sales Manager for US Eastern Seaboard & Gulf Coast States, selling mobile vacuum cleaning equipment used in the cleanup and transportation of hazardous and non-hazardous liquid, semi-solid and dry waste materials. The industries that we cover are environmental remediation companies, automotive, pulp and paper, mining, oil and gas, steel, power plants, septic cleaning and manufacturing. Must have an understanding of the environmental liquid waste remediation industry, and a working knowledge of vacuum cleaning applications. They must have a minimum of 5 years experience with a proven sales record. Contact stanj@wastequipcusco.com, 1-800-490-3541 ext 274

(P10)

OUTSIDE SALES: So. California. Cable/pipe locators, pipe inspection cameras and leak detection equipment. \$50-\$75K+ **potential!** Must have working knowledge of above equipment, together with outside sales experience. jjones@wctproducts.com. (CM10)

PUMPS-SUBMERSIBLE

Hydraulic Submersible Pumps: Four 4"- approximately 1000' + or - of hydraulic hoses. \$7,500. 617-680-4569. (CP10)

Wholesaler for Hydromatic, Zoeller, Myers, Liberty and ABS pumps. We also supply Grinder pumps and basins. Will help you size them. Septic Services Inc. 800-536-5564. (CPBM)

PUMPS-VACUUM

Vacuum Pumps - New, used, or rebuilt. 30 to 900 cfm. All major brands; air, water, or fan cooled. Rebuild specialists - rebuilt PB, M3, M10, and others available. 800-545-0174. www.tanksandpumps.com. (PBM)

PUMPS-VACUUM

500 CFM Fruitland Pump, rotation, left; new, purchased from Specialty B Sales in Arkansas. Sold truck; don't need. \$4,200 + freight. Ray 512-825-1278. Austin TX. (P10)

Need a vacuum pump for your portable pumper? Try our new 30 cfm, 12 volt system. Less noise, no fuel. Automatic oiling, cheaper than a gas engine. 800-545-0174. www.tanksandpumps.com. (PBM)

Complete line of Moro, Conde and engine-driven, stand-alone pump systems, DC10 washdown pump. Call us for any of your vacuum truck parts from shut-off valves, primary and secondary valves, hoses, vacuum pumps and drive systems. Septic Services Inc. 800-536-5564. (CPBM)

New **Masport** and **Jurop** vacuum pumps. Compare our price before you buy. "Free shipping." W-K Machine & Supply Co. Call 1-800-633-8947. Distributor. (PBM)

PUMPS-WATER

Thompson 4" double-diaphragm pump, 5 hp. Pumps water, mud, sludge. Located in North Carolina. 910-738-5311. (P10)

RENTAL EQUIPMENT

Liquid vacs, wet/dry industrial vacs, combination jetter/vacs, vacuum street sweeper & catch basin cleaner, truck & trailer mounted jetters. All available for daily, weekly, monthly, and yearly rentals. **VSI Rentals, LLC, (888)VAC-UNIT (822-8648) www.vsirentalsllc.com.** (PBM)

ROLL-OFF TRAILERS/TRUCKS

1999 Benlee (2) Two container roll off trailer. 75,000 hoist with alum. Budds. Great condition Just painted. \$29,500. KLM Companies. Ph: 617-909-9044. (P10)

1998 Volvo WG64 quad axle roll-off truck w/auto tarp system, 200K miles, excellent condition. \$64,999. KLM Companies. 617-909-9044. (P10)

1993 Galbreath AC416 single container roll-off trailer. Bridge weight design. Just sandblasted and painted with aluminum Budds. Good condition. \$19,500. KLM Companies. 617-909-9044. (P10)

SEPTIC TRUCKS

1998 International DT 466, 2600 gal., Masport pump, both 4 years old, 6-speed, great truck, rebuilt engine, paint good. \$26,000. 434-531-2720 Dan. (CP11)

1997 Ford, 173K miles, 2500 gallon Presvac unit, telescoping dump tank, full opening rear door, Presvac PVD 750 pump. \$20,000. 800-204-7615. (P10)

2004 Peterbilt Model 330C, 76,000 mi., 300 Cat, 3600 gal. tank, TSI500 pump, 3", 4", 6" heated valves, air ride, AC, locking differential and tandems. \$85,000 OBO. Call for more info. 715-484-7711. (PBM)

1993 International, 5-speed, 2300 gal., excellent condition, factory rebuilt engine, new tires, brakes, all chromed wheels, very clean. \$26,500 OBO. 919-639-9420.(P11)

1997 Peterbilt Model 357, CAT 3306 motor, Fuller 8-speed trans., 4200 gal. Transway tank, 800 Transway pump, 220K miles, red. Excellent condition, ready to work. \$55,000. 978-618-6110. (PBM)

1998 Peterbilt, Cat 3126 engine, Wallenstein 553HRVOA vac pump, 2500 gal tank, 149,000 miles, new tires, 150' hose, excellent condition. S.E. Iowa. \$40,000 OBO. Ken 319-648-2708. (CPI-10)

1995 Ford L8000. 7-spd. Cummins diesel. New upholstery, new paint Dec. 2007. One owner. Bought new. 3000 gallon tank, 210,000 miles. 850-837-7200. (CP12)

2000 Chevy 630 van, diesel engine rebuilt, has 25K miles, new tranny, interior racks/shelves set up for drain cleaner. \$3,000 OBO. 230-838-7000. (CP10)

2003 International 4300, DT466, non-CDL, air brakes, 1500 gal. Abernethy tank, heated valves, clean, dependable, excellent condition, 200,000 miles. \$39,000. 715-772-3442 Wis. (P11)

1994 L8000, 2,500 gallon steel; 210 hp Cummins diesel, 306,603 miles; 6-speed transmission, 2-speed rear axle, air brakes, 33,000 GVW, good rubber; 48" and 60" aluminum toolboxes, stainless catwalks, 4" front/rear intakes, 6" discharge, brand new Masport H15W water-cooled (10 hrs.); reliable truck, one owner; \$24,500. Tim 513-755-8050, mikeullman@winelco.com. (P10)

SEPTIC TRUCKS

1994 IH 4900, 2100 gal. Imperial tank, sand blasted, painted, new line X, Jurop 260 pump, new engine, brakes, tires, 235K miles, sharp. \$22,500. 641-420-5310. (P11)

1999 International 4700, 50,000 miles, 2200 gal. tank, excellent running condition. Must sell. \$40,000. Call Tim. 203-748-1123. (P11)

1986 Mack 250, 2000 gallon, Masport pump H5V, Onan 13 hp pony motor, 5 sections of 3" hose, \$7,500. Call 715-463-3966. (P10)

1986 Mack, kitted in 1995, new 3400 gal. tank, 720 water cooled pump, rear end rebushed, new brakes and adjusters, 18,000 frts., 44,000 rears, work horse. \$34,000. Call Mike 612-221-8996. (P10)

2009 Peterbilt 340, automatic with a Presvac 3600 gallon (US) aluminum vacuum tank unit. **In stock!!!** (Stock #13346) **www.VacuumSalesInc.com, (888)VAC-UNIT (822-8648).** (PBM)

1990 Ford L8000, 7.8L 240 engine, 6-speed, 1500 gallon tank with Badger pump. Good starter truck. \$4,000. Call 219-325-3430. (P10)

Pre-owned Coleman tank (tank only), 3,300 gallon, c/s, 2 comp. (2000/1300) vacuum-pressure tank. **In stock!!** (Stock #0247V) **www.VacuumSalesInc.com, (888)VAC-UNIT (822-8648).** (PBM)

1992 International 4900 DT466, 250 hp, 10-spd. F/R 3500 Transway, good rubber, re-bushed Hendrickson. Runs, stops and pumps. \$8,000. 508-341-3559. (P11)

2006 Sterling Acterra, Mercedes-Benz powered, has 22,000 miles. Direct drive pump R260. Price: \$56,420. 850-682-4021. (PBM)

(1) 1989 Mack RD 690 S/A, 2500 gal.; (1) 2000 Int. 4900 S/A, 2500 gal.; (1) 1994 Mack DMM T/A, 3500 gal. Excellent front line units. 1-352-796-4540. (PBM)

2001 Mack RD686ST heavy spec. with a 3200 gallon **stainless steel** vacuum tank, large tool boxes, NVE 466 Challenger pumps. Excellent truck; very well maintained by one operator. (Stock #7948V) **www.VacuumSalesInc.com, (888)VAC-UNIT (822-8648).** (PBM)

SEPTIC TRUCKS

2000 Mack E7 427 tandem, locking differential, Jake brake, 3000 gallon tank, 400 cfm liquid cooled Masport pump, 360,000 miles, 3' load, 6' dump. Tank and pump less than 1 year old. Truck runs great. Colorado. \$52,000. 719-689-7867. (P10)

1989 Ford L8000 with a 3250 US gallon, carbon steel vacuum-pressure tank. **Available now!** (Stock #8474C) **www.VacuumSalesInc.com, (888)VAC-UNIT (822-8648).** (PBM)

2009 Peterbilt 340 with a Presvac 3600 gallon (US) aluminum vacuum tank unit. **In production.** (Stock #13337 A,B,C&D) **www.VacuumSalesInc.com, (888)VAC-UNIT (822-8648).** (PBM)

Pre-owned Presvac tank (tank only), 3000 gallon, s/s vacuum-pressure tank. **In stock!!** (Stock #1570V) **www.VacuumSalesInc.com, (888)VAC-UNIT (822-8648).** (PBM)

2001 Intl. DT-466, 7-spd. tandem, new 3600 gal. tank, Masport 350 cfm vacuum pump, 237,000 miles, \$49,000. 2000 Intl., DT-466, auto., new 2300 gal. tank, 350 cfm Masport pump, 147,000 miles, \$44,000. Other new & used toilet & septic trucks available. Everything we sell has warranty. Lane's Vacuum Tank Inc. 1-800-592-3308. (PBM)

1988 GMC Brigadier with a 2300 US gallon carbon steel vacuum pressure tank. **Available now!** (Stock #0231C) **www.VacuumSalesInc.com, (888)VAC-UNIT (822-8648).** (PBM)

Need a tank and truck, any size, any make truck? Let us help you get the best deal. Custom built to your specs. For information and a price quote call 800-545-0174. www.tanksandpumps.com. (PBM)

Pre-owned Presvac tank (tank only), 3000 gallon, c/s vacuum-pressure tank. **In stock!!** (Stock #3147C) **www.VacuumSalesInc.com, (888)VAC-UNIT (822-8648).** (PBM)

2008 Peterbilt 340 **loaded with every option except with automatic,** with a new Presvac 3600 gal., aluminum vacuum tank unit. Masport HXL400WV pump. (4) 2009 Models coming in May/June. (Stock #13297E). **www.VacuumSalesInc.com, (888)VAC-UNIT (822-8648).** (PBM)

PLACE YOUR AD ONLINE AT www.pumper.com - IT'S ALWAYS THERE TO MEET YOUR BUSY SCHEDULE

SEPTIC TRUCKS

1985 Ford F-700 370 auto-gas, 1800 gallon waste, 120 gallon fresh, steel tank (7 yrs. old), Jurop pump. \$16,500 OBO. 210-385-1055. (P11)

SHOWER TRAILER

Shower Trailer - Gold Series: 32', new and used. Men and women sides each have 3 private shower stalls with changing area, 1 restroom stall, 1 sink. CCI/Brian Touey 805-896-3777. (PBM)

SLIDE-IN UNITS

Slide-in tank, Best portable tank, stainless 300/110, 2005 model, good condition. \$6,500 OBO. Call Ray Kersh at 281-802-9016. (PT10)

Back up/Start up - Complete package; '07 Slide-In unit (250/200), '07 Dodge 2500 4x4. Slide-in unit has a Masport pump with a Honda electric start 5hp engine. The '07 Dodge has a HO Cummins diesel engine with a 6 speed transmission. See pictures on website www.crescent-tank.com. **Crescent Tank Mfg.** 585-657-4104. (P10)

SLUDGE APPLICATORS

1979 Terra Gator 2505, 3000 gallon liquid vacuum tank with injectors. 903 Cummins motor, 10-speed transmission, incorporation bar. \$25,000 OBO. Contact Parker Ag Services at 719-775-9870 Ext. 223 for Kipp or Ext. 233 for Bob. (PM10)

1987 I.M.E. Super/Jector 3500 gal. vac/pressure tank, 250 hrs. on 3208 Cat re-man. motor. Pearson PB8 vac pump, four-knife shank, tires 66x43.00/25 at about 60%. Unit in good condition. **\$31,000 OBO.** Day: 810-560-3268; Evening: 734-878-5228. (PBM)

(2) 8150 Knight slingers, 2005 and 2006 models, one owner, excellent condition. \$45,000 each OBO. Contact Parker Ag Services at 719-775-9870 Ext. 223 for Kipp or Ext. 233 for Bob. (PM10)

TANKS

2 used 2,500 gallon steel tanks, 3" 2-4" intakes, 20" double manholes. \$3,500 each. Boxes and pump available. Located in Wisconsin. 608-833-1263. (P11)

1500 gal. septic tank w/Moro pump, \$2,500. Truck C70 1983 available, \$2,000 - for tank to sit on. 815-626-1956. (P10)

Used Ag-Chem 3500 carbon steel Presvac, top load hatch, complete pump system included. \$3,500 OBO. Fremont, NE 402-690-8058. (P9M10)

FRAC/Storage tank for sale. 20,000 gallon capacity with steam coils, access stairs, and manway access. \$26,000. Please call for further details. 801-973-7912.(P01)

Vacuum tanks, 100 to 6000 gallons. All options available; hatches, primary, secondary, valves, catwalks, ladders, etc. Everything needed to build your own septic truck. Choose mild, stainless, or galvanized steel. Ask about full open doors. 800-545-0174. www.tanksandpumps.com. (PBM)

FOR SALE: 2 fiberglass tanks 14' x 35', approx. 35,000 gals. each, incl. most of the components for a sewage treatment plant to service up to 5000 pop. Produces class A biosolids. Located in Gibsons, B.C., Canada. Can be trucked or barged to new site. Price \$35,000 Can. 1-604-886-7064; 1-604-885-8101 cell. Kelly. (P12)

New 3400 gallon tank, never used, 20" manway bottom, 3" intake, 4" dump, hose trays. \$10,000. Delivery available. Other tanks available. 800-721-2774. (PBM)

TANK TRAILER

NEW Presvac 5500 gallon c/s, DOT certified vacuum tank unit, self-contained. **In stock!** (Stock #13325B) www.VacuumSalesInc.com, (888) VAC-UNIT (822-8648). (PBM)

TOOLS

T&T Tools: Probes, Hooks. Probes feature steel shafts with threaded and hardened tips. The insulated **Mighty Probe™** tested to 50,000 volts. **Top Poppers™** open manhole covers easily. Free catalog. www.TandTtools.com. Phone **800-521-6893**. (CPBM)

TOOLS

Crust Busters - Portable, light-weight machine guaranteed to mix up septic tanks and grease traps! Save time and money! www.crustbusters.com, 1-888-878-2296. (PBM)

TOYS

Septic pumper and vacuum die-cast toy trucks in your choice of colors and logos. Several cabs available. Call 877-450-2100 or write to Granite State Collectibles, PO Box 440, New Ipswich, NH 03071. (PBM)

TRAILERS VACUUM/TANKER

1993 Presvac 6,000 gallon DOT certified carbon steel vacuum trailer. Self-contained Deutz diesel engine with PV750 vacuum pump. Very good condition. \$38,500. KLM Companies 617-909-9044. (P10)

Absolute Public Auction surplus from Metropolitan Sewer of St. Louis on November 20th including vac-trucks, jetters, compost turner and other heavy equipment. www.jjkane.com. (CMPT111)

TV INSPECTION

1998 GMC extended van, raised roof, 1-ton, Aries mainline camera pan and tilt, Aries crawler. Crawler up to 24" pipe, 900' of video, down-hole equipment, computer and printer, VCR high profile light head for larger lines. We purchased as a demo unit, equipment in excellent condition, 98,000 miles. \$40,000. 1-877-282-4949. (CP10)

1993 Ford E350 box van, 7.3 diesel with Aries TV inspection, pan/tilt camera. Also have 2 extra tractors all on tracks, 1 stationary camera, and lots of extra parts, TV, VCR, rear air, diesel generator. Call or email and we will email pix, 573-374-8785, or elitemotors@charter.net. (CP11)

VACUUM LOADERS

2000 Sterling with Cusco Mastervac 3,800 CFM 3,000 gallon DOT certified vacuum loader. Wet/dry unit with full open rear door and Moro vacuum offloading pump. Low miles/hours. Ready for work. KLM Companies 617-909-9044. (P10)

VACUUM LOADERS

1999 International **heavy spec** with **Guzzler ace** wet/dry industrial vacuum loader. 8" top load boom truck is in excellent condition. Blower was reconditioned approximately one year ago. (Stock #7390V) www.VacuumSalesInc.com, (888) VAC-UNIT (822-8648). (PBM)

2009 Sterling LT9500 tri-axle with a new Presvac, **Powervac** 3800, 3,250 gallon US, DOT, wet/dry industrial, vacuum tank loader. (Stock #13336V) www.VacuumSalesInc.com, (888) VAC-UNIT (822-8648). (PBM)

1995 Clean Earth Vacuum Truck, 5500 cfm, 27" blower, wet & dry. Call for pricing and pictures. 1-734-942-9300. (CP10)

1992 International 9400 with Keith Huber 4000 gallon liquid vac, \$30,000. 1997 Ford with Guzzler Ace body, \$70,000. Financing available. Call 704-731-0025. (CP10)

1992 Ford with Guzzler 4816 with swing out Cyclone 6,000 CFM blower (4 yrs old). Cat engine with Fuller trans. 150,000 miles, 5,000 hours. Runs very good. \$25,500. KLM Companies 617-909-9044. (P10)

VANES

American Industrial Components: Our vanes are manufactured from the highest quality laminated materials available and are fabricated to exact tolerances and specifications. 800-272-7557. (PBM)

Dura Comp 535, high-quality non asbestos vacuum pump vanes. Good to 400°F. Buy factory direct and save. Same day shipment on most models. Jurop, Battioni, Moro, Masport, Fruitland, Demag. Long lasting Dura-Comp 535 pump vanes carry a "Money-back" guarantee. Call us today. Powerflo Products 800-758-4788 or 562-997-0720. (PBM)

WANTED

WANTED TO BUY: Stainless steel slide-in unit. Call Darrell @ 715-425-1025. (P11)

WANTED: Vacuum tank 2,300 gallon or 2500 gallon. Must be in good shape. Ph. 972-837-4848. (P11)

2005 - 2007 Used Freightliner/International. 26,000 GVW with steel 1100/400 or aluminum 1500/500. Automatic, air brakes, 40K or less. raymceachern@aol.com. Austin, TX. (P10)

WANTED: 12-yard debris tank for a Vactor PD unit. Call Kenneth @ 972-938-1905. (CPBM)

Water jetting equipment. We rent, sell and repair water blasters. Visit us at: www.waterjettingequipment.com or phone 714-259-7700. (CPBM)

WATERBLASTING

NLB 10-250 2000 model year with 1,200 hrs., 250 hp @ 43 gpm. Complete mounted on 1993 International truck with 120,000 miles. Fluid/power end just rebuilt by NLB. In good shape. \$42,500. KLM Companies, 617-909-9044. (P10)

2000 NLB 36201D, 1998 NLB 10200D, 1996 NLB 10200D, 1992 NLB 10150E, 1989 NLB 1012D, 2001 JetStream 4200D with 10k & 40k heads. Call for pricing and pictures 1-734-942-9300. (CP10)

Wanted to Buy: Vactor 2100s and late model Guzzlers. Cash. Phone 800-336-4369. (CPBM)

2003 NLB 10-150 electric waterblaster, (0) hours on unit - never used. Marathon Motor on skid. If you want brand new this is it. Priced to sell @ \$32,500. KLM Companies, 617-909-9044. (P10)

It's **EASY** to submit your classified **ONLINE!** Just go to:

www.pumper.com

Only
\$1.00
PER WORD

CLASSIFIEDS

Place A Classified Ad

Fill in the **Online Classified Ad Blank!**

BUY IT - SELL IT - PLACE IT - www.pumper.com - AVAILABLE ANYTIME, ANYWHERE, ANY DAY

Marketplace Advertising

PIT HOG PUMPS WASTE

LWT manufactures manned and remote controlled lagoon dredges and pumps. Rental dredges also available.



LWT LIQUID WASTE TECHNOLOGY

1750 Madison Ave., New Richmond, WI 54017
www.lwtpithog.com / 1-800-243-1406

T&T TOOLS **T&T Tools**
800-521-6893
800-521-3260 FAX
E-mail sales@tandttools.com • www.tandttools.com

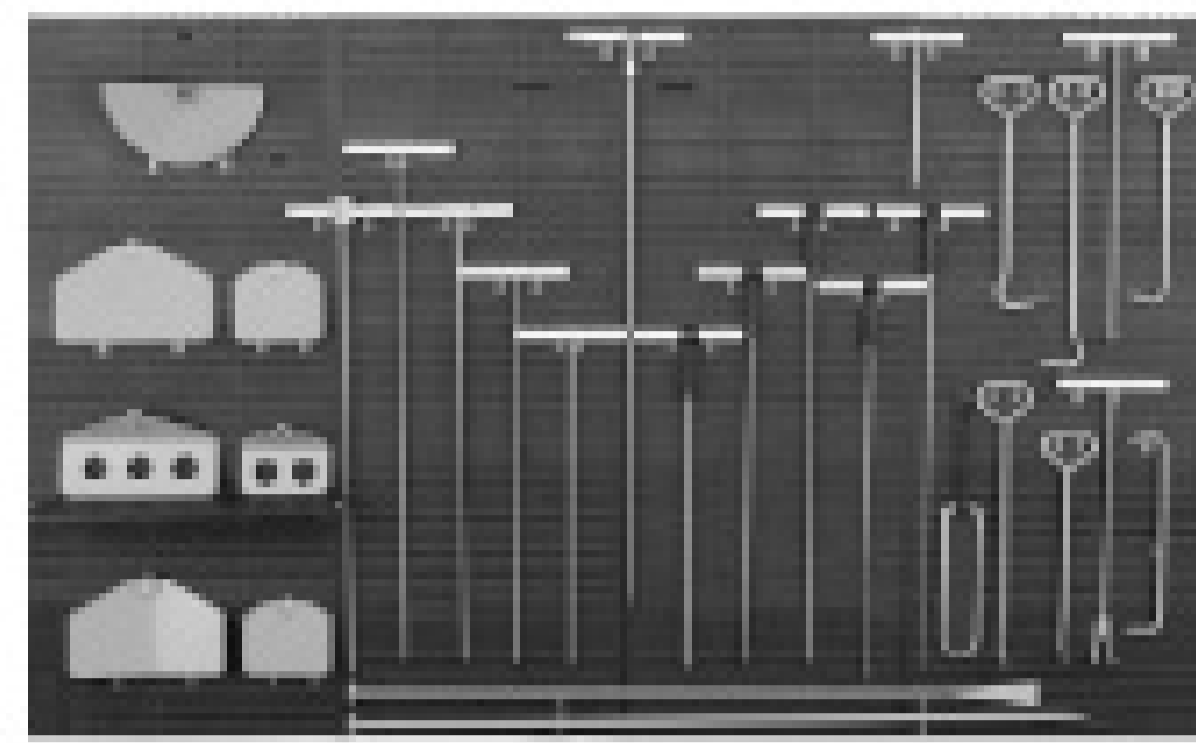

Mighty Probe™
Sludge Hoe™
(insulated)
Sludge Spud™
Manhole Hook™
Tommy Hook™
Striking Head™

Handy Hook™
Water Probe™
Curved Spud™
Top Popper™
Ground Buster™
Smart Stick™
(standard)

www.tandttools.com

Waterblaster Rentals

Houston, Texas



Boatman Industries

1K to 50K psi
60 hp to 1000 hp
Waterblasters & Accessories
Used Equipment Sales

713-641-6006
www.boatmanind.com

TrakMats®

Ground Cover Mats



- Stop Ruts, Damaged Lawns or Weather Delays.
- Stop Using Heavy, Wet, Rotten, Broken, Slippery Plywood
- Hand Cut-Outs for Lifting

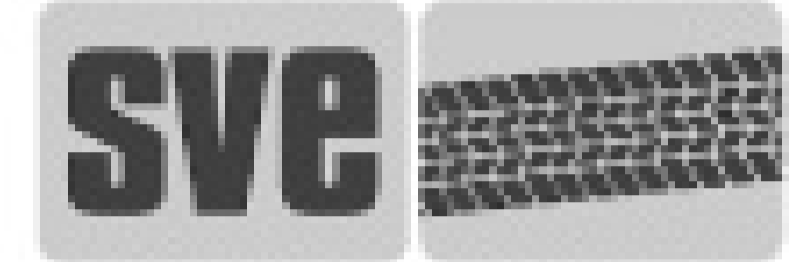

PORTABLE ROADWAY SYSTEMS, INC.

800.762.8267

www.trakmats.com sales@trakmats.com

Jetter Package

4.0 GPM 4000 PSI



\$1,499
Free Freight

Sewer Camera



\$1,095
Free Freight

Drain Snake



\$349
Free Freight

COMPLETE DETAILS AT
www.AmazingMachinery.com
1-800-504-7435

STOP!

DON'T ORDER ANY MORE BIOPRODUCTS
UNTIL YOU FIND OUT ABOUT BioOne®'s
REVOLUTIONARY TECHNOLOGY.

Drain Line, Grease Trap, Septic System Maintenance.

Profitable, Easy to Sell, Simple to Use.

There's nothing else like it.

Professional strength, EPA-recognized BioOne®.

CALL FOR A FREE SAMPLE



800-951-4246

One Biotechnology • www.1biotechnology.com

Large Wheel, Small Wheel, Tripod.

Three different types of lifts to cover all types of Septic Tank Covers. Plus, the "CUSTOM" Magnet for easy attachment.

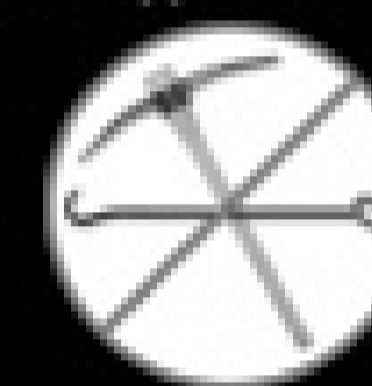

It's easy with
Bigs Easy Lift

See our updated web site,
lots of pictures and video!

We are interested in the safety of each & every worker

- Call, email or fax us your address for a FREE info pack (including DVD)
- Use the power of leverage, NOT your back...

Call today for a FREE Demo

phone: 866.926.5438

fax: 866.271.9057

email: info@BigsEasyLift.com

www.BigsEasyLift.com



Carry A Restroom On Your Pickup or Sport Utility



Hitch Hauler

DA Deal Assoc. Inc. www.dealassoc.com
866.599.3325

Aluminum Vacuum Tanks

ALUMATANK

progresstank.com

PORTAVAC

Septic & Restroom Service

What you learn on these pages could be worth **\$1,000s.**

It's all yours - **FREE.**

Join 25,000 of your peers who welcome Onsite Installer every month. Each issue shows new technology, tips on boosting machine performance, money-saving deals and much more.

FREE subscription at:

1.800.257.7222 OR

www.onsiteinstaller.com

Major Credit Cards Accepted!

\$35 PER DOZEN **\$189 FOR 6 DOZEN**

- 14" Gauntlet
- Plastic Coated
- Jersey Liner
- Sandpaper Finish Grip
- 1 Size Fits All

Make checks payable to: ADVANCE GLOVE CO.
Please include UPS shipping address.

ADVANCE GLOVE & SAFETY CO.
P.O. BOX 148 • LEHMAN, MI 48445
TOLL-FREE: **1.800.323.1223**

Kwik-Lokk

Vacuum Truck
Couplers and Hose.

www.kwik-lokk.com
(814) 899-3644

UDOR USA World Leader in Industrial Jetting Pumps



GKC Series Industrial Jetting Pumps
• 4.5 to 11.5 GPM
• Up to 5,000 PSI

Pento Series Industrial 5-Cylinder Jetting Pump
• 6.5 to 18 GPM
• Up to 6,000 PSI

Drive Options:
Gas Engine Drive
Electric Motor Drive
PTO Shaft Drive
Hydraulic Drive
Gear Reduction

UDOR USA
500 Apollo Drive Lino Lakes, MN 55014
Tel: 651-785-0666 Fax: 1-800-732-2670
www.udorusa.com • info@udorusa.com

CONFINED SPACE ENTRY PACKAGE ONLY \$3,195

The best package on the market includes:

- 4-Gas Air Monitor (3 Year Sensor Warranty)
- 7' Tripod
- 3-Way Fall Protection
- Work Winch
- Full Body Harness



Add a Blower with 15' of duct for only \$ 300!

Other Equipment Available

- Sewer Maintenance Tools
- Magnetic Lid Lifters
- Camera Systems
- Smoke & Dye Testing Items
- Blowers / Ventilators
- Vacuum Pumps and Acc.
- Aluminum Folding Ladders
- PPE
- High Pressure Water Jetters

MTECH 800.362.0240
www.mtechcompany.com

STARTRONICS SOLAR LIGHTING II, Inc.

RESTROOM LIGHTING SOLUTIONS

■ Low Cost
■ Easy Installation
■ Solar Charged
■ Low Maintenance

1-800-811-1985
www.startronics-solar.com

PADLOCKS

- Your Padlocks
- Your Key Number
- Any Quantity
- Best Prices

Quick-Shipped Anywhere!



Call For **FREE CATALOG** or **Instant Quote!**

LockMasters
1-800-461-0620
www.lockmastersusa.com
sales@lockmastersusa.com • Fax (850) 914-9754

Refrigerator MAGNETS

500 Minimum - Call for pricing



43¢ EACH!

Actual Size: 4-1/2" x 2"
1-800-758-2743
254-829-0373

2-color Imprint - Quantity Discounts

DYE TRACERS

Solutions for:

- Infiltration
- Septic Systems
- Cross Connection
- Leaks and more...



BRIGHT DYES
Division of Kingsco Chemicals

www.brightdyes.com • FAX: 937-886-9300

FREE SAMPLE 1-800-394-0678

Mobile Dewatering Service



Municipal & Industrial Sludge Digesters, Lagoons, Ponds, etc.

- Double Belt Filter Press
- Up to 25% Drier Cake
- Professionally Staffed
- US & Canada

Fluid Technology, Inc.
P.O. Box 937, Oxford, OH 45056
Phone: 513-981-7808
E-mail: sales@fluidtechinc.net
Web site: www.fluidtechinc.net

DISCOUNT ALUMINUM

SHEET, COIL, PLATE

3003/5052/5454/5083/5086 AND MORE

20 MILLION POUND INVENTORY

ARE YOU PAYING TOO MUCH?

1-888-540-0066
ASK FOR JAYSON

FAX: **440-286-2229**

E-MAIL: captaluminum@msn.com



ASHLAND PolyTraps

Grease, Oil, Hair and Lint Traps and Interceptors

- NO Rust or Corrosion
- Lightweight
- Very Cost Effective
- Sizes up to 560 Gallons
- Made in the U.S.A.!

LIFETIME WARRANTY!

Certified by U.P.C., IAPMO and P.D.I.

800-541-8004
PolyTraps@Amplex.net
www.ashlandpolytrap.com

PUMPER & CLEANER ENVIRONMENTAL EXPO INTERNATIONAL

Louisville '09
YOUR PLACE. YOUR TIME.

FEB. 25-28

WWW.ROOTERMAN.COM



Franchises available with low, flat fee
New concept. Call 1-800-700-8062.

FRANCHISE PACKAGE \$7,950.

No COMPROMISE



Don't accept a substitute for quality. The Burks DC-10 is still the most popular, high volume washdown pump available.

With flow rates to 20 gpm and pressure to 40 psig, the Burks DC-10 is the pump of choice for filling and washing your portables.

Contact your local tank manufacturer for more info, or call us toll-free at:

800-699-7557

**ARMSTRONG
EQUIPMENT
INC.**

11200 Greenstone Ave. • Santa Fe Springs, CA 90670

562-944-0404 • Fax: 562-944-3636

www.vacpump.com

Non-CDL
19,500 GVW to
66,000 GVW
Septic / Grease Trap
Portable Restroom
Vacuum Service



Complete
'Work Ready'
IN STOCK
Selection!

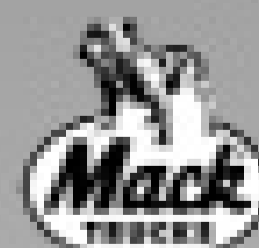
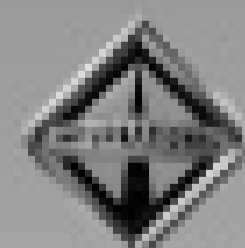

Contact: Mark C. Langworthy 800-261-9009

e-mail: mlangwor@tanktruckservice.com www.tanktruckservice.com

Tank Truck Service & Sales, Inc.

25150 Dequidre, Warren MI 48091

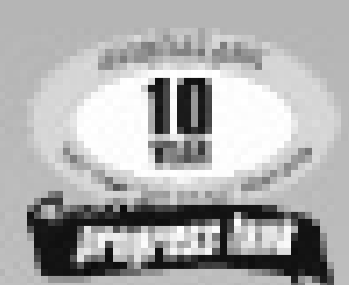

**Come In
We're**

OPEN 24/7

www.pumper.com

Pumper TRUCK STOP

see photos in COLOR at www.pumper.com



October



2000 GMC 6500: (under CDL) 207 hp, 6-spd. manual, 302,000 miles, new 1500 gallon carbon steel tank, new MEC 5000 Battioni 145 cfm vac. pump, automatic oiler.\$34,500

877-296-2555

P10



2002 GMC C7500: Cat 230 hp, 7-spd., air brakes, double frame, A/C, 125,000 miles, Abernethy 2500 gal. vacuum body, Masport HXL20 pump, 3,000 psi jetter w/90 gal. tank.

800-682-2216

P10



2004 Ford F550 Super Duty Diesel Pump Truck: White with gray interior, Best built with a 1050 gallon stainless steel tank, PTO driven Masport pump. Perfectly maintained by Gabrielli Ford in Jamaica, NY.....Wholesale Price of \$29,500

800-634-2085

P10



1995 Isuzu: Diesel, auto, with 2001 stainless steel tank, 200 fresh, 600 waste, hose reel, work light, 2 tool boxes, excellent condition, always shedded. Retiring.

.....\$20,000 OBO

320-746-2827

P10



2004 Freightliner/Vactor: Auto. trans, diesel engine 1300 gal. water, 80 gpm @ 2,000 psi system, Roots 824RCS 18" 3500 cfm blower, debris body flush-out, cold weather recirc., accumulator, multi-flow system, 8' hyd. telescoping boom, tele/rotating reel, unit loaded, low hours and miles.

Call Joe 312-208-6373

P10



1986 Chevy C65 Cat: Diesel 175K, 5-speed manual split shift. New brakes and tires. Pump-Meyers D-65, 2000 lbs @ 65 GPM. One hour on rebuild. Perkins diesel. 1000 gallon tank. Good hoses and nozzles. Ready to work.\$25,000 (a steal)

770-527-0376

(CPBM)



2002 Sterling: 470 hp Detroit, 10-spd., Jake, AC, cruise, 16 front, 40 rears, new 3500 gal. tank & Jurop R260-364 cfm vac pump. New paint and tires.\$62,500

877-898-5104

hullstruckbodies.com

P10



1993 International 4700: DT444 6-cylinder turbo, 6-spd. manual, new paint, only 189,556 miles, PS/AC, used 1999 1,800 gallon carbon steel tank and Moro vacuum pump.\$22,000

877-296-2555

P10



2004 5025 Supersucker: Mounted on a 2004 Sterling LT 9513 with Caterpillar C12 410 hp engine, as is, only 22,934 miles and 4457 blower hours.

.....\$155,000 or available for lease W.A.C. **205-664-2000 or 888-739-0838**

P10



1994 Vactor GMC White Cabover: Cummins 6 cylinder x2, 1,000 gallons, 5 yards, dual fans, excellent condition.

.....\$70,000 OBO

Contact Bill at 1-866-744-9921

(CP10)



1999 Volvo: 300 hp, 8-spd., exhaust brake, 3200 gallon Coleman stainless tank, skirting, decking and cabinets, 300 cfm Coleman pump.\$49,950

Judge Coleman @ 516-398-5638
cwjudge@aol.com

P10



2003 F-650: Cummins, 6-spd., AC, cruise, new 2000 gal. tank and Jurop PN84 vac pump, new paint, tires and alum. wheels.

.....\$38,500

877-898-5104

hullstruckbodies.com

P10



2005 Peterbilt 330: 300 Cat, 8LL trans., air ride cab & susp, approx. 50K miles, approx. 3000 US gal. Transway tank, heated rear discharge 6', stainless primary & secondary shutoffs, 100 gal. water tank, 350 cfm pump. Available Nov.Asking \$63,000 US

Call 519-856-0072 Evenings

P10



1985 International: 1700 series, 5-spd., diesel, 1800 gal. tank, Jurop pump (rebuilt Jan. 2008), 60' of hose. Truck is ready to pump, used daily.\$11,000

816-238-8500

NW Missouri

P10



1988 International: DT366 engine, 5-spd, under CDL, newer 2000 gal. tank and Jurop R260 vac pump. Really nice truck, ready to work.\$15,500

877-898-5104

hullstruckbodies.com

P10



2004 5025 Supersucker: Mounted on a 2004 Sterling LT 9513 with Caterpillar C12 410 hp engine, as is, only 12,312 miles and 3431 blower hours.

.....\$179,900 or available for lease W.A.C.

205-664-2000 or 888-739-0838

P10

Pumper

see photos in COLOR at www.pumper.com

TRUCK STOP



October



Shower and Restroom Trailers: Platinum and Gold Series, new and used available. Each with separate men and women sides.
CCI/Brian Touey 805-896-3777 PBM



2002 International 2554 w/Vactor 2110 Combo Sewer Cleaner: 275 hp, Allison AT, 80 gpm, 2500 psi pump, 10-yd. debris, hyd. rotating reel, deep tires & brakes, extremely clean, fully serviced & inspected, 33,803 miles, 5,573 hrs.\$102,500
Four Way Auto & Truck Sales
New Holland, PA - 717-354-3199 CP10



2001 Mack RD: E-Tech EM7-300 w/Jacobs engine brake, 7-spd. trans., 5:55 rears w/camelback susp., front lift axle w/duals, 227' WB, 4,000 gal. steel tank w/rebuilt Masport pump, 154,726 miles, 5400 hrs.\$68,000
Dave @ 610-285-2563
or dhummel@christmanseptic.com CMP10



1995 Guzzler Ramrodder: Totally refurbished by Vactor in Birmingham, Alabama July 2008. This vehicle is in mint condition and ready to work. Delivery service available.\$149,900 OBO
Sean or Tom 561-305-8687 CP10



2004 International 4300 DT 466: Air brakes, air conditioning, new 2150 gal. tank, new 400 Masport pump, liquid cooled, new tires on rear. ..Call for pricing
937-372-1113 P10



2004 Chevy C5500: Duramax, auto., AC w/Dyna-vac 900W/300F, dual side service, Masport, regularly serviced.....\$32,500
816-537-5623 or 816-304-0210
Ask for Warren or JR. P10



2000 International: Automatic transmission, DT series diesel engine, 2000 Vactor 2100. Loaded with options, ex-municipal unit.
Call Joe 312-208-6373 P10



1994 KW T-600: 300 hp Cummins, 180K, 2500 gal. tank, large storage compartments, tires 75%, 200 gal. fresh water tank, 6" heated dump valve, stainless steel hose trays, great truck!!.....\$36,000
320-269-2920 CFBM



Wells Cargo Elite II Restroom Trailer: Excellent condition, ready to rent to your customers. Must see to really appreciate. More picture available upon request. Located in Tennessee.\$18,000
Call Jerry @ 865-457-9918 P10



1986 GMC Conventional/1987 Aquatech B-10: Cat diesel engine, auto. trans., 12,000# front axles, 23,000# rear axles, 55,000 miles, Triplex rodder pump, Robuschi RB120 PD blower, front mount hose reel, hydraulic rear door locks.
Call Joe 312-208-6373 P10



For Purchase or Lease, NLB10225 DB Waterblaster: 10K & 20K, including new 500' of hose, 1 Barracuda nozzle, 2 shot guns, 1 splitter, various nozzles and lances.....Sale Price of \$91,000 Or lease purchase at \$2,669 per month, plus tax, for 39 months with a buyout of \$1.00 at end of lease W.A.C.
205-664-2000 or 888-739-0838 P10



1995 T-450 Kenworth: M11 Cummins, 10-spd., 540K miles, 3400 gal. tank, 367 Challenger pump, sea level gauge. Located in Missouri.\$29,500
Josh 816-365-6054 P10



1999 Vactor 2115/IH 2574 Chassis: Vactor 15-yd. body, 80 gpm @ 2500 psi pump, loaded with optional items. Chassis engine Navistar A300F, 300 hp, Eaton Fuller trans. (Stk.#0308C1P04)
Call Joe 312-208-6373 P10



1991 International 4900: 466 diesel, 275,000 miles, rebuilt by International at 100,000 miles, 10-spd. Fuller, 3750 Imperial tank, Battioni MEC 8000 (new in 2005), heated valves.\$30,000 OBO
218-666-2916 P10



2008 Ford F-550: Auto., 49,000 miles, 950 gallons waste, 300 gallons fresh water, like new, still under warranty.\$49,000
270-527-9945 P11



1991 GMC Tank: LT-10 Cummins engine, holds 18 cu. yds., newer motor w/31,010 miles. Needs new blower.....\$40,000 OBO
Please email:
shatal98@yahoo.com P12

Pumper

see photos in COLOR at www.pumper.com

TRUCK STOP



October



1984 International DT 466: Drop axle, 3,000 gallon vacuum tank, 200 gallon fresh water, 230,000 miles. Runs good; used daily.Asking \$18,000
717-369-4809 P10



1975 Chevy: 366 V8 engine, 10-wheeler, Model 175B Calweld drill/bucket rig, triple Kelly capable of 90 drill depth, 42 ring gear capable of drilling 8' diameter.\$50,000
Paul 909-721-2608 P10



1992 Ford L8000: 7.8L diesel, 10-spd., 1900 waste, 200 fresh, 382,000 miles. Truck runs good and works good,\$18,000
601-573-7873 P10



1991 White-Volvo with 1995 Keith Huber Berringer II: 1600 cfm, 3300 gal. tank, good condition, ready to work. Regular PMs. Great looking truck.\$80,000 OBO
214-391-1109 P12



2000 Sterling, Vac-Con V311: 3126 Cat, Cummins 3.9 turbo upper, Allison auto., 20 front, 40 rears, 23,470 miles, 3,309 hours vac unit, 611 hours on jetter.
814-696-4343 - Hollidaysburg, PA QV/P10



2000 Peterbilt 330: Cat 3126 250 hp, Allison MD 3060 auto. trans., new 2500 carbon steel tank, baffles, alum. diamond plate trays, fresh red accents w/red bed liner on tank, 3" inlet, 4" outlet, NVE 367 pump pkg.
352-323-6284 X 201 P10



1995 Ford L8000 Vac-Con: Brand new blower (not rebuilt) 0 hrs., 60 gpm @ 2000 psi, new intake components, new front tires, rear 90%, reworked fuel pump, fresh paint, AM/FM, CD radio, clean inside, 59,000 miles, well taken care of.....\$62,000 OBO
Tony 508-304-4102 P10



Will Be Sold at Ritchie Bros. Auction in Las Vegas Nov. 7th: (3) well equipped, low mileage trucks; '92, '94 4900 Intl. and '85 4x4 Intl.
801-798-0626
More info:
www.pumpersale.blogspot.com
and www.rbauuction.com P10



2006 Sterling 2100 Jet Rodder with Hydroexcavation Package: PD blower, 80/100 gpm, high dump, excellent condition.
866-922-2626 CP10



1983 Ford F-8000: 3208 Cat engine, 5-spd. trans., air brakes, 2000 gallon vac tank. Pump recently rebuilt.\$7,000
912-427-1319 P10



1995 International: Int. 530 motor rebuilt 12-2005, 3500 gallon tank with new paint job, Masport water-cooled vacuum pump, tires 70%, 192,000 miles. One owner, garage kept. Ready for work.
610-797-0630 CP12



2002 International DT466: 4300 auto, air brakes, 217K, Wallenstein pump-rebuilt 4/08, steel tank, 1000 waste/400 fresh.\$15,000
330-351-4353 or patflynn2@aol.com P10



1986 SRECO Jetter: Auto trans., Meyers pump, 2000 psi, 65 gpm, 300' of 1" hose with Warthog nozzle.\$8,975
978-476-1543 P10C11



2001 Mack CL713: 350 hp E7 Mack, AC, cruise, 8LL trans., air suspension, 187,000 actual miles, tires 80%, 6000 gallon aluminum tank w/3 baffles, NVE 506 Challenger pump.\$94,000
479-619-8226 P11



2007 Freightliner M2 Business Class: 19,000 miles, new 3500 gal. vacuum unit, Masport 400 cfm liquid-cooled vacuum pump, 24x24x60 aluminum toolbox.
Call 734-777-0390 P10



1998 International: Diesel 4700 series, 2500 gal. tank, transmission 6+1, vacuum pump new, 151,000 miles.\$36,000
Call John 248-437-0841 P10



Classy Truck of the Month

Advantage Septic & Drain
Upsala, Minn.

One Complete Package

promonthly.com

cleaner.com

pumper.com

mswmag.com

onsiteinstaller.com

pumpershow.com

pumpertrader.com

eq-mag.com

septicyellowpages.com

sewerpages.com

COLE Publishing

1.800.257.7222 | 715.546.3346

This large-load 1998 Freightliner FLD 112 carrier with 4,000-gallon steel tank gives a big boost in efficiency to owner Steve Lojovich, enabling him to empty three tanks before making a disposal run. Lojovich purchased the cab and chassis from Farwest Equipment in Mount Vernon, Wash., in 2005 and drove it back to Minnesota for conversion. Peterson Blacksmith shortened and doubled the frame, moved the stack and added a pusher axle. Engle Fabrication Inc., Sauk Centre, Minn., built the tank, placed it on the truck and made hose trays, rear lime slurry vats and intake, installed heated 4-inch intake and 6-inch heated air-activated brass valves. The hose trays and truck and tank underside are sprayed with chip guard. Graphics were designed by Lisa Lojovich and executed by Froggy's Signs and Graphics. The truck is powered by a 370-hp Cummins M11 and a 10-speed Eaton-Fuller transmission with differential lock. The tank has a 36-inch manway and a Masport HXL 400 WV liquid-cooled pump so Lojovich can pump 200 feet to stay off lawns. The truck has aluminum side boxes for hauling lime and tools and a large aluminum box behind the cab with an electrical winch hoist for use with a General Pipe Cleaners sewer roter and pressure washer.

Show us yours!

Got a truck with real WOW appeal? Show it off to Pumper readers — and to the whole world through www.pumper.com!

Send photos of your truck after it has been lettered with your company name, and please pose the owner(s) with the truck. Any industry-related truck is acceptable. Please limit your submission to one truck only.

Your submission must include your name, company name, mailing address, phone number, and details about the truck, including tank size, cab/chassis information, pump information, the company that built the truck, and any other details you consider important. In particular, tell us what features of the truck help make your work life more efficient and more profitable. E-mail your materials to editor@pumper.com or mail to Editor, Pumper, P.O. Box 220, Three Lakes WI 54562. We look forward to hearing from you!



Cost of fuel & disposal dulling your bottom line?

Brighten it up with a cost savings

Belt Filter Press

From Bright Technologies

BRIGHT
TECHNOLOGIES

**GREASE TRAP WASTE
INDUSTRIAL WASTE
MUNICIPAL WASTE**

Made in the USA

800-253-0532 Toll Free USA
269-793-7183 Phone 269-793-4022 Fax

www.brightbeltpress.com

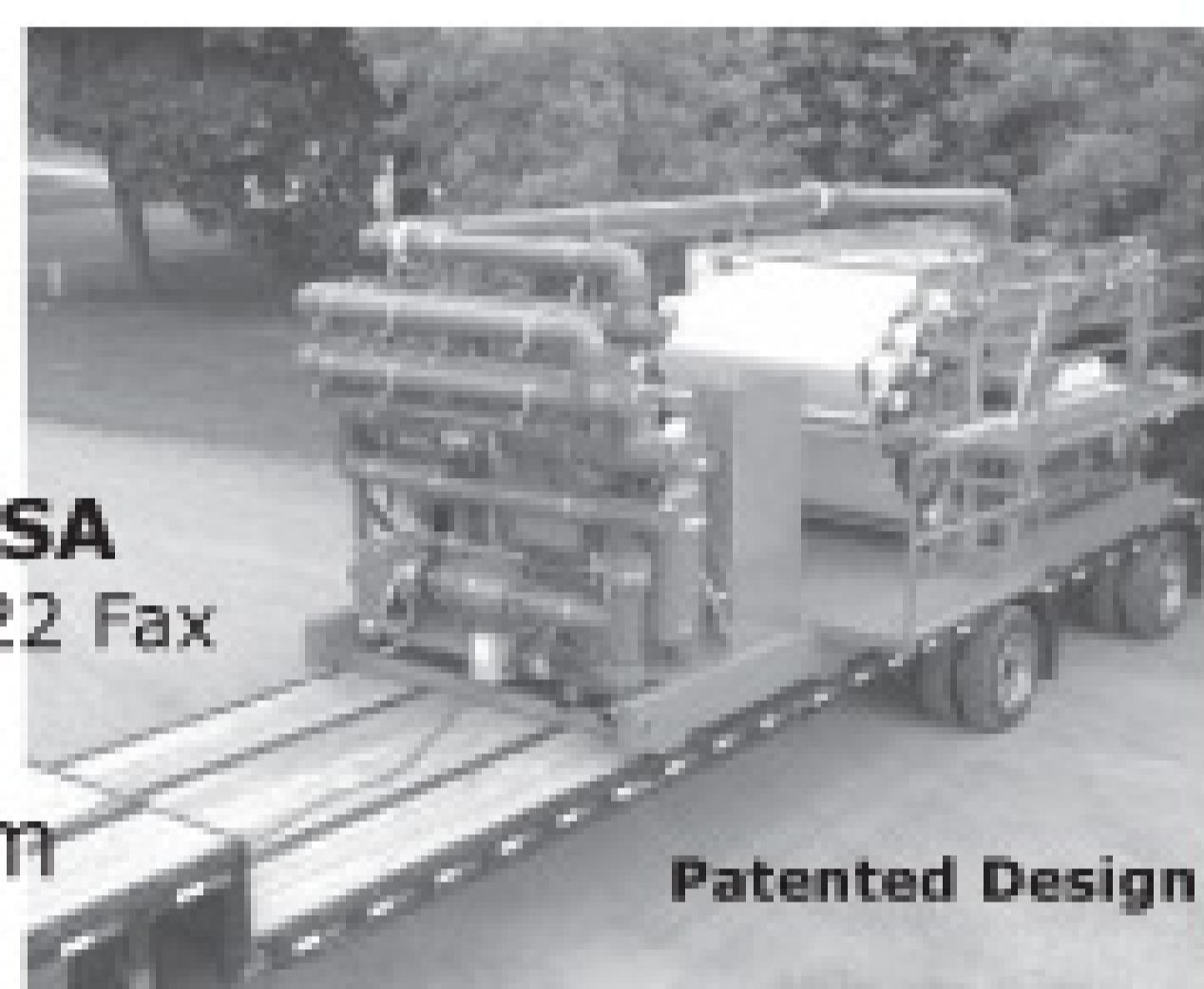

Patented Design

ART'S
TRUCKS & EQUIPMENT

View Our Entire Inventory
Online: www.artstrucks.com

3001 West Expressway 83
McAllen, Texas 78503
956.686.2326 Fax 956.686.5179

1.800.292.7007

www.artstrucks.com



1999 VOLVO Combo Sewer Truck
VOLVO-275HP Diesel Engine, Allison 3560
Automatic Trans., A/B, A/C, 55,604 Miles,
Vac-con Sewer Cleaner, John Deere Rear
Diesel Eng., Lot #2815680 - \$75,500

**2000 FORD STERLING Sewer
Truck** CAT 3126-300 HP Diesel En-
gine, Allison Automatic Transmission,
Air Brakes, 98,636 Miles, A/C, Safejet
Vac Sewer Cleaner, Lot #2815597 -
\$79,500



**1992 INTERNATIONAL Combo Sewer
Cleaner Truck** CUMMINS Diesel Engine,
Allison Automatic Transmission, A/B,
VAC-CON V390THA, John Deere Rear
Diesel Engine, Lot #2715400 - \$39,500



Portable Toilet Trailer 19FT Length,
Tandem Axle, Four Tires, Pintle Hitch
Trailer, Lot #2714939 - \$1,900

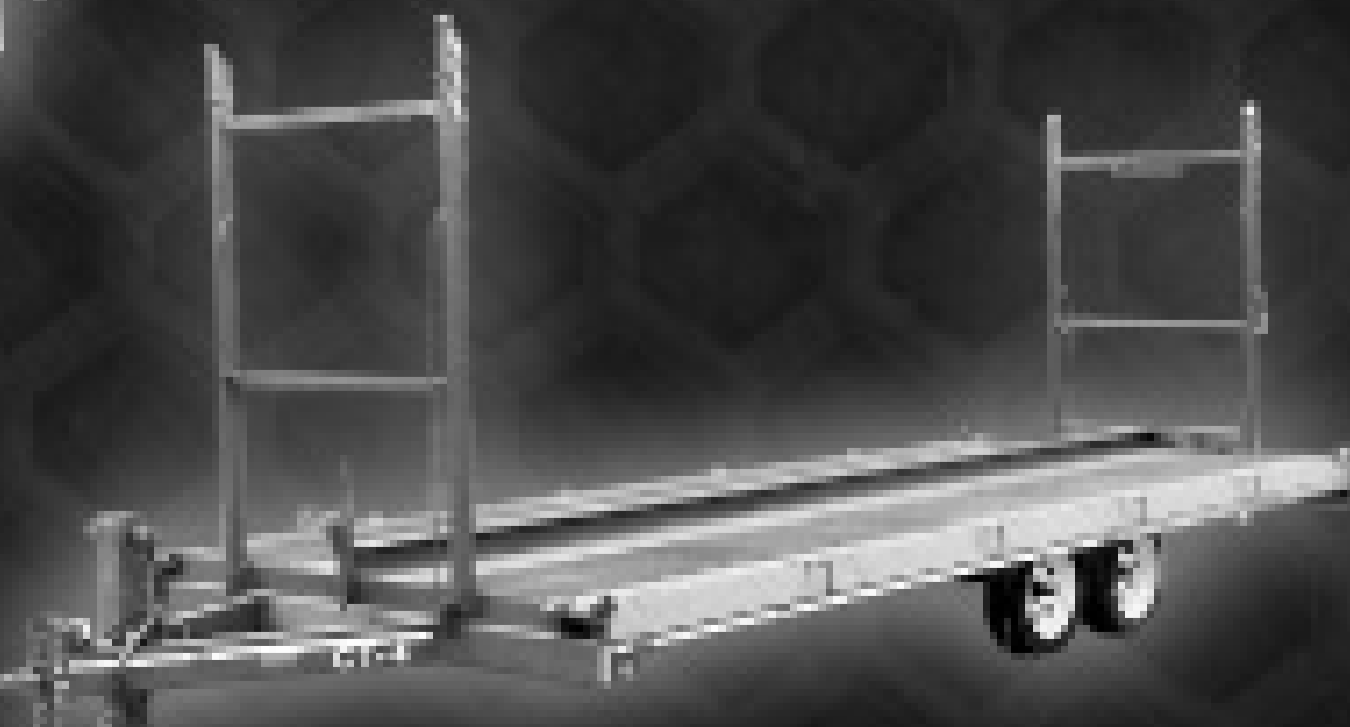

Get More Income with Every Tank Pumped!

With

PRO-PUMP®

The Finest Name in Biological Products for Septic Systems,
System Recovery, Odor Elimination and More...

Introducing New PRO-PUMP®/SEPTIC SAVER!



**SEPTIC
SAVER**

PRO-PUMP®/SEPTIC SAVER is a combo pack of our two best selling septic treatments: PRO-PUMP®/HC & SP packets, bundle packed as a monthly (12) treatment program.

- Septic System Treatment
- Absorption System Recovery
- Aerobic System Treatment
- Drain & Grease Traps
- Solids Reduction
- Odor Control
- Bio-remediation

**The Best
Microbial
Technology
Available
Today!**

The PRO-PUMP® biological series is designed to meet a wide range of on-site wastewater applications with unmatched performance!

**Want to earn more income per truck per year?
BECOME A PRO-PUMP® DISTRIBUTOR!**

**Professional Sales Materials &
Technical Support at No Charge!**

We provide technical support, combined with informative sales and marketing materials, and we don't sell direct to the consumer! All web-based inquiries are sent to you!



Solving Problems, Naturally!

Ecological Laboratories INC.

CORPORATE OFFICES: 13 Hendrickson Ave., Lynbrook, NY 11563

TOLL FREE: 1-800-326-7867 • FAX: 516-823-3440 • EMAIL: info@propump.com

Visit our web site at: www.propump.com

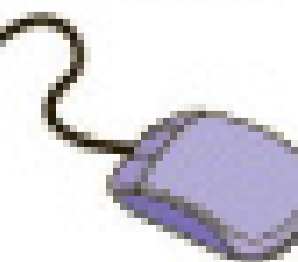



Technologies

Polylok, Inc. is proud of its commitment to the environment and to the onsite wastewater industry. We have been providing filtration products since 1959! Choose from any of our 3 great technologies to meet all of your residential and commercial needs:

- 1 Polylok uses a Screen technology to prevent solids larger than 1/16" or 1/32" from exiting the tank.
- 2 Zabel offers a Disc Dam technology that allows for settling in the tank.
- 3 Best uses Conical Shaped Plates to allow solids to slough off.

Many of our filters offer our patented shut off ball. All of our filters accept Smart Alarm™ to notify the owner when the filter requires servicing. And unlike our competitor's, there is no wrong way to install our filters, so bypass is never a problem!



Innovations in Precast, Drainage & Wastewater Products



3 Fairfield Blvd, Wallingford, Connecticut 06492

1-800-701-3942



For a Free catalog or to see other products call or visit our website: www.polylok.com

Tough Products & Knowledgeable People
ALWAYS IN YOUR CORNER

SaniStand™
Hand Sanitizing Station

BRAVO!®
Self-Contained Sink

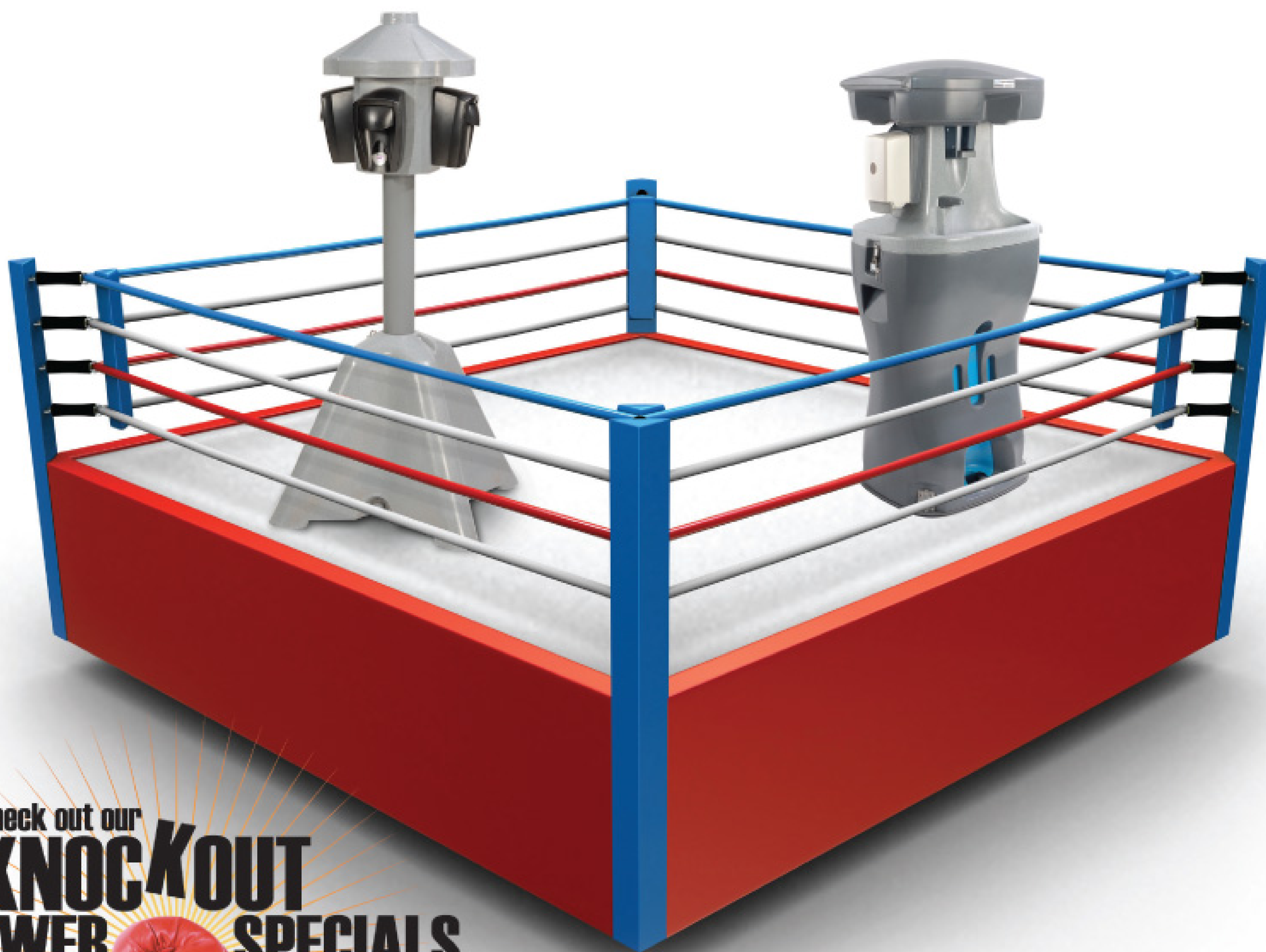

Check out our
**KNOCKOUT
WEB
SPECIALS**



there when you need us

800-292-1305

www.polyjohn.com

Go to www.polyjohn.com and
check out our seasonal promotions.

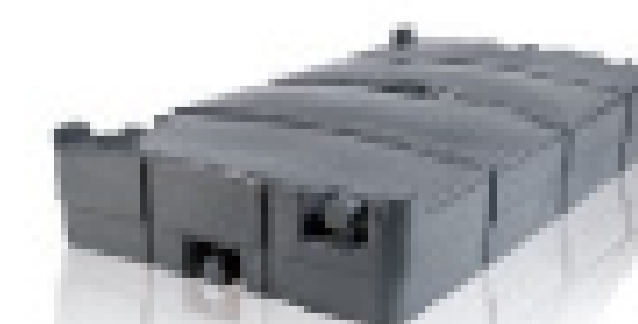
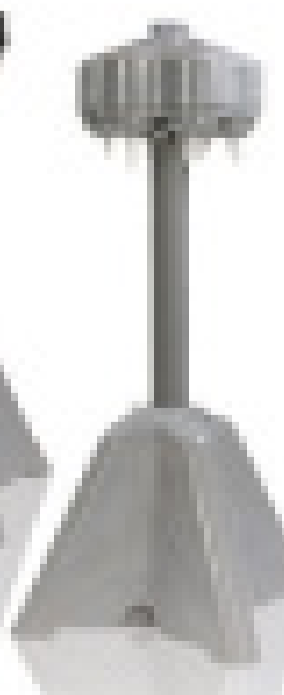
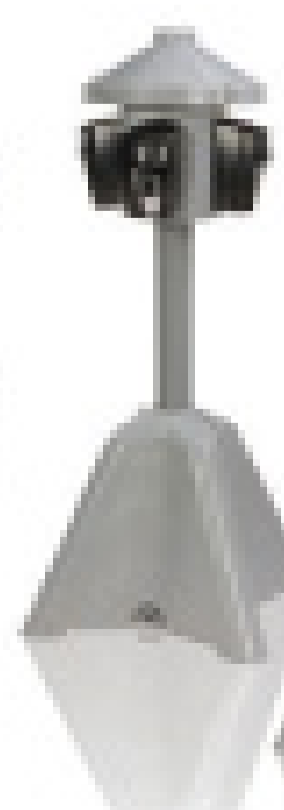

EARN MORE • SELL MORE • SERVICE BETTER

PRESVAC

**The Leader
In Vacuum
Technology**

Bright finish Aluminum Tanks
for the Septic Pumping
Industry... Standard
tank models from
2,000 gallons
to 5,000 gallons.



Hydro-Trencher - 5300 CFM air flow/28" HG vacuum
with 8" hydraulic actuated boom, 3000 U.S. gal.
debris tank (stain. steel 316), 1000 U.S. gal.
water tank (stain. steel 316), 9 G.P.M. water
pump with pressures to 5800 p.s.i.

Powervac 5300 for wet/dry operation

5300 CFM air flow/28" HG vacuum, Dump chutes
extended to rear of truck, Stainless steel 316,
DOT 407/412



Liquid Truck

Designed for industrial liquid applications

www.presvac.com

Nationwide Sales & Service
Call a Presvac Dealer in Your Area!

4131 Morris Drive • Burlington, Ontario, Canada L7L 5L5 • Fax: 905-681-0411

905-637-2353 • 800-387-7763