

DEWATERING & PRETREATMENT • LAND APPLICATION

DEDICATED TO THE LIQUID WASTE INDUSTRY

Pumper

June 2008 www.pumper.com \$5.00 U.S.



No Separation Anxiety

Can-do Idaho pumpers solve a disposal dilemma

PAGE 44

**GREEN
& Growing**

Eco-friendly theme pushes
Bluewater Septic expansion

PAGE 30

WE SELL NATIONWIDE, BUT WE DO BUSINESS LOCALLY



3600 Kenworth \$103,602



2500 Peterbilt \$85,965

USED SEPTIC

2001 Peterbilt

W/Steel Tank
\$62,500



2006 International

W/Steel Tank
\$67,000



P & D

Aluminum Tank
800 Gallons
\$68,595



NEW RESTROOM

950
starting at
\$54,793



1250
starting at
\$65,743



1600
starting at
\$70,993



2000
starting at
\$77,895



QUOTES OR QUESTIONS? CALL:

800-328-3332

Masport®

Quality Vacuum Pumps and Components

**This Summer, Get Ahead of the Competition
with a *Masport Plug & Play System!***



HXL4V Air Cooled Plug & Play

- 160 CFM • 20" Hg CONTINUOUS
- **THE LEADER IN PORTA-POTTY PUMPS**



HXL400WV Liquid Cooled Plug & Play

- 400 CFM • 25" Hg CONTINUOUS
- **LIQUID COOLED FOR HEAT STABILITY**

Engineered to Out-Perform, Built to Out-Last!

Also available are Robushci High Vacuum Blower Systems (494 - 1602 CFM; 27" Hg Continuous)

Vacuum Pump Oil

Try these quality Masport products during the summer months:



Vane Pump Flushing Kit



Pumper/Scent Kits



FOR MORE INFORMATION CALL: 1(800) 228-4510

www.masportpump.com



Sanitation Station
"Commercial Quality"
Running Water Restroom
DropBox

No out of pocket expense
Immediate revenue generation
New product to your rental fleet without a major investment

Three business model offers with the Sanitation Station are:

OPTION 1
 • You buy it!
 • You rent it!
 • You pump it!

OPTION 2
 • You have a six month minimum rental...
 • We rent the unit to you at a discounted rental rate...
 • You mark the unit up and re-rent it to your customer...
 • You enjoy the revenue from pumping the unit...

OPTION 3
 • You have a six month minimum rental...
 • Call DropBox and we land the business for you...
 • We rent the unit to your customer...
 • You enjoy the revenue from pumping the unit...

DROP BOX

1.888.388.7768
www.dropboxinc.com



Working well under pressure!

CAM SPRAY

GET MORE JETTER FOR YOUR DOLLAR!



STB2511H-MAX

Full Featured Jets with Powered Reels:
SK4007V 23 h.p. Briggs 7GPM @ 4000 PSI... \$9950
STB2511H 24 h.p. Honda 11 GPM @ 2500 PSI... \$11699
SK3012K 29 h.p. Fuel Injected Kawasaki 12 GPM @ 3000 PSI... \$13995
STB2020V 35 h.p. Briggs 20 GPM @ 2000 PSI ... \$19699
STB4018DT 49 h.p. Hatz Quiet Diesel 18 GPM @ 4000 PSI... \$39950

Trailer Models starting at \$7499

www.camspray.com **800-648-5011**

Reading Between the Lines

Bergh Rushes to Defend the Industry

By Jim Kneiszel, Editor



Bad news, as someone once said, travels fast. And wildly inaccurate information about septic system mishaps travels lightning fast. Bill Bergh can attest to that after overhearing a water cooler discussion this spring at his office.

Bergh, owner of Geotech Soil & Site Evaluation in Chippewa Falls, Wis., had just opened the morning paper to find a story about a local man who fell into a septic tank and drowned. The elderly man apparently removed the tank lid and was in the process of diagnosing a problem when he fell in, headfirst.

In the story, (retold in our *Association News* column this month) a volunteer firefighter at the scene pulled some numbers out of the air, telling a reporter that eight to 12 people die in septic tanks in Wisconsin every year.

It seemed like an outlandish death toll to Bergh, and he wasn't alone. Soon his phone was ringing as fellow members of the Wisconsin Onsite Water Recycling Association called to complain about the story that ran in the local newspaper and was spread across the state by The Associated Press.

Bergh walked up to the drinking fountain at the office he shares with another business, just as a group of workers were gathered. "I had no idea septic systems were so dangerous," one remarked about the news account. They all nodded. Bergh was upset that his industry's image was being unfairly tarnished.

"You know what happens when there's misinformation out there. It's pretty much gospel and there's not much you can do to retract it," Bergh recalled. "People tend to remember the bad stuff. That's with anything, not just our industry."

A member of the WOWRA board of directors, Bergh was determined to do what he could to get accurate information in the public's hands. The trade group looked for statistics on deaths involving septic tanks, and could find just one incident in the state in more than a decade. Bergh set up an interview with the local Eau Claire Leader-Telegram — which printed the original story — and set the record straight.

HIRE A PROFESSIONAL

"A writer called and spent 15 minutes with me, then published an article the next day pointing out that septic tank deaths are a rarity," Bergh said. "I think he was trying to get the right information out there."

Bergh and WOWRA should be applauded for quickly countering misconceptions about the safety of septic systems. But a bigger issue than a tarnished image, according to Bergh, is that more pumpers and onsite installers should be promoting maintenance contracts.

"There's no good reason for anyone who's not licensed by the state of Wisconsin and working in this industry to be entering a septic tank. None whatsoever," Bergh said. It saddened Bergh to say that the elderly man might be alive today if he'd called a professional and spent \$100 to take care of a problem.

"There's still a lot of people who want to fix it themselves," he said. "I liken this to the guys who still go up on the roof to clean out their gutters, and somebody always falls off and dies."

Bergh hopes more homeowners get their systems checked regularly and that pumpers do what they can to make sure tank lids are secured to reduce the odds of this situation being repeated.

"I encourage people to call me, even for the smallest things. Call me if you think something's not right," he said. "Just call me." ■

Contact us: Pumper strives to serve the liquid waste industry with interesting and helpful stories. We welcome your comments, questions and column suggestions and promise a prompt reply to all reader contacts. Call 800/257-7222; fax 715/546-3786; e-mail Pumper editor Jim Kneiszel at editor@pumper.com.

HOUSE OF IMPORTS **TRUCK SALES**

▶▶ SINCE 1947

CALL ANGEL AT:
786.258.3384
OR
305.691.4778

▶▶ WWW.HOUSE-OF-IMPORTS.COM

CUSTOMER TESTIMONIALS

"Angel — We'd like to thank you for our recent purchase of our 4000 gallon pump truck. The truck is beautiful, we have received nothing but compliments! The performance is outstanding. This truck has made the perfect addition to our fleet. We are looking forward to doing future business together."

— **Best Regards, Andrea Muzzupappa, A-Able Septic**



2002 FREIGHTLINER

3600 GAL. - AVAILABLE IMMEDIATELY



2000 INTERNATIONAL

3400 GAL. - AVAILABLE IMMEDIATELY



1999 STERLING

2500 GAL. - 350 HP CUMMINS, 9 SPD

**AVAILABLE
IMMEDIATELY**



2004 PETERBILT 379

THANK YOU AGAIN TO JOHN - 4TH PURCHASE!



2002 PETERBILT 385

THANK YOU TO BRIAN

100,000 MILE LIMITED FACTORY WARRANTY

▶ DELIVERY ▶ EXPORT ▶ PUMP WARRANTY: 1 YEAR ▶ TANK WARRANTY: 5 YEARS



ARTICLES

30 Green & Growing - Ken Wysocky

On the cover: For New England contractor Bluewater Septic, environmentally friendly processes point the way to business expansion. On the cover, Bluewater technician Paul Martin rewinds a hose after pumping a septic system using a Labrie Environmental Group Juggler truck. (Photo by Jennifer Longley)

4 Reading Between the Lines: Bergh Rushes to Defend the Industry

When an onsite system designer hears outlandish fatality figures associated with septic systems, he jumps in to set the record straight with the local media.

- Jim Kneiszel

14 Building the Business: Growing Leaders Takes Time

Look for workers with great potential to advance the business, then invest in their development.

- Gary Bradt

22 Rules and Regs: Wisconsin Tightens Maintenance Rules and Raises Sanitary Permit Fees

- Scottie Dayton

44 No Separation Anxiety

Hands-on Clearwater Tech owners build their own custom dewatering solution offering simplicity and significant disposal cost savings.

- Scottie Dayton

54 Losing the Super Bowl

Claiming trademark infringement, the NFL forced a Phoenix portable restroom operator to change its name on the eve of the big game.

- Robert E. Carlson

72 Overheard Online: Clogged Arteries

A poster wonders if he can clean out sluggish drainfield lines without the major surgery of replacing the onsite system.

REGULAR FEATURES

62 Money Manager: Spit & Polish

From the back room to the books, you need to dress up your business to get the best price when it's time to sell.

- Fred S. Steingold

80 Reader Pipelines: The Big Squeeze

Pumpers seek creative solutions when governments impose ever-tighter requirements for waste disposal.

- Mary Shafer

96 Septic System Answer Man: Lengthwise

When you anticipate higher sewage flows, go long, not wide, with the mound system seepage bed design.

- Roger E. Machmeier, Ph.D

102 NAWT News: NAWT Waste Treatment Symposium Set For Missouri

- Tom Ferrero

104 Classy Truck of the Month

We feature Aardvark Waste Services, Hurricane, Utah.

110 Product News: Spotlight — High Tech II Deluxe Flush Restroom

- Ken Wysocky

116 Industry News

124 Association News; Training and Education; Calendar

Coming in July

Special Issue: Portable Sanitation/Special Events

- Pumper Interview: Serving the red carpet crowd
- Contractor Profile: 60-year-old company keeps restrooms fresh

Pumper

DEDICATED TO THE LIQUID WASTE INDUSTRY

www.pumper.com

Published monthly by
COLE Publishing Inc.
1720 Maple Lake Dam Rd.
PO Box 220
Three Lakes WI 54562

© Copyright 2008 COLE Publishing Inc.
No part may be reproduced without
permission of the publisher

In U.S. or Canada call toll-free 800-257-7222
Elsewhere call 715-546-3346
E-mail: info@pumper.com
Web site: <http://www.pumper.com>
Fax: 715-546-3786

Office hours 7:30 a.m. - 5:00 p.m.
Central Time, Monday - Friday

SUBSCRIPTION INFORMATION: A one year (12 issue) subscription to *Pumper* in the contiguous 48 U.S. states costs \$16 (24 issues for \$26; 36 issues for \$36). Subscriptions to Canada or Mexico cost \$28 per year (24 issues for \$54). Subscriptions to all other foreign countries cost \$82 per year. Subscribers are guaranteed monthly delivery of the magazine. To subscribe, send company name, mailing address, phone number and check or money order (U.S. funds payable to COLE Publishing Inc.) to the address above. MasterCard, VISA and Discover are also accepted. Supply credit card information with your subscription order.

CLASSIFIED ADVERTISING: RATE: \$1.00 per word, per month. Minimum of 20 words or \$20. All classified advertising must be PAID IN ADVANCE. **DEADLINE:** Classifieds must be received by the first of the month for insertion in the next month's edition. **PHONE-IN ADS ARE NOT ACCEPTED.** Ads may be faxed only when charging to MasterCard, VISA or Discover. Please supply all credit card information with faxed ads. Be sure to include your phone number (with area code) in your ad. Make checks payable to COLE Publishing Inc. and mail with classified ad to the address above. **CLASSIFIED ADVERTISING APPEARS NATIONWIDE AND ON THE INTERNET.** Not responsible for errors beyond first insertion.

DISPLAY ADVERTISING: Call 800-994-7990 and ask for Jeff, Jim, Kim or Winnie. Publisher reserves the right to reject advertising, which in its opinion is misleading, unfair or incompatible with the character of the publication.

CIRCULATION: Circulation averages 24,493 copies per month. This figure includes all three circulation regions (nationwide) and international distribution.

2009 PUMPER & CLEANER ENVIRONMENTAL EXPO INTERNATIONAL



Education Day:
February 25, 2009

Exhibits Open:
February 26-28, 2009

Kentucky Exposition Center
Louisville, Kentucky

www.pumpershow.com



MORO PUMPS

"Over 50 years of service and here to stay!"

Ask for a quality Moro pump from your truck builder, or call us for the dealer nearest you.

Pittsburgh, PA . 1-800-383-6304 . fax 412-269-4172 . www.morousaeast.com . moroeast@attglobal.net
St. Louis, MO . 1-866-383-6304, 636.584.8844 . fax 636-583-2044 . www.morousaeast.com . moro@charter.net

Isn't it time to UPGRADE to a MORO?

Complete Right Angle Packages

Completely Assembled

Pumps available from 176-1642 cfm

M3
176 cfm



M10
230 cfm



PM80 350 cfm

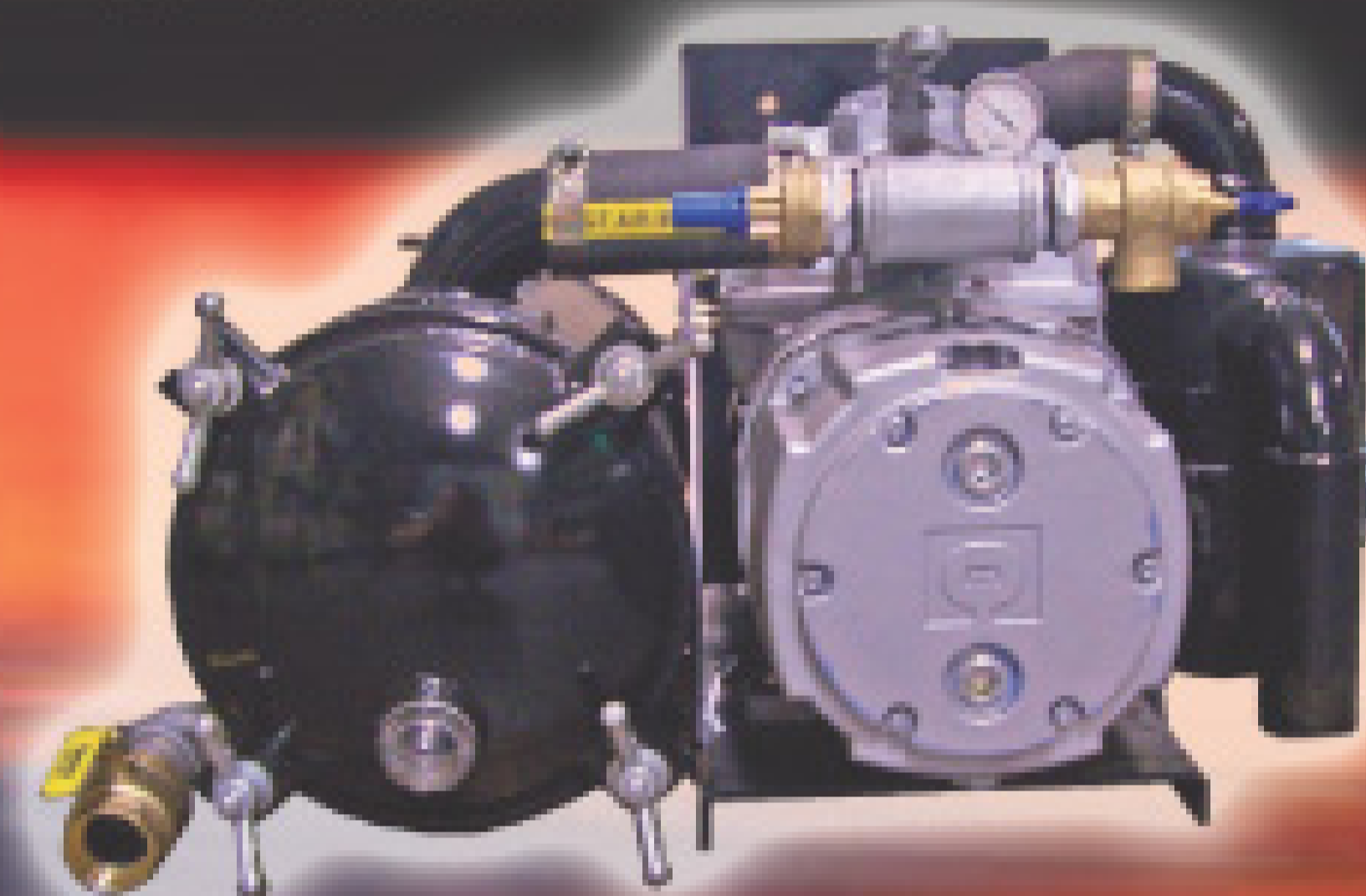

PM100
460 cfm

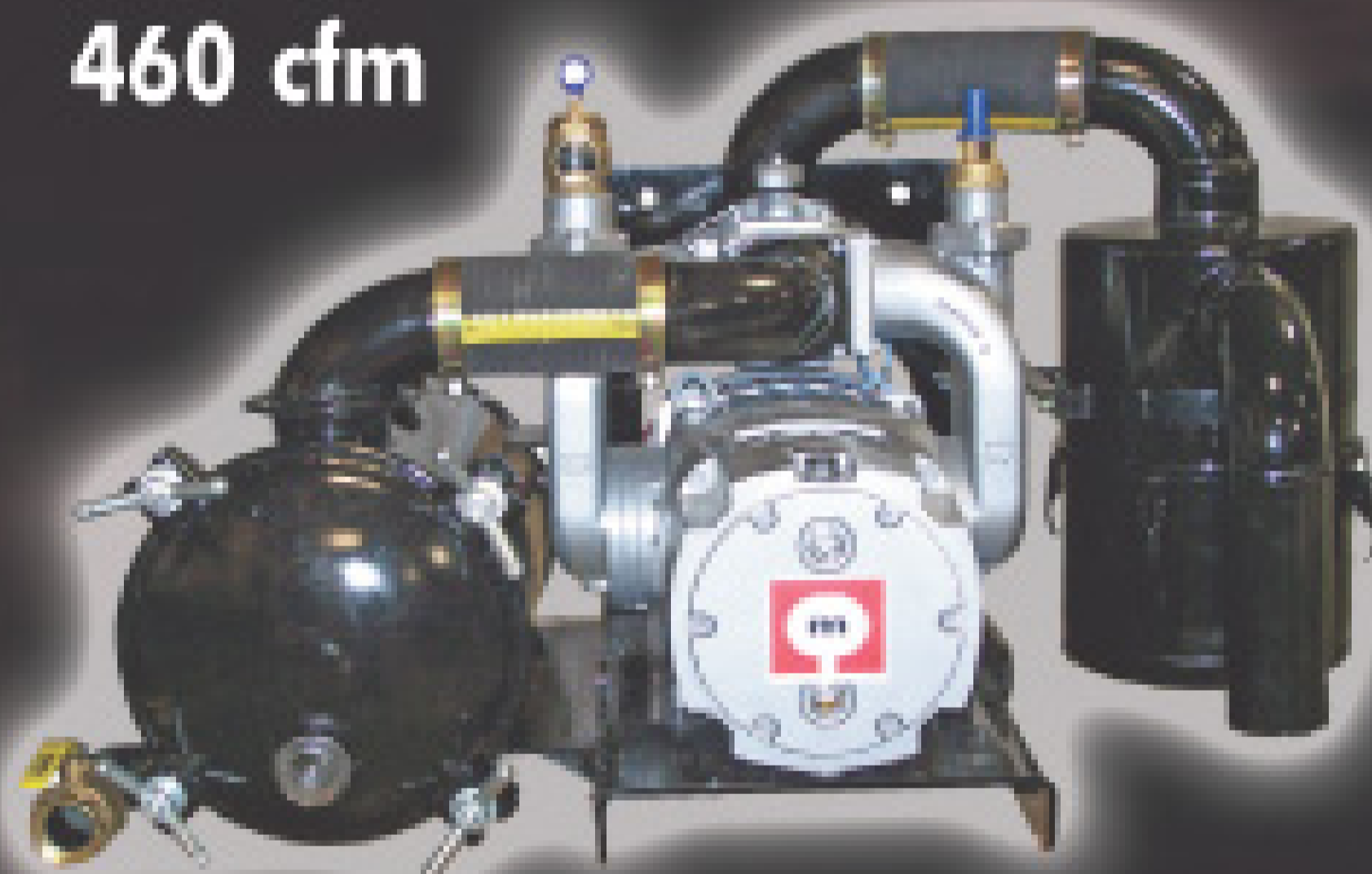

RIGHT ANGLE, HYDRAULIC,
GAS OR DIESEL PKGS.
AVAILABLE
ON ALL PUMPS



PM2600 824 cfm

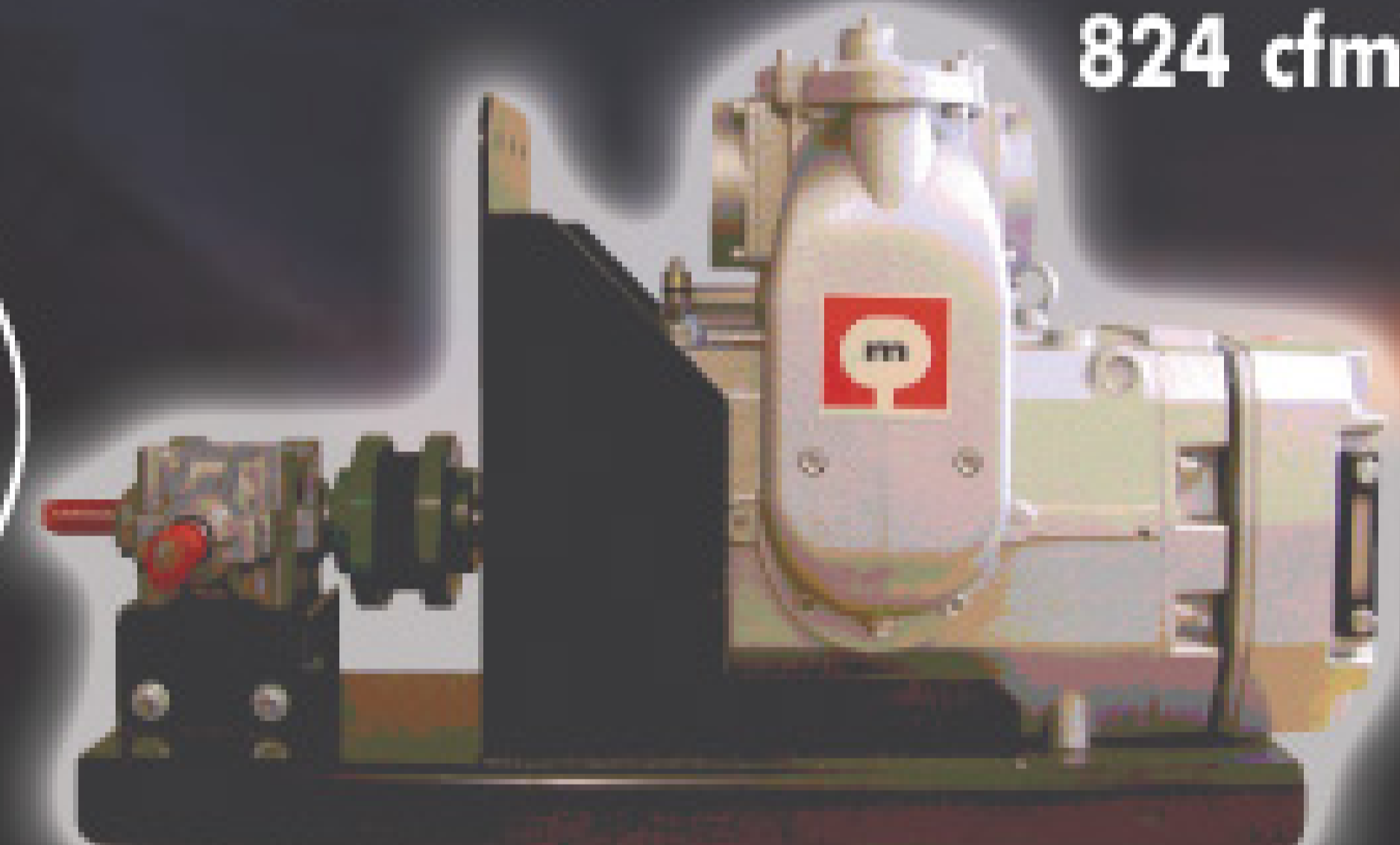

DC-STAINLESS Washdown Pump

NO COMPARISON



NO more RUSTY water!

OUTPERFORMS the Burk's cast iron DC-10!

NO More FROZEN pump!



316 Stainless Steel Mounting Brackets, Pump Head & Impeller

Quality RIV Components In Stock — Ready for Shipment



ACCU-LEVEL Accurate Tank Volume Measurement

No Balls • No Tubes • No Floats • No Worry!
No Internal Tank Components

Get paid for what you pump! Only pay for what you dump!



Level Indicator

Factory calibrated, the general purpose indicator reads 0-100% of volume in gallons. A single push button allows users to scroll through their active channels.



Pick-up Unit

The general purpose two-wire transmitter provides non-contact level measurement up to 32' and is ideally suited for challenging corrosive, coating or waste liquids.

ADVERTISER index

June 2008

27th Trucks, Inc.49

A



Abbott Rubber Co., Inc.20



Abernethy Welding & Repair95
Accent Manufacturing28
ACG Equipment Finance86
Acro Trailer Company107



Advance Pump & Equip.19
American Machine & Tool Co. 108
Amigo Truck Ltd.20
Amthor International86
Aqua Ben Corp.123



Aqua-Zyme Disposal Sys.68



Arcan Enterprises Inc.90



ARMAL Inc.93



Armstrong Equipment48,88
Atlanta Rubber & Hyd.74

B

B & W Mantrad Inc.88
Badger Truck Center94



Bandlock Corp.61
Best Enterprises, Inc.75
Big Fish Environmental38
Black Tie Mfg. Inc.36-37
Blue Angel Pump94
Brenlin Co. Inc./Seal-R106



Bright Technologies56

C

Cadman Power Equipment.38
Call-A-Head Corp.26



Cam Spray4
Cape Cod Biochemical73
Capital Partners LLC107



Capital Rubber Corp.34
Center Capital Corp.89

C



Chandler Equipment Inc.9
Chempace Corporation109
Circle D Truck Sales38



Clear Computing Inc.34



Comforts of Home52
Community Leasing82



Crust Busters/Schmitz Bros. 104

D

Del Vel Chemical Co.34
Denver Truck Sales106
Dragon Products16-17
Drop Box Inc.4
Dunham & Morrow Inc.78

E

Ecological Laboratories24



Elastec/American Marine74
Engine & Accessory Inc.90
Excel Equip. & Supply103
Explorer Trailers - McKee28

F



F. S. Solutions81
Fergus Power Products121
Five Peaks Technology87
FKC Co. Ltd.69



Flo Trend Systems Inc.106
Fournier52
Fruitland Tool & Mfg.78

G

GapVax Inc.111
Global Vacuum Systems Inc. 59
Granite Leasing Co.56
Guzzler Mfg. Inc.91

H

Hampel Corp.57
Hannay Reels40
House of Imports5
Hull's Truck Bodies18
Hydro Physics22

I

Imperial Industries Inc.29

J



J&J Chemical Co.47
J.C. Gury Company Inc.107



Jag Mobile Solutions67
Jetstream of Houston26

K

KeeVac Industries Inc.63
Keith Huber Inc.92
Kentucky Tank Inc.100
Key Commercial Corp.123
Kuriyama of America Inc.52

L

L.C. Tanks43
L.M.T. Inc.50
Labrie Environ. Group27
Lane's Vacuum Tank Inc.73

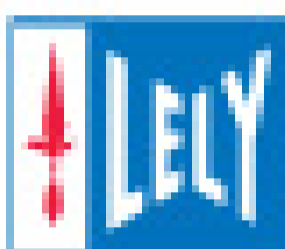

Lely Manufacturing Inc.24
Lely Waste Solutions60



Lenzyme/Trap-Clear Inc.78
Liberty Pumps42
Longhorn Tank & Trailer Inc. ..68

M

Magnets by Stamp Works114



Marsh Industrial40



Masport Inc.3
Michigan Vacuum Truck Inc. ..76
Mid-Continent Truck Sales ..115
Mid-State Tank58
Milwaukee Rubber Prod.18



Moro USA East Inc.7

N

National Truck Center79
National Vacuum Equip.70
NAWT Inc.66
Northeastern Mfg. & Sales ..109



NuConcepts90

O

Overland Tank Inc.112

P

Pat's Pump & Blower58



Pik Rite, Inc.108
PolyJohn Enterprises131
Polylok Inc.130
PolyPortables Inc.15, 77

P

PolyPortables Inc./Green Way ..101
Power Vac Inc.28
PowerFlo Products Inc.98
Precision Tank & Equip.26



Pressure Lift Corp.82
Presvac Systems Ltd.132
Prime Solution Inc.20
Prometheus Partners21



Prototek42

R

RA Ross N.E.114



Ritam Technologies LP42
Robinson Septic Service112
Rocket Supply Corp.109
RotoSolutions Inc.82
Rush Refuse Systems23

S

Safety Pumping Systems LLC ..76
Satellite Industries2, 64-65
SEMO Tank56



Septic Services Inc.84
Simple Solutions81
Sludge Mgmt. & Reuse108
Smithco Mfg. Inc.92
Specialty B Sales98
Super Products LLC48
Surco Products71
Sweet Septic Systems Inc.70

T

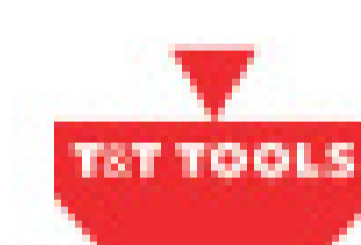

T&T Tools Inc.18
Tank Truck Service & Sales ..116



Tank Technologies & Supply Co LLC
TankTec10-13
The Service Program121



Toico Industries Inc.105
Tracker Solutions114



Transport Truck Sales53



Transway Systems Inc.97
Truck Town Inc.121
TSF Company Inc.41

T

TST, LLC99
Tuf-Tite Inc.51

V

V.E. Enterprises Inc.85
Vac-Con, Inc.39
Vacutrux Limited35



Vacuum Sales Inc.50



VAR Co.84

W

Walex Products Co.33
Wallenstein Pumps-Elmira ..100
Water Cannon113
Wee Engineer Inc.83



Wells Cargo COG60
Westmoor Ltd.25
White River Distributors114
Wilcox Truck Sales70
Wolf Creek Co., Inc.58

Classifieds117
Marketplace122
Truck Stop126

REGIONAL ADVERTISERS

Western Supplement

(after page 66)

Armstrong Equipment3
Custom Tank & Equip.6
Erickson Tank & Pump1
James Wilbee Company.4
TRS Industries6
West-Mark Inc.5

Midwest Supplement

(after page 66)

Allied Tank1
Bosserman Tank & Truck6
Engle Fabrication Inc.5
Liberty Financial8
Marengo Fabricated3
Mid-State Truck Service6
Milwaukee Rubber4
Pierson Co.8
Rider Vacuum Sales7
T-Line Equipment Inc.5
V&H Inc.8

Eastern Supplement

(after page 66)

Allied Tank1
Andert4
Bay State Truck2
Bosserman Tank & Truck6
Cellofoam2
Liberty Financial6
Manchester Hose4
Marengo Fabricated3
Southcoast Equipment7
TSI Tank Services5, 8
V&H Inc.8

JUROP TEAM OF PUMPS ALWAYS GETS THE JOB DONE



TALLADEGA



JUROP
Vacuum Pumps &
Blowers are designed
to deliver a high level
of performance.

The Original Bolt-N-Go Units

Made for the quickest
pitstop in the field,
don't finish last with a
competitors design.

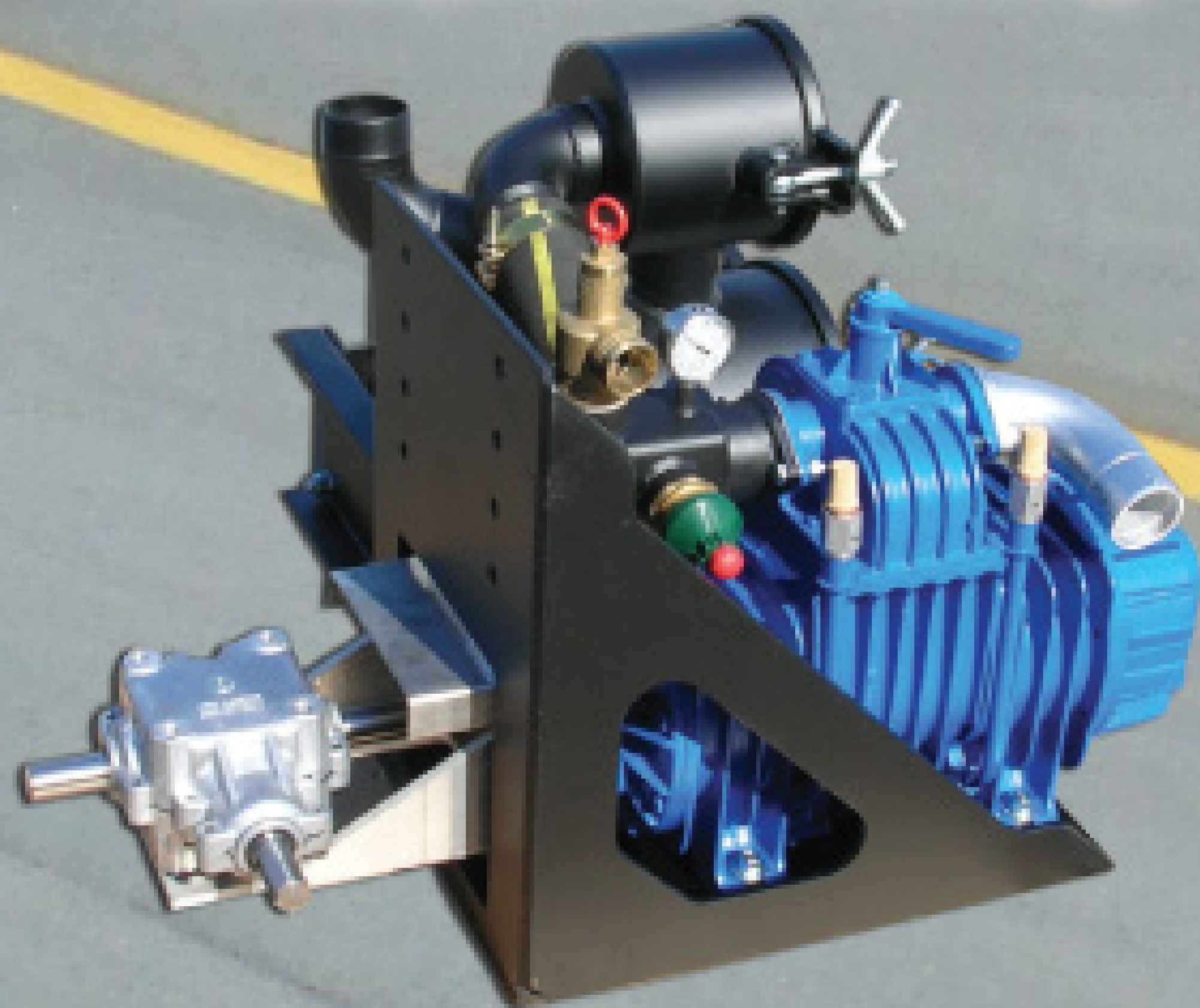

LC300 CONTENDER

This **Water Cooled Champion**
supplies 300 CFM and can
handle the toughest jobs while
maintaining 27" continuous
vacuum.



Call
800-342-0887
for a dealer near you
www.chandlerequipment.com

TankTec

Tank Technologies & Supply Co. LLC
Portable Restroom Service Trucks
Septic, Grease & Grit Trucks
Refined Fuel Trucks

Combination Septic/Restroom Service

2000 Gallon Aluminum Tank

2008 4400 Series International

2000 Gallon (2) compartment – 500/1500

Standard pumping system with Burks DC10 washdown

Upgrade to Masport HXL15 pump (350 C.F.M.)

Walkway to manhole on passenger side,

Manway in rear head, Extra manway top waste compartment

All normal features including unit hauler & hitch

2008 4400 International

DT466, automatic transmission

Hydraulic brakes

Sale Price: \$83,040 F.O.B. Kansas City

from... \$1,399 mo.



1500 Gallon Restroom Tank

Masport HXL4, Burks DC10, Hot shift PTO, Dual service

2008 International Cab Forward 19,000 G.V.W.

Auto trans., Hydraulic brakes

\$72,730 As Low As... \$1,228 mo.



2000 Gallon Restroom Tank

Masport HXL4, Burks DC10, Hot shift, Dual service

2008 Sterling – Acterra 26,000 G.V.W.,

Automatic transmission, air brakes.

\$81,177 As Low As... \$1,399 mo.



2008 Kenworth T300 Cummins, auto trans.

1700 Gallon (2) or (3) Compartment Restroom Tank

Masport HXL4 vacuum pumping system

Burks wash down, Hot shift PTO – all the extras

\$76,900 As Low As... \$1,043 mo.



2007 International 4200 series

Auto transmission, air brakes

1700 gallon (2) Compartment Restroom Tank

Masport HXL4, Burks wash down, Hot shift PTO.

\$76,900 As Low As... \$1,298 mo.

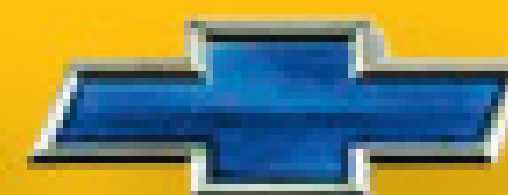

Sale!

SAVE! On Every **IN STOCK** Restroom Service Truck!

IMMEDIATE DELIVERY Drive It Off The Lot Today!

Financing & Lease Options To Fit Your Business

888-428-6422



Cummins 305 HP Diesel / 610 lbs ft torque / 'Life to Overhaul' 350,000 miles
7,000 lb front axle - 13,500 rear axle - 50,000 P.S.I. Heavy Duty frame
Exhaust brake / Chrome bumper / 52 gallon fuel tank / Tilt steering / AC...

2008 Sterling Bullet Restroom Service

Cummins 6.7 liter turbo diesel-305 HP, limited slip rear, 6 speed manual, 7000 lb front / 13,500 lb. Rear Axle, Exhaust Brake, AM/FM-CD, Cruise...more!

1250 Gallon Tank (2) Compartment Masport HXL4, dual service, Burks DC 10 wash down system, Tow package and toilet carrier.

Sale Price: \$66,950

F.O.B. Kansas City

As Low As... \$1,199 mo.



2008 Sterling Bullet

Cummins 6.7 liter turbo diesel-305 HP, limited slip rear, automatic trans., 7000 lb front / 13,500 lb Rear Axle, Exhaust Brake, AM/FM-CD, Cruise.

1500 gallon (2) Compartment Restroom Tank

Masport HXL4, dual service, Burks DC 10 wash down system, Hot shift P.T.O., tow package and toilet carrier.

Sale Price: \$69,500

F.O.B. Kansas City

As Low As... \$1,190 mo.



New 2008 Sterling Bullet (4) Wheel Drive

Cummins 6.7 liter turbo diesel-305 HP, limited slip rear, auto transmission, 7000 lb front / 13,500 lb rear axle, exhaust brake, auto transmission, **oversized suspension package**, power windows, locks, mirrors, keyless entry. *Includes a two year tow package from Sterling.*

1500 Gallon (2) Compartment Restroom Tank

Masport HXL4-dual service - Burks DC 10 wash down Hot shift PTO/ w/remote, tow package and toilet carrier.

Sale Price: \$73,400

F.O.B. Kansas City

As Low As... \$1,299 mo.



Tank Technologies & Supply Co. LLC • 888.428.6422 • www.tanktec.biz

Steve Nelson • snelson@tanktec.biz
Andy Nelson • anelson@tanktec.biz

Local • 763.755.8075 • Fax • 763.757.9788
10100 Quinn St. NW. Minneapolis. MN 55433

TankTec

Tank Technologies & Supply Co. LLC
Portable Restroom Service Trucks
Septic, Grease & Grit Trucks
Refined Fuel Trucks



2008 Sterling 9500 Series

410/450 Mercedes diesel, 10 speed,
18,000 front – 40,000 rear (air ride)

Very heavy duty specs – loaded!

New 4800 Gallon Aluminum Septic

Moro 824 C.F.M. Vacuum pump

All standard features – tool boxes

Sale Price: \$132,000

F.O.B. Kansas City

Plus F.E.T.

Pusher axle available

Monthly Lease From...\$2,448

2008 Sterling 9500 Series

410/450 Mercedes diesel 10 speed
18,000 front – 40,000 rear (air ride)

Very heavy duty specs – loaded!

New 4200 Gallon Aluminum Septic

Masport HXL400 water cooled pump

All standard features – tool boxes.

Sale Price: \$125,500

Plus F.E.T. F.O.B. Kansas City

Monthly Lease From...\$2,137



2008 Peterbilt Model 340

330HP Cummins diesel – 10 speed
14,600 front – 40,000 rear (air ride)

New 3600 Gallon Aluminum Septic

Masport HXL400 water cooled pump

All standard features

Large tool box

Sale Price:

\$106,000

F.O.B. Kansas City

Plus F.E.T.

Monthly Lease From...\$1,438

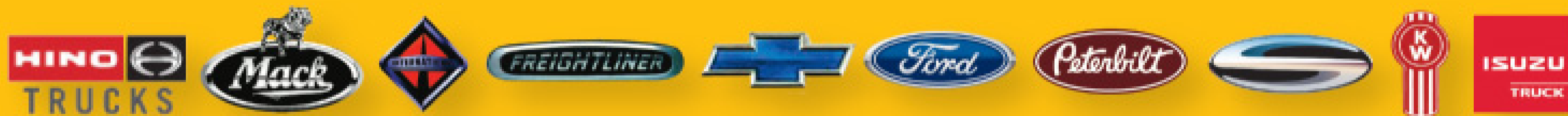

Sale!

SAVE! On All **IN STOCK** Septic Service Tanks!

IMMEDIATE DELIVERY On The Lot Selection!

Financing & Lease Options To Fit Your Business

888.428.6422

Refurbished Chassis New Tank & Equipment

Refurbished 2006 Peterbilt Model 335

330 H.P. – 10 speed transmission
74,000 miles – air ride suspension
Looks & Operates Like New!

New 3600 Gallon Aluminum Septic Tank

Masport HXL400 water cooled pump
All standard features – large tool box

Sale Price: \$103,695

Monthly Lease From...\$1,718

Plus FET (tank only) F.O.B. Kansas City



Refurbished 2001 Freightliner FLD112

ISM 330 H.P. Cummins – 9 speed,
200,000 mile power train Warranty
Looks & Operates Like New!

New 3600 Gallon Aluminum Septic Tank

Masport HXL400 water cooled pump
All standard features – large tool box

Sale Price: \$82,000

Monthly Lease From...\$1,377

Plus FET (tank only) F.O.B. Kansas City



**200,000 Mile
Power Train
Warranty**

2000 Septic Tank - Grease Trap

Masport HXL75

2007 Chevrolet 7500 Series

Automatic transmission, Air brakes

Sale Price: \$76,800 F.O.B. Kansas City

Monthly Lease From...\$1,289



7000 Gallon Trailer

5454 Aluminum- 3/8" heads, Full length hose trays,
(2) ladders, rear bumper, 6" discharge 4" inlet,
Hendrickson air ride suspension, (2) 25,000 lb.rear axles

Sale Price: \$54,000 Plus FET

Monthly Lease From...\$899

F.O.B., Arthur, IL



Tank Technologies & Supply Co. LLC • 888.428.6422 • www.tanktec.biz

Steve Nelson • snelson@tanktec.biz
Andy Nelson • anelson@tanktec.biz

Local • 763.755.8075 • Fax • 763.757.9788
10100 Quinn St. NW, Minneapolis, MN 55433

Growing Leaders Takes Time

Look for workers with great potential to advance the business, then invest in their development

By Gary Bradt

Time management is a great idea for organizing your pumping business, building efficiency and getting things done. As a tool for leading people through change, however, it misses the mark. In fact, managing time is the last thing you want to do when leading change.

Instead, invest time, and lots of it, in the people with potential to help you lead change. The returns may surprise you, and I have an incredible story to illustrate the point.

A few years ago, I became upset when a player on the NFL's Carolina Panthers attacked a teammate and subsequently was suspended by the team for one game. I felt the punishment was too lax (after all, the attacked teammate ended up in the hospital) and wrote an angry letter to the team's owner, Jerry Richardson, expressing as much.

To my surprise, Richardson not only acknowledged my letter, but he went one giant step further. He offered to visit me and my 13-year-old son, who was a big fan of the team, and would bring along the star player in question, wide receiver Steve Smith.

MAKING A DIFFERENCE

The pair made the two-hour drive from team headquarters to my home and stayed with us for three hours. I learned that day

that Smith is a good man who made a bad mistake and was willing to learn and take responsibility for his actions. I admire him for that. From Richardson, I learned the power of a leader being personally invested in future leaders who can make a difference.

Richardson invested time in me that day, but more importantly, he invested time and energy in Smith, someone with potential to lead change on the football field. I can only imagine the discussions they had as they drove back and forth and the bonds they forged and then carried forward.

I don't think it's a coincidence that the following season Smith emerged as a star and helped lead the Panthers to a Super Bowl appearance.

Richardson identified Smith as someone I call a diamond-in-the-rough, a leader with untapped potential. Then, he personally invested his time and energy to help Smith unleash his potential. You can do much the same for the uncut diamonds in your company. Here are four tips to help get you started:

Hold yourself accountable for people development

Common comfort zones, such as crunching numbers and formulating strategy, have their place. But both aspects of your business are useless if you don't

have leaders to execute accounting and planning procedures. Therefore, hold yourself accountable for the people side of the business, too. Recognize more pressing issues will always come up, so do whatever it takes to make finding and developing people a priority. Schedule time for building relationships into your calendar. Make a list or create a spreadsheet to track your progress if you must. Set goals for people development and hold yourself to them.

Identify your "diamonds-in-the-rough"

You can't invest in your future leaders if you don't know who they are. Some "diamonds" are obvious. Their talent and ability dazzles and stands out. But others may require energy and effort to unearth. Try using the technique of management by walking around. Get out of your comfort zone. Take the new employee to lunch. When you go out in the field, make it a point to meet people relevant to your business, then follow up with them.

Polish your gems by asking questions

The best leaders ask questions — lots of them. They don't invest much time in running around telling people what to do. In fact, they don't hire people who have to wait to be told what to do. Instead, they unleash talent by presenting problems and asking for ideas rather than offering solutions. They understand their job is to lead, not to do. They encourage people to think. They encourage people to act. They remove organizational

roadblocks that hold talent back.

Explore ideas and build relationships beyond the boundaries of work

Engage people on a variety of topics beyond your common industry issues. Refining someone's leadership skills often requires helping them look beyond their everyday world for novel solutions and product innovations they can bring back to their work. Become emotionally invested, too. Spend time getting to know your future leaders. Find out what matters to them, at and away from work. Sometimes engaging in small talk can lead to big insights. You may discover a personal situation that is holding someone down or holding him or her back, such as the illness or loss of a loved one. You may not be able to do anything tangible to help, but simply knowing that you care can be reassuring and provide a boost. If you want people to be there for you when the going gets tough, you need to be there for them first.

A FINAL WORD

If investing in people sounds like a "soft" activity to you, you're right. It's not about immediate bottom-line results. But rare is the business that can consistently return good, hard results without making soft investments in people first. People determine whether you win or lose, whether the game is football or business. To better lead change, stop managing your time and start investing it in people. Then enjoy as the wins pile up. ■

Gary Bradt is author of the book, *The Ring In the Rubble: Dig Through Change and Find Your Next Golden Opportunity*. He can be reached at www.ringintherubble.com



Spend time getting to know your future leaders. Find out what matters to them, at and away from work. Sometimes engaging in small talk can lead to big insights. You may discover a personal situation that is holding someone down or holding him or her back, such as the illness or loss of a loved one.



VANTAGE POINTS!

When you add up the facts, there's no advantage like the Vantage!

- Reinforced corners hold their shape. No exterior molding.
- Double-walled construction for extra strength
- Smooth interior walls for quick, easy cleaning
- Waist-high strap-down guides on all four corners
- Eight huge hand-holds make handling a breeze
- Versatile parts fit other restrooms in the PolyPortables' family
- Now 14 popular colors, plus custom colors on orders of 100 or more

Flexible Financing available for a limited time

Tell us what you need: Lower payments? Longer terms? Less interest? Deferred payments? Choose the options that are best for you.

Visit us online at the new PolyPortables.com



99 Crafton Drive, Dahlonega, GA 30533 USA • Phone (800) 241-7951 or (706) 864-3776 • Fax (706) 864-8111 • www.polyportables.com

Only PolyPortables offers high-performance Green Way Products

TOILET DEODORIZERS • TOILET CLEANERS • AIR FRESHENERS • INSECT REPELLANT

All Green Way deodorizers, cleaners and air fresheners are earth-friendly, people-friendly products. They are developed and manufactured in our facilities in Dahlonega, Georgia by Green Way Products, a PolyPortables sister company.



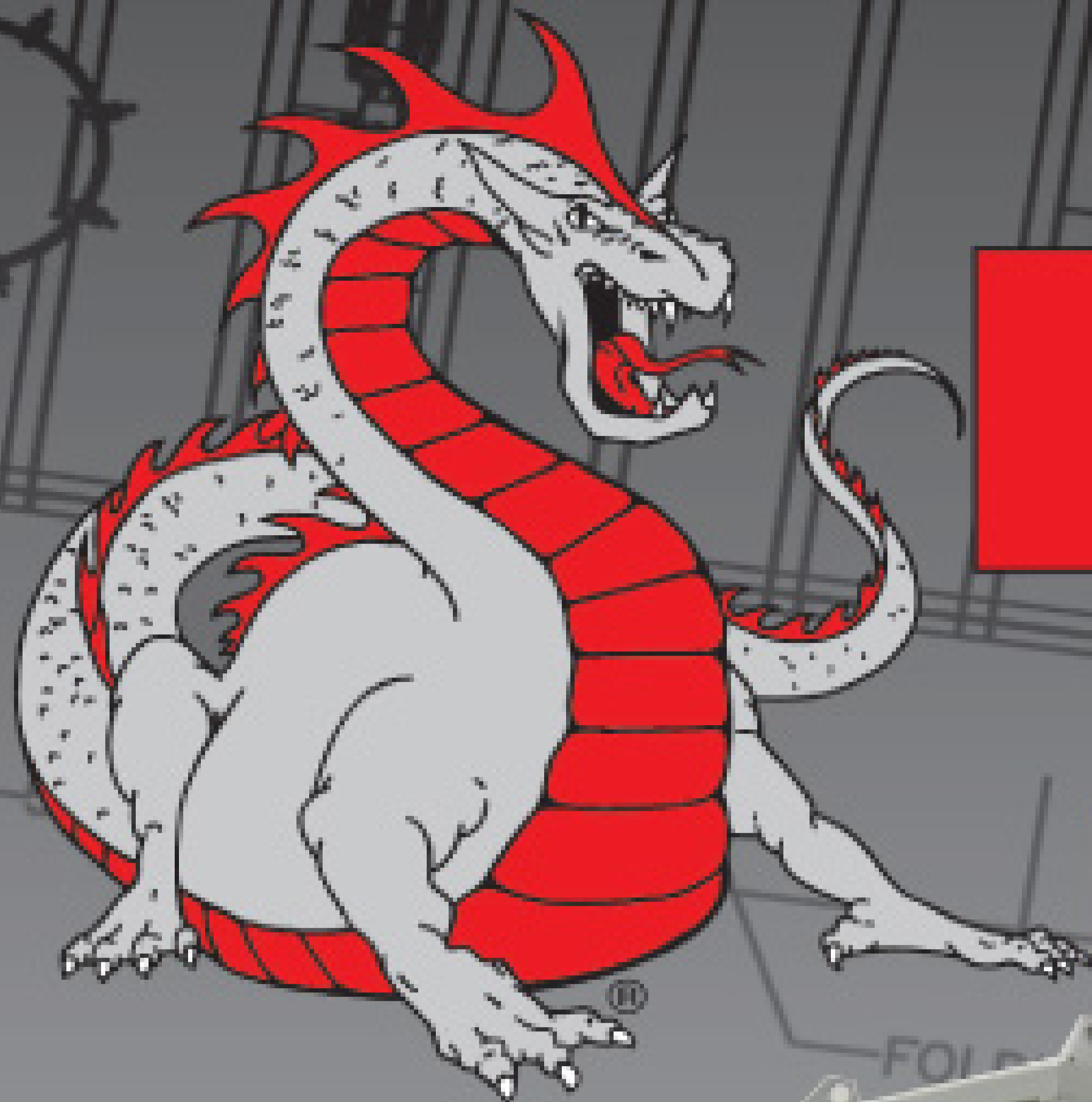

DRAGON

PRODUCTS, LTD.

PUMPS DIVISION

A Modern Group Company



come see our displays
Booths Number
Inside 1125
Outside: 7311

Custom fabrication to meet our customers specific needs in the Petrochemical, Shipping, Drilling, Agricultural and Mining industries. All Dragon pumps, agitators, hoppers and pump packages are assembled in Liberty, Texas.

All internal pump parts such as bearings, shafts, and mechanical seals are from the highest quality parts and materials made in the USA.

We maintain a huge warehouse of motors by Baldor and Reliance and starters by Sprecher & Schuh/Allen Bradley.

We also have a full stock of replacement parts for your pumps which are 100% interchangeable with other popular pumps on the market. Dragon is the largest stocking dealer of **Fruitland Pumps and Parts** in the U.S.A.



1-866-914-8198

email: sales@modernusa.com

website: www.modernusa.com

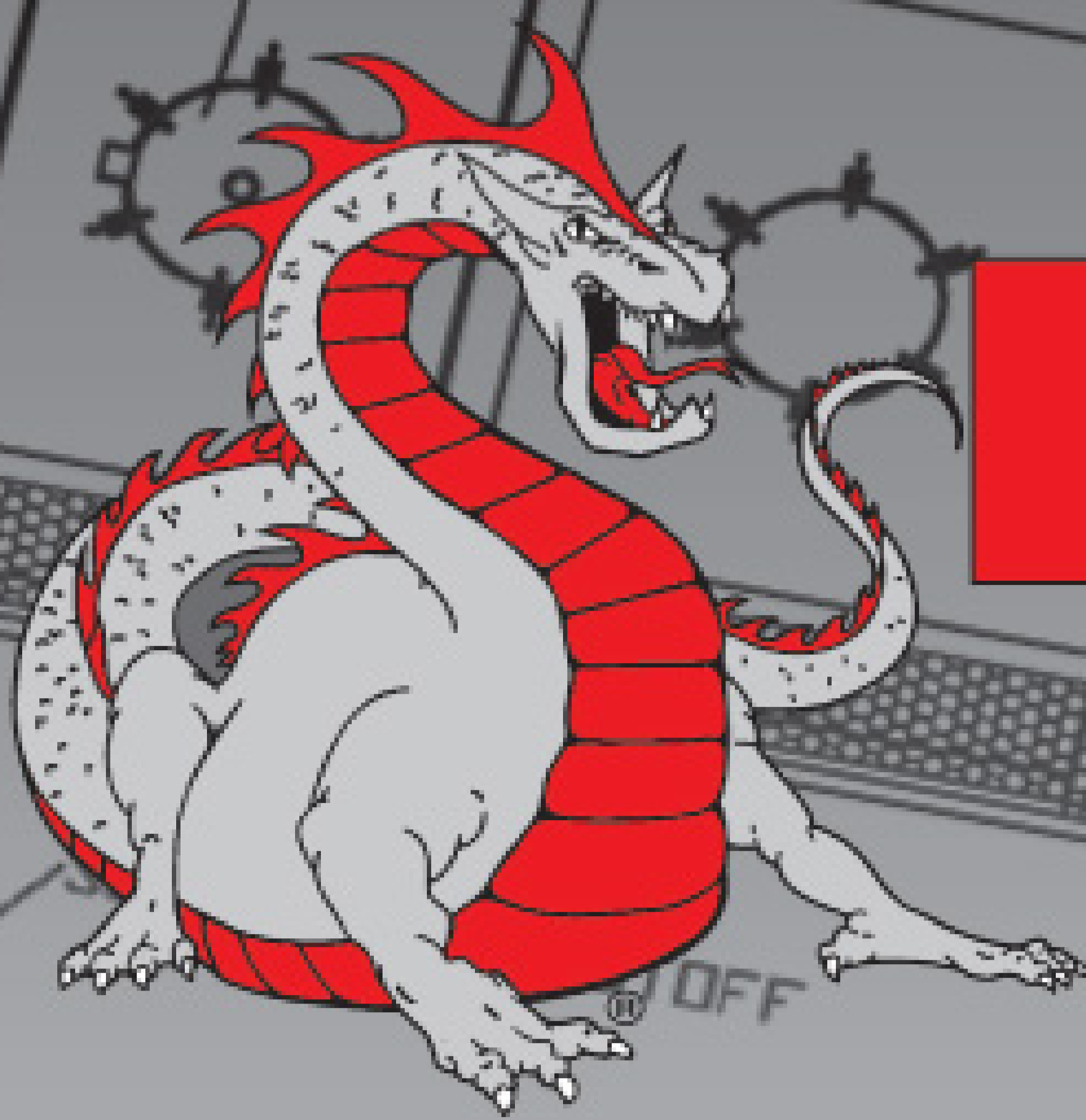

DRAGON

PRODUCTS, LTD.

A Modern Group Company

Waste Expo 2008
Booth 675

150 BBL ALUMINUM &
130-160 STEEL &
STAINLESS STEEL
CODE AND NON-CODE
VACUUM TRAILERS



30-80 BBL STEEL &
ALUMINUM BOBTAILS



SINGLE & TWO CONTAINER
ROLL-OFF TRAILERS



500 BBL
LIQUID TIGHT
SMOOTH WALL
CONTAINERS



VACUUM ROLL-OFF
CONTAINERS

Looking for Great Deals on Quality
Used Equipment?
Check out our web-site at:
www.modernusa.com

(877)778-4280

email: sales@modernusa.com



Ask about our easy
Credit Terms and
Convenient
Financing.

T&T TOOLS

T&T TOOLS, Inc.

FAX: 800.521.3260 | EMAIL: sales@TandTtools.com

800.521.6893

www.TandTtools.com

CALL FOR A FREE CATALOG!

CALL FOR A FREE CATALOG!

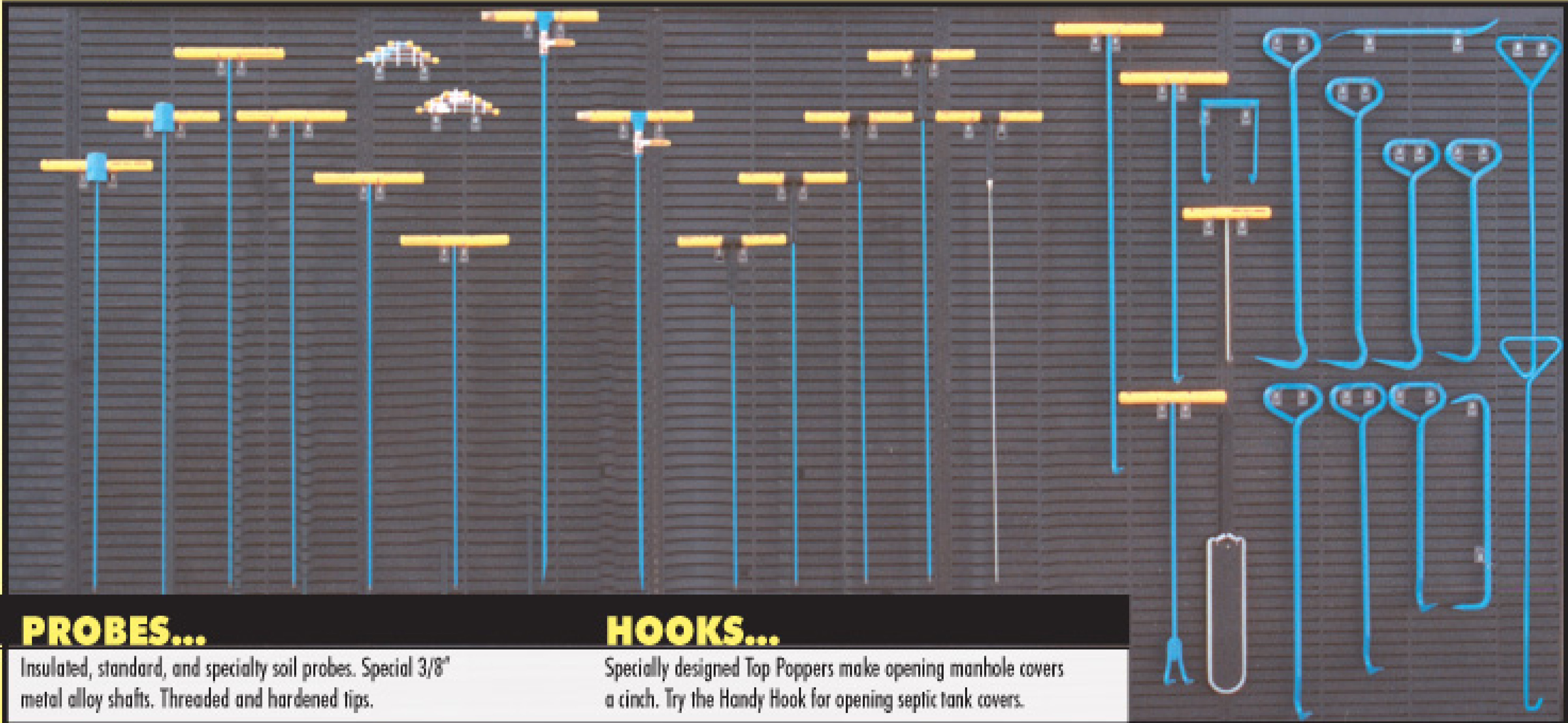

PROBES...

Insulated, standard, and specialty soil probes. Special 3/8" metal alloy shafts. Threaded and hardened tips.

HOOKS...

Specially designed Top Poppers make opening manhole covers a cinch. Try the Handy Hook for opening septic tank covers.

Hull's Truck Bodies

459 Joe Shoemaker Rd. | Minford, OH 45653

Vacuum Trucks built to order, any size or make, delivery to all 50 states. Quick turn around time.



Phone: 877.898.5104

E-mail: hullstruckbodies@yahoo.com

Webpage: hullstruckbodies.com

Kanaflex® 220RS Rubber All-Weather Suction Hose

SUPER FLEXIBLE IN COLD WEATHER

Call for Low Prices on 100' Lengths & Coupled Hose Assemblies

A revolutionary new method of manufacturing rubber suction and discharge hose has drastically reduced costs to hose users. The new process, ten years in development, utilizes Kanaflex SBR TYPE "T" POLYMER to give the lightweight, rubber hose outstanding flexibility and long life.

New Series 220 rubber suction and discharge hose has excellent dimensional stability and is easy to couple. Manufactured in six sizes from 1-1/2" through 6", the hose is available in 100' lengths. I.D. and O.D. are smooth. Temperature range is -40° F to 160° F – ideal for industry and construction job site use.

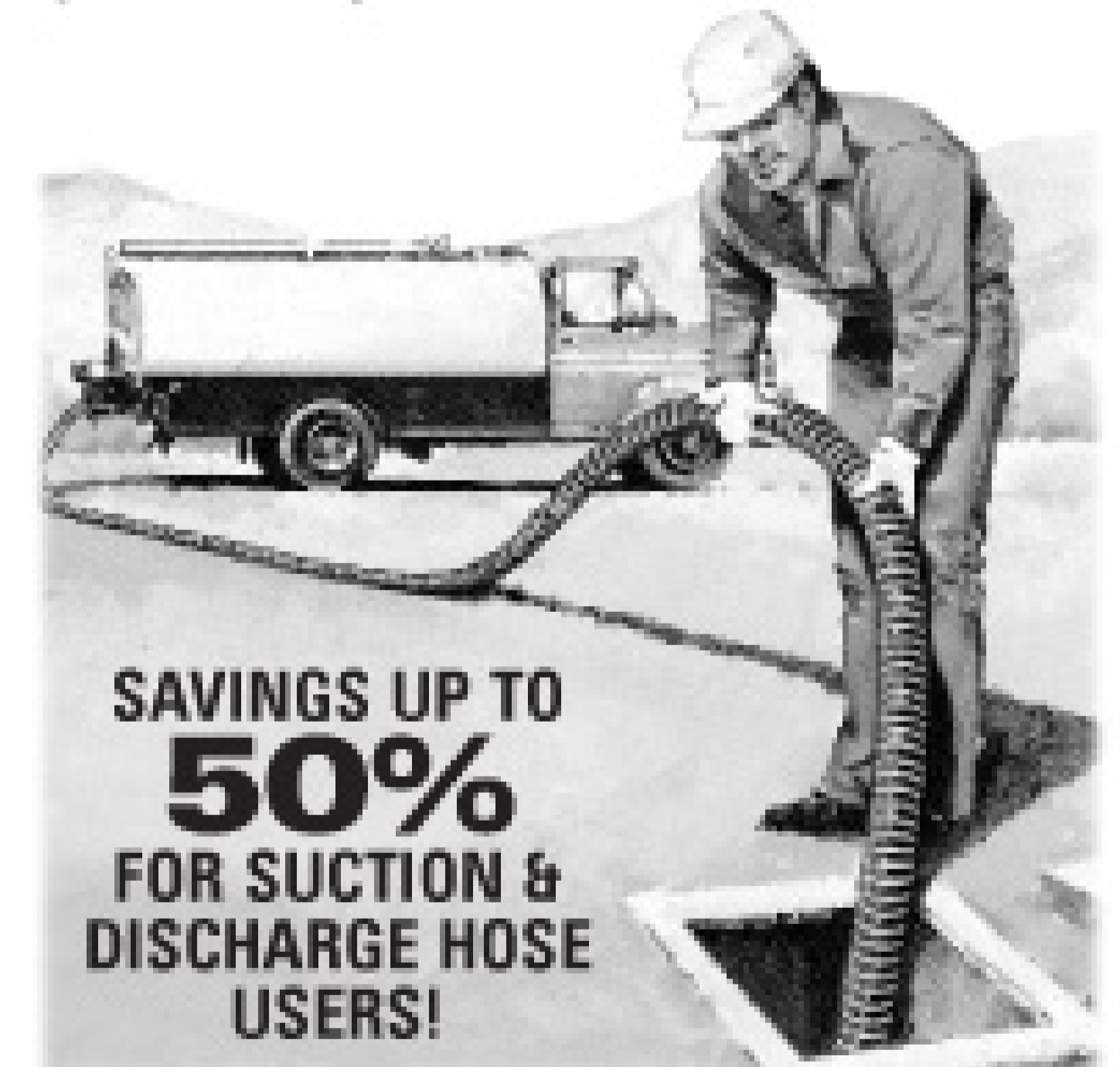

SAVINGS UP TO **50%** FOR SUCTION & DISCHARGE HOSE USERS!

Distributors of: Dunlop • Goodyear • Kanaflex • Plastiflex Hi-Vac & Other Hose • P-T & Evertite Quickcouplers Dixon & Le-Hi Couplings • Hose Clamps • Banding Equip.

MRP

Milwaukee Rubber Products, Inc.

Toll-Free **1.800.325.3730**

www.milwaukeeerubber.com

FAX: 262.781.1742

MAILING ADDRESS: P.O. Box 451 . Butler, WI 53007

WAREHOUSE: N52 W13319 Falls Creek Ct. . Menomonee Falls, WI 53051



Advance

PUMP & EQUIPMENT INC

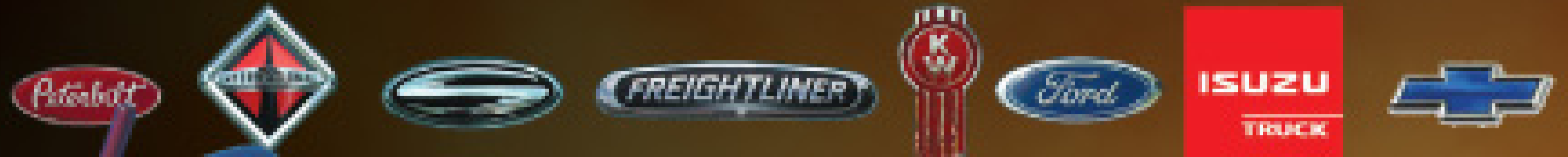

**Custom
Pump
Trucks
Built to
Your Specs**



**Call Today
For
Professional
Blower
Installation**

Thanks Glenn

Enviro-Pump Plus of Balaton, Minnesota
3900 gallon "Polished" Stainless Hoist/Rear Door
with 957 NVE Blower System.

NVE
DISTRIBUTOR



**6000 Gallon
Short Tanker Trailer**

- Excellent for Septic & Grease Trap Service.
- Call for more Information

**Less Trips =
Less Fuel**

**Introducing the JT530
\$4,250.00**



Toolbox Jetter JT530

- Polished Aluminum Toolbox
- 5 GPM @ 3000 PSI Water Pump With Pulsator
- Electric Start Engine
- Remote Fuel Tank
- Electric Rewind Reel With 200' of 3/8" Hose
- Chrome Guide Rollers On Reel
- Washdown Gun With Quick Connect Tips
- (1) Jet Nozzle
- Stainless Tool Rack

**Add Jetting
To Your
Pump Truck**

**Introducing the JT1030
\$5,995.00**



Toolbox Jetter JT1030

- Polished Aluminum Toolbox (28 x 28 x 48)
- 10 GPM @ 3000 PSI Water Pump w/Pulsator
- Gearbox Drive - Standard or optional Hydraulic Drive
- Bucket Fill/Drain
- Air Rewind Reel w/200' of 1/2" Hose
- Chrome Guide Rollers on Reel
- Wash Down Gun w/ (4) Quick Connect Tips
- Jet Nozzle - Flushing
- Includes Mounting Brackets

Toll-Free 1.877.557.PUMP (7867)
"Partners in Performance"

Call For A Quote Today!

www.AdvancePump.com
15418 Old Highway Road • Peosta, Iowa 52068
877.557.PUMP (7867) • Fax: 563.557.0961

HOSE ASSEMBLIES

MANUFACTURED TO YOUR EXACT HOSE REQUIREMENTS BY THE LEADING SOURCE IN HOSE FABRICATION.



**LOWEST PRICES
GUARANTEED
ON ALL OF OUR**

"QUICK-SHIP"

ITEMS

INCLUDING
HOSE & ASSEMBLIES
COUPLINGS • VALVES • ADAPTERS

300EPDM • 180AR • 180HR • 180BL
390SD • 220RS • GREEN PVC
KANALINE SR • KANAPOWER AT

Genuine

Kanaflex®

Assemblies by

ABBOTT

300EPDM HOSE NOW AVAILABLE IN COLORS

GREEN/BLACK - BLUE/BLACK - RED/BLACK

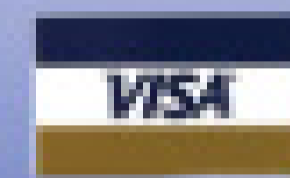

RUBBER COMPANY, INC.

1700 Nicholas Blvd. Elk Grove Village, IL 60007

www.pumperhose.com

1-800-852-1855 FAX: 847-952-0156

sales@pumperhose.com



(800) 800-7575

(713) 675-7575 • Cell (713) 539-0055

Houston, TX

710 McCarty Drive • Charlie McDaniel

See Our Inventory: www.amigotruck.com



PETERBILT - New Cusco TurboVac HydroExcavator, 3200 usg: 2200 debris + 1000 water, hydraulic dump, full opening rear door, dual 8" steel cyclones, 3600 cfm, dual steering, double frame, vibrator, wash system with 18 gpm 3000 psi, 6" hydraulic boom with 360° rotation, stock #6517; Call for Price

"Heavy Duty Headquarters"

We Squeeze the Crap Out of Water™

Rotary Thickening and Dewatering

Simple systems that are
totally enclosed, compact
and easy to operate.



**PRIME
Solution
INC.**

PH: 269-673-9559

www.primesolution1st.com

Made In USA

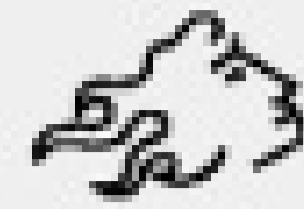

Placing a value on what you've built.

A knowledgeable buyer can make all the difference.

We own a portable restroom business in Southern California and North Carolina and are actively looking for potential acquisitions across the U.S. So if you have built a quality business in the portable sanitation industry, we would like to meet with you.

At Prometheus, we specialize in acquiring profitable, middle market companies in route businesses. And we are especially focused on the portable sanitation industry. Here's why you should contact us:



CAPITAL

Whether you are looking to sell your business or are looking to grow, you need capital. We are a cash buyer and can complete a transaction quickly.

Also, our relationships within the financial community provide access to additional sources of capital necessary to grow your business. If you are interested in selling a portion or all of your business or if you believe a committed equity partner can help you achieve the vision you have for your business, we would look forward to meeting with you.



Nicholas Peters
President & CEO

Wayne Stabile
Managing Director

Chris Suh
Director



PROMETHEUS

Wisconsin Tightens Maintenance Rules and Raises Sanitary Permit Fees

By **Scottie Dayton**

A new law restricting county septic regulators from soil testing and the installation, design, maintenance, repair, and sale of onsite systems takes effect on Nov. 1. The Department of Commerce is drafting rules on how to enforce the law.

Code changes redefine occa-

sional occupancy as occupying a building served by an onsite system for less than 120 days per year. County regulators may establish an alternative maintenance program for these systems or owners may provide regulators with written notices of occasional occupancy and a management plan.

The Wisconsin Onsite Water Recycling Association is concerned that seasonal properties should be maintained to higher standards, due to sporadic use and shock loads during peak periods.

The department will also increase plan review and sanitary permit fees, and raise the management license from \$60 every four years to \$90, and the soil

tester license fee from \$240 to \$300.

ONTARIO

The Ministry of Municipal Affairs and Housing proposes changes to the building code that would introduce administrative requirements to support the maintenance or inspection of onsite systems, and regulate tertiary treatment disposal beds. The Ontario Association of Sewage Industry Services is writing a position paper on the proposed changes. Look for it at www.oasisontario.on.ca.

PENNSYLVANIA

The state Department of Environmental Protection has proposed new onsite guidelines for land development, site suitability and alternatives analysis. The document will require townships and municipalities to adopt ordinances to oversee operation and maintenance of onsite systems when subdivisions or land developments are proposed. The guidelines will apply to subdivisions that have been exempt from planning.

The Pennsylvania State Association of Township Supervisors and Pennsylvania Association of Sewage Enforcement Officers encouraged the DEP to not release the guidance document until its new regulations are revealed and their effect can be determined. The DEP has not yet published a draft of those regulations.

Opponents argue that the cost to municipalities, developers, landowners and taxpayers could be high. Townships would have to inspect about one-third of their onsite systems annually, besides keeping track of them and per-

"Rules and Regs" is a monthly feature in Pumper. We welcome information about state or local regulations of potential broad interest to onsite contractors. Send ideas to editor@pumper.com.

mitting all repairs. Townships that have not adopted a sewage management ordinance have the authority to do so under the current regulations. View the document and PASEO's comments at www.pa-seo.org.

FLORIDA

A recent complaint investigation of alleged unlawful septic tank contracting revealed a misunderstanding centering on the licensing requirements for tank certifications and measuring tank volume.

According to Ed Barranco's article in the March newsletter of the Florida Onsite Wastewater Association, existing system and repair evaluations may be conducted by state-licensed engineers, Department of Health employees, registered and master septic tank contractors and private certified environmental health professionals.

Only registered or master septic tank contractors or licensed plumbing contractors who also are DOH-permitted septage cleaning services can conduct and give tank certifications. The department's new language clarifies these requirements and is ready for incorporation into the next version of the Florida Statutes.

FOWA is supporting bills before the legislature that would:

- Continue research on cost-effective methods to reduce nitrogen in springs.
- Direct the DOH to evaluate onsite nitrogen reduction systems and alternative nitrogen reduction media in drainfields.
- Require onsite systems installed before 1983 to be pumped and inspected every five years. ■

The Wisconsin Onsite Water Recycling Association is concerned that seasonal properties should be maintained to higher standards, due to sporadic use and shock loads during peak periods.

Introducing a root killer that actually Kills Roots.

When did you **NOT** find roots in older laterals?

It's a tremendous market, but you need more than just good advertising to do the job. You need a product that works time after time and is proven effective in numerous studies.

Exciting news! Vaporooter® the leading name in municipal root control, has contracted Hydro Products Corp. to release their EPA registered product to residential service companies. For a limited time, Hydro Products Corp., is offering exclusive US territories on a first come basis for qualifying companies. Here is how it benefits you:

- ◆ Huge Income Potential
- ◆ Exclusive Territory
- ◆ Proprietary Equipment
- ◆ Full Training
- ◆ Marketing Assistance
- ◆ Repeat business
- ◆ Light weight equipment
- ◆ Years of Municipal Success

Call: 800-781-3164

"So tough, you have to be licensed to kill!"



Refuse Systems

Your truck specialists in the solid and liquid waste industries.



2008 Peterbilt 365 with 5000 Gallon Tank

CAT C13 430HP 1650 Ft/Lbs Torque, Full Compression Brake (Three Stage), Allison 4500 RDS-P with 5YR/Unlimited Mile Warranty, 20,000# Front Axle; 46,000# Rear Axle, Peterbilt Air Trac Suspension, Full Locking Differential, Aluminum Wheels on Outside, Hendrickson Composites 13.2K Steerable Pusher Axle, Air Ride Driver Seat, Adjustable Steering Column, Power Windows, Locks, Cab Air Suspension, Pik Rite 5000 Gallon Carbon Steel Tank, See Level – Digital Tank Level Indicator, Moro PM100 Pump, Aluminum Hose Trays, 4" Intake, 6" Discharge.



Peterbilt 340 Industrial Vacuum Trucks

Automatics and Standards in stock ready for delivery. DOT 407/412 3150 Gallon Cusco units. Moro PM100 Pump, Hydraulic full opening rear, Vibrator Box, Air actuated valves, Full Walkway with handrail, 20 Ton Dump Capacity Cylinder.



Peterbilt 340 Standard Vacuum Trucks

Automatics and Standards in Stock ready to go to work. Non Code 3600 Gallon Pik-Rite Tank. Masport HXL400WV Liquid Cooled Pump, Aluminum Hose Trays, Internal Primary to secondary Piping for clean mount. 10 yr Tank Warranty Standard. Options can be added before delivery. Compare our standard Specs to anybody!



2007 Peterbilt Model 357 Roll Off

Pre 07 Emission, Cat or Cummins, 8LL Transmission, 20 Fr/ 44-46 Rears, Air Trac or Hendrickson Suspension, 60K or 75K Hoists, Pioneer and O'Brian Tarpers, Mounted or Cab and Chassis Still Available!



2007 and 2008 Peterbilt Cab and Chassis

Whether you're putting an old tank on a new truck, or custom building a truck the way you've always wanted, call us and choose from a wide variety of models and specs on the ground. Fast shipping available to your destination. Tank dealers and manufacturers welcome.



www.rushrefusesystems.com



877-661-4511

Refuse Sales Team: Gregg Wilkinson | Jason Guzauskas | Jesse Fullilove | Ryan Johle | refusesales@rush-enterprises.com

8810 IH-10 East | San Antonio, TX 78219

Time To Save At Lely!

4000 Gallons!



Aluminum
or ...

... Steel



Financing Available

Steel Tanks in Stock, ready to be mounted on your truck



300 + 100 Gallon Ready to go unit that will fit in the back of your pick-up



The original Gem Jet is still the best.
2000 psi @ 15 gpm



Most efficient separator on the market



Still the most inexpensive separator on the market.

Sales Representatives
John Minnis
540-547-2463

Charlie Gilantzis
252-360-6331

Roy Coffey
828-312-9545



LELY MANUFACTURING

P.O. Box 789 • Wilson, NC 27893
252-291-7050

FAX: 252-237-7726

E-mail: sales@lelyus.com

— leaders in wastehandling —
www.lelyus.com

800-334-2763

Get More Income with Every Tank Pumped!

With

PRO-PUMP®

The Finest Name in Biological Products for Septic Systems, System Recovery, Odor Elimination and More...

Introducing New PRO-PUMP®/SEPTIC SAVER!



SEPTIC SAVER

PRO-PUMP®/SEPTIC SAVER is a combo pack of our two best selling septic treatments: PRO-PUMP®/HC & SP packets, bundle packed as a monthly (12) treatment program.

- Septic System Treatment
- Absorption System Recovery
- Aerobic System Treatment
- Drain & Grease Traps
- Solids Reduction
- Odor Control
- Bio-remediation

The Best Microbial Technology Available Today!

The PRO-PUMP® biological series is designed to meet a wide range of on-site wastewater applications with unmatched performance!

Want to earn more income per truck per year? BECOME A PRO-PUMP® DISTRIBUTOR!

Professional Sales Materials & Technical Support at No Charge!

We provide technical support, combined with informative sales and marketing materials, and we don't sell direct to the consumer! All web-based inquiries are sent to you!



Solving Problems, Naturally!
Ecological Laboratories INC.

CORPORATE OFFICES: 13 Hendrickson Ave., Lynbrook, NY 11563
TOLL FREE: 1-800-326-7867 • FAX: 516-823-3440 • EMAIL: info@propump.com

Visit our web site at: www.propump.com

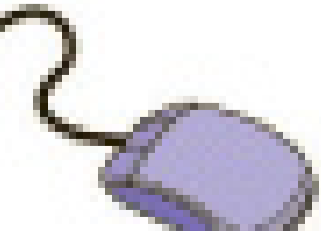

MADE IN THE U.S.A.

800-367-0972



PERFORMANCE

Since 1939

35 CFM

thru

180 CFM



**Conde' Power Packages
Right Angle (PTO) Packages
Pumps & Accessories**

DURABILITY

PRO-YAC

INDUSTRIAL PUMPOUT STATION



**THE ONE STOP SHOP
for the**

LIQUID WASTE INDUSTRY

Westmoor, Ltd

PO Box 99

Sherrill, NY 13461

www.westmoorltd.com

E-MAIL: pumps@westmoortltd.com

FAX: 315-363-0193

QUALITY

CALL-A-HEAD®

Trucks In Like New Condition

Call-A-Head Corporation takes delivery of a new Best Enterprises stainless steel truck every 4-weeks enabling us to maintain the newest fleet in the Industry throughout America, which in turn requires the resale of these spectacular stainless steel trucks at the end of their 3-year stay at the Call-A-Head Corporation. Call today and start building your company the way we did with the **Best**.

304 Crossbay Blvd.
Broad Channel, NY 11693

800.634.2085

Fax: 800.634.8127

www.callahead.com



2006 Ford F550 Super Duty Pump Truck

Turbo Diesel, White/Gray interior. Like our entire fleet this truck is built by **Best Enterprises** in Arkansas all stainless steel. Tank is 1050 total gallons with 350 gallons being fresh water. This perfect truck is priced right at **\$48,240**

2005 Ford F550 Diesel Tank Truck

White with gray stainless steel tank, tool box, and bucket holders. 100' of green EPDM hose with all Highway mileage. Wholesaled at **\$38,500**

2005 Best Stainless Steel Tank Truck

With 700 waste and 350 fresh water, mounted on a reliable Ford F550 diesel cab & chassis. This perfect white with gray truck has a Masport PTO driven pump and a stainless tool box. Great buy at **\$38,900**

2004 Ford Super Duty Pump Truck

Turbo Diesel, White with gray Masport PTO driven pump. Stainless steel tank with 700 waste and 350 fresh water. Built by **Best Enterprises** in Arkansas. All of our trucks are maintained monthly by our authorized Technicians and are in brand new conditions at low prices. Buy this fine example at **\$35,458**

SOLUTIONS
SALES • RENTALS • PARTS • SERVICE

Jetstream
Subsidiary of Federal Signal Corporation

Waterblaster Rentals

- 170 hp - 300 hp units available
- Convertible from 10k to 20k to 40k PSI pressures
- Two convenient locations
- Parts and accessories also available
- Pickup or delivered
- Operator training
- Rent to own

We've got you covered



West Coast (Long Beach, CA)

1-866-515-9891

Midwest (Toledo, OH)

1-888-415-RENT (7368)

www.fssolutionsgroup.com • rentalsfssolutionsgr@federalsignal.com

PT & E

PRECISION TANK & EQUIPMENT CO.

www.precisiontank.com | 1.800.258.4197

CENTRAL ILLINOIS Manufacturer Celebrating 40 years of steel and stainless steel tank equipment innovations. Tank sizes from 100 to 5000 gallons in stainless steel or steel.

Manufacturing plants in Virginia and Athens, Illinois bringing quick completion of your pumper truck!

40 years of excellence!

PRECISION TANK & EQUIPMENT CO.



Standard models or custom built units

Single or multiple compartments

1.800.258.4197

 **Juggler™**

The **ONLY**  **CERTIFIED,**

solid-liquid separator for grease traps
and septic tanks that's **SMARTER** and **GREENER**
than a standard Pumper truck!



 **labrie**
environmental group

ISO
9001
CERTIFIED
(2000)

Contact Robert Lamarche at ☎ 1 514 919-0347
New video at www.labriegrup.com

☎ 1 800 463-6638 | www.labriegrup.com



EXPLORER

SANITATION & RECYCLING

The Standard In Portable Toilet Transportation!

Ask about Hot Dip Galvanizing!

*Adjustable skids
to fit a wide
range of toilets!*

*Low pro design
for easy loading!*

Distribution Centers

California	Colorado	Texas	Florida	Alberta
Plumas Sanition Tel: (530) 832-0370 Fax: (530) 832-0373 Portola CA	Columbia Sanitary Tel: (303) 526-5370 Fax: (303) 526-9586 Golden CO	Woyt Enterprises Tel: (903) 586-6493 Fax: (903) 541-0874 Jacksonville TX	Steve Baie Enterprises Tel: (407) 709-8175 Fax: (407) 822-3998 Apopka FL	Ted Hoover Tel: (403) 946-4108 Crossfield AB

Contact your local distributor
or the manufacturer

Toll Free 1-866-457-5425
fax 519-669-8331

email: info@mckee technologies.com

Manufactured by: McKEE TECHNOLOGIES INC. ELMIRA, ONTARIO, CANADA N3B 2Z7

Dewatering Equipment



**Use The Right Equipment
To Get The Best Results.**

Liquid Reduction = Reduced Transportation Costs
Dewatering = Reduced Tipping Fees
Non-Organic Separation = Facilitate Land Application of Liquids

ACCENT
MANUFACTURING INC.

Designed for Simplicity. Engineered for Durability.

Toll Free: 877.855.4890

info@accentmanufacturing.com • www.accentmanufacturing.com

FACTORY AUTHORIZED SERVICE

for: *ROOTS-DRESSER, ROBUSCHI, HIBON, H&H,
HOLMES and KAISER Blowers*

**Fast Delivery - Large Selection - Best Price - Great Service
New - Rebuilt - Core Exchange**

**Exchange Units - Most Models
of Roots, Robuschi, Hibon,
Holmes, H&H and Kaiser**

- ◆ Roots 1125 Trinidad
- ◆ Roots 1021 DVJ
- ◆ Roots 1024 RAS
- ◆ Roots 1021 RAS
- ◆ Roots 824 RCS
- ◆ Hibon SIAV 840
- ◆ Hibon SIAV 8702
- ◆ Hick Hargreaves 4084

**New Blowers & Pumps
Available From POWER VAC**

- ◆ Roots
- ◆ Robuschi
- ◆ Hibon
- ◆ Hick
- ◆ Masport
- ◆ Moro
- ◆ Aerzen

DRESSER ROOTS

hibon KAISER

ROBUSCHI

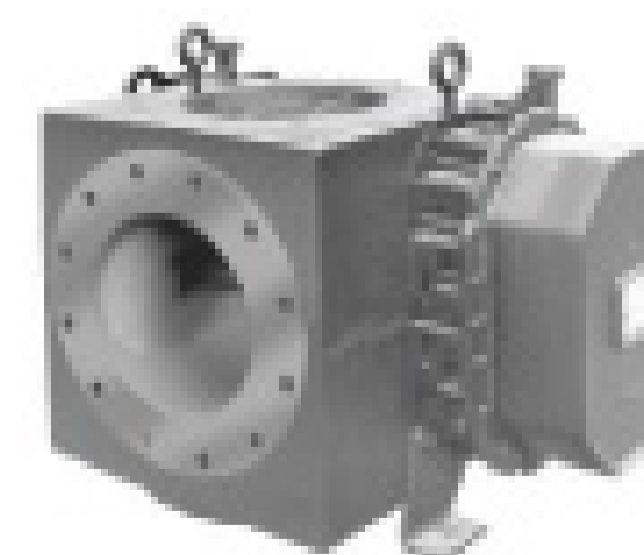

POWER VAC
INCORPORATED

1-800-822-4887

W228 N2792 Duplainville Rd. • Unit G. • Waukesha, WI 53186
(262) 542-8989 • Fax: (262) 542-6262 • www.powervacinc.com

**ALUMINUM, STEEL and
STAINLESS TANKS manufactured,
assembled and serviced by quality
Imperial employees!**



**IMPERIAL
INDUSTRIES INC.
800-558-2945**

**WE DIDN'T JUST INHERIT THE NAME "IMPERIAL",
WE EARNED IT WITH "IMPERIAL" QUALITY/DESIGN/SERVICE**

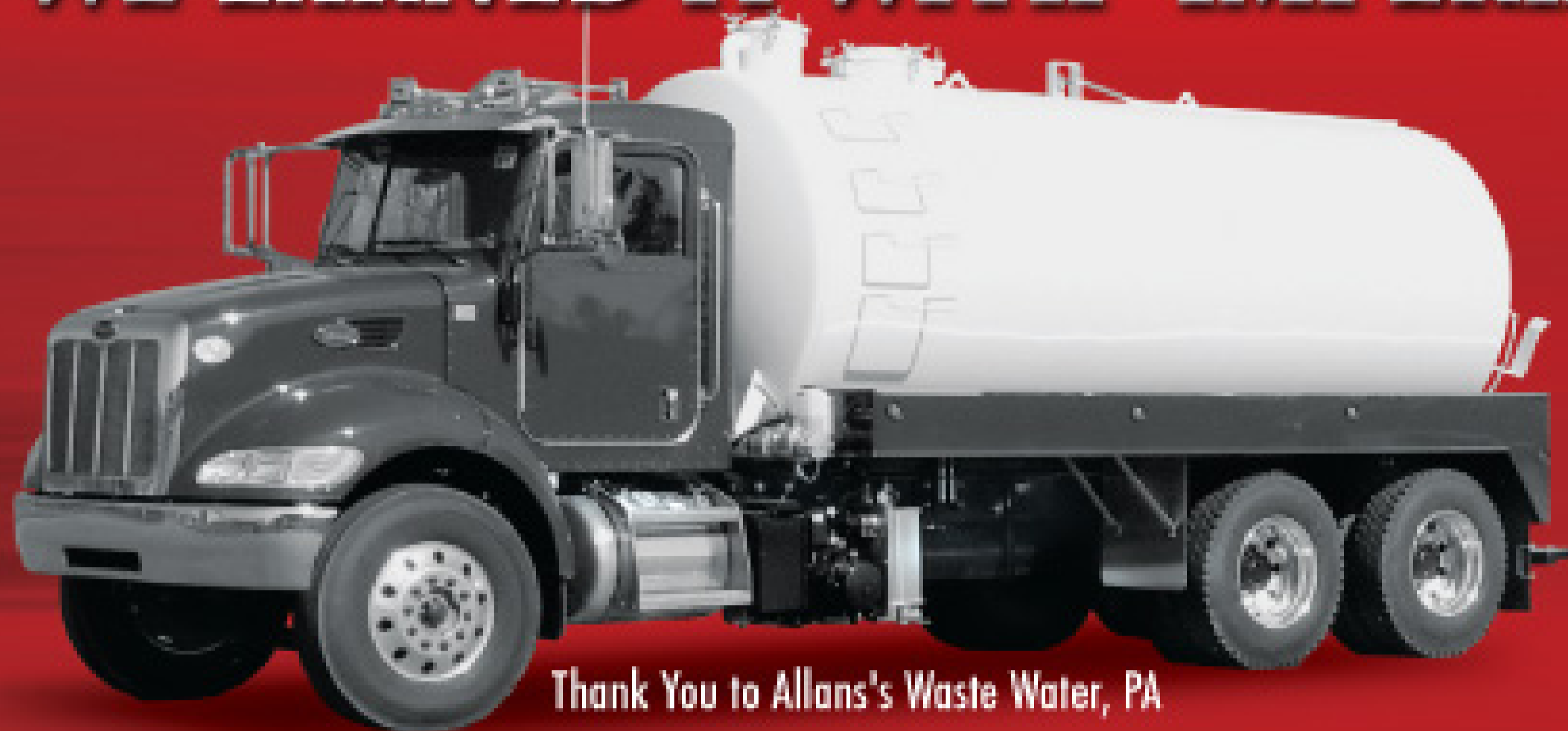

Thank You to Allans's Waste Water, PA



CUSTOM MANUFACTURED TANKS IN STEEL, ALUMINUM AND STAINLESS

- STOCK UNITS:**
- 2008 Sterling/3600 Gallon Steel Tank
 - 2008 I.H./3600 Gallon Steel Tank
 - Both Ready For Delivery (Call For Details)

- STOCK TANKS:**
- 2500 Gallon Steel & Aluminum
 - 3600 Gallon Steel & Aluminum
 - 4000 Gallon Aluminum
 - All Ready To Mount On The Chassis Of Your Selection

Call Jim Stieber or Brad Rybarczyk for details!

WE HAVE UNITS AND TANKS IN-STOCK TO MEET ALL YOUR PERSONAL NEEDS!

- 2008 F550/875 Gallon Steel Service Unit, \$58,856
- 2008 F550/1100 Gallon Aluminum Unit, \$61,854
- 2008 Fuso/1100 Gallon Aluminum Unit, \$62,701
- 2008 Dodge/700 Gallon Sidewinder/
Flat-Bed, \$60,944
- Slide-In Units in Steel/Aluminum
and Stainless in various capacities!



V&H AUTOMOTIVE
Marshfield, WI 54449
Randy Tischendorf

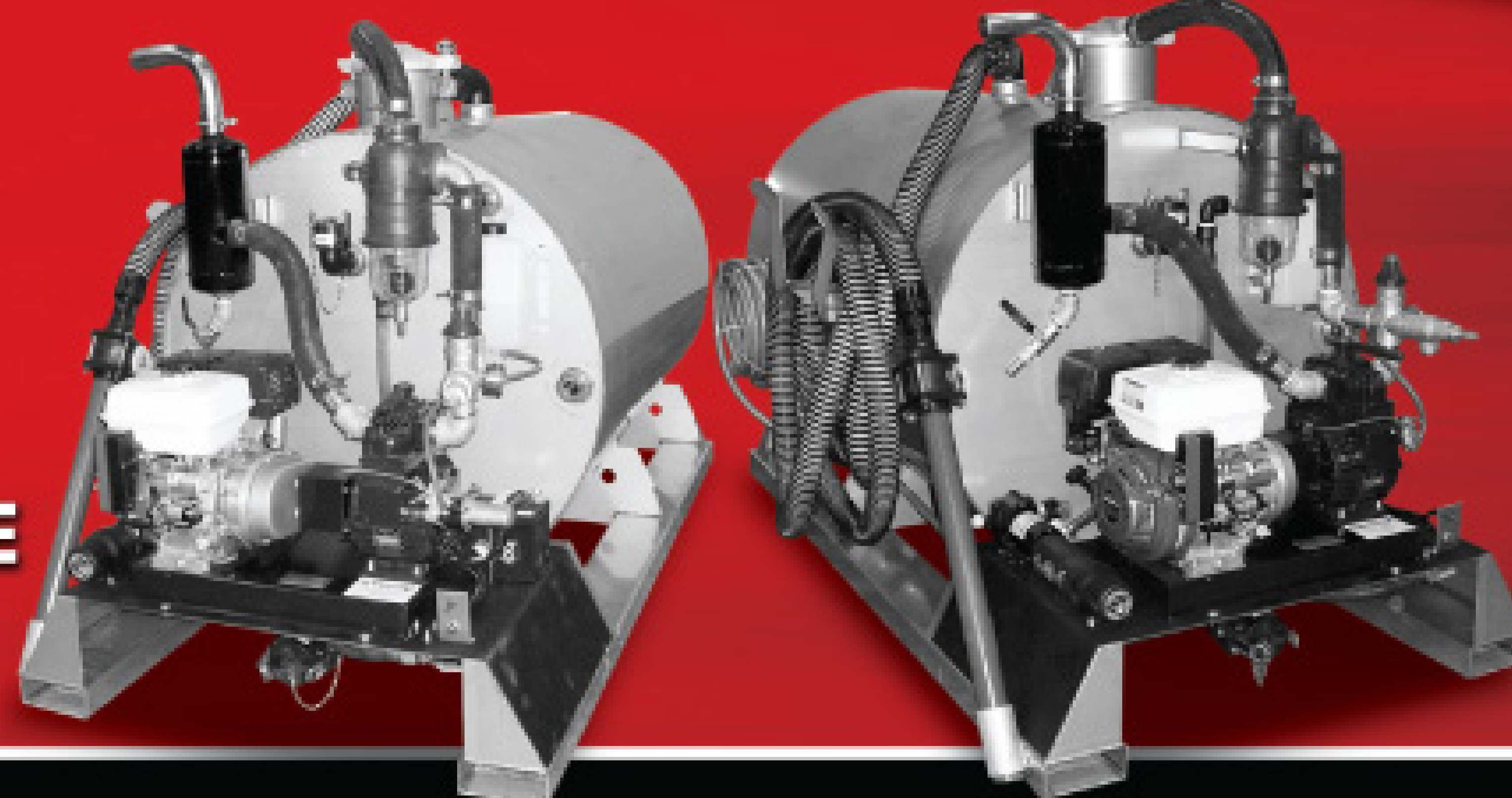

IMPERIAL
P.O. Box 1685 • Wausau, WI 54402
Tom Aerts

800-722-7382, ext. 244 | www.imperialind.com | 800-558-2945, ext. 317

On a jobsite in Hyannis, Mass., technician Paul Martin (left) and Bluewater CEO Dan Potter review paperwork. One of the company's Juggler trucks is in the background. (Photos by Jennifer Longley)



By Ken Wysocky

GREEN & Growing

For New England contractor Bluewater Septic, environmentally friendly processes point the way to business expansion

Profile

Bluewater Septic
Needham, Massachusetts

MASSACHUSETTS

Owners: Dan Potter and minority investors

Years in business: 1.5

Employees: 75

Specialties: Commercial and residential septic tank cleaning and drain cleaning

Service area: New England

Web site: www.bwseptic.com



Dan Potter has seen the future of the septic waste removal industry, and it's colored green — as in environmentally friendly.

In fact, Potter is so convinced of this eco-friendly trend that he's built environmental sensibilities into every aspect of his year-old business, starting with its name: Bluewater Septic, headquartered in Needham, Mass. Then there's the company's marketing slogan, "Smarter. Cleaner. Greener." And last but not least, consider its fleet of state-of-the-art Juggler water-recycling trucks, which perform onboard dewatering of septic and grease-trap waste.

"I'm very passionate about this," notes Potter, Bluewater's president and chief executive officer. "I've got four daughters, so I'm very concerned about the future of our environment. Being 'green' is good for the environment and it's the wave of the future for this industry."

"Our company is based on giving back to the environment," he continues. "A Juggler truck costs about twice as much as a conventional pumper truck, but they're green. And that's a whole lot more important."

Potter's green streak stems from his years growing up in Minnesota, aptly nicknamed the "Land of 10,000 Lakes."

"I see water as the ultimate commodity," Potter explains. "It's a precious resource. That's why this water-recycling technology is so great — we're talking about saving millions of gallons of water a year."

“YOU CAN CONTROL MORE SEPTIC TANKS, YOU CAN CONTROL MORE GREASE (TRAPS) AND YOU CAN OPTIMIZE ROUTES. YOU ALSO GET MORE NAME RECOGNITION — SIZE BUILDS ON SIZE — AS WELL AS BETTER DEALS ON HEALTHCARE BENEFITS AND OTHER PURCHASES. SURE, THERE ARE DISADVANTAGES TO BEING BIG, BUT WE HAVEN’T ENCOUNTERED THEM.”

Dan Potter

GROWTH SPURT

Bluewater owns almost two dozen Jugglers, made by Labrie Environmental Group, and will take delivery on a dozen more this summer. The trucks are the driving force behind the company’s aggressive plan to become the largest septic waste handler in New England. All the Jugglers currently owned are 2007 or 2008 models, most built out atop Freightliner 410s or 420s, Potter says.

The company also owns more than 30 2007 and 2008 Ford E-350 service vans, more than a dozen 2007 and 2008 Ford F-150, F-250 or F-350 pickup trucks, three 9,000-gallon Sterling tanker trucks and a half dozen backhoes.

“We’ve made about a dozen acquisitions in the past year and a half, and currently service customers in six New England states: Connecticut, Maine, Massachusetts, New Hampshire, Rhode Island and Vermont,” Potter says. “In 2008, we plan to move into the Mid-Atlantic States — Virginia, North and South Carolina and the Washington, D.C., area — as well as Florida.

“We’re a full-service operation — everything from soup to nuts,” he adds. “Our primary focus is commercial and residential septic waste and drain cleaning, but we also do everything from confined-space and Vactor truck work to sewer jetting and cleaning grease traps.”

A former real estate development investor, Potter was introduced to the septic waste

industry when his attorney told him about a business opportunity on the East Coast. Potter liked what he saw.

“So I said, ‘Let’s raise some money and start buying up some companies and invest in equipment,’” he recalls. “We knew that we wanted to get bigger, and that we could do it quicker with an investment group.”

GAINING MOMENTUM

For acquisitions, Bluewater targets companies that make sense geographically — in other words, the East Coast — and that enjoy good cash flow.

“We’re not interested in companies that are just asset heavy — got a lot of trucks, but they aren’t moving,” he explains.

Is bigger better? Potter believes so.

“You can control more septic tanks, you can control more grease (traps) and you can optimize routes,” Potter notes. “You also get more name recognition — size builds on size — as well as better deals on healthcare benefits and other purchases. Sure, there are disadvantages to being big, but we haven’t encountered them.”

Size is allowing Bluewater to tap a growing trend in the industry: obtaining contracts with municipalities to perform regularly scheduled service for things such as septic tanks or grease



Account manager John Laliberte (right) and Dan Potter review a GPS map showing Cape Cod in the company’s Yarmouth, Mass., office. The technology constantly tracks service vehicle locations.

traps within its boundaries.

“This is a common and accepted practice in Canada, and it’s the way the industry is going to go here, too,” Potter asserts. “For municipalities, using a ‘one-stop shop’ means less administrative costs, plus regular cleaning of grease traps reduces the chances for clogged sewer lines.

“Also, through Global Positioning System data, we can provide an auditable trail to prove to the municipality that we did the work. Otherwise, companies say the tanks were serviced, but the municipality doesn’t know for sure.”

Bluewater’s bigger-is-better philosophy doesn’t mean Potter has no empathy for smaller mom-and-pop operations, he emphasizes.

GOING FOR THE JUGGLER

The Jugglers play a critical role in Bluewater’s growth plans. As the focal point of the company’s marketing efforts, the gleaming machines are featured prominently on the company’s Web site and all its direct-mail promotional materials, Potter notes.

During the pumping process, the Juggler filters out solid waste and returns water to the tank — water that includes bacteria that helps break down waste. The upshot is three-fold, according to Potter: the tank retains its ability to break down waste, the trucks don’t dispose as much water at treatment plants, and technicians can make more service calls per day.

In instances when water infiltration during pumping prohibits returning the filtered water, Bluewater disposes of the water at the plant like a traditional pumping job.

What do customers think of the Jugglers?

“The customer response has been tremendous,” he says. “They’re truly embracing this technology. The bottom line is if you can service septic tanks and do something for the environment at the same cost as before, then it’s a win-win proposition for customers.”



At the Yarmouth, Mass., regional office, Juggler trucks are lined up and ready to go. Potter says the trucks have an eco-friendly appeal when used to clean septic systems and restaurant grease traps.



Above, technician Paul Martin jets a septic system at a residence in Hyannis, Mass. At right, Martin hooks up a hose to the Juggler truck before pumping a septic system.

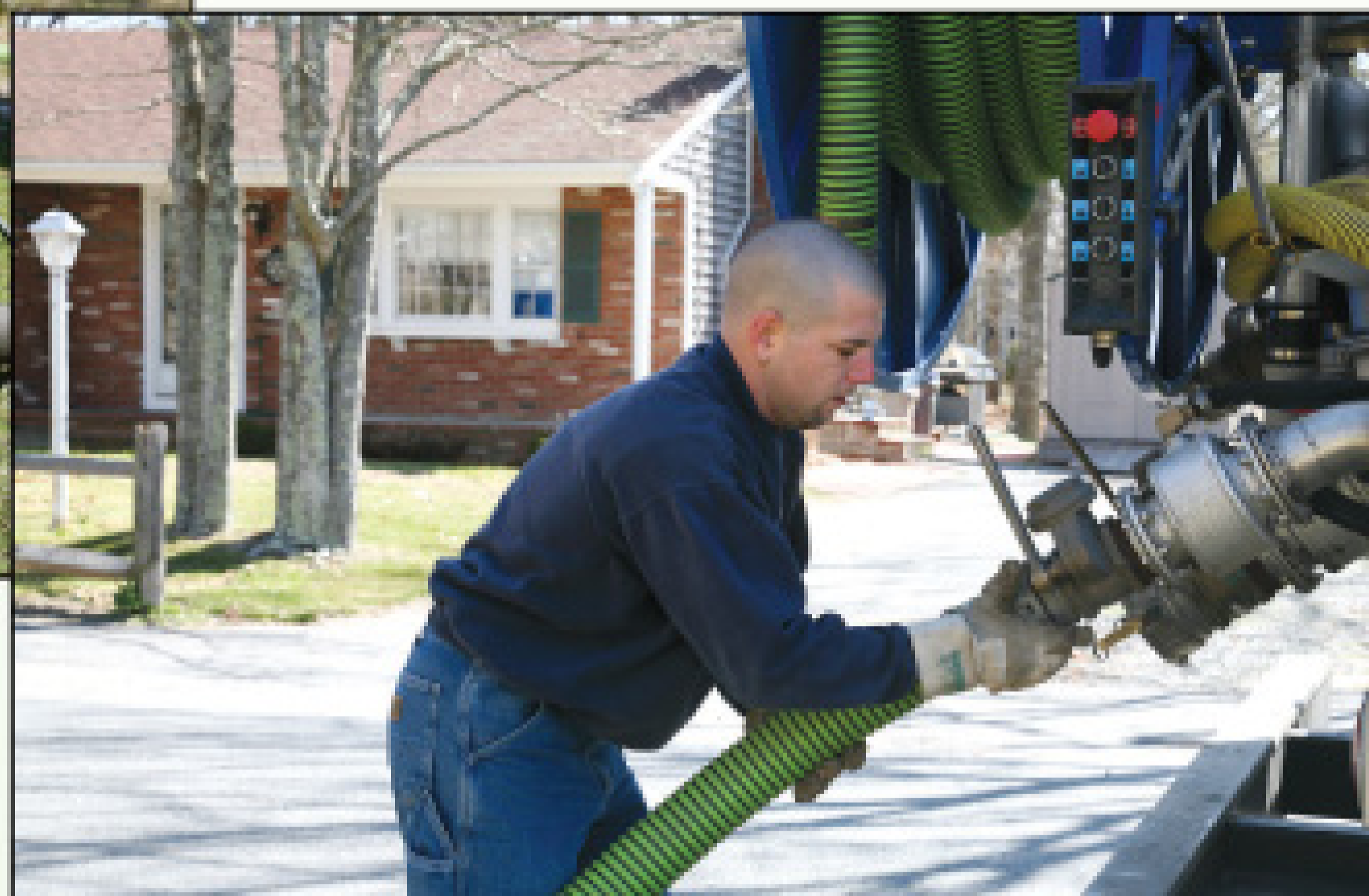

“IF WE CAN PROVIDE GOOD SERVICE TO CUSTOMERS AT A FAIR PRICE, AND AT THE SAME TIME HELP THE ENVIRONMENT BY USING LESS WATER AND LESS GASOLINE, AND MULTIPLY ALL THOSE BENEFITS AS OUR BUSINESS GROWS, THEN IT’S A WIN-WIN-WIN SITUATION.”

Dan Potter

TECH TALK

Bluewater also saves money by investing in high-tech equipment, like GPS units on all its trucks and a state-of-the-art dispatch center. The system allows the company to route trucks in the most efficient manner possible.

“It’s just like an air-traffic control center,” Potter says. “A 50-inch

Potter first saw the Juggler truck two years ago at the Pumper & Cleaner Environmental Expo International, and thought it would revolutionize the industry.

“The price scares a lot of people off, but I decided to jump on the opportunity,” he notes.

“Now, when we buy a new company, we ‘Jugglerize’ it — sell all the old trucks and buy new ones.”

The Jugglers require some special operational and maintenance training, Potter says.

“Specific maintenance differences (compared to a traditional vacuum service truck) revolve around the components that make the Juggler a Juggler, such as the self-cleaning filter system or routine greasing at the pivot points of the rear reel option,” he says.

television screen shows us exactly where all the trucks are. So if we need a truck to respond quickly to a certain area, we can see that, say, truck No. 15 is nearby and will be off its job in 15 minutes. So we’ll send that truck to handle the emergency call. It’s just smart management.”

Every route driver also has a cell phone, and drivers are notified about route changes via text messages. Then the driver uses his GPS unit to determine the best way to get to the new destination.

Bluewater also runs a sophisticated marketing program emphasizing its eco-friendly approach to waste management. When Bluewater acquires a company, it sends out a direct-mail brochure to all existing customers. It also buys lists with the names of prospective customers in that ZIP code and contacts them via direct mail.

“We also have a sales staff that calls on large corporate accounts,” Potter adds. “They’re all embracing the ‘green’ technology. If you’re a restaurant, you want to be ‘green.’ If you’re Wal-Mart, you want to be ‘green.’ When they see that they can be green for the same cost, they’re all over it — they love it. It’s a no-brainer from a business standpoint.”

Potter says Bluewater’s goal is give customers no excuse not to use its services.

“If we can provide good service to customers at a fair price, and at the same time help the environment by using less water and less gasoline, and multiply all those benefits as our business grows, then

it’s a win-win-win situation,” he says. ■

Benefits program attracts quality workers, boosts customer service

High-tech equipment isn’t much use if you can’t attract and retain quality employees to operate it. Bluewater Septic in Needham, Mass., solves that dilemma by offering its employees a top-tier benefit program, explains Dan Potter, president and chief executive officer.

“I like to give people a career opportunity, not just a job,” he emphasizes. “We offer the best benefit package in the industry, but the best thing our employees have is opportunity.”

As an example, Potter points to Bluewater’s recent acquisition of a company on Cape Cod. One of the employees of that company is now running that operation for Bluewater.

“Is everyone going to be able to do that? Probably not,” Potter admits. “But at least there’s an opportunity to do so.”

Potter believes Bluewater pays better than competitive wages for the region. The company also pays 80 percent of the cost of employee health insurance and offers a 401(k) retirement plan and paid vacation.

Providing great benefits for employees also leads to better customer service, Potter asserts.

“Our benefits allow us to pick from the cream of the crop of septic drivers,” he concludes. “It’s no different than a sports team that can pay more and attract better talent.”

SAVINGS AT THE DUMP

So how can Bluewater afford to make such large capital expenditures while still charging the same pre-acquisition prices?

“We don’t have to charge more. We make it up on volume,” Potter explains. “Plus, we save quite a bit on dumping fees by not disposing all the water a conventional truck would be carrying.

“Say, for example, that you’re paying 10 cents a gallon to empty your tank,” he continues. “If you service 20,000 gallons a day, but return 12,000 gallons back into the septic tanks, then you’re only paying to dump 8,000 gallons a day.”

Moreover, technicians can make eight or nine service calls a day as opposed to two or three, and make less frequent trips to the treatment plant, which saves gasoline and minimizes the time trucks spend on the road, which reduces emissions.

“A treatment plant can easily tie up a truck for an hour, and you’re burning fuel while waiting in line,” Potter says.

MORE INFO:

Labrie Environmental Group/Juggler
800/463-6638
www.labriegrup.com



Our **VALUE** goes deeper than you realize.

When it comes to portable sanitation solutions, WALEX delivers much more than blue deodorizers and accessories. We're giving you **innovative research & development** that has set all the current standards for excellence. You're getting **proprietary breakthroughs** that our competitors can only emulate. When you choose WALEX, you're not only getting **the best on the market today** — *you're also supporting your industry's future.*



For more information, contact us at **910.371.2242**, toll-free **800.338.3155**
or visit our website at **www.walex.com**.



CAPITAL RUBBER CORP



4TH OF JULY SPECIAL

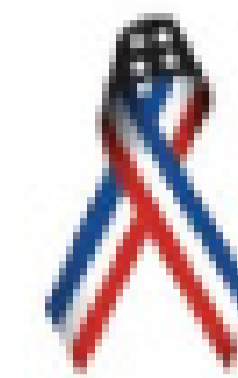

HELP SUPPORT OUR TROOPS

A PORTION OF PROCEEDS FROM ALL ORDERS PLACED IN JUNE AND JULY WILL BE DONATED TO OPERATION SUPPORT OUR TROOPS, AN ORGANIZATION COMMITTED TO SENDING CARE PACKAGES TO AMERICAN SOLDIERS OVERSEAS AND AIDING WOUNDED SOLDIERS AND THEIR FAMILIES

**\$10 OFF ALL
BUMBLEBEE HOSE
ASSEMBLIES**



POWER BOOSTER

**INCREASE VERTICAL LIFT
SAVE TIME ON DIFFICULT JOBS**



**FREE 50 FT AIR HOSE WITH
POWER BOOSTER PURCHASE!**

EPDM WEATHERFLEX SUCTION HOSE SPECIAL

3" X 25 FT: 1 FOR \$99, OR 4 FOR \$385

3" X 33 FT: 1 FOR \$125, OR 3 FOR \$366

COUPLINGS INCLUDED!

- SHIPPING ADDITIONAL -



INFO@CAPITALRUBBERCORP.COM

(800) 258-3000

WWW.CAPITALRUBBERCORP.COM



Has your current paper products supplier
let you down?

We carry a complete line of paper products and chemicals for the portable toilet/septic industry.

CALL TODAY!



Serviceing the Industry with Pride Since 1994

250 Old Mariton Pike • Medford, New Jersey 08055
609-714-2424 • Fax: 609-714-3030 • 800-699-9903 • www.delvel.com

CLEAR COMPUTING *with* INSIGHT

Total Activity Control Street Eagle GPS

Reduce Operating Expenses

Your company can be more profitable in any economy!
Call today and learn how!

- Profit by Work-Order
- In-Vehicle Garmin Updates
- GPS Vehicle Tracking
- FREE Imports

1988 - 2008

20

YEARS OF
EXCELLENCE



Try it Yourself Free...
On the Web or Your PC.

Clear Computing
(888) 332-5327
www.clearcomputing.com

Insight USA
(301) 866-1990 x201
www.mds-inc.com

VACUTRUX



Industrial vac



Supertrux



Septic pumper



Routetrux



Industrial vac

**Call today to discuss your
equipment needs!**



Maxitrux



**Phone
(800)-305-4305**

53 ARTHUR ST. ELMIRA, ONTARIO, N3B 2Z7 fax (519) 669-8331 salesinfo@vacutrux.com

This is your Black Tie Manufacturing Trailer



This is your trailer ON RENT to Black Tie Event Services



ANY QUESTIONS?

Just **ASK** these companies how much they enjoyed *spending the money they made* through the **Black Tie Re-Rental Program**.

Mr. John - NJ • Potty Queen - PA • B & S Port-O-Jons - TX

We would like to welcome our newest members to our re-rental network:

Aparo's Little John, Liberty Waste Management, Room To Go, Sarnia Sanitation, Almost Like Home, Jay's Septic Tank Service, and D. J. Bass, Inc. / Elegant Restrooms.



The Elegant Mobile Restroom Company

877-733-1200

[www. BLACKTIESERVICES.com](http://www.BLACKTIESERVICES.com)

TEN YEARS of rental and operating experience
are built into every Black Tie Trailer design!

Experience the Black Tie Difference!



Metered Fixtures

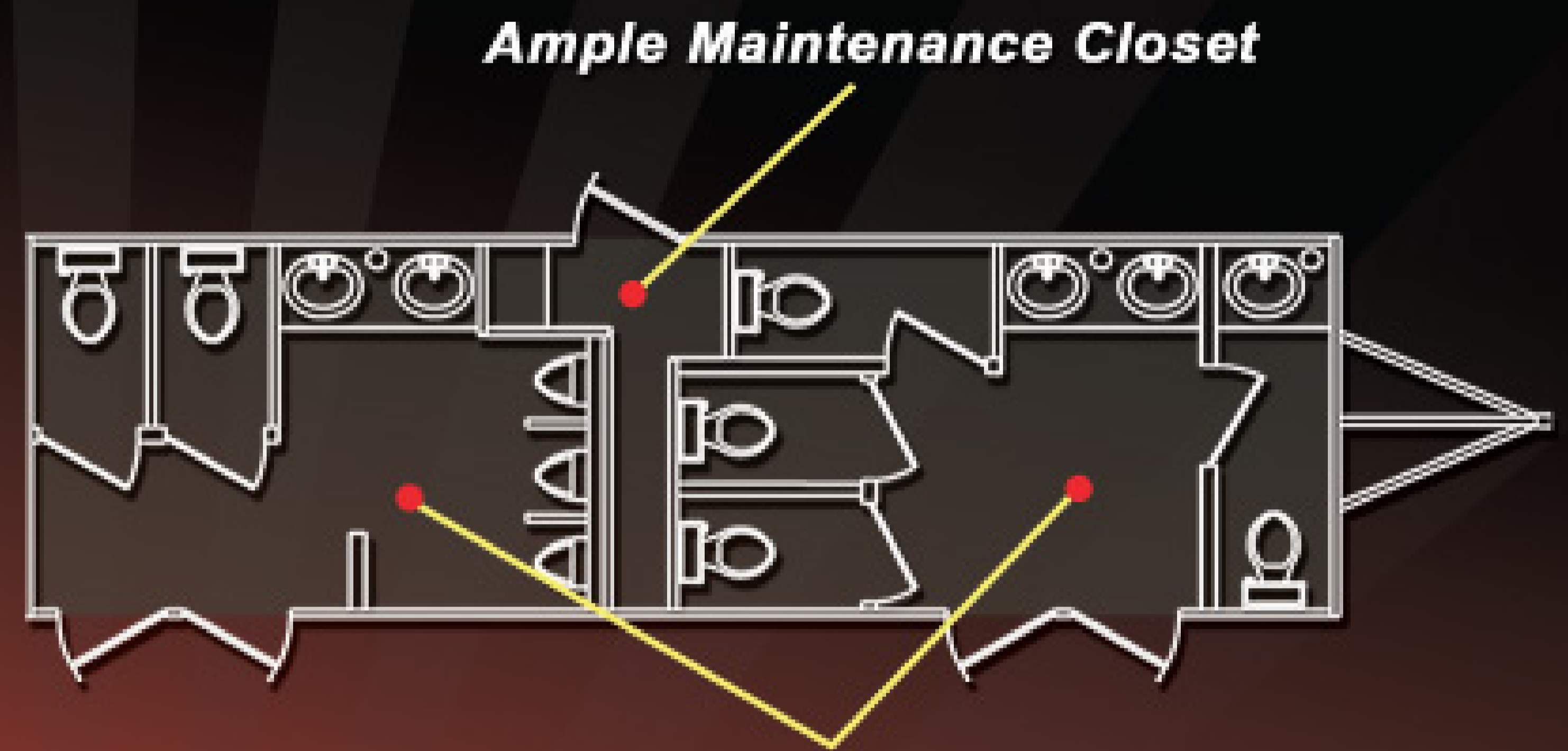

Ample Maintenance Closet

Maximized Traffic Area

**Easily Accessible
Clean-outs
on Waste Tank**

**Seamless Pitched Roof Design
Prevents Water Leakage**



**Spare Tire
Standard**

**Triple Axles Standard
on 28 foot Models**

- All floor plans available with onboard freshwater.

Let our experience help to create a custom trailer for you!



Mobile Restrooms and Showers

www.BLACKTIEMANUFACTURING.com

Call
toll free **877-253-3533**
Attractive Financing Programs Available



CIRCLE D TRUCK SALES

www.circledtruck.com

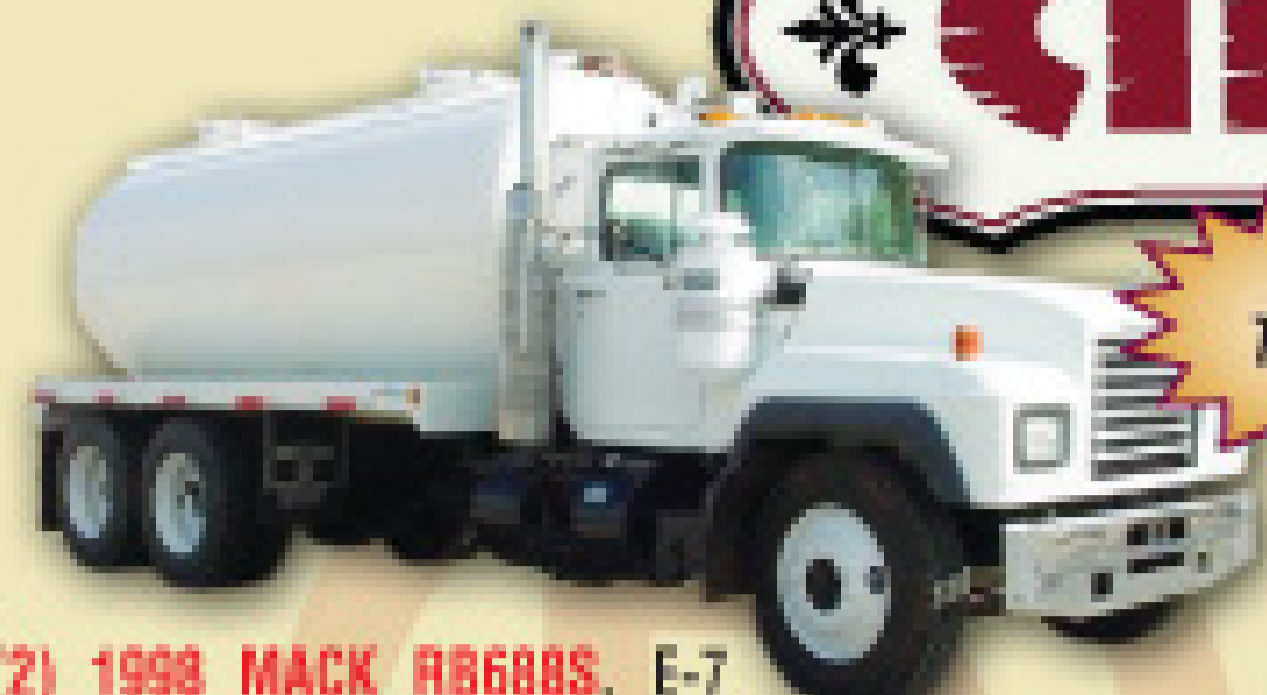

NEW TANK

(2) 1998 MACK RB688S, E-7
Mack 350 HP, 9 Speed, Engine Brake, Camelback Suspension, 4.64 Ratio, 190" WB, 24.5 Tires, Aluminum / Steel Wheels, Tandem Axle, 12,000# FA, 38,000# RA, HD frame, AM/FM Stereo, P/S, A/C, New Chrome Bumper, (2) 80 Gallon Aluminum Fuel Tanks, Detailed And Serviced, New White Paint. "NEW" 2007 Bulldog Vacuum Tanks, 3,360 Gallons (80bbl), 1/4" Head & Shell Thickness, Primary & Secondary Shutoff, (2) Top Man Ways, (1) Rear Clean Out, (2) Internal Baffles, Sump With (2) 4" Rear Outlets With Water Style Butterfly Valves, Front Sight Glass, Vacuum & Pressure Relief Valves, Full Length Hose Trays, Rear Bumper, Jurop R260 Vacuum / Pressure Pump With Pump Stand And Right Angle Drive. Stk. #1487 **\$74,500 each**



VERY NICE!

2001 MACK CX613 VISION, E7-427 Mack, 10 Speed Autoshift, Engine Brake, Air Ride Suspension, 3.70 Ratio, 220" WB, 22.5LP Tires, All Steel Wheels, Tandem Axle, 500-600K Miles, Tilt, Cruise, AM/FM Stereo, Fleet Maintained, (2) 145 gal Aluminum Fuel Tanks, "NEW" 2007 Bulldog Full Tilt Vacuum Tank Hydraulic driven, Controls on driver side, 3,360 Gallons (80bbl), 1/4" Head & Shell Thickness, Primary & Secondary Shutoff, (2) Top Man Ways, (1) Rear oversized Clean Out air operated, (2) Internal Baffles, Sump With (2) 4" Rear Outlets With Water Style Butterfly Valves, Front Sight Glass, Vacuum & Pressure Relief Valves, Full Length Hose Trays, Rear Bumper, Jurop R260 Vacuum / Pressure Pump Hydraulic driven fan cooled. Stk #1790 **\$89,500**



VERY NICE!

2002 MACK CX613 VISION, AC-460 Mack, 10 Speed, Engine Brake, 40,000lb RA, 12,000lb FA, Mack Air ride Suspension, 3.90 Ratio, 11R22.5 Tires, Aluminum front Wheels, Chrome exhaust, Tilt, Cruise, AM/FM Stereo, AC, PS, Heated mirrors, Visor, Fleet Maintained, (2) 90gal. Aluminum Fuel Tanks, Super Nice!!! "NEW" Presvac DOT-MC MC 412, 3150 Gallon, Tilt With Full Open Rear Head, 4" Load Line With Riser, 6" Discharge, Catwalk With Handrails, Fruitland RCF 500 Vacuum Pump. **128,000**



IN STOCK

NEW 2008 1308BL, (5460GL.) DOT 407/412 ASME VACUUM TRAILER,
Spring suspension, 11R24.5 tires, Full length walkway with handrails, (2) - 4" butterfly valves with air to open spring to close at rear, (3) - 20" diameter DOT certified National Vacuum domed man-ways, (1) 20" diameter DOT certified National Vacuum domed man-way located on lower rear head, 12" Heavy duty DOT internal shut-off at top front of tank, Outside scrubber with dome lid and 2" drain, Girard 3" relief valve, Front, center, and rear overturn protection, External arrow rotary float gauge with 8" stainless steel float ball, 18" x 18" x 36" toolbox with locking latch (2) work lights with on/off switch located at rear. **\$54,750**

Available Soon: 1992 Volvo w/Vactor unit, good spec's, being refurbished - Call for price!

MORE TRUCKS AND TRAILERS AVAILABLE, IF WE DON'T HAVE IT WE'LL FIND IT!

Lee Dill, Richard Roberts, John Trammell, Gary Chandler
CIRCLE D. TRUCK SALES

4502 E. OVERLAND TRAIL • ABILENE, TX • 79601
325-677-0474 • FAX: 325-673-7207

888-433-0474



READY TO HAUL

2008 TIGER 1308BL, VACUUM TRAILER, non-code, 4 Spring Suspension, Steel Composition, 24.5 Tires, All Steel Wheels, Tandem Axle, Steel Composition, 5460 Gallons, 1 Compartments, Full length walkway with Tool box, (2) 4" butterfly valves, scrubbers, Full length hose trays. Ready to haul!!! **\$37,950**

Big Fish ENVIRONMENTAL

Receiving & Processing
For
**Septage • Biosolids,
Fats, Oil & Grease**
Design • Build

P.O. Box 528 • 12608 Taylor Rd.
Charlevoix, MI 49720

PH: 231.547.4429 • FAX: 231.547.2057

www.bigfishenvironmental.com

CADMAN / ALBERS

For Emergency or Temporary Storage of Liquids



- Safe, affordable enclosed storage.

- Up to 1.3 million U.S. gallons of capacity.



- Various agitator options.

- Neighbor friendly odor control.

- Blends in with the surroundings.

We also offer fully portable, transportable systems. Your containment solution is only a phone call away.

Cadman
POWER EQUIPMENT
AGRICULTURAL MACHINERY
& IRRIGATION EQUIPMENT



38 Main St. • Courtland, Ontario, Canada

1-866-422-3626

www.cadmanpower.com



VAC-CON

PRE-OWNED EQUIPMENT

MORE POWER TO YOU



2004 VAC-CON V390LHAD

- 2004 IH 7400
- IH 275 HP / Allison MD3060
- 60 @ 3000 / DEUTZ 138 HP
- Mileage: 35,500

RECONDITIONED **\$185,000**



1997 VAC-CON V312THAE/1300

- Ford LNT8000 / 275HP / MD3060
- 50 @ 3000 Water Pump
- Mileage: 66,703

RECONDITIONED **\$135,000**



2004 VAC-CON V390LHAD

- 2004 International 7400
- IH 275 HP / Allison MD3060
- 50 @ 3000 / DEUTZ 138 HP
- Mileage: 11,000

RECONDITIONED **\$198,500**



1998 VAC-CON VPD3612LHA

- 1999 IH 2554
- 275 HP / Allison MD3060
- 80 GPM @ 2000 PSI
- Mileage: 116,000

\$130,000



2000 VAC-CON V312LHA

- 2001 IH 2554
- IH 275 HP / Allison MD3060
- 50 @ 3000 / Cummins 110 HP
- Mileage: 122,800

RECONDITIONED **\$135,000**



2003 VAC-CON V311LHAD

- 2002 Sterling LT7501
- CAT 275 HP / Allison MD3060
- 60 @ 3000 / Cummins 130 HP
- Mileage: 69,700

RECONDITIONED **\$185,000**



2001 VAC-CON V312LHAD/1300

- 2001 Sterling LT9501
- CAT 380 HP / 10-Speed
- 80 @ 2000 / Cummins 110 HP
- Mileage: 73,000

RECONDITIONED **\$185,000**



1997 VAC-CON V316THA/1300

- 1996 FORD LTS9000
- 300 HP CAT / 10 SPEED
- 80 @ 2000 / John Deere 4045T
- Mileage: 78,500

RECONDITIONED **\$140,000**



www.vac-con.com



Ultimate Lease Hotline:
888-817.1757

969 Hall Park Drive • Green Cove Springs, FL 32043 U.S.A.
Tel: 904-284-4200 • Fax: 904-284-3305
www.vac-con.com • vns@vac-con.com

You Can't Buy A Better Reel.

Hose Reels for Cleaning and Pumping

- ✓ High pressure washing and cleaning
- ✓ Sewer, septic, portable toilet cleaning
- ✓ Video pipeline inspection
- ✓ OE vehicles and aftermarket upgrades
- ✓ Extra rugged, long-lasting design
- ✓ Complete custom capabilities



Download or call for your FREE Guide to Ordering Pumper/Cleaner Reels
<http://go.hannay.com/U16>
877-467-3357

Hannay Reels®
The reel leader.

Quality People Doing Quality Work

Industrial Vacuum Units

DOT Code & Non Code Vacuum Trailers



Vacuum Septic Units

Aluminum or Steel Tanks in a Variety of Capacities



Portable Restroom Service Units

*IN STOCK - 650/300 gal.
 Call for Details
 Ready for Immediate
 Delivery -
 Priced at
 \$56,147*



Mini Vac Trailers

*DOT
 Code &
 Non
 Code*



Slide-In Units



*IN STOCK - Slide-In Portable
 Restroom Units - Call for Details
 Industrial Skid-Mounted Units
 Also Available*

Marsh

INDUSTRIAL

P.O. Box 1107 - 135 E Mile Road - Kalkaska, MI 49646
 p: 231.258.4870 - f: 231.258.2019 - sales@marshind.com

800.952.1537 - WWW.MARSHIND.COM



48 YEARS OF DEPENDABILITY

TUFF-JON

- One-Piece Construction
- Lightweight
- Rust-Free Hardware
- Wood and Poly Skids
- Large Variety of Colors



Tanks in 60, 105, 225, 300 and 440 Gallon Sizes



Tuff-Jon III



90 Gallon Free-Standing Sink



60 Gallon Rinse Tank

— OPTIONAL ACCESSORIES —



7-1/2 Gallon Handwasher



Tuff-Jon with Lifting Bracket Assembly



Urinal



Paper Dispenser



Sky Heater



Exceptionally Strong Tank Design

The TSF Company Inc. | 2930 S St. Phillips Rd. | Evansville, IN 47712

Toll Free: **1-800-843-9286** | **812-985-2630** | Fax: **812-985-3671**

E-mail: **tsftuffjon@sbcglobal.net** | Web Site: **www.tuff-jon.com**



PORTABLE TOILETS | CHEMICAL TOILETS | HOLDING TANKS | HAND WASH UNITS



Omnivore™ X2 2-Stage Grinder

Unleash the power and reliability of the OmnivoreX2 with patented V-Slice™ cutter technology.

Now in a high-head, 2-stage design.

- Robust curve and head pressure allow for installation where progressive cavity style pumps have traditionally been installed.
- High-head performance to 185' max. TDH.
- Improved flow.
- Better cutting and macerating.
- Complete interchangeability with single stage Omnivore® units.
- Improved reliability.

Liberty Pumps®

800-543-2550

www.libertypumps.com

U.S. patent #7,159,806

Copyright © Liberty Pumps, Inc. 2008. All rights reserved.

**Inc.
5000**

One of America's fastest growing, privately owned companies.

LOCATE WITH THE BEST

WHETHER YOU ARE JUST GETTING STARTED OR YOU ARE AN OLD PRO, you can rely on Prototek for the best flushable transmitter and receiver systems in the industry. **FLUSH AND FIND** Locate underground nonmetallic tanks and lines with our orange AT-12 flushable transmitter and AR-1 receiver. Locate in cast iron or nonmetallic lines with our blue FT-8 flushable transmitter and FR-1 receiver. Recycle your used AT-12s or FT-8s back to us for credit toward your next purchase. Use your AR-1 for tracing metallic lines or utilities with Prototek's powerful and versatile **BuzzBox!** It operates at 223 KHz, 3 watts max power, in 3 ranges, Ground rod and cables included.



Prototek



ECONOMICAL • EASY **800-541-9123**

www.prototek.net email: prototeksales@prototek.net

SOFTWARE FOR THE INDUSTRY



GET A LIFE!

...with software that will get your life back!

Summit™ XP Service Profit Builder™

Work Orders
Job History
Reminders
Diagrams
Dispatching
Instant Mapping
Inventory Control
Receivables
Commissions
Repeat Business
QuickBooks® Link
...and much more!

Easiest to use!
...Over 25 years
experience

Let us transfer the data
from your old program!
Stay on Top...with Summit™!

Ask about our other software programs for:

- Portable restrooms & other rental businesses
- Sales contacts for sales personnel
- Employee incentive tracking
- Fleet maintenance and service tracking

DEMOS ON LINE!...or call for a Demo DVD or personal guided tour



Ritam Technologies, LP

Sales: USA 800-662-8471 • Int'l: 208-629-4462

Email: info@ritam.com • Web: www.ritam.com

ALUMATANK

4800 Gallon Septic Service

824 C.F.M. Moro Storm

2007 Sterling 9500 58,000 G.V.W.

410/450 H.P. – 10 speed transmission

\$132,800 Plus F.E.T.

Lease from **\$1,629** mo.



Pusher Axle Available

2000 Gallon Aluminum Tank

2000 gallon (2) compartment – 500/1500

Standard pumping system with Burks DC10 washdown

Masport HXL15 pump (350 C.F.M.)

Walkway to manhole on passenger side

Manway in rear head

Extra manway top waste compartment

Unit hauler & hitch

2008 4400 International

DT466, automatic transmission, hydraulic brakes

\$83,040 As Low As... \$1660 mo.



Refurbished Chassis...

NEW! Tank & Equipment...SAVE!

2001 Freightliner FLD112

ISM 330 H.P. Cummins – 9 speed transmission

200,000 Mile Power Train Warranty

New 3600 Gallon aluminum septic tank

Masport HXL400 water cooled pump

All standard features. *Large Tool Box.*



Looks & Operates Like New!

\$82,000

2000 Gallon Restroom Tank

Masport HXL4, Burks DC10, Hot shift PTO

Dual service – (2) reels

2008 Sterling – Acterra

26,000 G.V.W.,

Automatic trans.,

Air brakes.

\$81,177



As Low As... \$1623 mo.

L.C. TANKS

LaVerne Charlet



Toll-Free: **1-888-848-3727**

email: lctanks@bellsouth.net / fax: 270-898-4055

175 Cascade Drive, Paducah, KY 42003

Rising disposal fees and long hauling distances for grease disposal prompted Clearwater Tech to build this dewatering facility in an uninhabited area in Washington State. The remote location ensures there will be no odor complaints. (Photos by Dean Hare)



No Separation ANXIETY

Hands-on Clearwater Tech owners build their own custom dewatering solution offering simplicity and significant disposal cost savings

By Scottie Dayton



Scott Meyer, a partner in Clearwater Tech, moves large debris filtered from a load of wastewater in the first step in the company's dewatering process.

Rising disposal fees, diminishing disposal sites and hauling grease 100 miles to the treatment plant motivated John Ball of Roto-Rooter in Lewiston, Idaho, to turn his dream into action.

Ball had envisioned his own treatment plant since he and John Freand bought Roto-Rooter in 1997. When ex-farmer Scott Meyer

joined the partners, they agreed that the time was approaching to do something. The men started talking about dewatering the waste and land applying the biosolids. In 2002, they formed Clearwater Tech LLC and jumped into the unknown.

Despite two false starts, turning Ball's dream into reality wasn't difficult. Today, the plant, located in Port of Wilma, Wash., directly across the Snake River from Lewiston, processes all the waste produced by the Roto-Rooter business. The venture proved so successful that it became a model facility for Washington State's Department of Ecology.

AUCTION BARGAIN

An auction containing some dewatering equipment was the first lure. "The Auto-Vac filter from Alar Engineering Corp. was really cheap, which was why we bought it," says Freand. However, they decided to part with the filter and keep most of the other equipment that accompanied the dewatering system.

After investigating dewatering boxes, the partners bought a 15-cubic-yard unit from Consolidated Fabricators Corp. "The com-

pany had a silent auction at the 2003 Pumper & Cleaner Environmental Expo, and we got a great deal," says Freand. "The box is simple to operate. Septage gravity feeds through filters that catch all the solids, and effluent runs out the bottom."

Before building their facility, the men visited private dewatering sites. Levar Parker of Parker's Septic Tank Cleaning Service in Idaho Falls, Idaho, helped them the most. They learned more about screens and tank agitation from a facility in Grants Pass, Ore., which used an Auto-Vac filter. A plant in California provided more design ideas.

"The best wisdom we can pass on is to visit as many sites as possible before attempting to build your treatment plant," says Meyer. "That eliminated most of the trial-and-error factor for us."

Another recommendation is being on good terms with the agency responsible for environmental quality. "We were ready to build, but spent 18 months working out permitting and land application issues," Meyer continues. "This process took the longest, but the department of ecology staff was very helpful. They love our facility and give us great reviews."

Profile

Clearwater Tech LLC Lewiston, Idaho

Owners: John Ball, John Freand, Scott Meyer

Founded: 2002

Employees: 18

Specialties: Pumping

Service area: 100-mile radius

Associations: National Association of Wastewater Transporters, Northwest Biosolids Management Association





Clearwater Tech's John Freand scrapes solids from the filtering system. The company's dewatering facility is located in the Port of Wilma in Whitman County, Wash.

The partners built Clearwater Tech on 2.5 acres of leased land in Port of Wilma, an uninhabited area. "We didn't want any odor issues," says Freand.

Their Cover-All Building Systems steel frame and fabric structure is divided into a 40- by 62-foot room for the holding tanks and dewatering equipment, and a 60- by 62-foot storage area for the dry cakes. Heaters in the building keep the temperature just above freezing in winter. The partners recently built a 30- by 30-foot Cover-All over the 8,000-gallon concrete dump pit to protect it from wind and keep out rain.

RECIPE CALLS FOR ...

The plant went operational in May 2004.



At left, Freand adds concentrated polymer to the dewatering system at the Clearwater Tech processing plant. Above, he monitors the dewatering process.

"THE BEST WISDOM WE CAN PASS ON IS TO VISIT AS MANY SITES AS POSSIBLE BEFORE ATTEMPTING TO BUILD YOUR TREATMENT PLANT. THAT ELIMINATED MOST OF THE TRIAL-AND-ERROR FACTOR FOR US."

Scott Meyer

For their first 3,500-gallon batch, the partners tried injecting the polymer into the septage before it reached the dewatering box. "It was a disaster," says Meyer. "The solids stayed suspended in the liquid and wouldn't dewater."

They pumped out the box with a vacuum truck and started over, but not before Levar Parker arrived to help. He recommended using a batch tank, so they purchased a 500-gallon Poly-Mate tank from Flo Trend Systems Inc. It came with a variable-speed progressive cavity pump that injects the correct amount of polymer into the septage as it streams from the holding tank to the batch tank. "The batch tank gives the polymer time to age, enabling the septage to dewater better," says Freand.

The idea for a bar screen to filter garbage and hair came from the Grants Pass operator. The partners built a 3 1/2-foot-square enclosed steel box with vertical 1/4-inch carbon steel bars spaced 3/4 inch apart. The height of the bars increases 30 degrees from front to rear.

The bar screen, on a catwalk spanning the middle of the dump pit, rolls on rails. When Roto-Rooter vacuum trucks arrive, the box is rolled to the vehicle and a 6-inch hose attached to its discharge valve. Liquid runs through the screen and into the pit.



Clearwater Tech's partners are (from left) Scott Meyer, John Freand and John Ball. They're standing in front of one of the Roto-Rooter septic tank service trucks.

After discharging, a worker on the catwalk rolls the bar screen to a gutter, opens the door in the back of the box, rinses debris from the container, and rakes out whatever small solids remain. The bar screen produces a cubic yard of garbage a week, which is sprinkled with lime, bagged, and taken to the landfill.

A 7.5-hp Vaughan grinder pump pulls septage from the dump pit through a Muffin Monster grinder, which sends it to a 14,000- or 16,000-gallon steel holding tank. "If anything gets past our bar screen, these two grinders reduce it to 1/4-inch or smaller pieces," says Freand.

The receptacles, both recycled oil and diesel tanks, sit on blocks so they drain to the front. They are top loaded to eliminate accidental spills. A valve stack enables the partners to fill tanks individually. When one is full, the waste is processed.

TREATMENT TRAIN

The polymer is mixed with water, aged in the batch tank, and injected into the septage as a Grundfos 7.5-hp processing pump draws the slurry into the dewatering box at 165 gallons per minute. Simultaneously, a 10-hp Roots blower injects air through a perforated 2-inch pipe at the bottom of the tank. Aeration agitates the solids and grit, preventing them from accumulating.

A batch contains 80 percent septage and 20 percent grease. "We use a lot less polymer with that ratio and it dewateres better and cleaner," says Meyer. "If we start getting too much grease in our septage holding tanks, we store it in a 5,000-gallon grease tank for future use."

Filtrate water from the dewatering box flows through a floor sump, then submersible pumps send it to the facility's two 10,000-gallon steel storage tanks. A 1989 Kenworth 4,700-gallon tanker, and sometimes a 5,000-gallon Beall trailer tanker, haul the liquid to the Roto-Rooter shop. "We discharge it into a cleanout through a 1 1/2-inch hose so the stream enters the city flow slowly," says Freand. The Lewiston treatment plant charges a small fee to treat the wastewater.

GIVE ME LAND, LOTS OF LAND

After dewatering, the box is rolled into the storage room and the dry cakes of humus dumped out. When enough accumulate to fill the company dump truck, they are transported 22 miles to a field and stacked in windrows.

"The cakes form a crust after a few days,

"OUR PERMIT STATES THAT WE MUST INCORPORATE THE BIOSOLIDS WITHIN SIX HOURS OF APPLYING THEM. THE FARMER DOES THAT WITH A CULTIVATOR AND TINE HARROW, THEN SEEDS WHEAT OR BARLEY."

Scott Meyer

which seals in odors and keeps out moisture," says Freand. "Moisture really isn't a concern here, as this area's annual rainfall is only 12 to 14 inches."

The cakes are land applied only after fall harvest or before spring planting. As a front-end loader breaks up the windrows, they release a slight odor, but no one complains. The nearest house is two miles away, and the farmer owns thousands of acres for dispersing biosolids.

Traditional manure spreaders would not distribute loads evenly enough, so the partners researched and purchased a Model 8132 Pro Twin Slinger side delivery spreader from Kuhn Knight, and a used J.I. Case farm tractor to pull it. Two augers lying lengthwise in the spreader bed move the material into the hammer drum, which chops the cakes into dime-size pieces and disperses them in a 70-foot-wide path.

"Our permit states that we must incorporate the biosolids within six hours of applying them," says Meyer. "The farmer does that with a cultivator and tine harrow, then seeds wheat or barley."

One thing the partners learned is that offering free fertilizer is not enough. "You have to sweeten the pie," says Freand. "We pay the farmer for his time to incorporate the biosolids and rent the acre where we windrow the cakes. It's a good deal for both of us."

Clearwater Tech operates cheaply and efficiently, saves driver time, lowers fuel and maintenance costs, enhances customer service, and has solved Roto-Rooter's problem of how to dispose of its septage and grease trap waste. ■



Meyer takes on a pre-dawn pumping job cleaning the grease traps at a Lewiston, Idaho, McDonald's restaurant.

Roto-Rooter makes the septage rounds in Idaho

Roto-Rooter in Lewiston, Idaho, pumps most of the septic tanks and restaurant grease traps within its 100-mile service radius. It also cleans car wash pits and vault toilets for the U.S. Forest Service, U.S. Fish and Wildlife Service, and Idaho Department of Transportation.

Its drivers operate a 1989 Kenworth vacuum truck with 3,400-gallon tank, a 1996 Peterbilt with 3,600-gallon tank, and a 1987 International with 3,300-gallon tank. The 40,000 to 50,000 gallons of septage and grease trap waste they pump per week are dewatered at Clearwater Tech LLC, a facility built in 2002 by Roto-Rooter owners John Ball and John Freand, and Clearwater Tech partner Scott Meyer.

The men were paying 10 cents a gallon (\$150,000 to \$200,000 per year) to discharge at the Lewiston treatment plant. Building

Clearwater Tech cost \$400,000, but they did most of the work themselves. The partners run a batch every other day, processing 15,000 gallons in less than two hours. In 2007, the treatment plant raised its discharge fee to 15 cents a gallon and refused to accept grease trap waste from outside the county.



Scott Meyer, who serves as the lead pumping technician for Roto-Rooter, installs a plastic lid extension during a septic system inspection as trackhoe operator Dan Humphrey looks on.

A Roto-Rooter crew inspects a septic system for a customer who has had problems with the drainfield serving a 2-year-old home in Washington State.



MORE INFO:

Alar Engineering Corp.
708/479-6100
www.alarcorp.com

DRESSER Roots
877/363-7668
www.rootsblower.com

Flo Trend Inc.
713/699-0152
www.flotrend.com

WHY WAIT?

Our Ever Pro Tablets Dissolve Instantly.
Nothing is Safer, **Faster**, or Easier!



Simply drop one individually wrapped Portion Control **Ever Pro Tablet** into 5 gallons of fresh water. Instantly, the water soluble wrapping on our **Biodegradable** tablet begins to dissolve, releasing our powerful Non-Formaldehyde deodorizer.

● Flower Power ● Bubble Gum ● Fresh Scent ● Fresh & Clean ● Mulberry ● Citronella Plus™

Call our customer service team for more details.

1-800-345-3303
www.jjchem.com

J&J East - Athens, GA | J&J West - Moab, UT





Super Products

Worldwide Vacuum Technology - Since 1972

Supersucker® with High-Dump Option

- › Rear Lift Height up to 60"
- › Unloads Efficiently
- › Heavy Duty
- › Low Maintenance
- › Easy to Operate



www.superproductscorp.com

800.837.9711

ARMSTRONG EQUIPMENT INC.

MODEL 806B *SEELEVEL ANNIHILATOR*™

MODEL 806B *SEELEVEL ANNIHILATOR*™

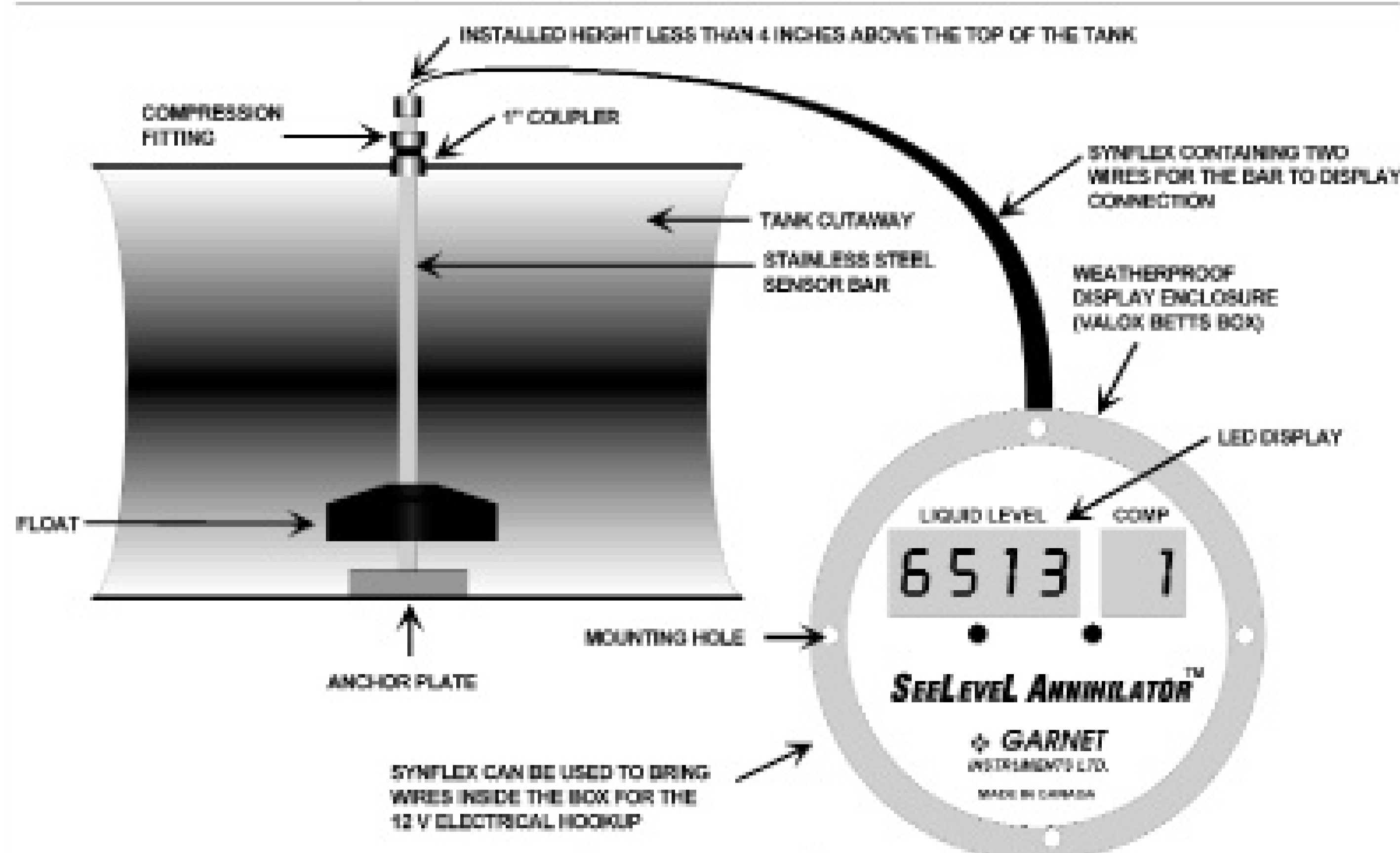

• **Accurate Readings to 1/4"**
Even with vacuum or pressure on the tank. No need to shut down pumping to check tank level.

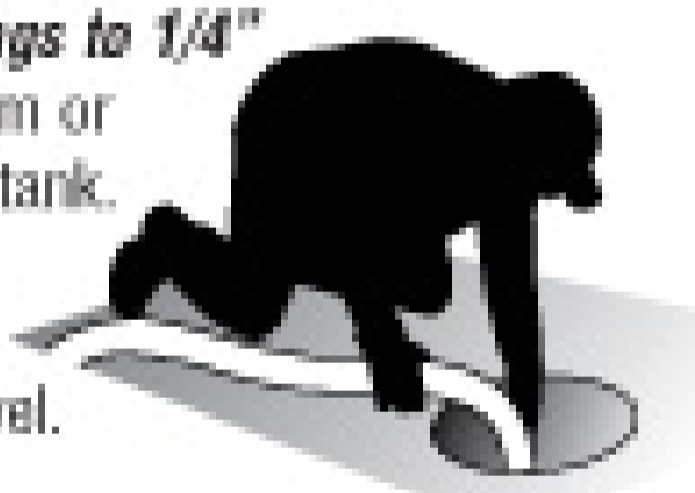

• **Protect Your Pump, Avoid Spills**
See the level of your tank throughout the pumping process.



• **Work Safely**
Can be programmed to control warning devices.



• **Maximize Efficiency**
Avoid unnecessary trips. Can I get one more load, or should I head for the dump? The guessing game is over.



• **Plan Your Route**
Tracking customers tank size allows for improved route planning.



• **Communicate With Your Customers**
Pumping 1500 gallons from a 1000 gallon tank indicates problems



These are all good reasons to equip your next truck with a SeeLevel model 806B liquid level gauge system. The 806B can be programmed to read liquid levels in up to three compartments with only one display. It can also accept up to three alarm settings for triggering a warning light, sounding an audible alarm, or closing a loading valve; all while the tank is loading.



11200 Greenstone Ave. | Santa Fe Springs, CA 90670
800.699.7557 or 562.944.0404 | fax: 562.944.3636
e-mail: sales@vacump.com | web: www.vacump.com

To find out if the 806B can benefit your business, contact your tank manufacturer or call us
Toll Free at 1-800-699-7557

27th TRUCKS INC.

WORLDWIDE EXPORTERS

8975 N.W. 27TH AVE. | MIAMI, FL 33147

PH: 305.835.9030 | EMAIL: INFO@27TH-TRUCKS.COM

Contact Alan @ 305-457-8058,
Armando @ 786-267-3026 or
David @ 786-236-9007



2000 PETERBILT

C12 Cat, New 4000 Gallon
Aluminum Tank, Fruitland Pump
RCF 500, 350 C.F.M., Custom Build.
Ready for Immediate Delivery!
Beautiful Truck!



COMING SOON

2005 Mack

3600 Carbon Steel Tank

2005 Mack

4000 Carbon Steel Tank

2005 Mack

4500 Carbon Steel Tank.



2000 PETERBILT C12

Cat 430 HP, 3600 Gallon
Progress Aluminum Tank
Fruitland Pump RCF 500,
350 C.F.M.



2001 MACK VISION CX613

4000 Gallon With Dumping
System, Jurop Pump LC420
46,000 LB Rear, With
Water Coolant.
READY FOR
IMMEDIATE DELIVERY!



2003 PETERBILT 379 SHORTHOOD

10 Spd., N14 Cummins, 470 HP, 5000
Gallons with 200 Fresh Water Compart-
ment, Jetter System, Tri Axle, Fruitland
Pump RCF 1200 650 C.F.M.
Best Truck of the Year.

2 Year
Factory Warranty
on Pumps

SOLD



THANK YOU

Mitchel, Mark &
Steve from United Septic.

5 year Factory Warranty
on Carbon Steel Tanks

**\$75,000 Financing
W.A.C.**

Low Monthly Payments \$1,495

**\$78,000 Financing
W.A.C.**

Low Monthly Payments \$1,555

SOLD



THANK YOU

Mr. John Woods from Pennsylvania

10 Year Factory Warranty
on Aluminum Tanks

WWW.27TH-TRUCKS.NET



NEW EQUIPMENT CUSTOM BUILT TO YOUR SPECIFICATIONS



(13335 A & B) **2009 Peterbilt 340** with a Presvac 3,200 gallon, c/s DOT certified 407/412 Dump type vacuum tanker with a full open rear **In Production!!**



(13336) **2009 Sterling LT9500** triaxle with a new Presvac, Powervac 3800, 3,250 gallon (US), DOT, wet/dry industrial, vacuum tank loader



(13317) **New PipeHunter Model 38T44 Jetting unit** Trailer mounted unit, w/ 335 Poly water tank 4,000 psi @ 25 gpm, 600 ft of hose and attachments.



(13297E) **2008 Peterbilt 340** with a Presvac 3,600 gallons (US), aluminum vacuum tank unit.



(5008V) **1990 Presvac 5,000** stainless steel D.O.T. with pump engine.



(13273B) **2007 New Acro Trailer** New Acro 7,000 gallon aluminum vacuum pressure tank.



(5392V) **2000 Freightliner FL80** (2 available) 4,000 U.S. gallons; Carbon Steel; 2-comp (3800/200) Vacuum-pressure tank and jetting system.



(13289) **New Presvac 2,000** U.S. gallon 2-compartment (1500/500), Aluminum vacuum tank, with a Moro M3 vacuum-pressure pump installed on a 2007 Chevy C7500 Cab and Chassis.



(2104V) **1999 Freightliner FL60** with a 1,000 U.S. gallon waste, 250 U.S. gallon water; 250 U.S. gallon mix; 3-compartment, Stainless Steel vacuum tank, with a NVE 184 vacuum pump and washdown system.



(8734V) **1998 International 4700** with a 1,500 U.S. gallon, 2-compartment (1100/400 split), Carbon Steel; portable toilet service unit.

Experience Matters.

Custom vacuum tanks built to your specifications.

For nearly 50 years, our tank builders have been setting the industry standard for innovation and value. Everything we build is customized to your exact specifications. Start with a bare tank and add only the options that are suitable for your application. What about service? Our technicians can rebuild pumps or furnish parts such as vanes, seal kits, housings, and rotors for most pumps. Whatever you need, let us put our experience to work for you.



Bare tank w/no attachments

Bare Tank:

Prices are for the tank only with no openings, hatches, rails or other attachments. LMT can furnish items for you to attach to your tank at additional cost. Please call for more information and pricing.



Basic tank w/optional manway and hoses

Basic Tank:

Prices include primary shutoff, full length rails (straight or tapered), 4" discharge nipple, and 3" intake nipple.

Check out some of the options:

- ✓ Manways (20", 25", 36")
- ✓ Full open door (2 types)
- ✓ Primary & secondary shutoffs
- ✓ Valves for loading & unloading
- ✓ Oil catch mufflers
- ✓ Suction hose & couplings
- ✓ Mounting rails & kits
- ✓ Vacuum pumps (Jurop, Masport, Moro, Fruitland, and others)
- ✓ Hosetrays and hangers

And more...

LMT Basic & Bare Tank Prices:

(subject to change without notice)

	Basic Tank	Bare Tank
1500 gallon: 54" dia. x 12' long w/1 baffle.....	\$ 5,150.....	\$ 3,765
2000 gallon: 60" dia. x 14' long w/2 baffles.....	6,200.....	4,850
2500 gallon: 66" dia. x 14' long w/2 baffles.....	7,100.....	5,700
3000 gallon: 68" dia. x 14' long w/2 baffles.....	8,000.....	6,570
3500 gallon: 72" dia. x 17' long w/2 baffles.....	9,550.....	8,030
4000 gallon: 78" dia. x 16' long w/2 baffles.....	10,685.....	9,125
4200 gallon: 78" dia. x 17' long w/2 baffles.....	11,170.....	9,590

Custom sizes up to 6000 gallon are available.

All lengths are can length excluding flanged and dished ends. All tanks over 70" dia. have 2 braces of 2" x 3" solid steel to prevent collapse of tank. All tanks are cleaned with an acid solution and prime painted. We can also customize the paint color for an extra fee. Tanks are manufactured with mild steel and are welded with submerged arc process for the best strength and appearance. Stainless steel is available at extra cost.



Call us at 800-545-0174 before you buy!

LMT Inc. - Custom Vacuum Tanks

Tel: 309.932.3311 • Fax: 309.932.3155 • info@tanksandpumps.com

www.tanksandpumps.com

Septic Tank Riser, Lid & Safety Pan™

FREE FREIGHT ON FULL CARTONS!

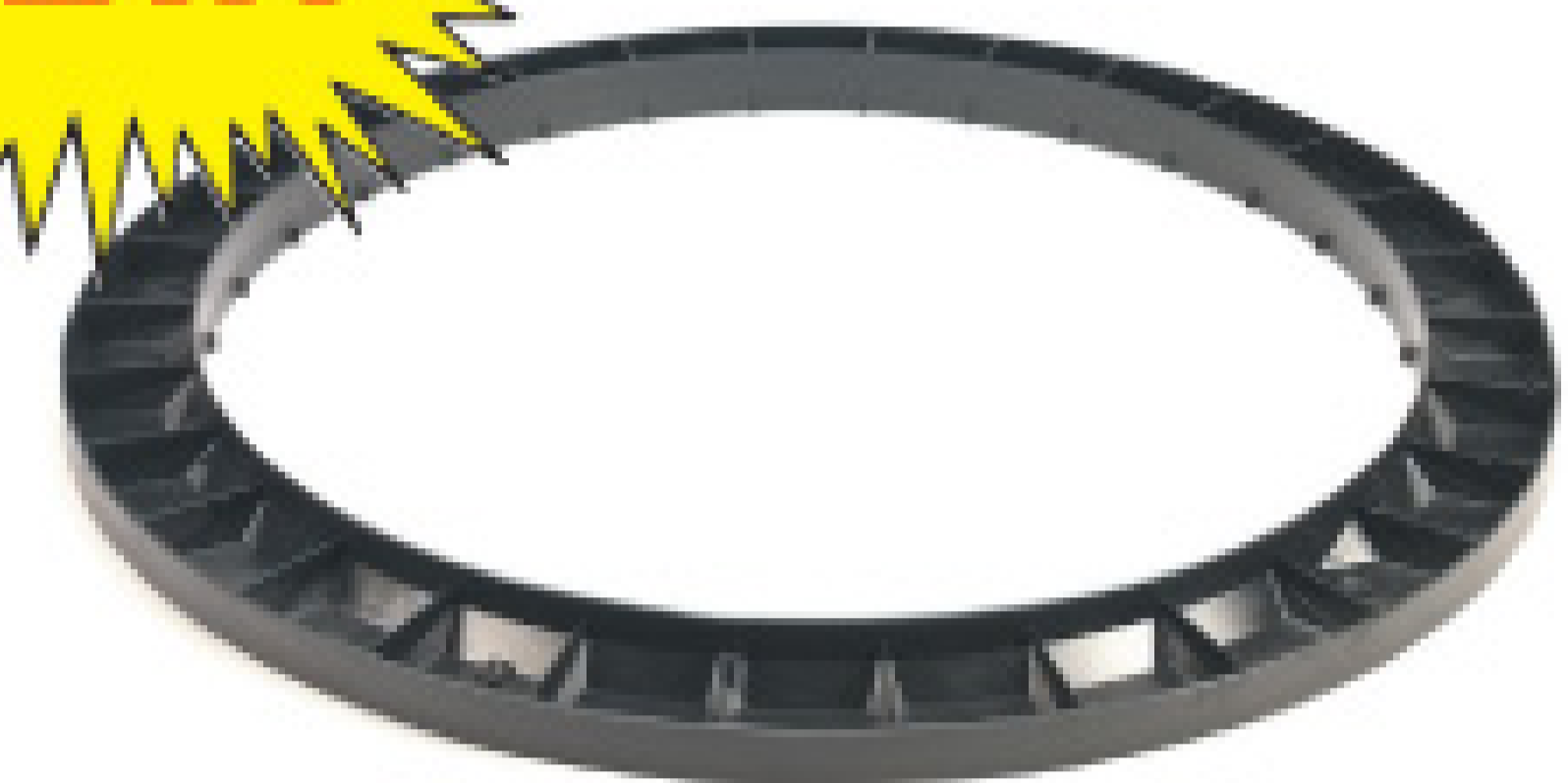
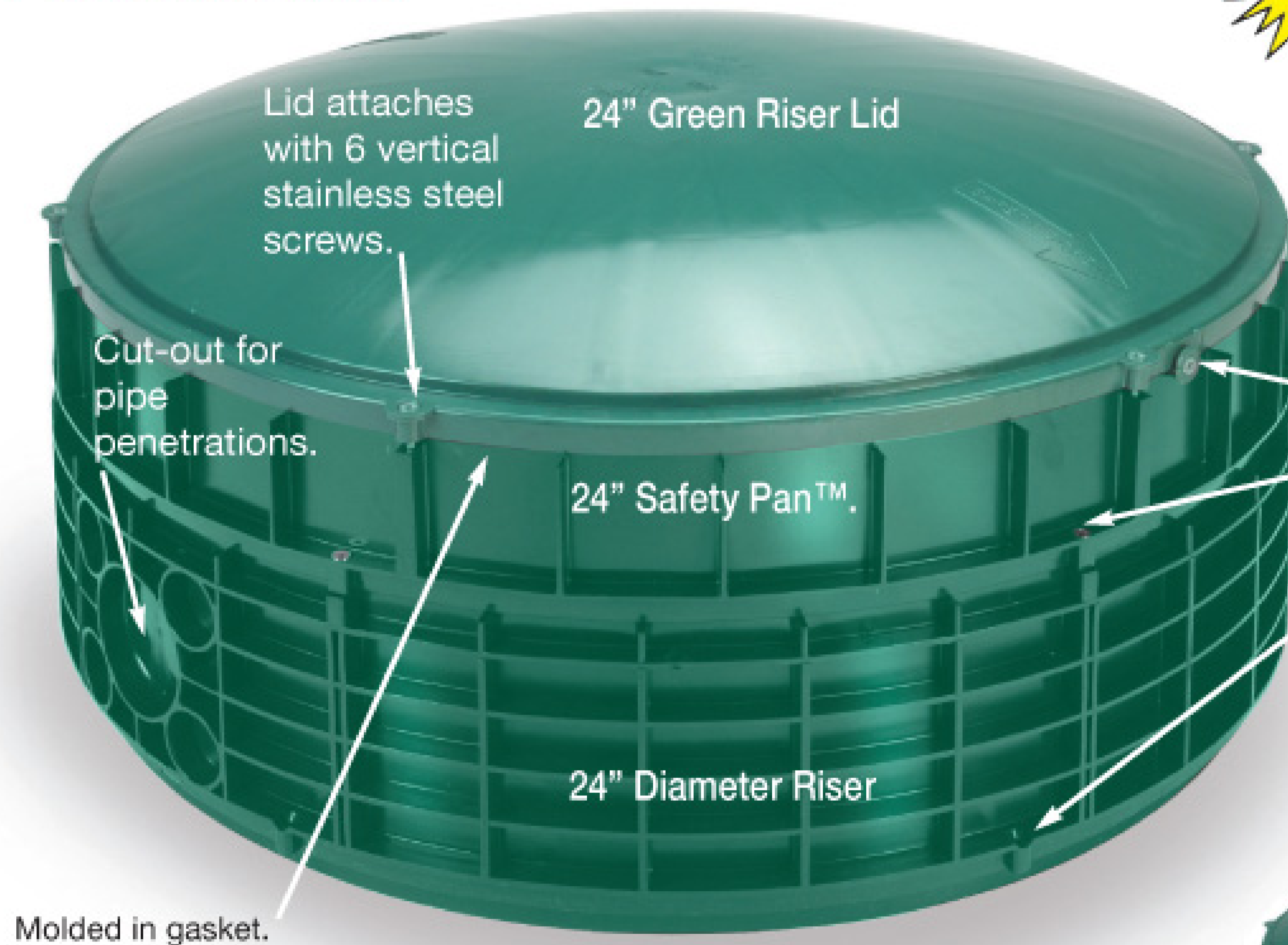

Tank Adapter Ring

New - Horizontal Safety Screw.

Safety Pan™ to Riser attachment with 6 vertical stainless steel screws.

Riser to Riser attachment with 6 vertical stainless steel screws.

Patent Numbers
5,617,679 &
5,852,901; other
pats. pending.

Riser Lid

with Molded-in gasket.
Available in 12", 16", 20" and 24" diameters.



Concrete Lid w/handle

Safety Pan™

Safety Pan™ available in 16", 20" and 24" diameters.



12", 17", or 20"

Riser

For septic tanks. Stackable in 6" increments. Available in 12", 16", 20" and 24" diameters.

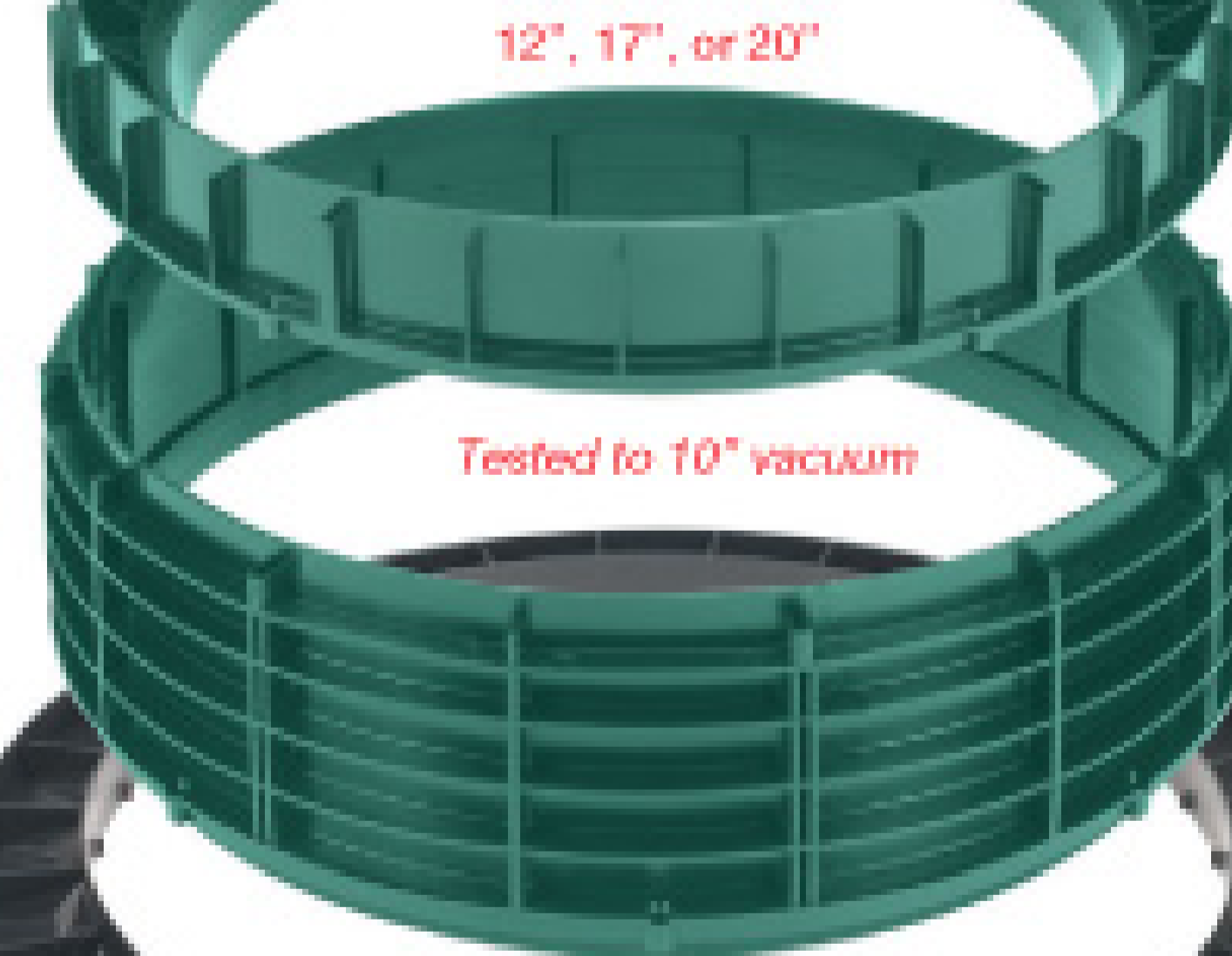

Tested to 10" vacuum

Tank Adapter Ring

For mounting riser flush to top of tank when casting-in is not an option.



Effluent Filters

Patent Numbers
6,319,403; D 431,629; other
pats. pending.

800 GPD
ANSI/NSF
Standard 46

4" Sch. 40 &
SDR-35

EF-4
4" Filter

1500 GPD
ANSI/NSF
Standard 46

4" Sch. 40 &
SDR-35

244 ft. of
1/16" filtration
area.

EF-6
6" Filter

Gas/Solids
Deflector



One-Piece Tank Seal

For concrete Septic tanks and D-boxes.
Accepts pipes from 1-1/2" to 4".
Mounts with or without concrete flash.



TS-4-RUBBER TANK SEAL
(will hold 10psi)
TS-4PRO TANK SEAL
(will hold 5" vacuum)



Free Freight: 32¢

Patent No's
4,951,914,
5,624,123
& 5,711,536;

TIGERFLEX™



Tiger™ Green/Tiger™ Yellow/Tiger™ - SD

- Superior EPDM compounds - longer life; more durable; superior chemical resistance.
- Superior Flexibility - 22% more flexible! Easier to handle off trucks, especially in cold weather!
- UV and weather resistant exterior.
- Specially designed abrasion-resistant helix – slides over and around objects; easier to handle and work with.
- Tiger™-SD – reinforced for both suction & pressure discharge applications.

Applications:

- Septic handling
- Liquid and dry chemical & fertilizers
- Sewer cleaning water jetting leader hose
- Construction



Kuriyama of America, Inc.

360 E State Parkway | Schaumburg, IL 60173 | fax: 847.885.0996
847.755.0360 | email: sales@kuriyama.com | www.kuriyama.com

The ROTARY PRESS

patented

Dewaters Grease & Septic Waste

High capture rate
High cake solids

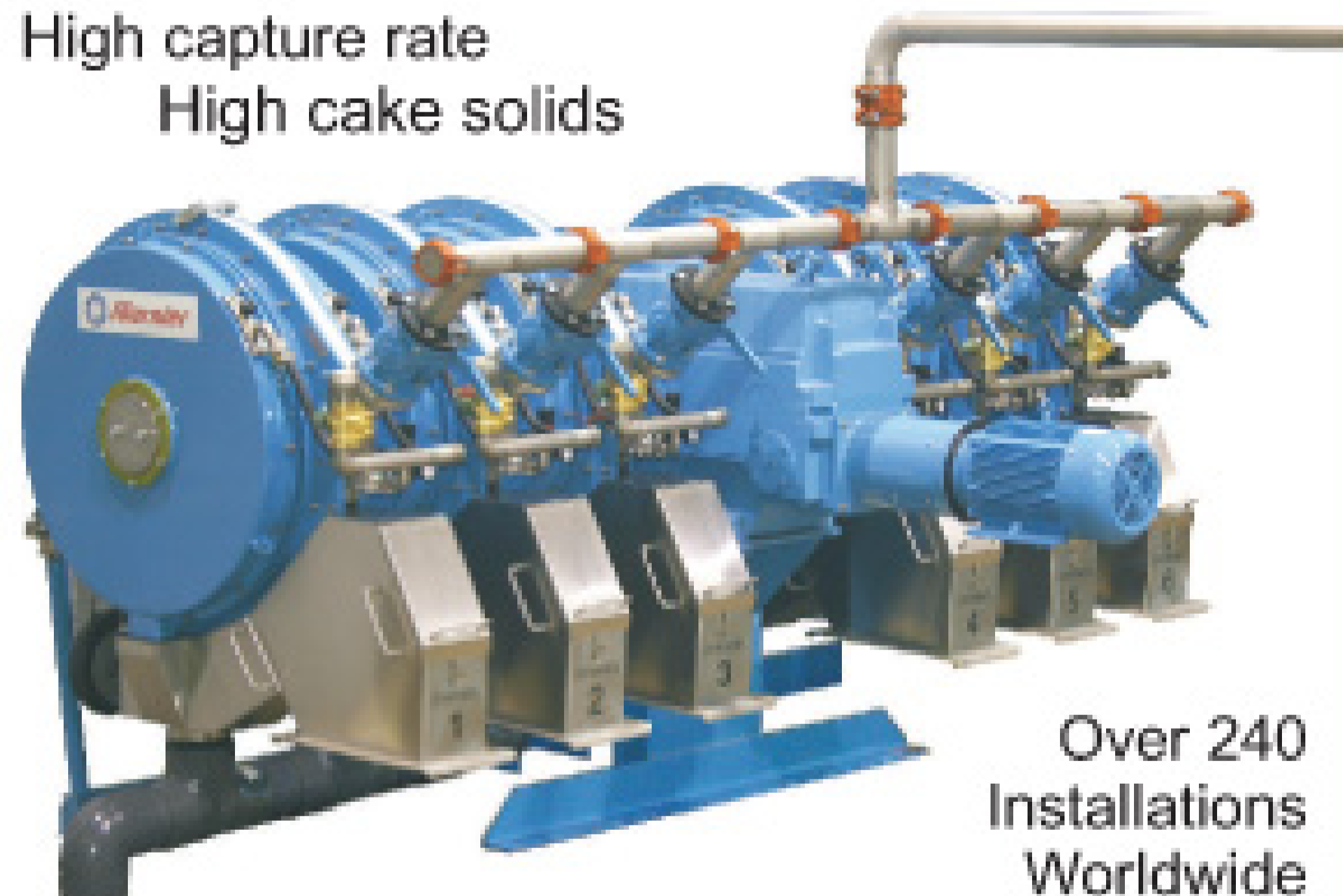

Over 240
Installations
Worldwide

US patent No. 7,166,229

Low wash water use
Low Speed, Low Power,
Low Maintenance,
Fully-Automated,
Operator-Friendly



Since 1960

3787 Frontenac W., Thetford Mines, Qc., Canada

Granby sales office - Tel: (450) 375-7060 Fax: (450) 777-6066

www.rotary-press.com

Represented across the U.S. and around the world

Comforts of Home

Services, Inc.

LUXURY TRAILER SALES

- Lowest Interior Floor Height in the Industry
- ADA wheelchair accessible units.
- Unlimited Floor Plans from 8' to 53' Trailers
- Rigid Steel Shell Construction from top to bottom to resist rot and warping.
- Specializing in Customizing trailers to fit your needs.
- 24/7 Tech Support for the best customer service available.
- Free Nation Wide Lead Program for our customers.
- Easy Fold-Up Steps & Door Handles
- Large Capacity Waste Tanks
- High Privacy Partitions are Standard for Added Comfort
- Rigid Platform, our smallest wide body trailers start out with Dual 10" ASTM I-Beams.

Starting at \$13,400 with A/C, Heat, HD Steps and a Large 300 Gallon Waste Tank

See our website for more layouts and prices



8' starting at \$13,400
w/A/C & Heat - 300 gal waste

12' starting at \$21,300
w/A/C & Heat - 450 gal waste
includes Showers

20' starting at \$29,500
w/A/C & Heat - 600 gal waste

24' ADA starting at \$35,600
w/A/C & Heat - 750 gal waste

INFO@COHSI.COM • 877.382.2935 • WWW.COHSI.COM

TRANSPORT TRUCK SALES, INC.

Ask for Scott or Frank – 888-395-7551
After hours call Scott at 816-590-4076

TTS

What Does It Take To Be A "Qualified Chassis"?

- ✓ Pass our 12 point checklist. (We send this out with every quote!)
- ✓ Pass a D.O.T. certified inspection!
- ✓ Pass the warranty inspection!

What Does All This Do For You?

- ✓ Nationwide drive train warranty for 2 years/ 200K miles! (restrictions apply)
- ✓ A tough truck that is ready to work as hard as you do!

YOUR TRADES ARE WELCOME!

Searching For A Brand New Chassis?
We Have Them In Stock!



(2) 2004 Freightliner M-2, Cat 210HP, 6spd, 33# GVW, air brakes, AC, new 2300 gallon steel vac tank, new Jurop PN-84 vac pump.

Call For Pricing!

2-YEAR 100,000 MILE DRIVE TRAIN WARRANTY



2001 Mack CH613, E-7 400HP, 10spd, AC, double framed, new 3360 gallon steel vac tank, new liquid cooled Masport HXL-400 Vac pump.

Call For Pricing!

2-YEAR 200,000 MILE DRIVE TRAIN WARRANTY



2000 Mack CH613, E-7 400HP, 10spd, AC, double framed, new 3360 gallon steel vac tank, new Liquid cooled Masport HXL-400 Vac pump.

Call For Pricing!

2-YEAR 200,000 MILE DRIVE TRAIN WARRANTY



2001 Mack CL-713, E-7 460HP, 18spd, jakes, 20# fronts, 46# rears, double framed, new 3360 gal. steel tank, new liquid cooled HXL-400 Masport vac pump.

Call For Pricing!

2-YEAR 200,000 MILE DRIVE TRAIN WARRANTY



2001 Freightliner FLD120SD, Cummins 330HP, 9spd, 14,600 fronts, double framed, new 3600 gallon Alum. vac tank, new Liquid cooled 400 HXL Masport Vac pump, 10-Year no leak warranty on tank.

Call For Pricing!

2-YEAR 200,000 MILE DRIVE TRAIN WARRANTY



2002 Freightliner FL-112, Cat 350HP, 9spd, jakes, 14,600 fronts, double framed, new 3360 gallon steel vac tank, new liquid cooled Masport HXL-400 Vac pump.

Call For Pricing!

2-YEAR 200,000 MILE DRIVE TRAIN WARRANTY

Delivery Available Anywhere in the Lower 48!!

The University of Phoenix Stadium was the site of Super Bowl XLII in February. The location was what likely tipped off the National Football League that a pumper was using the Super Bowl Waste Services name. Inset, Steve Fanning poses with a tank painted with his company's new name. (Photos courtesy of Robert Carlson)



Losing the SUPER BOWL

Claiming trademark infringement, the NFL forced a Phoenix portable sanitation company to change its name on the eve of the big game

By Robert E. Carlson

The National Football League is a multi-billion-dollar business that captures the attention of hundreds of millions of fans on Sunday afternoons, and practically every other day of the week during its season.

This kingpin of American sports still found time, however, to engage in a legal battle with Phoenix, Ariz., pumper Steve Fanning over what appears now to be an unfortunate name choice for his small portable sanitation business.

Fanning has a long and successful history in the industry. He began working for someone else and then started his own pumping business, Johnny On The Spot.

When service giant Waste Management Inc. sought to expand in the Phoenix area, it bought

Johnny On the Spot from Fanning and hired him to run the local branch. When the non-compete clause in Fanning's contract with Waste Management expired, he decided to start another business and it needed a name.

What should he call the new business? While working in Denver in the mid-1980s, his competitor was named Super Bowl Waste Services. Fanning was well aware of the football game, but he liked how the name applied to portable sanitation. Certainly, there was a

double meaning, just as other pumpers have capitalized on double meanings, taking names such as Royal Flush.

Fanning was familiar with the owner of the Denver company, so he called and asked if there were any issues over using the name. The owner replied, "Never been a problem." This is where Fanning may have made a major mistake. Rather than call a portable sanitation company in Colorado, he probably should have called the offices of the NFL in New York.

"The NFL is a business. They claimed we were diluting the name Super Bowl. That's what it was all about for them. They said we were using their name for our personal gain. And I thought we were just pumping and cleaning toilets."

Steve Fanning



This is what Fanning's trucks looked like when the NFL demanded he change the company name.

PERIOD OF EXPANSION

So Fanning had a vacuum service truck built. Using white, orange and green, he came up with an attractive truck with the signage: Super Bowl Waste Services. The reference to the task of cleaning toilets was obvious. As time passed, he added more trucks to his fleet. The booming construction market and the growth in the Phoenix area kept Fanning on his toes. By the end of 2007, he had 17 vehicles in his fleet and 13 of those were portable restroom service trucks.

So how did a local pumper in Phoenix capture the attention of the NFL? Fanning's home base was selected as the site of the 2008 Super Bowl.

In April 2007, Fanning received a letter from NFL Properties ordering him to "cease and desist" all operations under the Super Bowl Waste Services name. The letter said he must abandon the business name. He had 10 days to respond.

Fanning was dubious of the letter, but hired a well-known law firm in Denver that specialized in copyright and trademark infringement. The law firm responded to the NFL, arguing there was no reason Fanning should have to change the name. There were no copyrights or trademarks being infringed upon, so Fanning would not stop doing business under the Super Bowl name.

The NFL sent more letters, Fanning said, insisting that the name on his trucks and restrooms had to change. By June 2007, after a flurry of letters back and forth, things quieted down. Fanning figured his legal troubles were over.

About Thanksgiving, another set of letters came. Again the NFL demanded Fanning change all signage using Super Bowl. The league wanted a final answer in a few days, and one in which Fanning would agree to surrender his name.

Backed by the law firm Dorsey-Whitney, Fanning felt he had a chance to keep the business name. The NFL learned from the law firm's response that Fanning wasn't about to give up the fight.

A meeting with the legal teams for the NFL and Fanning was arranged for January, a few weeks before the Super Bowl. Fanning's lawyers believed the name Super Bowl was exempted from legal ownership because of a common "famous names" status.

NOT RELATED TO FOOTBALL

His attorneys explained the difference to Fanning like this: You can buy all the apples you want and you can use the name "apple" any way you want until you associate it with

computers. Then you have problems. Then you're "living off" the "famous name." From that standpoint, Fanning's lawyers believed

that Super Bowl Waste Services didn't interfere with or profit by the football game's notoriety. There were no goalposts or footballs included in Fanning's truck or restroom signage. No symbols or references to the big game were used in Fanning's advertising, invoices or contracts.

According to Fanning, the NFL introduced a study proving that the general public often associated the pumping company with the NFL's marquee game. The football league conducted a survey in which people were shown photos of Fanning's restrooms and asked what they thought about when they saw the images. Roughly 30 percent said they thought of the football game. Fanning's attorneys told him it only takes 16 percent recognition to support the NFL's contention that his business profited from its association with the Super Bowl.

The NFL wasn't going to take no for an answer.

Fanning said his lawyers estimated he had a good chance of winning if he fought in court to maintain the name. But if the NFL wanted to keep the case going, it could cost Fanning \$300,000 to \$500,000 to maintain his company name. The bill had already reached \$25,000.

Time to settle.

The NFL presented Fanning with a 25-page written settlement agreement. Part of the settlement reads: "Super Bowl Waste Services shall not operate any aspect of its business under the name Super Bowl including displaying any portable toilets, signage or trucks with the phrase Super Bowl or the words Super or Bowl within 10 miles of the Super Bowl XLII Championship Game." They also added that Super Bowl Waste not be any closer than five miles from a Super Bowl-related event for 14 days prior to the Super Bowl.

NO TIME TO CHANGE LABELS

Fanning responded that he already had restrooms on jobsites close to the stadium and he had commitments to service them. The NFL told him to get new stickers with a different name. Fanning argued it was impossible in the time frame they were requesting.

So they negotiated how long they would let Fanning take to complete the name change. First, they told Fanning to have the name change done before kickoff. Fanning told them

"Registered trademarks that are considered 'famous' are afforded the greatest level of protection. The Super Bowl is registered and famous."

Brian McCarthy

he wanted two years. The NFL offered to allow five months. That didn't fly either. They ended up compromising and giving Fanning one year to change signage, and allowed 10 percent of his units to remain unchanged.

Also, according to Fanning, the NFL refused his request to cover his legal fees and costs associated with changing his company name.

Fanning reported the changeover will cost him more than \$100,000. Super Bowl Waste Services will soon be history. Fanning has changed out his first truck. One by one, the old signage is being removed from the trucks and the restrooms and a new name, Elite Waste Services, is being added.

NOT A BIG FAN

Fanning had always enjoyed NFL games, but the legal battle has dampened his enthusiasm.

"The NFL is a business. They claimed we were diluting the name Super Bowl. That's what it was all about for them," Fanning said. "They said we were using their name for our personal gain. And I thought we were just pumping and cleaning toilets."

A spokesman for the NFL, Brian McCarthy, said the league is justified in its pursuit of companies it believes are capitalizing on the Super Bowl name.

"We have many federal and state trademark registrations for the Super Bowl trademark. These registrations have been on file for decades. Registered trademarks that are considered 'famous' are afforded the greatest level of protection. The Super Bowl is registered and famous."

McCarthy explained it's standard procedure for the NFL to send "cease and desist" letters to any business using the Super Bowl name. Businesses that don't abide by the orders are contacted by legal counsel of the NFL. McCarthy said he could produce 50 letters similar to the one Fanning received.

McCarthy said the NFL will continue to search out other businesses that use the league's famous name. It plans to eliminate any and all references from the championship game by outside sources, even though the meaning of the words Super Bowl may have nothing to do with a football game. ■

Your Turn Key Solution To Trucks "Ready to Go"

2008 Kenworth T300 - 22,000 GVW

Cummins diesel, Allison automatic,
Hydraulic brakes,
AC, AM/FM,
Turbo exhaust brake.

1700 Gallon **POTEA VAC**

400 fresh / 1300 waste
Masport HXL 4,
Burks wash down,
Hot shift PTO
Unit hauler and tow package.



\$76,900 Monthly from **\$916.**

**Refurbished Chassis...
NEW! Tank & Equipment...SAVE!**

2001 Freightliner FLD112

ISM 330 H.P. Cummins - 9 speed
200,000 Mile Power Train Warranty
New! 3600 Gallon Septic Tank
Masport HXL400 pump
Large Tool Box.



\$82,000 from \$1,619 mo.

Contact:

Glenn "Mac" McCallister
gmmccallister@semotank.com

Donnie Moyers
tdmoyers@semotank.com

Jeff Kalp
jnkalp@semotank.com

2000 Gallon Restroom Tank

Standard pumping system*
Dual service - (2) reels

2008 Sterling - Acterra

26,000 G.V.W., auto trans., air brakes

\$81,177

Lease from **\$1623** mo.

2008 Sterling Bullet Restroom Service

Cummins diesel-305 HP,
6 speed manual,
7000 lb front /13,500 lb. Rear
Exhaust Brake, AM/FM-CD...

1250 Gallon Tank (2) Compt.

Masport HXL4, dual service,
Burks DC 10 wash down system,
Tow package and toilet carrier.

\$66,950

F.O.B. Kansas City

As Low As... **\$1339** mo.



800-264-8348 Voice

573-547-8420 Fax

573-450-5196 After Hours

www.semotank.com

SEMO/BAKER ACRO

United to Broaden Your Tank Services

456 Semo Lane, Perryville, MO 63775

PUT THE
SQUEEZE
ON WET WASTE ...
With Belt Filter Press Dewatering



Rentals

Skid Systems

Mobile Units



Made in the USA

Touch Screen Controls

Highest Dewatering Throughputs available

Stainless Steel Construction on Frame, Rollers and pans

Grease Trap Waste

Septage Waste

Industrial Waste

Toll Free: 800-253-0532

Phone: 269-793-7183 Fax: 269-793-8793

127 N. Water St., Hopkins, MI 49328

Contact: Julie VanderMoore at

julie@brightbeltpress.com

269-793-3423

www.brightbeltpress.com

\$ We've Got the Money \$

For All Your New and Used Equipment Needs

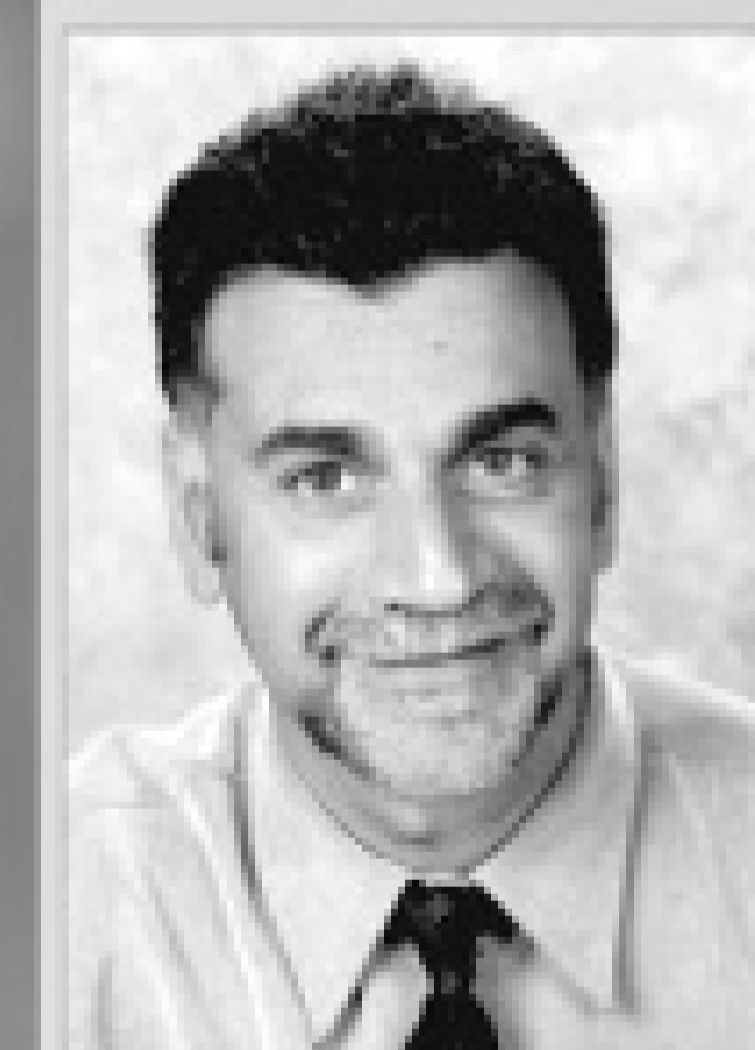

Chuck Territo

- \$250k Application Only
- Simple Approval Process
- Lease or Loan Options
- New & Used Equipment
- Flexible Finance Options
- Start Up Programs



Mike Rausch

Let us put our 35 years of experience to
work for you! Call today and see why...

It pays to lease with us!

Granite Leasing Co.

800.246.7997

www.graniteleasing.com

Beautiful inside and out.



Taj



With standard features like an oversized mirror, recirculating flush system, the new StyleLite sink, and twice the floor space of traditional special event restrooms, it's no wonder the Taj is the bride's favorite guest. Visit the complete line-up of Hampel special event restrooms including the Taj, Grandeur, Family Affair, and Oro Rojo at HampelCorp.com.



Oro Rojo

Family Affair

Grandeur

Engineered for strength, durability and value.

www.hampelcorp.com • 800-549-1558

WE'VE GOT DRESSER ROOTS BLOWERS ... AND A LOT MORE

The Dresser Roots blowers are the finest truck mounted units available today. And, as a factory authorized sales and service center we're here to provide the best support for all your blower applications.

We're also here to help with your vacuum equipment repairs, rebuilding, and replacements that also includes our special blower exchange program.

Just give us a call.

 **Roots**

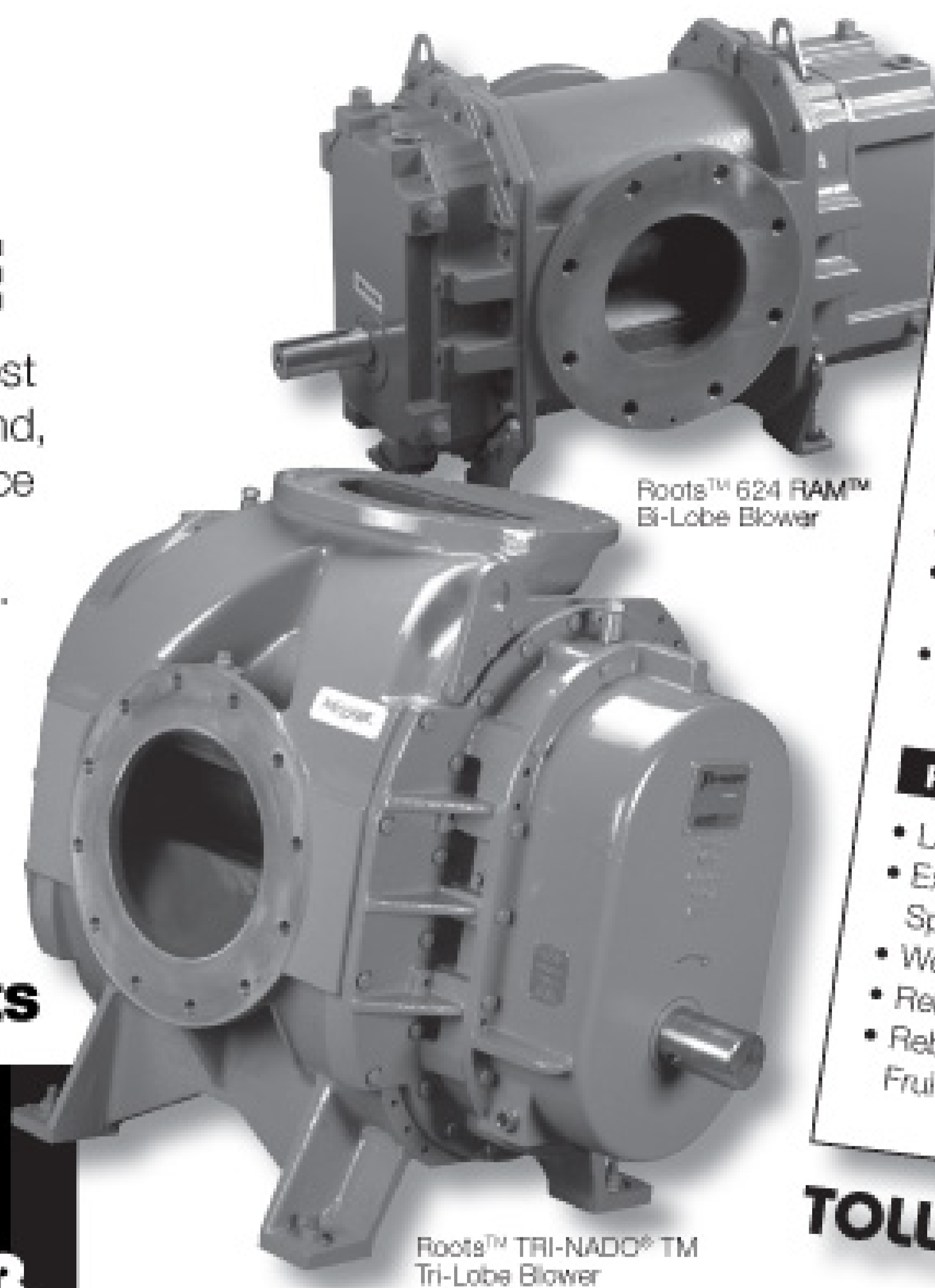

Roots™ 624 RAM™
Bi-Lobe Blower

Roots™ TRI-NADO™ TM
Tri-Lobe Blower

VACUUM PUMPS, TRUCKS & ACCESSORIES

- Aquatech** • Sewer trucks & equipment
- Conde** • Toilet truck vacuum pumps
- Hi Vac** • Industrial vacuum systems
- Metaltecnica** • Valves & accessories
- O'Brien** • Sewer cleaning jettors
- Presvac** • Septic & sewer trucks
- Roots** • Bi-lobe & tri-lobe vacuum blowers
- Stoddard** • Intake filters & discharge silencers
- World-Tech** • Sewer cleaning nozzles & valves

COMPLETE FABRICATION & MACHINE SHOP

- 24 Hour service
- Custom built blower and pump vacuum/pressure packages: electric, gas, or diesel
- Custom parts fabricated or reconditioned including bearings, shafts & sleeves

REBUILD SPECIALISTS

- Largest blower repair center in the Universe.
- Experts in rebuilding blowers: Roots, Sutorbilt, Spencer, and Hibon
- We rebuild all vacuum pump makes and models
- Rehab sewer cleaning trucks and equipment
- Rebuild kits in stock for Schult, Wittig, Moro, Jurup, Fruitland, and Challenger

TOLL FREE: (800) 359-PUMP

Orlando, FL: 800-359-7867 • WWW.PATSPUMP.COM • Atlanta, GA: 800-851-7987



Tanks For Your Business

Mid-State Tank manufactures stainless steel and aluminum tanks and has become a well-known and respected supplier for the agricultural, aviation, industrial and fire services, as well as pressure/vacuum tanks.

Mid-State Tank holds an ASME stamp and is D.O.T. approved.



Mid-State Tank Co., Inc.

PO Box 317 • Sullivan, IL 61951
(800) 722-8384 • Fax: (217) 728-8384
www.midstatetank.com



Wolf Creek Co.

Original Bauer

Portable Piping

Bauer Fittings

Polybarb™ Pipe & Tails

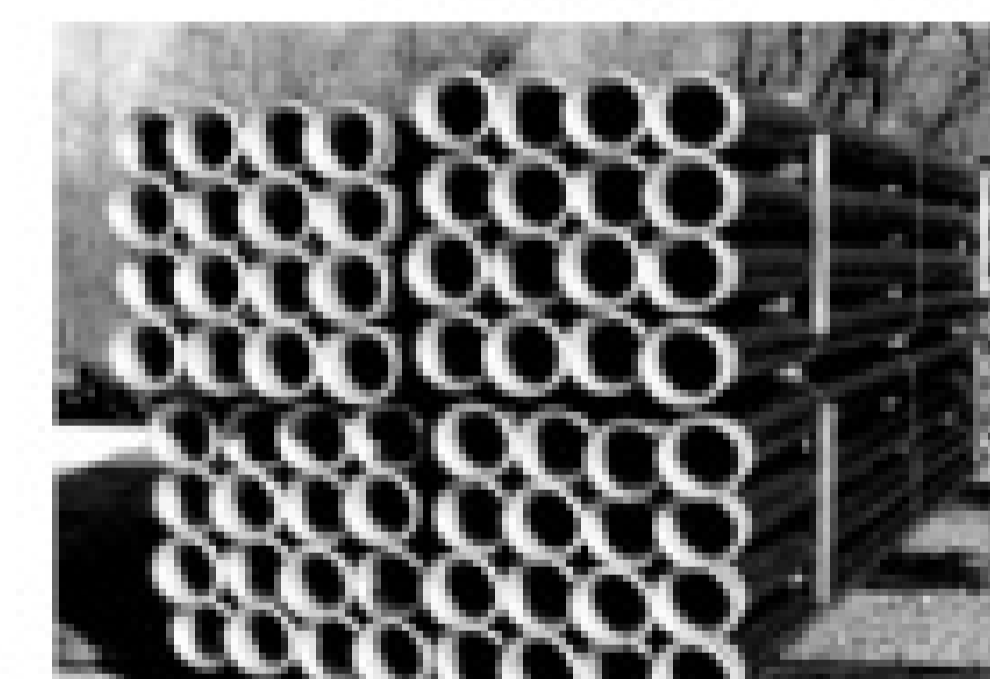

Polybarb™ HDPE pipes and fusible tails available in 4" to 12" diameters up to 40' in length.

Available in weldable, hose insert, and flanged connections.
Fittings available from 2" to 12".

Industrial Vac Tubes

We can fabricate aluminum vacuum evacuation or suction tubes per your specifications. Using the Bauer Coupler or Anfor Coupler.

Bauer Pipe



Galvanized piping available in 2" to 12"

800.488.7305 • www.wolfcreekcompany.com



"Built to do the work for you."



◆ (1) - 2008 Peterbilt 340 with a PX 8 330 HP and a 10 spd. Eaton-Fuller transmission, 76" dia., 3,150 gal., $\frac{5}{16}$ " Shell, Full Tilt/Open, with 4" intake, 6" discharge, RCF Fruitland 500 pump

◆ (2) - 2000 International 9100, N14 Cummins (370/435 hp), 470K miles, 10 spd. Trans., 76" dia., 3,000 gal., $\frac{1}{4}$ " Shell, Full Tilt/Open, 4" intake, 6" discharge, RCF Fruitland 500 pump



◆ ***In Stock*** ◆

ASME DOT 407/412 CODE UNITS

Mounted on a new or used Peterbilt, International or Freightliner

◆ 6 in stock - 76" dia., 3,000 gal., $\frac{1}{4}$ " Shell, Full Tilt/ Open, ready to be mounted*

Call for quotes * Tanks can be shipped.



MANUFACTURER OF DOT 407/412 TANKS

*For more information
contact L.C. Sutton*



Global Vacuum Systems, Inc.

32804 US 290 West

Hockley, TX 77447

Toll Free: 800-843-0866

Email: info@globalvacuumsystems.com

Web: www.globalvacuumsystems.com



Lely Waste Solutions, LLC

Temple, TX | 800 367 5359



THANKS TO
BRIDGES PORT-A-POTTY



THANKS TO
OSCAR'S SEPTIC SERVICE

WE STOCK PACKING FOR
RIV VALVES



Temple, TX
800 367 5359
Fax 254 938 7204

Bruce Curry
bcurry@lelywaste.com
Earl Ballard
eballard@lelywaste.com

MOBILE RESTROOM TRAILERS

From The Experienced Professionals at
WELLS CARGO COG

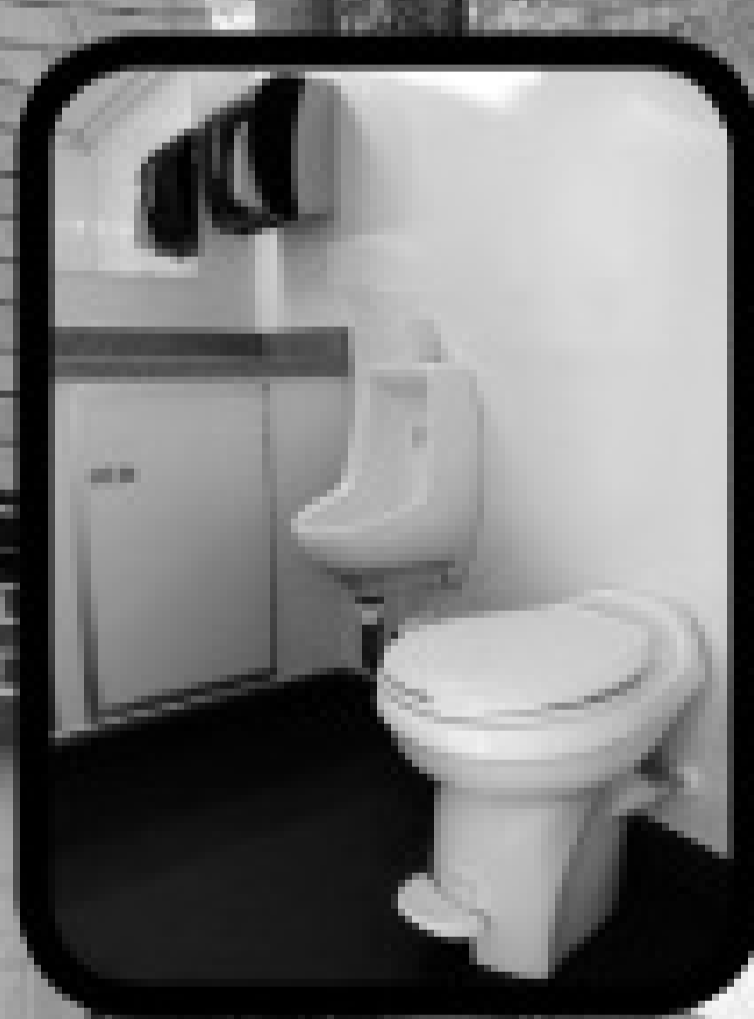

The **Comfort Elite Series** is the perfect solution for "on-site" portable restrooms and showers. Totally self-contained and environmentally friendly, the **Comfort Elite Series** is a welcome addition to any special event where demanding expectations are the norm. With the industry's shortest production lead times* and unmatched experience, the professionals at **Wells Cargo COG** will work closely with you to find the perfect solution to your mobile sanitation needs.



ADA Units



Showers



Lead Referrals



Call: 888.574.4222

Click: www.wellscargocog.com

**Standard units usually in stock & ready-to-ship!*



Never Look Back Warranty Program

Irrigation fittings are for irrigating – NOT vacuum.
 How many dollars are you spending **SUCKING AIR?**
 Industry-proven, quality vacuum couplings from Bandlock
 will put money into your pockets.

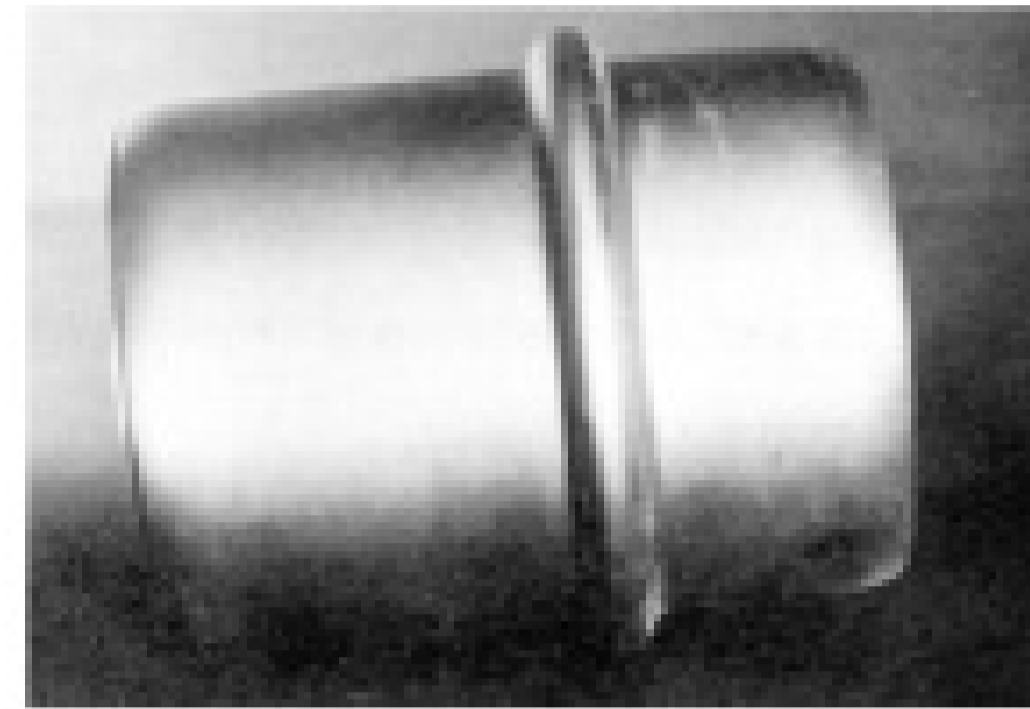

BANDLOCK BL
 4" to 12" MR Male Coupler



BANDLOCK BL
 4" to 12" FR Female Coupler



Aluminum Coupler RLM
 6" and 8" Aluminum
 Male Weldon



Steel
 Crown
 4", 6"
 and 8"
 Press
 End

**CLOSE TOLERANCE
 COUPLERS AND
 FITTINGS BRING
 "SAFETY" TO YOUR
 WORK PLACE.**

**Recognized
 as the
 #1
 Relief Valve
 in the
 World**



Aluminum Pipe with Steel Press Ends,
 Steel Pipe Weldons, Aluminum Weldons

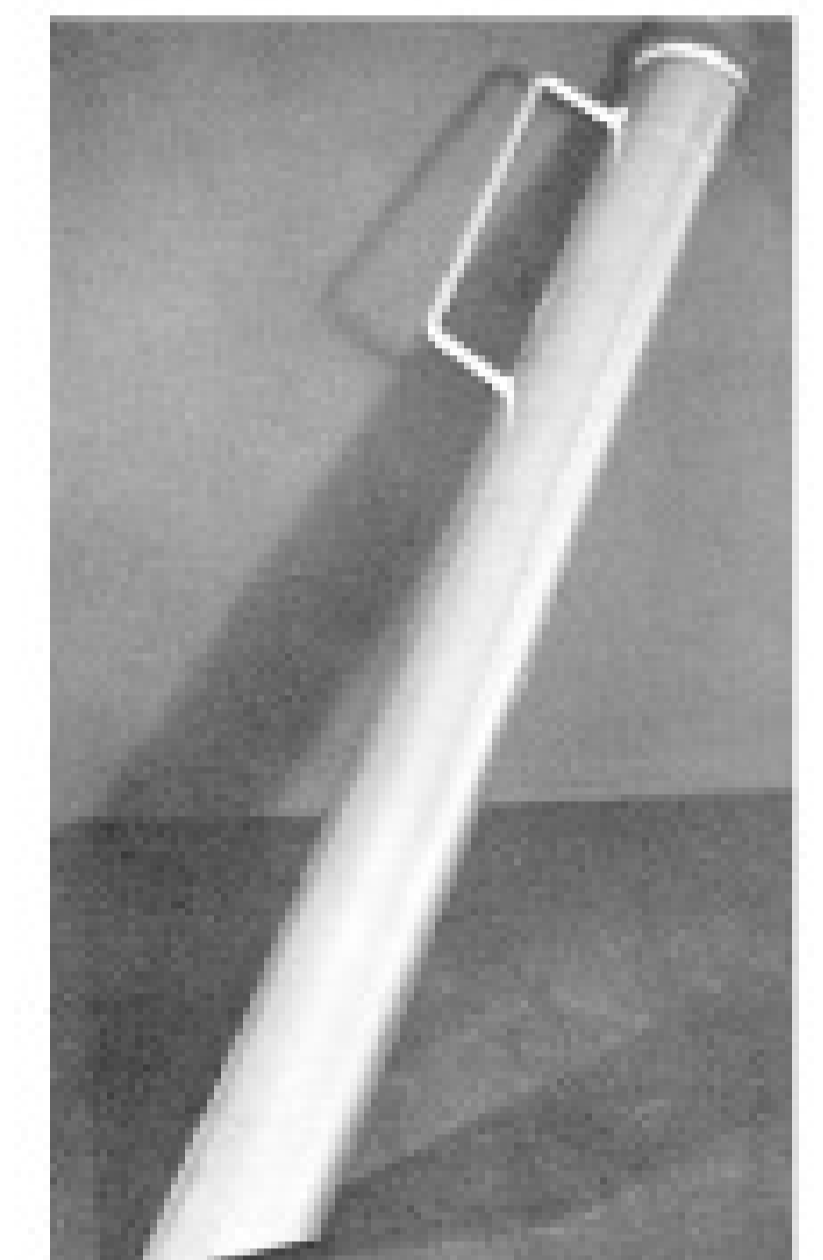

4" and 6" High
 Abrasive Bulk Nozzles
 Steel Reinforced



BANDLOCK Reducers
 BL-300
 All Size Combinations



Special "Y" Reducer
 Any Size



Special "Y" Plus Reducer
 Any Size



Special "Y" Plus Reducer
 Any Size



BANDLOCK "Y"s: BL "Y"
 4" to 12"



BANDLOCK Safety Discharge
 Female Coupler, Male Coupler
 BL-SFR 4" to 12", BL-SMR 4" to 12"

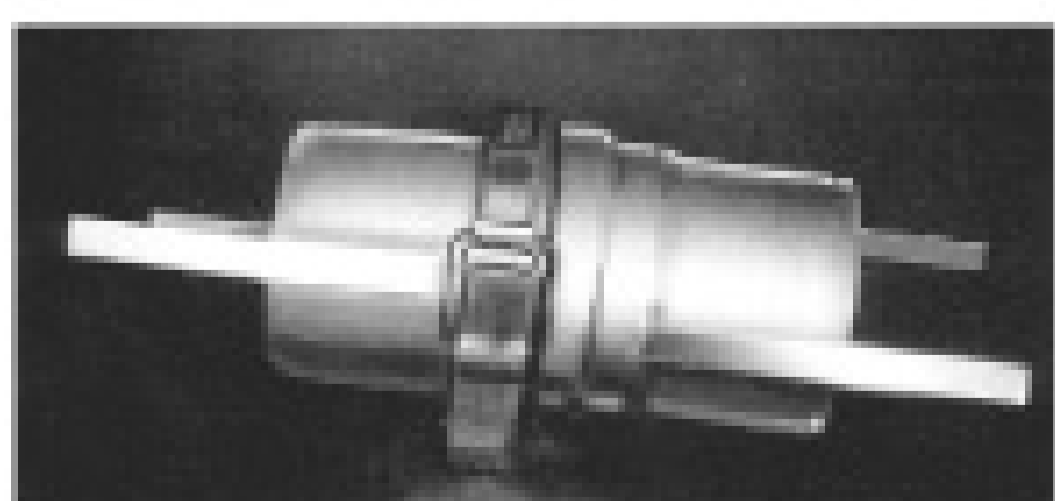

BANDLOCK Safety Discharge
 Coupler - Male Clamp, 2 Gaskets,
 Clamp with Safety Straps



BANDLOCK Clamp
 Standard and International
 BLB 4" to 12"

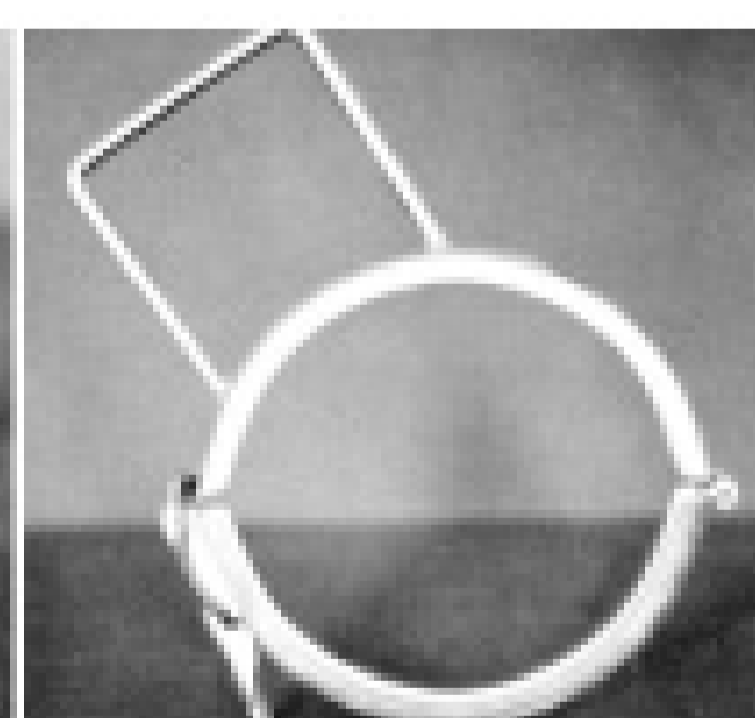

BANDLOCK
 EZ Lift Clamps
 BLB-EZ 4" to 12"

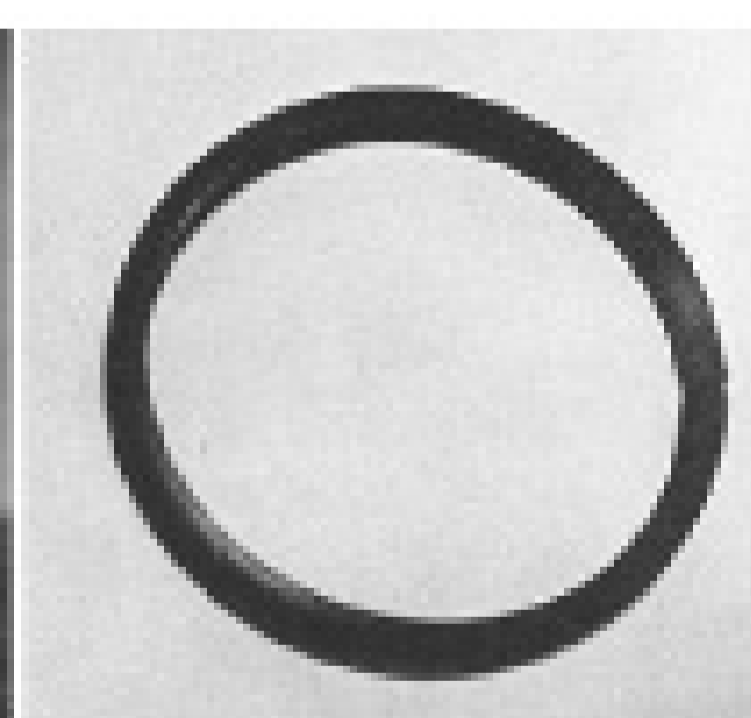

Profile Gaskets (Safety)
 4" to 12" Seals
 for Hazardous Materials



GO - 4" to 12"
 Rubber Gaskets



Male and Female
 BL-500M or BL-500F End Plug
 4", 5", 6", 8", 10" & 12"

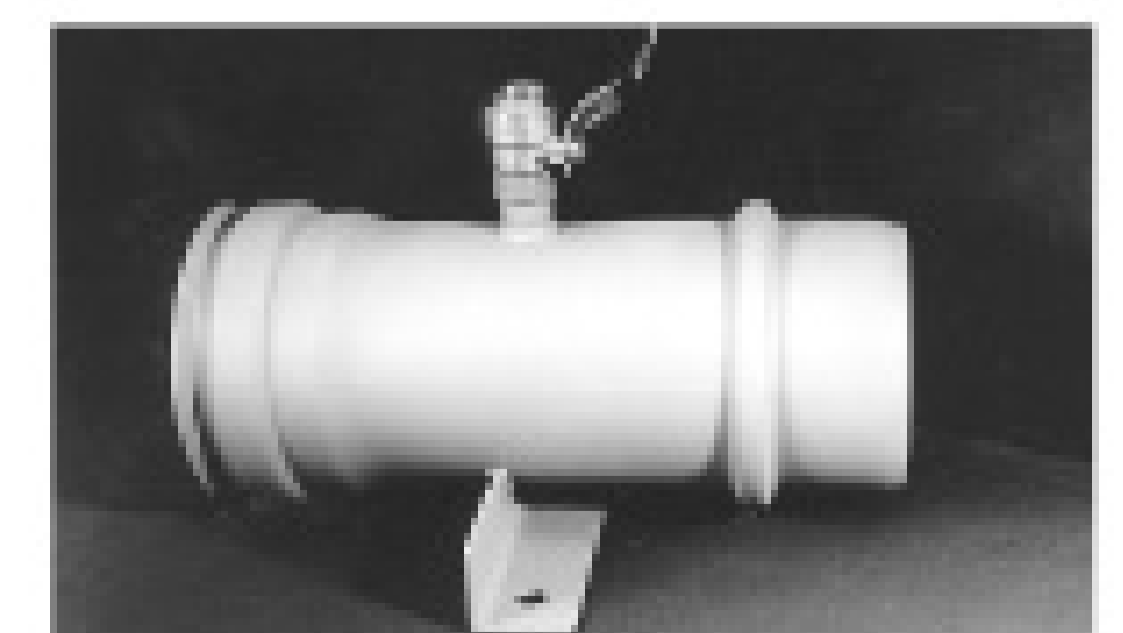

Wet Valve, 6", 360° Injected

**BANDLOCK
 Corp.**

MADE IN THE U.S.A.

SUPERIOR "QUICK" CONNECT VACUUM AND PRESSURE COUPLINGS AND ACCESSORIES

Call or fax today to get your catalog!

1-800-659-2978

Fax: 909-930-2551

www.amesbury.com

jcario@amesbury.com

Spit & Polish

From the back room to the books, you need to dress up your business to get the best price when it's time to sell

By Fred S. Steingold

It's the dream of every small business owner: selling a business someday for a tidy profit. Making that dream a reality takes time and effort.

Here are 15 ways to make your business attractive to potential buyers.

1 Show a consistent profit
Most buyers seek a business that has been profitable for at least two or three years. Let's say that three years ago your business had a great year. Two years ago you lost money. And last year's profits were only mediocre. A prospective buyer is likely to feel uneasy about what the future holds. In that situation, it makes sense to delay selling while you work on producing solid profits.

2 Resolve outstanding legal problems
No potential buyer will want to face lawsuits by unhappy customers or disgruntled employees. So if you've been receiving demand letters from an angry employee you recently fired, resolve the problem now.

3 Demonstrate that accounts receivable can be collected
You may want to include your accounts receivable in the sale. If so, you'll need to show they are collectable. Begin by putting together an aging chart that shows how long the bills have been outstanding — 30, 60 or 90 days. Eliminate any dicey accounts by settling with the slow

pays and writing off the deadbeats. The accounts that remain should have a long record of timely payment.

4 Clearly explain your business finances
Your accounting protocol should be consistent from year to year. Income, costs, and cash flow should be self-evident. A shoebox full of check stubs and deposit slips won't do the trick — nor will profits manufactured by questionable or overly aggressive accounting tactics.

5 Provide a convincing business plan for the future
The buyer will want to build on what you've done in the past and hopefully do it even better. A business plan can fire the buyer's imagination with specific ideas on where to go from here. You need one that looks ahead to a time when you're no longer in charge. It can keep the buyer's enthusiasm alive during the nervous days before closing when buyers can get cold feet.

6 Secure beneficial relationships
Good ongoing relationships with customers and suppliers can impress a buyer. But unless you can point to solid contracts, a buyer may worry that these relationships are personal to the seller and not easily transferable. If you can position the business' success as being independent of you personally, you'll get a better price.

7 Show experienced employees will stay on
Able employees can be a strong selling point. Consider offering employment contracts that commit key people to work for the business for at least a couple more years. You can also include a covenant not to compete. This can help further reassure the buyer that your key employees won't start working for a competing business.

8 Lock in your lease
The security of being able to operate the business from its current location can be crucial to selling your business. The buyer may want to lock in a lease for several years. If you rent from month to month, or your lease is running out soon, negotiate with the landlord for a long-term lease. Make sure the lease will remain in effect even if you sell the business.

9 Disclose all relevant facts
The buyer wants to be able to trust you, so disclose even negative facts. It's a mistake to leave it to the buyer to discover negative information about your business. If an exclusive contract with a major supplier is about to end, let the buyer know.

10 Spruce up your premises
Apply a fresh coat of paint. Fix broken windows and cracked tile. Get rid of clutter.

11 Make upgrades and repairs
Maybe it's time to install better lighting or signage, replace old carpets, and buy new workstations. If needed repairs are the landlord's responsibility, insist the work get done to your satisfaction.

12 Get your inventory in shape
If you have a retail or wholesale business, sell or dump all stuff that you'll never sell for a decent price. A buyer doesn't want to pay good money for inventory that can't be sold short of the local flea market.

13 Make sure equipment works
Repair or replace equipment that's not performing optimally. This especially applies to computer equipment or software that may have become obsolete. When you demonstrate your technology to a buyer, you want it to work the first time, every time.

14 Provide a clear picture of how you get compensated
You may receive a salary, bonus, fringe benefits — or all of these things. Of course, you'll inform buyers about these forms of compensation. But also be able to list all non-cash perks, such as business-related travel and entertainment, or a business car that's tax deductible.

15 Have a believable explanation of why you're selling
Few business owners just walk away from a profitable business that promises a prosperous future. Be able to convince the buyer you're selling for a good reason. Examples include retirement, starting a new career, relocating with a spouse who has a new job, or going back to school. ■

Fred S. Steingold practices law in Ann Arbor, Mich. He is the author of Legal Guide for Starting and Running a Small Business and The Employer's Legal Handbook published by Nolo. Legal strategies may vary depending on the state in which you live and the specifics of your situation. See your lawyer for legal advice.



Good ongoing relationships with customers and suppliers can impress a buyer. But unless you can point to solid contracts, a buyer may worry that these relationships are personal to the seller and not easily transferable. If you can position the business's success as being independent of you personally, you'll get a better price.

Guaranteed Credit Approval!

- ✓ **Financing, Lease & Balloon Payment Plans At Competitive Rates!**
- ✓ **Less Than Perfect Credit...OK!**
- ✓ **New Start Up Operators...OK!**

**You Are...
APPROVED!**

Refurbished! 2006 Peterbilt Model 335
Looks & Operates Like New!

330 H.P. – 10 Speed Transmission
74,000 Miles – Air Ride

New! 3600 Gallon Aluminum
Masport HXL400 water cooled pump
All standard features – large tool box

\$103,695

Monthly lease from... **\$2073**

2008 Sterling 9500 Series

410/450 Mercedes diesel, 10 speed, 18,000 front, 40,000
air ride rear, *Very heavy duty specs – loaded!*

New 4800 Gallon Aluminum Septic Moro 824 C.F.M.
Vacuum pump. All standard features – tool boxes

\$132,000 Plus F.E.T. Monthly from... **\$1619.**



Pusher axle available.

NEW! 2008 Dodge 5500

Cummins Turbo Diesel-305 HP, 6 Speed Automatic,
7,000 lb. Front / 13,500 lb.

Rear Axle, Exhaust Brake, AM/FM-CD, Cruise.
Burks DC10 washdown, Hot Shift P.T.O.

\$69,900 Monthly lease from... **\$1398**

**400 Services
FREE DEODORANT**

With Purchase Of Your
Toilet Truck or Slide-In



NOT just a another broker...

We are a Complete Sales & Service Center
...offering more than 50 years service experience.

Call Kevin. Call Matt. ...**Just Call KeeVac**

KeeVac
Industries Inc.

1835 W. Union Ave., Unit 1, Sheridan, CO 80110

866-789-9440

www.keevac.com

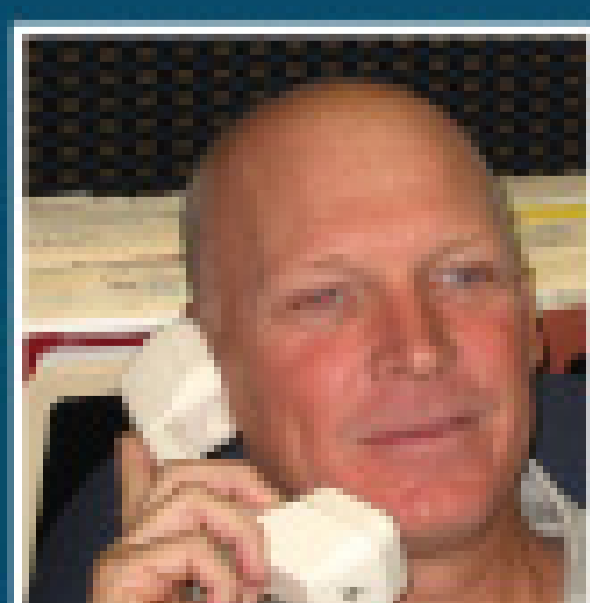

Kevin Keegan
31 Years
Experience

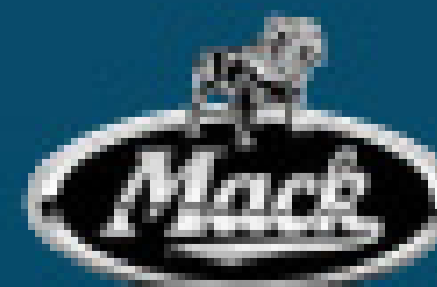
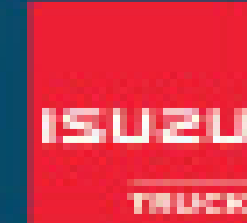

Matt Crowell
17 Years
Experience

4

OF THE WAYS

Restrooms That Last 10 YEAR WARRANTY



Deodorizers That Work EARN FREE RESTROOMS



SAFE T FRESH
Deodorizers

Protection That Pays™

WE SAVE YOU MONEY

Dependable Trucks CONFIGURED TO YOUR NEEDS



www.satelliteindustries.com

Support After The Sale IN PERSON AND ONLINE

It's easy to say we can save you money, but how do we prove it?

Satellite/Synergy World restrooms have a ten year warranty, which is the best in the industry. We warranty our restrooms for ten years because we know they will last and cost little to repair. Proof enough?

Safe-T-Fresh deodorizers, with our exclusive ROI Rewards Program, is your ticket to earning FREE Restrooms. Earn points with each purchase and cash them in for FREE restrooms. A free restroom lasting ten years generates over \$8,000 in revenue. Our customers consider that a pretty good savings.

Finally, we invest in our customers by having Area Managers in the field, a full staff of customer service representatives and online, 24 hour access, for ordering and all your account information. We provide this support because your time is valuable.

If you like saving money, call Satellite or your Area Manager for more information.

800-328-3332



SYNERGY WORLD



Imagine The Possibilities



It is time to finalize your plans for the **NAWT 3rd Annual Waste Treatment Symposium**. The Symposium will be held on **September 10th and 11th, 2008** in **Eureka, Missouri** at the **Dave Flagg's Septic Services Septage Treatment Facility**. Call Holiday Inn at Six Flags (636.938.6661) for lodging reservations, mention NAWT for our discounted rate).

This event draws a larger and larger audience each year. Make plans to attend the NAWT Waste Treatment Symposium every September to see the latest technologies and network with industry professionals.

2-Day Agenda

The Waste Treatment Symposium provides two days of opportunities to see septage and grease trap waste treatment equipment and technology presented by serious professionals.

Sept. 10: (Classroom)

Classroom session gives vendors the opportunity to present case histories of operating facilities using their technology and product presentations for participants.

(Lunch Included Both Days)

Sept. 11: (Field Trip)

Buses will carry everyone to Dave Flagg's Septic Services Septage Treatment Facility. This is an opportunity to see equipment up and running using real septage and grease trap waste. A hands-on experience makes all the difference. Tours of the Septic Services facility will also be given.

Eureka, Missouri

SEPT. 10-11, 2008

See www.NAWT.org for updates

Attending vendors include:

Aqua Ben Corp - Polymer presentation

Atlantic Dewatering - Container filter presentation

FKC Screw Press - Screw press presentation

Fournier Corp - Rotary press presentation

Big Fish - Turnkey septage treatment facility

Center Capital Corp - Financing presentation

Caremeusa - Lime presentation

Geotube - Dewatering tube presentation

Burt Waste - Oil/water separator

Juggler - Separator truck presentation

Lely - Screen presentation

Don't miss this Opportunity to learn about waste treatment technology first-hand, register today!

To Register...

Name: _____

Company: _____

Address: _____

City, State, Zip: _____

E-Mail: _____

Phone: _____ Fax: _____

Cell: _____

Registration Fee: \$225.00 – Members \$325.00 – Non-Members

Check enclosed Visa MasterCard _____

Exp. Date: _____ Name on Card: _____

Signature: _____

Fax or Send your form with payment to the NAWT office by **September 1, 2008**.



Wondering what all the JAG Shower Trailer buzz is all about?



USDA Forest Service
Compliant 32' 8 Stall



Need a shower trailer? Call the Shower Trailer experts at JAG Mobile Solutions for more information and available inventory of our industry leading shower and restroom trailers.



32' Functional Shower

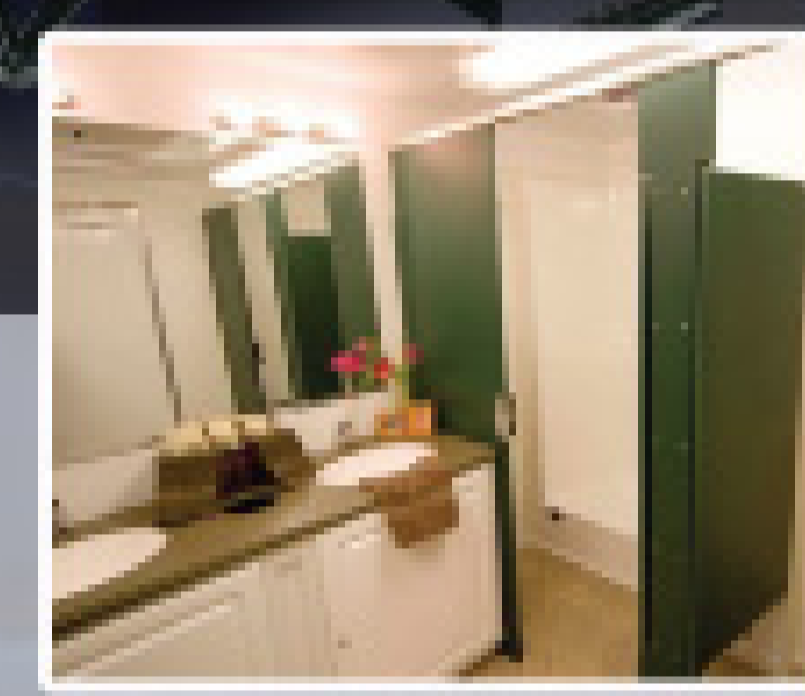

Fantastic

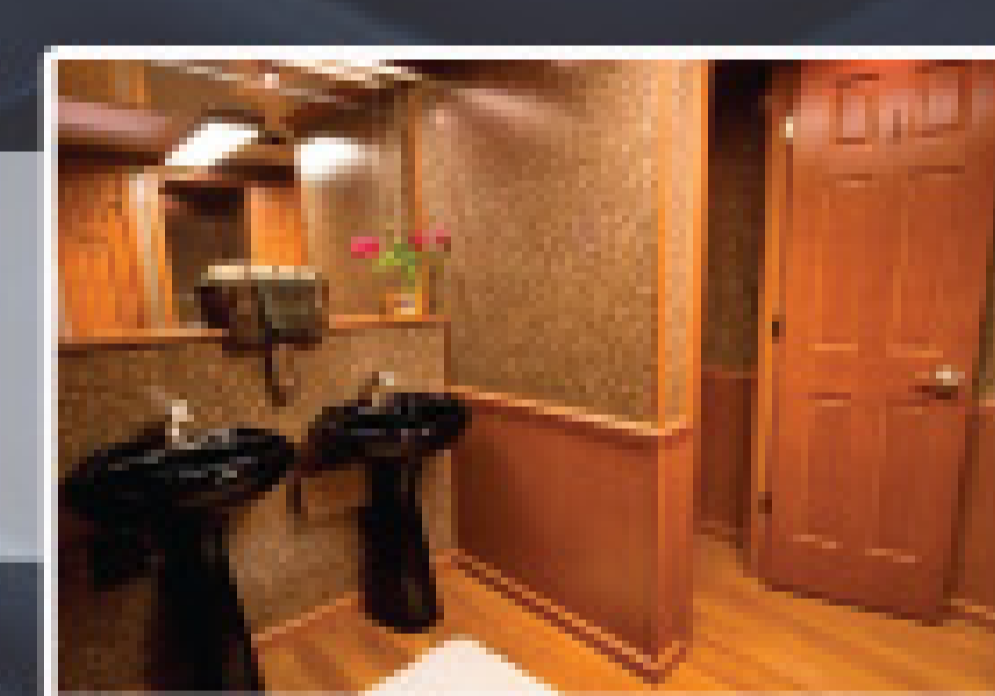
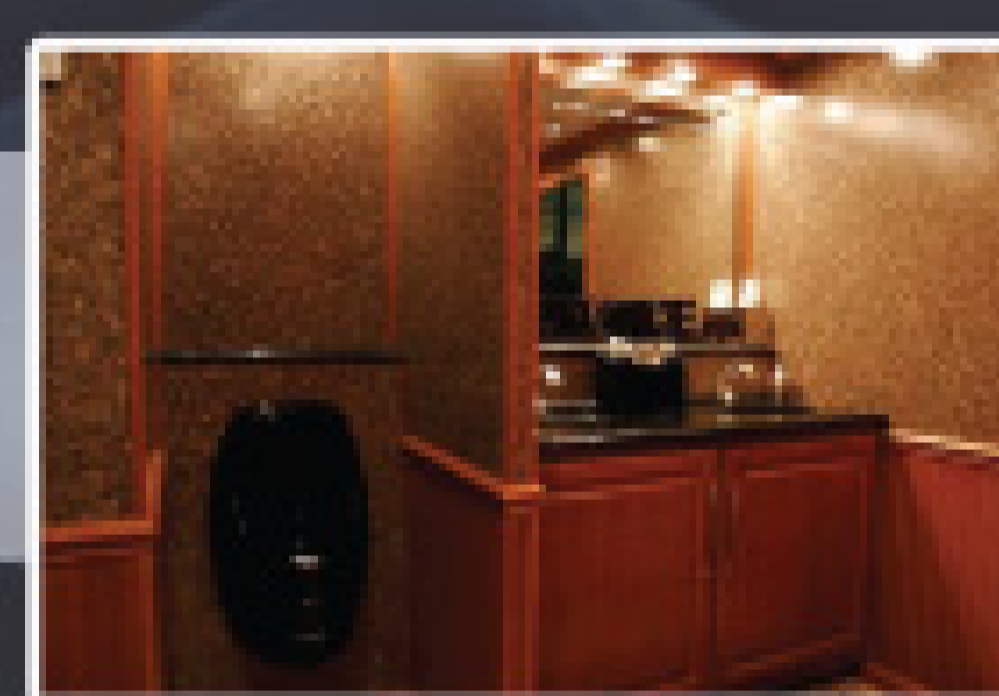

Industrial Giant

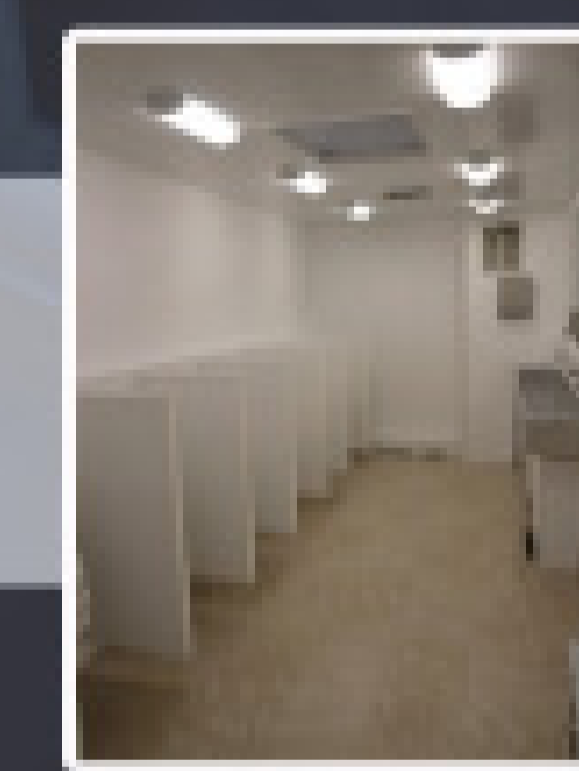

Porta Lisa Plus

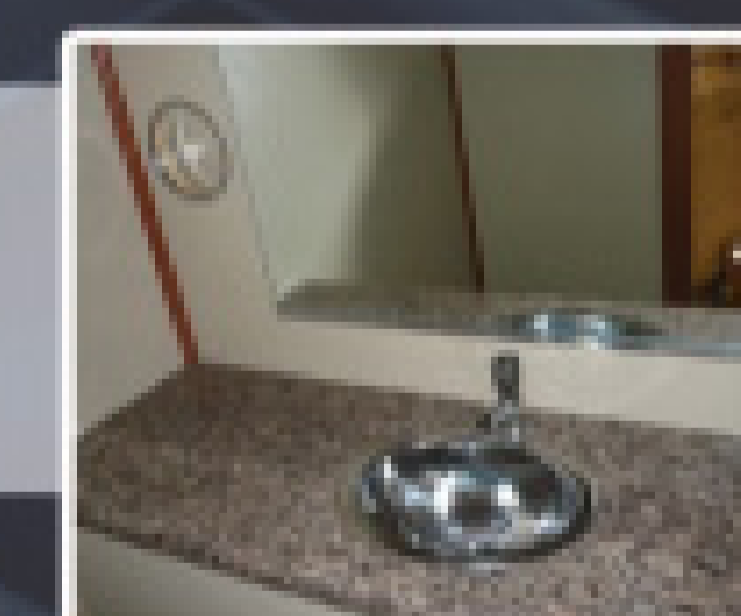
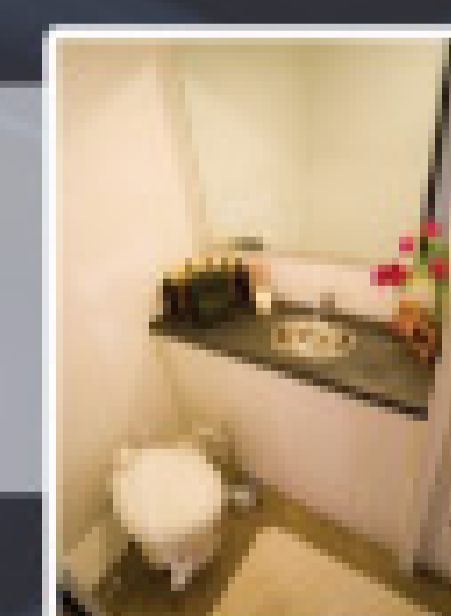
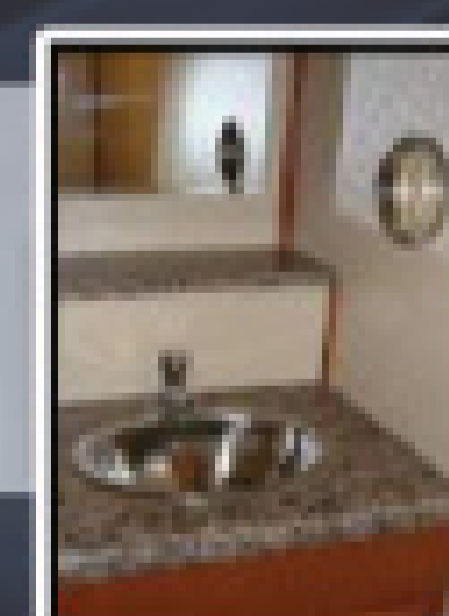
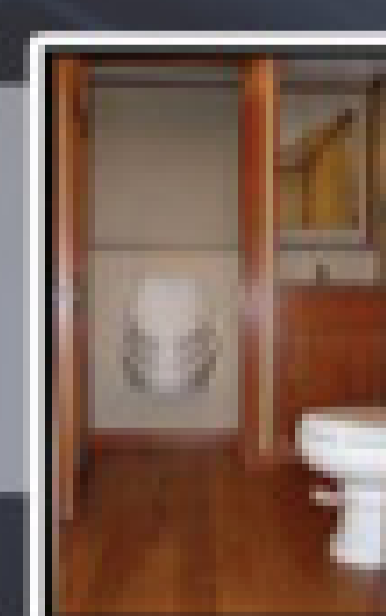

Porta Lisa

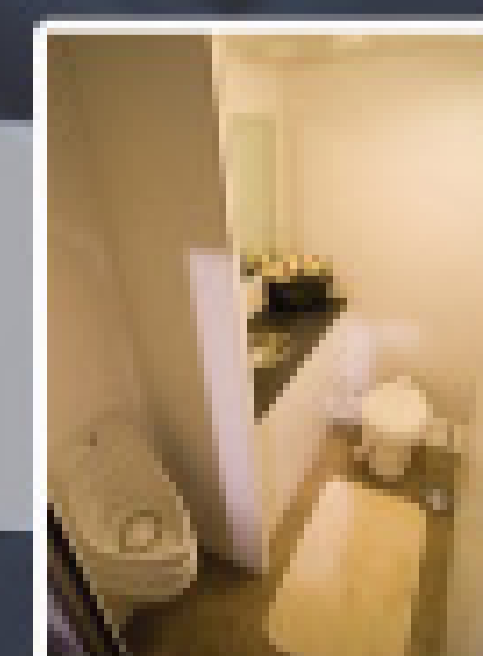
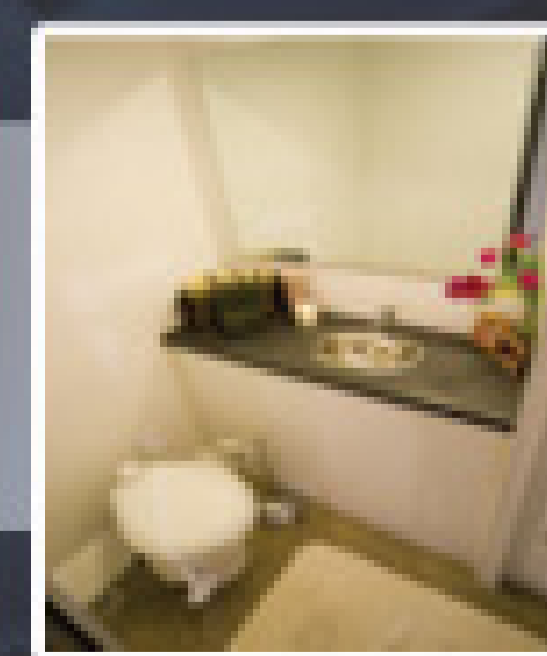

Give us a call at 800-815-2557 or stop by our brand new website www.jagmobilesolutions.com for more information about our Restroom, Shower and Specialty trailers.

The Solution For All Of Your Aluminum Vacuum Tank Needs



**5 YEAR
WARRANTY
ON NEW TANKS**



IN STOCK

7000 Gallon aluminum trailer, full length fender/hose trays, 60,000# Watson Chalin air ride suspension, polished aluminum wheels
\$59,000 + FET

IN STOCK

3,800 Gallon aluminum tank on 2000 Freightliner chassis, with Jurop PNR 142 vacuum pump, \$64,900 tax included

Longhorn Tank Co.

P.O. Box 1147

Gravette, AR 72736

800-422-9840

479-787-7910



Aqua-Zyme Disposal Systems

*"From the Grease Trap to the Garden"
- Dewatering & Composting -*

#1 Box on the market!

The ADS Dewatering System

is built by a pumping company for pumpers. You are welcome to come and watch the 30 yard box dewater 20,000 gallons of grease trap waste and/or septic tank waste in only 2 hours!

By using the ADS dewatering system along with our Compost Facility, we have turned our disposal costs into a profitable venture!

Call 979-245-5656 for Info!
\$ Financing Available \$

P.O. Box 489, Van Vleck, TX 77482 • www.aqua-zyme.com
1-979-245-5656 • zymme@aqua-zyme.com • U.S. Patent # 6,364,122



Septage & Grease Dewatering

FKC® SCREW PRESS

FKC SCREW PRESS CROSS SECTION

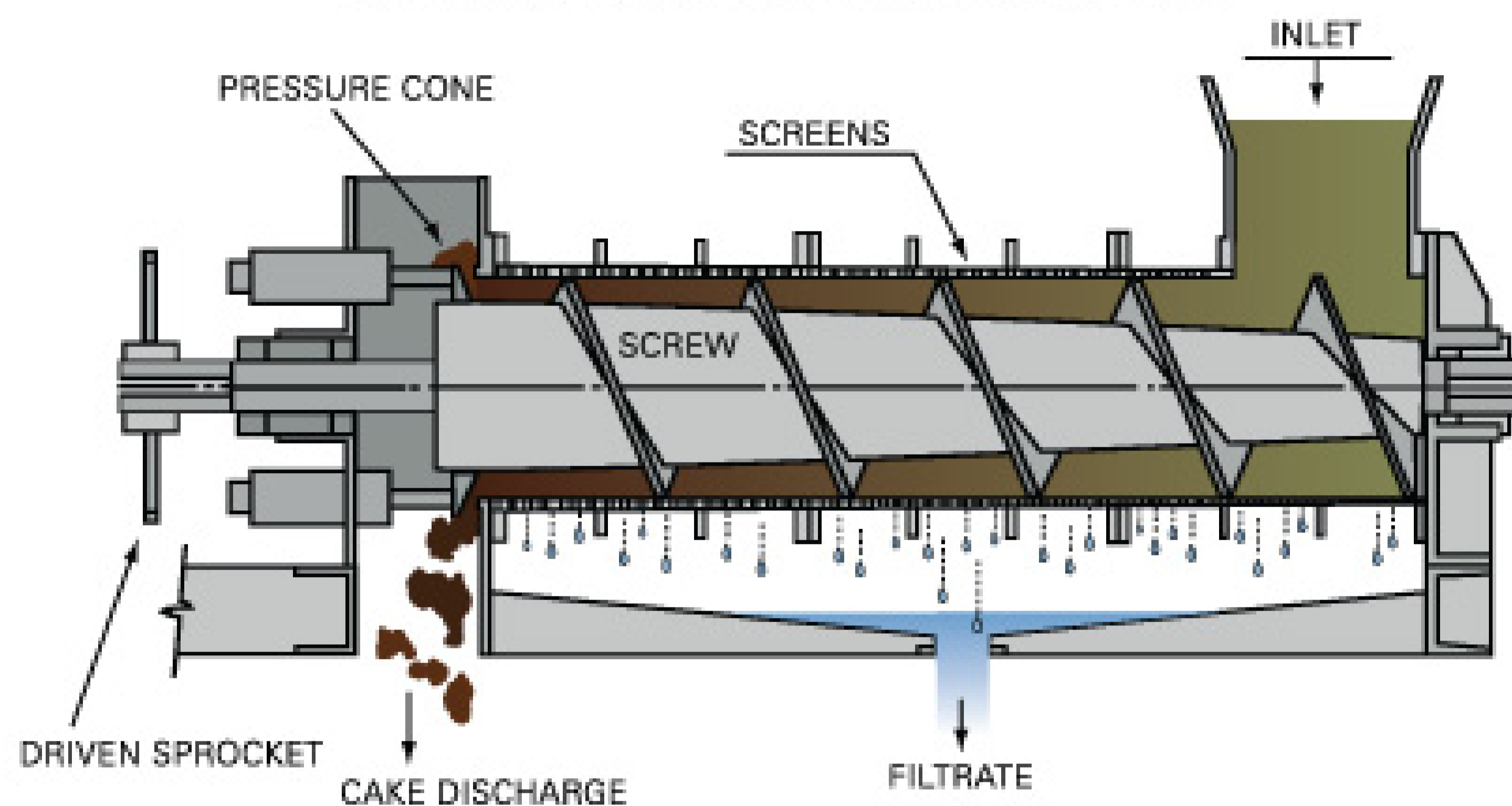

Dewatered Grease

Features of the FKC Screw Press:

- Upgradeable to Produce Class A Biosolids
- Complete Skid Mounted Systems Available
- Higher Cake Solids than Competing Equipment
- Unattended Operation
- Very Low Maintenance
- Slow Screw Speed
- Few Moving Parts

The FKC screw press is a very simple, slow moving mechanical device. Dewatering is continuous and is accomplished by reducing the volume as the material being dewatered is conveyed from the inlet to the discharge end of the screw press. FKC's advanced screw design produces a high outlet consistency while maintaining an excellent capture rate.

FKC manufactures a wide range of sizes for small to very large customers. Small screw presses are appropriate for flows as little as 3,500 gallons/day. Large presses, like the one below, can dewater over 7,000 gallons/hour. All equipment is custom designed to fit the requirements of each customer.



FKC Co., Ltd.
2708 W. 18th Street
Port Angeles, WA 98363
Tel: (360) 452-9472

Fax: (360) 452-6880
mail@fkcscrewpress.com

www.fkcscrewpress.com

When it's forty miles out and forty miles back,
Pump failure is not an option.

When you need to trust your equipment,
insist on NVE vacuum pumps.



Designed and built with the customer
 in mind – resulting in dependable,
 high performing pumps that are easy
 to install, operate and service.

www.natvac.com

800-253-5500 - 2670 Aero Park Drive - Traverse City, MI 49686

NVE
 Powerful. Performance.



Toll Free 888-207-2074

Fax (479) 770-6089

WILCOX TRUCK SALES, INC.

WILCOX
 TRUCK SALES
 770-6088 507 017

Lowell, Arkansas

... ESTABLISHED 1978

I-540 Exit #78 & Hwy 71B

2 hours East of Tulsa or 1.5 hours South of Joplin

www.wilcoxtrucksales.com



1999 Mack CH613

E7 Mack, 380 HP, 9 Speed, New 3360 Gallon Vacuum Tank, New Jurop R260 Pump, Custom Paint, 205' WB, One Owner, Fleet Maintained, AC, PS, Cruise, Ready to Make You Money

"DON'T BE EMBARRASSED AGAIN!"
 HOW AWFUL...

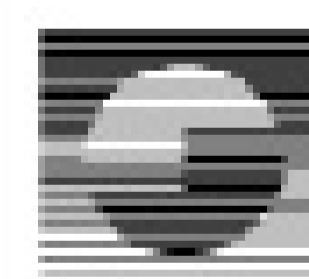

800-622-8768
sweetair.com

SWEET SEPTIC SYSTEMS, INC.
 5701 Mother Lode Drive • Placerville, CA 95667
 Fax: 530-622-1087

SWEET AIR™ FILTERING DEVICE

UPC Approved
HOW WONDERFUL...



Experience the raw power of...

SURCO®

BLUE • MUSCLE™

THE MOST POWERFUL PORTABLE TOILET DEODORANT IN THE INDUSTRY

Stock up and Order Today!

1-800-556-0111

or on the web at:

www.surcopt.com



SURCO®

– Since 1946 –

292 Alpha Drive • Pittsburgh PA 15238

1-800-556-0111 412-252-7000

www.surcopt.com



©2008 SP

Clogged Arteries

A poster wonders if he can clean out sluggish drainfield lines without the major surgery of replacing the onsite system

This feature in Pumper® reports noteworthy conversations that take place in the Pumper Online Discussion Forum for industry professionals found at www.pumper.com. The forum is split into several topic areas: General Discussion, Business, Parts & Accessories, Portable Sanitation, Pumps & Blowers, Septic System Installation, Septic System Service & Maintenance and Trucks. Simply register with a user name and password and join the discussion!

Information and advice in Overheard Online is offered in good faith by industry professionals. However, readers should consult in depth with appropriate industry sources before applying such advice to a specific business situation.

Overheard Online

CAN I EFFECTIVELY JET OUT DRAINFIELD LINES?

Question:

Can someone give me advice on using a jetter to clean a field line? Do you clean the whole line as far the jetter will go, or just the header pipe going to the field line?

Does this help the field line to start taking water? Do you give your customer any type of warranty?

Answers:

In order to help with your question, I would need a little more information. What type of drainfield line are you dealing with? Is this a pressurized drainfield line, such as in a low-pressure distribution system, mound, sand filter, etc.? Or are you dealing with a gravity drainfield with 4-inch tile, or 4-inch perforated PVC pipe? Do you know for sure that the line is "clogged?" Or is there another reason the drainfield is not accepting effluent?

If this is a LPD, or pressurized system, with 3/16-inch or 1/8-inch orifices, typically the lateral ends should be exposed and vacuumed out using a pump truck. Vacuum all of the laterals separately. Vacuum the pump discharge line as well. You may then run the jetter up each lateral line to its origin and vacuum again.

If this is a gravity type system, it is important to determine if the line itself is clogged or if the drainfield infiltrative surface and trench walls are clogged. Jetting the lines in a system that is "failing" due to clogged infiltrative surface will not likely remedy the problem. However, in some cases, vacuuming the lines using a pump truck and flushing the lines with freshwater several times can help revive the drainfield to some extent.



I'm trying to understand how a jetter works on field lines. I've heard people say they jetted the field lines on a gravity drainfield with 4-inch perforated PVC pipe and it helped the problem. I was interested in getting some feedback on how the process works and if it does help.



I do a fair bit of jetting. It often helps if the tank has been neglected and solids have been flushed into the field. I have recovered a number of fields this way. I vacuum and jet all the lines from the D-box and load-test them afterward. But you have to know the nature of the failure, and I don't attempt it unless I'm fairly certain it will help. I never give a warranty. I always tell my customers that it is a Band-Aid solution.



The few ways jetting will help a lateral is to clear accumulated debris in the line. The debris is usually from a bad baffle or poor maintenance and typically accumulates in the first part of the line. Even a high pressure/high volume jet is not capable of clearing debris that has passed through the system, through the D-box, out through the lines and down through the media to the bottom of the trench. The pipe is typically 4-inch perforated with 1/2-inch holes, and the holes will only allow so much water to pass at a given volume. At best, the water pressure will blast the media directly beneath the holes. When trenches are saturated, it is usually — but not limited to — excessive biomat formation on the trench bottom and sides. Jetting will not relieve that condition. If the trenches are failing due to poor soil conditions, poor installation or poor design, jetting will not overcome those concerns.

We see very few occasions where jetting will solve lateral problems, and we are a jetting company as well, on a small scale.

CAN YOU SUGGEST A GREASE SOFTENER?

Question:

Do you have any suggestions for a grease softener to be used in a scum pit before pumping it into a digester tank?

Answers:

I had a plumber one time tell me he would put a couple of gallons of dish soap in a pit to help break down the grease. I've never tried it, but the plumber said he has done it several times.



The dish soap will help emulsify or liquefy grease, but not break it down. Most grease trap or floor drain additives will do the same. Caustic chemicals will also work, but be aware of safety aspects.



Most biological grease trap treatments do not simply emulsify grease and send it down line. They have the ability to completely digest grease, leaving behind basic compounds such as carbon dioxide and water. Even in applications where bacteria cannot keep up with the amount of grease in a trap, its use may keep the grease from forming a

When trenches are saturated, it is usually — but not limited to — excessive biomat formation on the trench bottom and sides. Jetting will not relieve that condition. If the trenches are failing due to poor soil conditions, poor installation or poor design, jetting will not overcome those concerns.

solid, tightly packed grease cap. This will result in easier pumping. To achieve this, additives should be used regularly as a maintenance product as opposed to a quick fix.



I've heard muriatic acid will help break down solids in septic tanks and leachfields. Any truth to that? Any problems? I know it works great for taking off the concrete on portable restrooms. If it works on a septic system, how many gallons in a 1,000-gallon tank/leachfield?



Occasionally, at wastewater plants, we drain our aeration basins for maintenance. Part of this project is scrubbing the diffusers (bubblers) with muriatic acid to remove mineral deposits. Muriatic acid is simply a diluted hydrochloric acid. When we are finished, we thoroughly flush the basins to remove any residual acid. Any remaining acid could upset or even halt the biological breakdown of organic material because the bacteria only live in a certain pH range. The effect would be the same in septic tanks. Also, your local environmental regulators would not allow acid in the leachfield. ■

Steel Tanks	Aluminum Tanks
 <p>Polished Aluminum Skirting and Tool Boxes</p> <ul style="list-style-type: none"> • 2008 GMC 5500 Duramax, Diesel, Allison Automatic Transmission, 19,500 GVW, 1000 Waste, 350 Fresh \$59,000 • 2008 Ford, 6.4 Diesel, Automatic, 19,000 GVW, 950 Waste, 300 Fresh \$57,000 • 2008 Dodge 5500, Cummins Diesel, Allison Automatic, 1000 Waste, 300 Fresh, 19,500 GVW \$60,500 • 2007 Ford F750, Cummins, Automatic, Air Brakes, 2300 Gallon Tank \$74,000 • 2007 Chevrolet 7500, Diesel, Allison Automatic, Air Brakes, 1400 Waste, 400 Fresh \$70,000 	 <p>by Amthor 5/16" Thick</p> <ul style="list-style-type: none"> • 2008 GMC 5500 Duramax, Diesel, Allison Automatic, 19,500 GVW, 1000 Waste, 400 Fresh \$67,500 • 2008 Ford, 6.4 Diesel, Automatic, 19,000 GVW, 1000 Waste, 400 Fresh \$65,500 • 2008 Dodge 5500, Cummins Diesel, Allison Automatic, 19,500 GVW, 1000 Waste, 400 Fresh \$68,000 <p>• Any Brand Truck Available • Used Septic and Toilet Trucks Available</p>
 <p>Portable Restroom Trailers</p> <p>8 RESTROOM 10 RESTROOM 12 RESTROOM 14 RESTROOM 16 RESTROOM 20 RESTROOM</p>	 <p>Trailer Mount Slide-in Tank 600 gallons waste/200 gallons fresh water. \$12,500</p>
<p>SLIDE-IN UNITS & USED TRUCKS AVAILABLE / MASPORT, JUROP & CONDE VACUUM PUMPS CHECK OUR PRICES</p> <p>LANE'S VACUUM TANK, INC. 3133 VANZORA RD. • BENTON, KY 42025 800.592.3308 • 270.527.9945 RODNEY LANE'S CELL 270.832.3793</p>	

PARTNERING WITH SEPTIC PROFESSIONALS SINCE 1976 

Pumper Success Seminar: FIGHT RECESSION

As the cost of oil continues to rise, every business suffers from a shrinking bottom line. One way to fight recession is to get more revenue out of each service call. Take advantage of all possible add-ons that will add to your bottom line:

- Additional services, like jetting
- Small repairs like risers and covers
- Filters
- Additives

FUEL COSTS

You don't need us to tell you that the cost of oil is the biggest single economic headache in the world right now. Fuel costs have driven up the price of almost everything, including the cost of the services you provide.

Every time you pull up to the pump to fuel your trucks, or order something for your business that moves by truck, the oil companies are reducing your bottom line. If you ordered something a year ago that cost you \$100 in freight charges, that charge is probably now \$150 or higher. That's at least \$50 off your bottom line!

Our loss is your gain: WE PAY THE FREIGHT



All our customers know that when we ship any of the **CCLS Family of Products**, the freight charges are included. With the **FUEL SURCHARGE** currently at 32.3%, that is a significant amount of money that we leave on your bottom line.

To find out more about the **CCLS Family of Products** for residential and commercial septic system maintenance, grease waste systems, for restoring drainage, and for portable restrooms please call us toll-free at 1-800-759-2257. We'll send you our product information packet—including DELIVERED prices. There is no cost or obligation, and no obnoxious salesman will call you (a big plus with us). Please call today to see how the most effective products are also the most profitable. Thank you.

—Rick Howe, President

CAPE COD BIOCHEMICAL COMPANY

P.O. Box 990 • Pocasset, MA 02559

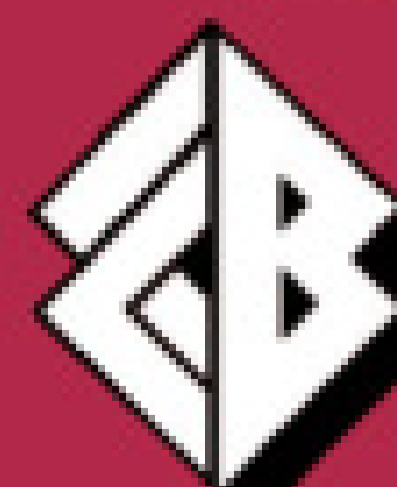

1-800-759-CCLS
(1-800-759-2257)

FAX: 508-564-9974 • www.SepticOnline.com



We pay attention to the details.

- Fabricated to the best industry standards using the highest quality products available
- Custom configurations to your specifications
- VISA, American Express, MasterCard, & Discover
- Fast, same day shipping, low freight rates



**ATLANTA
RUBBER &
HYDRAULICS**

1640 D Sands Place
Marietta, GA 30067
Toll Free: 800.282.6272
Phone: 770.955.5225
Fax: 770.955.2377
e-mail: dragsdale@atlantarubber.com

1000 Gallon Trailer Mounted Vacuum System



EXPERTS IN PORTABLE VACUUM SYSTEMS!

PACS 1000

PACS trailer mounted vacuum systems are available in a variety of configurations. PACS 1000 is designed for removing liquids, solids, and sludge from land or water. Costing less than vacuum trucks, the PACS is approved for highway towing. Integral hydraulics allow the PACS to run oil skimmers and pumps, as well as lift the tank to dump contents.



ELASTEC MiniVac

Oil Skimmer

Sucking up money for vacuum trucks

Our Drum Skimmers are optimal for rapid response oil cleanup. Extremely efficient and cost effective, they will give you an edge over competitors.



DrumIt

The drum filling vacuum head with auto shut off. DrumIt quickly connects to vacuum trucks for a clean interception of debris and liquids.



ELASTEC
AmericanMarine
Innovative Environmental Products

1309 West Main, Carmi IL 62821 USA
Tel: (618) 382-2525
Fax: (618) 382-3610
E-mail: elastec@elastec.com



www.elastec.com

PU06/08

BEST ENTERPRISES, INC.

300/110 Slide In



400/200 Slide In



3,600 gallon Stainless Steel tank on a 2008 International Truck. 3,000 Waste - 600 Fresh Water



Price Reduced While Supplies Last

400/150 Slide In



150/400/150 Slide In



Stainless Steel makes the Difference

2,500 gallon all waste - Mirror Finish Stainless Steel Tank on an 2008 International Truck.



3,200 gallon - All Waste Stainless Steel ROLL OFF TANK



We have a few (1,100 waste / 400 water) 2007 International trucks still available. Hurry now, they are going fast!



2008 Kenworth T300 with a 1500 gallon Stainless Steel Tank and customized accessories.

Custom Build



www.bestenterprises.net

Best Enterprises, Inc.
3513 W. Mt. Springs Rd.
Cabot, AR 72023

1-800-288-2378
(501) 988-1905

Safety First... We've got a handle on it!

Introducing Safety Bump™... The Solution to Transport Hose Problems



Safety Bumps™ replace traditional cam and groove caps and plugs, providing a comfortable handle for the driver's hand and a "bump" that extends beyond the hose fittings and ears, protecting them from damage. Safety Bumps, patent pending, are available in two, three and four inch, male and female models, in both hazardous and food grade configurations. Made from a glass-filled composite with antistatic additive or a food grade certified composite.



New Safety Lock™ eliminates spills due to cam lock ears opening up during deliveries. Safety Locks™, patent pending, replace unreliable Velcro straps and hard-to-operate locking cam lock ears with an easy-to-install and easy-to-remove, heavy duty 'clip' which clicks into place over the ears. **Save Your Drivers' Hands. Protect Your Fittings and Hose Trays. Safety Bumps™ now available in 2 inch.**



Safety Pumping Systems
(858) 530-8705
www.safetybumps.com
info@safetypump.com



Western Pacific Products, Inc.
"ANYTHING IN OR ON YOUR TANK"

Michigan Vacuum Trucks

Custom Built Tanks to Your Specs!

P.O. Box 234 Carleton, MI 48117



Kenworth T-300

Custom Built Vacuum Trucks to Meet Your Business Needs

All trucks are equipped with Masport Pumps
1/4" Steel Construction

Totaled Your Truck?

Rent a Vacuum Unit while your truck gets fixed

2500 gallon vacuum body ready to install on cab and chassis **\$18,000.**

Specializing in
New Vacuum Trucks,
Used Vacuum Trucks,
Toilet Trailers & Slide in Units.

Purchase a New Portable Toilet Truck for only \$45,000*

In Progress: **2003 Freightliner FL70** with a new 2500 gallon vacuum body 400 CFM vacuum pump. **\$41,000**

Call Terry at Michigan Vacuum Trucks
734-777-0390

We Can Also Mount a Custom Designed Vacuum Tank on Your Chassis!

Call for a FREE quote today!

734.777.0390

*Prices are subject to change.

Masport
NVE

MEET THE INSPIRATION FOR OUR NEWEST PORTABLE RESTROOM

**MOMS LOVE
OUR NEW
FAMILY ROOM.**



**FLEXIBLE FINANCING
AVAILABLE NOW**

Lower payments... longer terms...
less interest... deferred payments...
What do you need?

Our sincere thanks to good customers who stimulated our thoughts about the problems of parents with infants at events. That's a stressful situation to say the least.

We needed to customize one of our units to fit their needs. (No problem. We often do custom colors and modified designs for our customers.) Our new Family Room unit is the result. It turned out so well, we decided to offer it to everyone.

The new Family Room enables you to offer something new to event promoters this year. Moms love it and it's a great add-on sale for you.



Listening. Learning. Delivering. Since 1972

99 Crafton Drive, Dahlonega, GA 30533 USA • Phone (800)241-7951 or (706)864-3776 • Fax (706)864-8111 • www.polyportables.com

Only PolyPortables offers high-performance Green Way Products

TOILET DEODORIZERS • TOILET CLEANERS • AIR FRESHENERS • INSECT REPELLANT

All Green Way deodorizers, cleaners and air fresheners are earth-friendly, people-friendly products. They are developed and manufactured in our facilities in Dahlonega, Georgia by Green Way Products, a PolyPortables sister company.



Green Way Products
solutions for life

FRUITLAND VACUUM PUMPS. SIMPLY THE BEST

We are the #1 vacuum vane pump servicing the oil fields across North America.

The reason is simplicity.

**We don't need gimmicks or water cooling to serve the harshest of applications.
Simple uncomplicated design that works.**

Features:

- Every Pump "Factory Tested"
- Low Maintenance Cost
- Continuous Duty
- Air - Cooled
- No Washboard
- Vacuum to 28 hg.
- Pressure to 30 psi.
- ISO Certified
- 2 Year Factory Warranty
- Automated Lubrication System
- User friendly Maintenance Features
- Models for Tanks sizes from 1000 to 12000 Gallons
- Drive option include; Hydraulic, Direct, Belt, and Right - Angle
- Proven in all environments (sub-zero to 100 degrees plus)



Markets:

- Industrial
- Oilfield
- Septic
- Grease
- Environmental
- Wastewater

**Used and Proven by
World's Top Liquid
Vacuum Service Companies.**

**Vacuum Pump Training
Courses available*

Fruitland Tool & Manufacturing

" Committed to Quality, Reliability, and Guaranteed Performance "

Contact us today: **1-800-663-9003**
Visit us @ www.fruitland-mfg.com For more info.



DML2000

**The best Magnetic Locator
on the market**

- Easily pinpoint buried septic tanks, water valves, water meters, survey pins, iron pipes ...
- All weather operation; -20° to 120° F
- Works great in rain, sleet or snow.
- Waterproof Sensors; base of electronics to the crutch tip.
- Comes with a Hard Plastic carrying case or a soft-padded case.
- USA Bluebook P/N: 64978
- Best warranty in the business, a **LIFETIME WARRANTY**

Dunham & Morrow Inc.
43676 Trade Center Pl., Suite 145
Dulles, VA 20166 703-661-2144
www.magneticlocator.com

Lenzyme

Quality Sells ~ Sell the Best



Top-Rated

- ➔ **Premeasured Packets**
- ➔ **FREE Educational Brochure**
- ➔ **FREE Private Labeling**

BEST PACKAGING - BEST PRODUCTS - BEST PRICES



Call Today for Your **FREE** Sample

1-800-223-3083

920-826-4083 • Lenzyme, Inc.

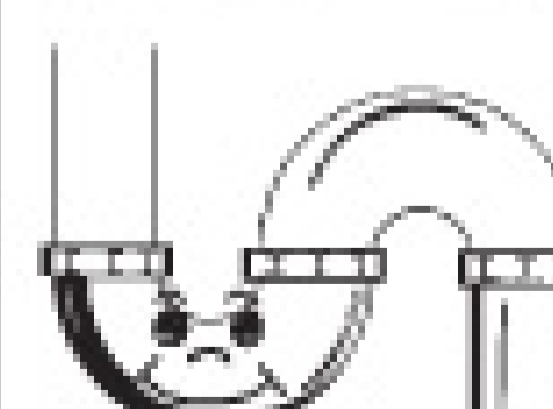

The **5**

Enzyme - Bacteria
Grease and Waste Digestant

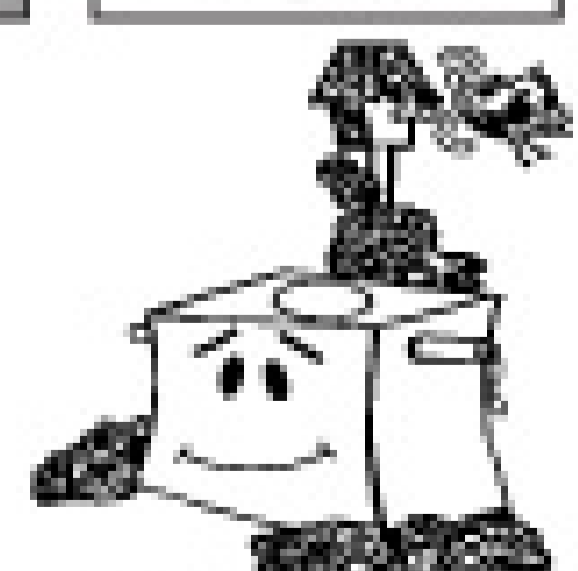

1-YEAR, 100,000 MILE ENGINE WARRANTY NATIONWIDE • COMPARE OUR TRUCKS AND PRICES TO ANYONE



2005 MACK VISION
3600 Gal US Tanks, Double Frame, 420 CFM Pump Water Cooled

2001 MACK CH613
3600 Gal New Tank, Jurap 420 CFM Water Cooled Pump. \$61,500



2001 MACK CH613
3600 Gal US Tanks, All Aluminum Rims, Jurap LC 420 Water Cooled

2000 FREIGHTLINER
3600 Gal US Tanks, Low Miles 249937, Double Frame



2005 MACK VISION
4000 Gal US Tanks, Double Frame, LC 420 CFM Pump

IN PRODUCTION
2000 PETERBILT 4500 Gal US Tanks

2000 FREIGHTLINER FL70
2200 Gal US Tanks, Ready For Delivery \$47,500

SOLD



Thanks To Karpod/Players



Thanks Again To Darling International
For Their 16th Purchase

Thanks To
Environmental & Recycling Solutions

OUR 28TH YEAR

NATIONAL TRUCK CENTER

Please Call
For More Info

ISRAEL VERA:
305-525-6406

9750 N.W. 27th Ave. | Miami, FL 33147

Phone: 305.691.8407 | Fax: 305.691.8416

GEORGE GONZALEZ:
954-558-0816

www.nationaltruckcenter.com

★ WE EXPORT OR DELIVER ★

U.S.
Tanks
THE TOP DOG OF
VACUUM TANKS

The Big Squeeze

Pumpers seek creative solutions when governments impose ever-tighter requirements for waste disposal

By Mary Shafer

Comments may be directed to Mary Shafer in care of Pumper. You may also e-mail pipelines@pumper.com.

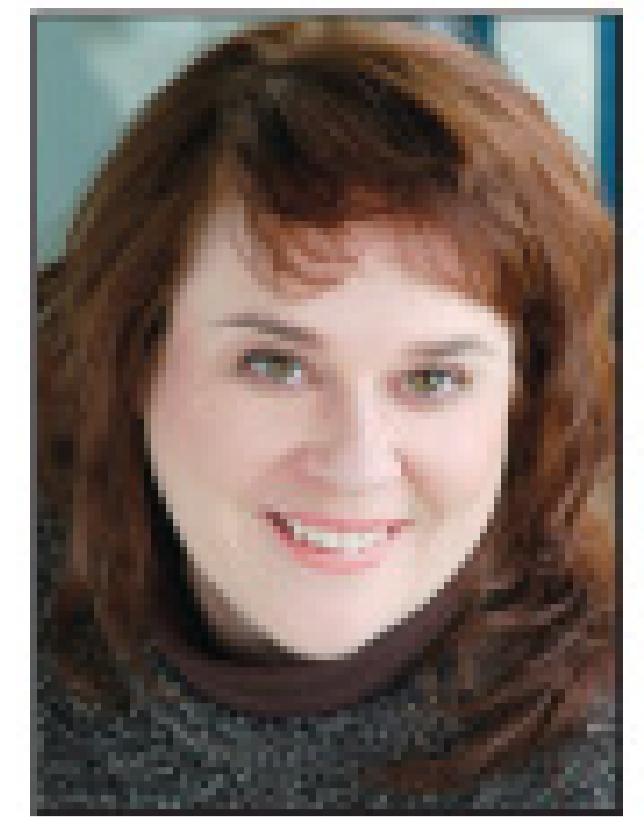

Across the U.S. and Canada, local governments continue to tighten restrictions on waste disposal. Pumpers — even those who currently have solid arrangements for land application — can no longer ignore the changing attitudes toward this practice. Every day, more ordinances are being adopted to further restrict surface waste spreading. This may be good for the environment, but it's making things tough for many pumpers. These liquid waste haulers reveal what they're doing to deal with the ever-growing disposal challenge.

"We're still currently land applying in conventional form," explains Jim Saul, owner of Central Sanitation. "Our intent is to build our own

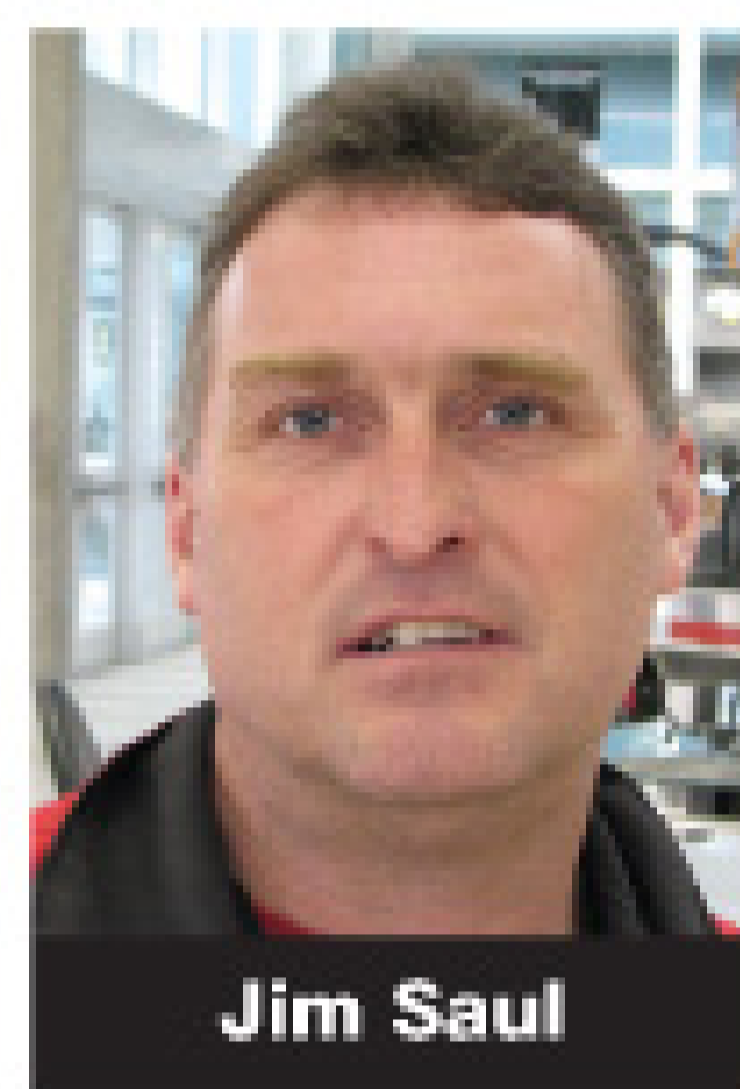

Name: **Jim Saul, owner**
 Company: **Central Sanitation**
 Location: **Sarnia, Ontario, Canada**
 Employees: **18-25, seasonally**
 Years in Business: **31**

dewatering system and discharge the effluent to a sewage treatment plant. We want to have a composting facility and then continue to land-apply those solids. We're not there yet, but that's our hope."

Saul was unable to attend last year's Septage/Grease

Trap Waste Treatment Symposium, sponsored by the National Association of Wastewater Transporters Inc. as he had hoped. He was interested in gathering information on the best dewatering option for his company's needs.

Though he's been actively planning to build his processing facility for the last decade, Saul says it could happen, realistically, in the next 3-5 years.

"Our biggest holdback is government. We're not asking for money or favors. We just need the right legislation and permits to carry it out. Unfortunately, there's a great deal of confusion at the government level about what is required and who will regulate the process."

Saul has some contacts inside the Ministry of the Environment, his province's governing body for such matters. "They are cooperative, certainly very interested in seeing this proposal move forward, but it's complicated. It brings provincial government together with municipal government, so there has to be cooperation on all sides."

Fortunately for Saul, these governing bodies will eventually have to work out a process for handling this type of application, since it's clear Central Sanitation isn't the only company in the province struggling

with disposal issues. Saul says, though, he's not satisfied waiting for government to impose something on haulers. He wants to be involved in formulating legislation so it will be something effective and worthwhile, and that everyone can live with.

It's already been a long slog for this pumper, and the drawn-out process is wearing on his nerves. "I'm a little disappointed that we've been unable to implement this plan I've had for 10 years," Saul admits, "but that's why I stay current on new technology. Even in the years since I started thinking about this, dewatering technology has really changed so much."

Kendall Todd owns Atlantic Pit Service Inc. and his struggle was what to do with grease trap waste, which isn't allowed to be land applied in his home state of Georgia.



Name: **Kendall Todd, owner**
 Company: **Atlantic Pit Service Inc.**
 Location: **Lawrenceville, Ga.**
 Employees: **14**
 Years in Business: **32**

"There are four or five disposal plants in the state of Georgia that accept waste from other people. I was taking it to another gentleman who owned a plant, and we decided we wanted to hold our own destiny by controlling our costs."

This decision was already in the works when the state issued new FOG (fat, oil, grease) regulation, which Todd says "eliminated a lot of the pump-and-dumpers." All pumpers now had to create a hauling manifest for their loads so waste could be tracked. "We'd always manifested our loads, but now it was being required and everyone had to show what was happening to their material. It helped," Todd says, to level the competitive playing field for all pumpers.

When all disposal factors were weighed, controlling costs ultimately meant building his own treatment facility. "We started looking for property, then had to go through the whole permitting process, which took about a year." In another year, the facility was ready for business. It includes two Auto-Vac rotary water vacuum systems (Alar Engineering Corp., www.alarcorp.com) — to remove 90 to 95 percent of the liquid from the septage and grease waste. The dewatered cake is trucked to a landfill, and the clarified effluent is recycled back into the plant for use in equipment prep/cleanup and other processes. Todd's company accepts waste for processing from other pumpers, adding another revenue stream.

Todd is satisfied with his decision to bring disposal in-house. "It's working pretty good for us," he says.

"A lot of people around here still land-apply," says Tony Johnson, co-owner of Johnson Septic Service, "but they're starting to sway toward the treatment facilities that are starting to pop up." Having to use a treatment plant for disposal isn't something that concerns him or his wife and business partner, Theresa Johnson. They still land-apply, as

"Our biggest holdback is government. We're not asking for money or favors. We just need the right legislation and permits to carry it out. Unfortunately, there's a great deal of confusion at the government level about what is required and who will regulate the process."

Jim Saul

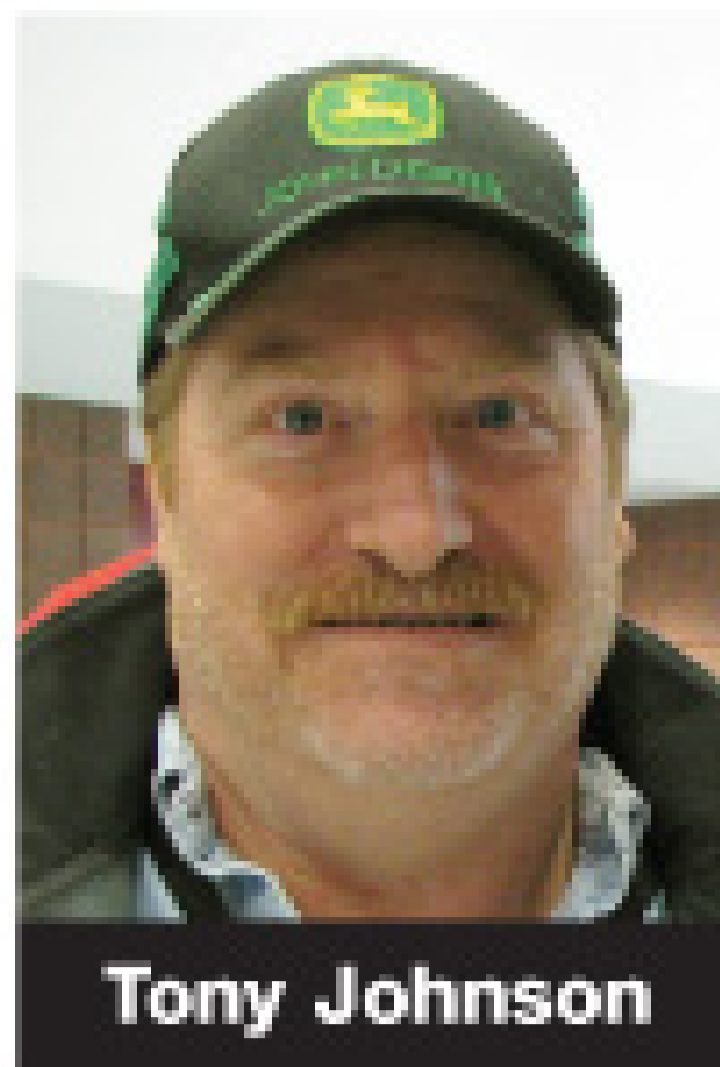

Name:
Tony and Theresa Johnson, owners
Company:
Johnson Septic Service
Location:
Sears, Mich.
Employees: **2**
Years in
Business: **14**

well as perform soil injection and make use of a waste storage tank. The Johnsons don't expect to ever have to worry about disposal again, unless restrictions really tighten up. Why? Because they own the farm fields used for land application.

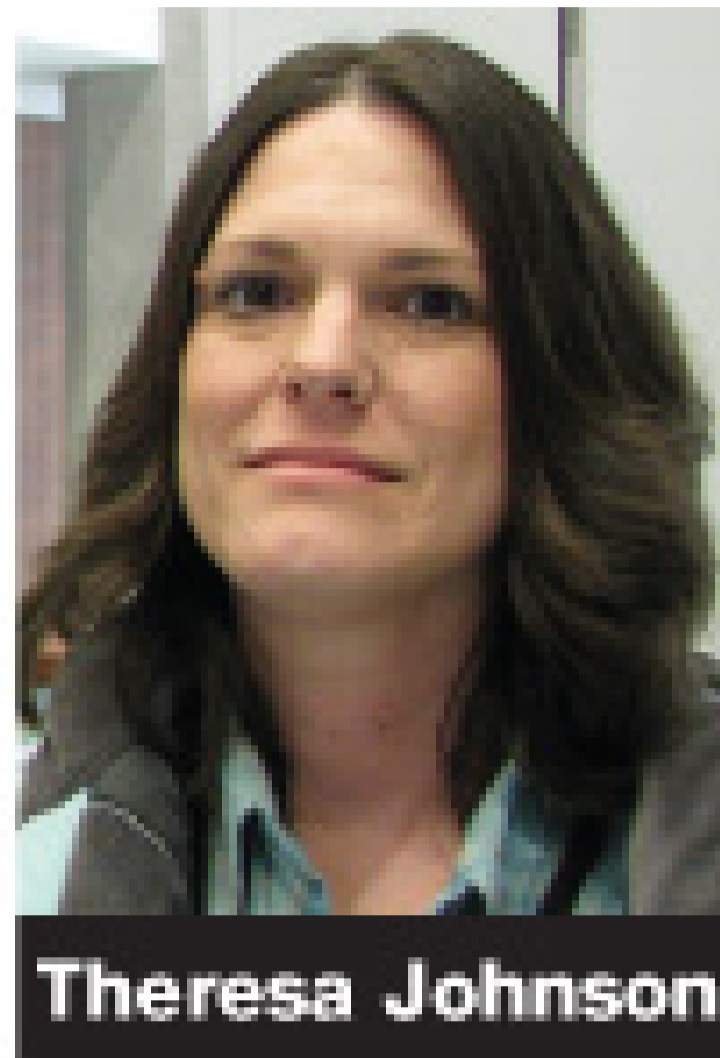

Several years ago, the state tightened regulations for disposal, driving up the cost of plant treatment and making many of their application options disappear. The Johnsons did the math and decided it would be worth the cost to buy their own farm, so they wouldn't have to worry about waning field opportunities.

Now, they're active in farming as well.

"We kind of got swayed into it when we bought the place," Tony Johnson says. Happily, the couple realized two unexpected results from the move. Their land application provides an endless supply of free fertilizer for their crops, and the income from farming has helped diversify their business. It's a nice cushion against declining fortunes in either industry. ■



We've got you covered



**New 2008 Liquid Vacuum Tank, 3,000 Gallon, DOT Spec, Fruitland 500 Vacuum Pump (350 CFM)
2 TO CHOOSE FROM!**



**ID# 71050 Guzzler Classic 1999,
Roots 1024 Blower
CALL FOR DETAILS!**



**ID# 18649 2004 Vactor Hydro Excavator,
Dual Stage Fan, Telescoping Boom
CALL FOR DETAILS!**

Many More Units Available • Call for Details!

**Parts and Service
Financing for Used Equipment and Service
Warranties for Most Equipment
We Sell and Service**

**The Largest Selection of Refurbished
Vacuum Trucks in the World**

**1-800-822-8785
www.fssolutionsgroup.com**

Simple Solutions
DISTRIBUTING LLC

**Wolverine Brand Vent Filters
Stop the Stink Guaranteed!**

UPC Certified IAPMO Lab Tested Model #WLV-4
Odor Adsorption Filters For: Plumbing and Septic
Vents, Lift Stations, Sewer Line Vents, Manholes
and Industrial Applications

**Introductory Price
Save 20% to 40%**



**Also Available,
Manhole Odor Inserts**



973-846-7817 Toll Free: 866-667-8465
www.IndustrialOdorControl.com www.StopSepticOdor.com



POWER BOOSTER

Patented Technology for Pumping

PL Pressure Lift Corp

- REDUCE PUMPING TIME
- INCREASE VERTICAL LIFT CAPABILITY
- INCREASE VACUUM PUMP PERFORMANCE
- DECREASE WEAR ON PUMP & EQUIPMENT

CALL TODAY
FOR A
FREE
DEMO DVD

Pump Deeper – Pump Quicker

972.355.0550

www.pressurelift.com

Introducing the Most Durable
and Economical Septic Lid in
the Market Today.

Cost Effective
6 Pack
Shipping

Now Offering
Custom
Lids!

- Durable Roto-Molded Construction
WILL NOT Crack Like Concrete!
- Lightweight Polymer is Easier to Handle & Transport
- Corrosion Resistant Stainless Steel Screws Included
- For use with Standard 18"
and 24" I.D. Corrugated Pipe
- Easy Slide-in Installation
- Optional Sand Filled

Roto Solutions

800.868.0973

Don't Waste Money On Expensive Riser Systems!

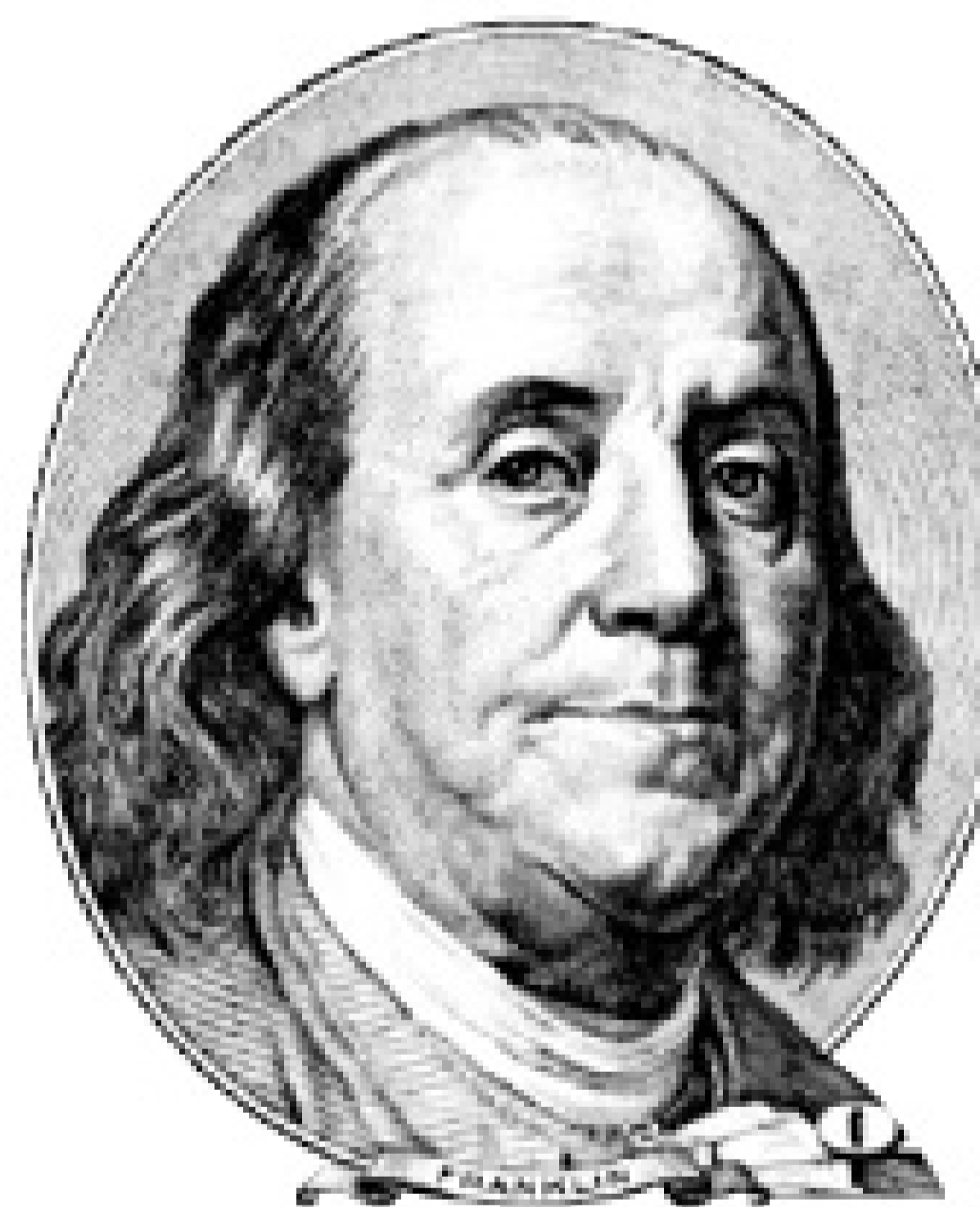

You'll be
seeing
more of
him!

*We finance all types of equipment.
We offer a variety of terms, all designed
to meet your cash flow and/or tax needs.*

Community Leasing Associates, LLC

1-877-459-5770

www.clalease.com



The Friendly Finance People

Wee Engineer

WITH IMAGINATION



Call us for a quote...

...Vacuum Trucks, Portable Toilet Trucks, Trailers



2001 International 4900, DT466, 210HP, 33,000 GVW, 7 speed, 236,000 miles
NEW 2300 gallon carbon steel tank with 3-inch inlet, 4-inch outlet, rear and top manways
 Price**\$42,900**



2000 Sterling, Cummins N-14-425 HP, 10-speed, 52,000 GVW, New red paint, only 324,000 miles, PS/AC, Cruise. Very nice. **New 3300-gallon tank**, carbon steel, and a **New NVE 367 Challenger pump**, 342 CFM, gearbox driven.
 Price.....**\$59,800 + FET**

- Custom Design to your Specifications
- Carbon steel, Stainless, Aluminum tanks
- Portable Toilet Trailers
- Parts—Pumps & Rebuild Kits, Valves, Manways, Heated Collars
- Used Trucks, New Trucks, or Your Truck

Best Heavy-Duty Portable Toilet Trailers on the Market

24ft....\$8,400
 28ft....\$8,700
 34ft....\$9,678

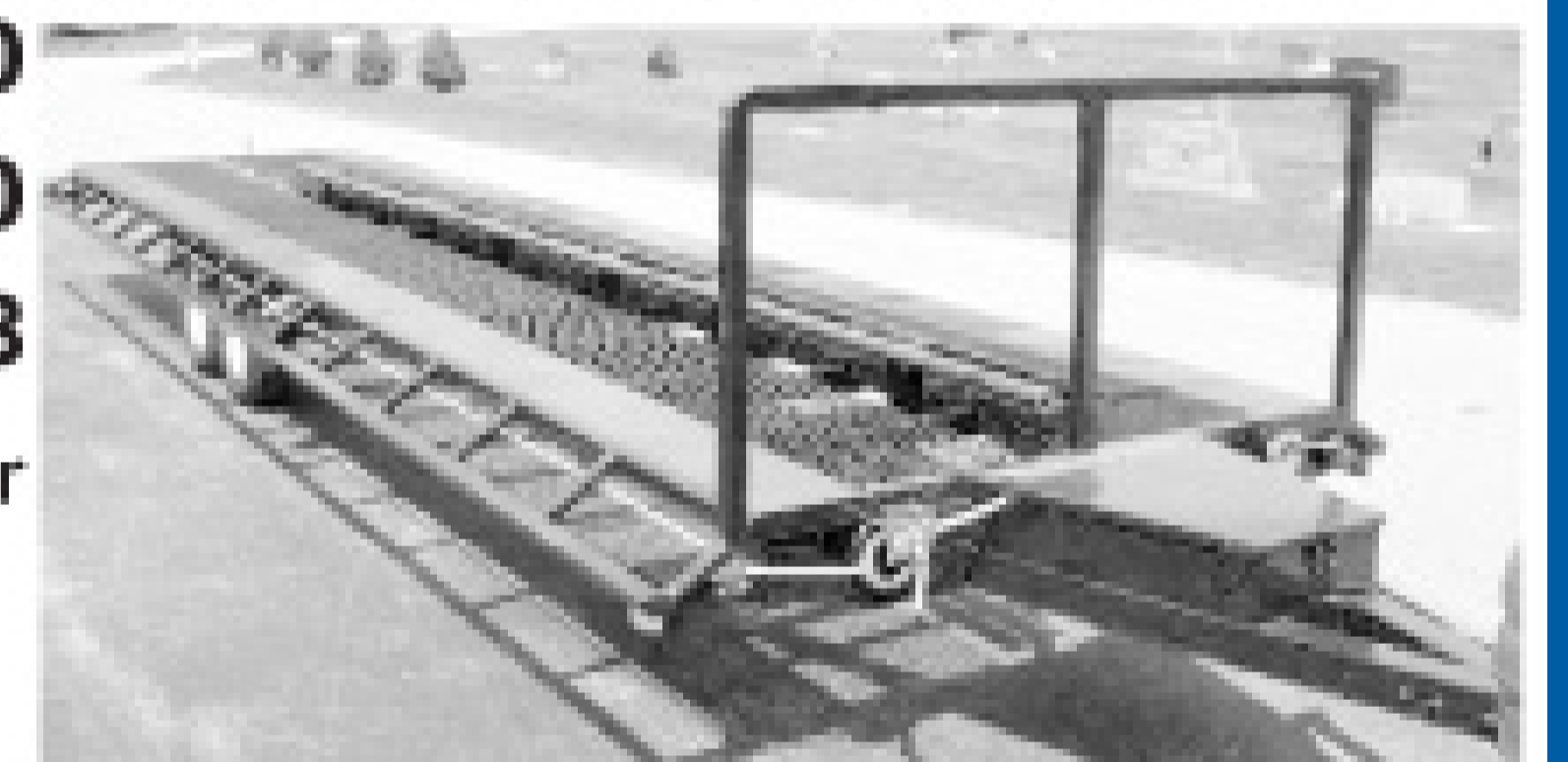

Please go to our web site and click on available units for more pics and info.

Wee Vac



No more 3" sewer hoses running through restaurants. The Wee Vac fits through a standard doorway and can pump up to 45 gallons at a time. Wee Vac will even go up and down stairs when empty. It has a 3" female cam-lock so it can be downloaded into your truck. It features a 1 1/2" hose with wand & a 105 cfm, 110 volt vacuum pump.

Price: **\$1060.00**

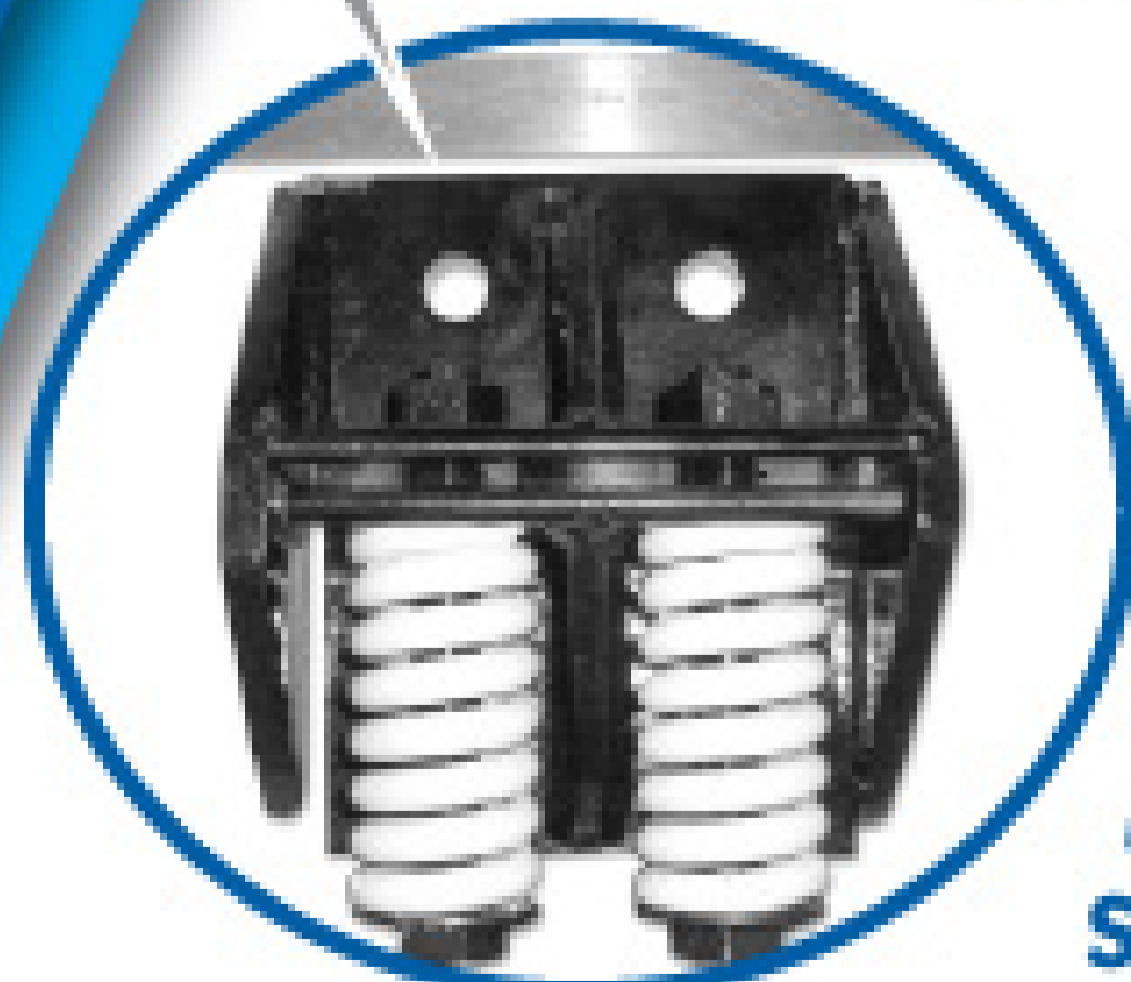

SPRING MOUNTS decrease fatigue on your tank frame, universally mounts to most tanks, Easy bolt or weld on style, Compact, Heavy-duty stress relieved springs.

Mounts with springs..\$80.00
 Springs alone\$10.00 each



Thank you to these valued customers for purchasing our portable toilet trailers this past month:

- Bob Drayton, Inc**28 ft trailer
- Portable Sanitation**34 ft trailer
- Nacirena Industries**28 ft trailer
- National Construction** ...34 ft trailer

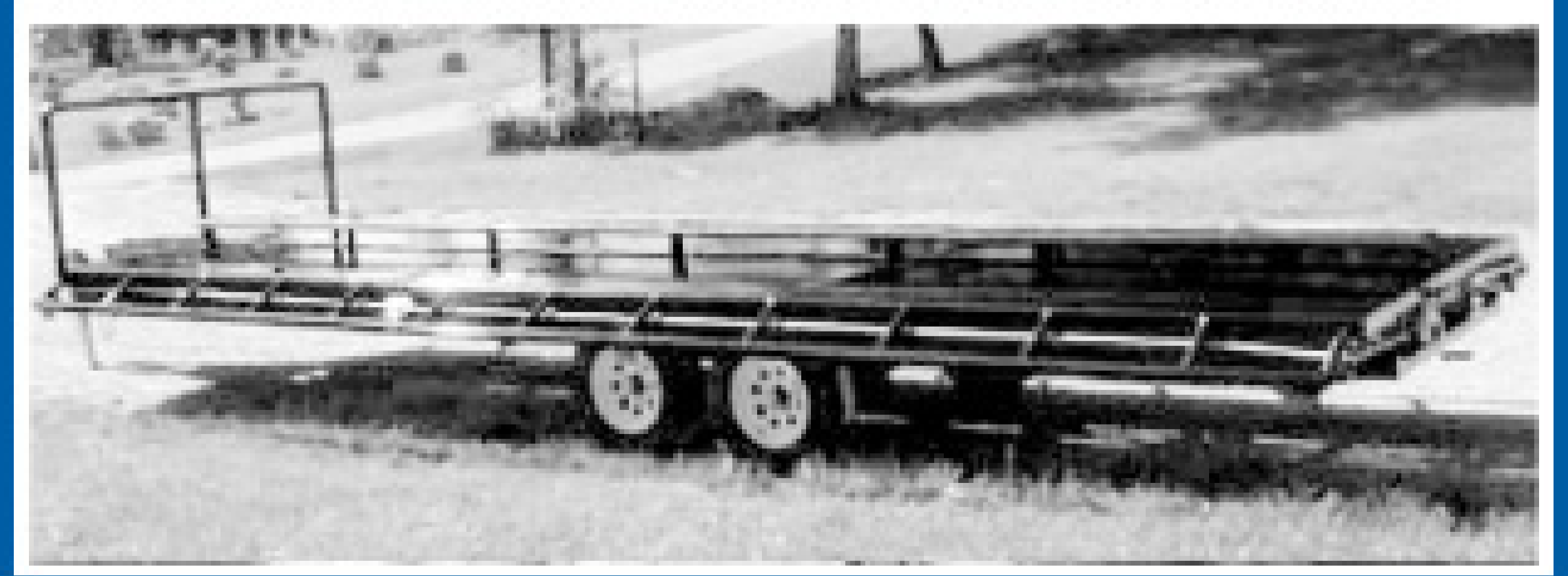

PUMPER WAREHOUSE STORE

REBATE CHECKS ARE IN THE MAIL!

VISIT US ON THE WEB! VARCOPUMPER.COM

BRASS LEVER VALVES



3" \$112.95

4" \$169.95

6" \$299.95

NOZZLE VALVE WITH EXTENSION



2" FULL PORT

\$46.80

GET MORE FOR YOUR MONEY
SPEND WITH US!

BULK EPDM SUCTION HOSE

MADE IN USA GREEN & BLACK AND YELLOW & BLACK

BULK 100' ROLLS LOW PRICES!

	2"	3"	4"	6"
	\$1.79	\$2.99	\$5.35	\$11.05
	\$1.69	\$2.89	\$5.25	\$10.95

BANJO POLY VALVES

3" FULL PORT
\$79.95



EPDM SUCTION HOSE CPLD MALE X FEMALE

3" X 20'	\$96.25	\$79.95
3" X 25'	\$115.75	\$94.95
3" X 30'	\$134.95	\$109.95
3" X 33'	\$146.95	\$119.95

VARCO FLEXI-JOINT

NO MORE BREAKING OFF AT THE TRUCK!



3" **\$51.99** NEW SIZE! 4" **\$65.99**

ALUMINUM FEMALE X MALE REDUCER



3" X 2"	\$17.85
4" X 3"	\$26.52
6" X 4"	\$45.95

DUCK BILL NOZZLES

2" \$89.95	\$79.95
3" \$89.95	\$79.95
4" \$101.95	\$93.95

NEW LOW PRICES!



FREE CATALOG



LOW, LOW PRICES - SAME DAY SHIPPING - FAMILY RUN!

TOLL FREE **866-872-1224**

SOURCE KEY
6P8

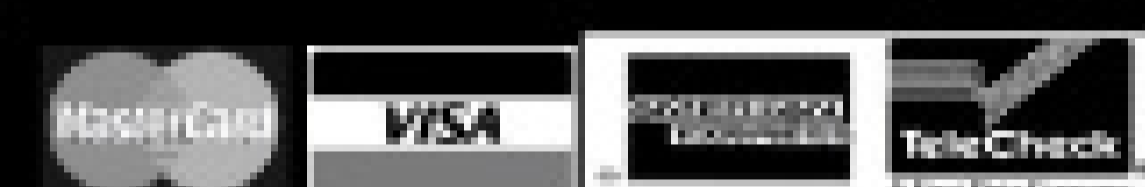

LIBERTY PUMPS



Omnivore LSG 200 Residential Grinder

We Carry a Full Line of **LIBERTY PUMPS** which come with a **2-year warranty**



280-Series Mid-Range Effluent Pump

Regenair® R3105-12 Blower \$425

Hydromatic, Zoeller, ABS, Liberty & Myers Pumps

Sutorbilt & Roots Blowers

SDS From 70-180 cfm

DC-STAINLESS Washdown Pump

Moro PM80 Turbo 350 cfm

Moro M3 176 cfm

Moro M-10 230 cfm

Flagg-Air Model 340 \$325

- 3450 rpm
- 1/4 hp, 115V
- Enclosed motor
- Stainless steel shaft
- High impact plastic parts
- Operates quietly
- 2-yr. warranty
- Fits in place of most original manufacturers' units
- Replacement parts available

The Flagg-Air 340 does not carry the NSF seal. Check local and state regulations for approval in your area.

MEDO Piston

LA-60B	\$275
LA-80B	\$300
LA-100B	\$445

SECOH Diaphragm

EL 60	\$255
EL 80	\$300

0523 Rotary Vane Compressor \$315

Moro Pumps: from 176 to 1642 cfm



Septic Services, Inc. toll free 1.800.536.5564 • 636.583.5564 • fax 636.583.6432

e-mail septic@fidnet.com • web www.septicserv.com

2008 V.E. Enterprises 'Raptor' Bobtail Tank



Why Choose A V.E. Enterprises Bobtail Tank?

Ten good reasons:

1. ***Built by ASME certified welders***
2. ***All vertical welds are sub-arc welded providing 100% penetration***
3. ***ASTM SA-36 grade 1/4" steel barrel, heads and baffles***
4. ***Barrel padded with 1/4" plate at all contact points***
5. ***4" channel ring supports on barrel for 90, 100 barrel models***
6. ***Wider hose troughs with standard rear hose hooks***
7. ***Wedge shaped sump or loading lines with 4" butterfly valves***
8. ***Trailers prepped with steel shot blast creating a 2.5 mil anchor profile***
9. ***Primed and painted with DuPont Imron for the ultimate in durability***
10. ***Built for and by our customers; call us for available options***

* Available in sizes from 60 to 100 barrels; turn-key installations available through VE authorized dealers

Setting the Standard For Liquid Storage and Transport Markets Since 1987.

800-234-2329

**www.veenterprises.com
sales@veenterprises.com**

10834 St. Highway 53 • P.O. Box 369 • Springer, OK 73458

VE
ENTERPRISES, INC.

When it comes to quality and customer service, we're on target.



Amthor is Expertise

Looking for a new tank? Think Amthor.

At Amthor, we deserve our reputation for quality, innovation and expertise.

Our products meet the demands of today's consumer AND exceed industry expectations.

With a nationwide distribution network, delivery is simplified.

And, you'll enjoy exceptional customer service.

Visit us online for specific product information.



Amthor Matador Run-About



www.AmthorInternational.com

For your nearest distributor contact: Hank Vanderveen

VA Office: 434.656.6233 • Tel/Fax: 252.293.1284 • Cell: 845.494.0104

100% FINANCING AVAILABLE

• No Financials Required

Application Only to \$250K

• No Age Restrictions

Used Equipment (30+yrs still ok)

• Seasonal Payment Plans

- Bucket Machines
 - Cable Machines
 - Catch Basin Cleaners
 - Combo Sewer Cleaners
 - Dewatering/Composting
 - Hydro Excavators
 - Jetters
 - Liquid Vacuum Trucks
 - Trailer Mounted Combo
 - Sweepers
 - Vacuum Loaders
- and much more.....*

• Working Capital

Start-Ups Welcome

• Sale Leasebacks

Simple One Page Application

• Private Party Sales

ACG IS A FULL IN-HOUSE LENDER. OUR TEAM OF PROFESSIONALS PROVIDE SAME-DAY DOCUMENTATION AND FUNDING. LET US STRUCTURE A PROGRAM THAT BEST FITS YOUR BUDGET WITH INSTANT CREDIT DECISIONS. LESS THAN PERFECT CREDIT (FICO 580+) IS APPROVABLE!

Your Pumper Team!

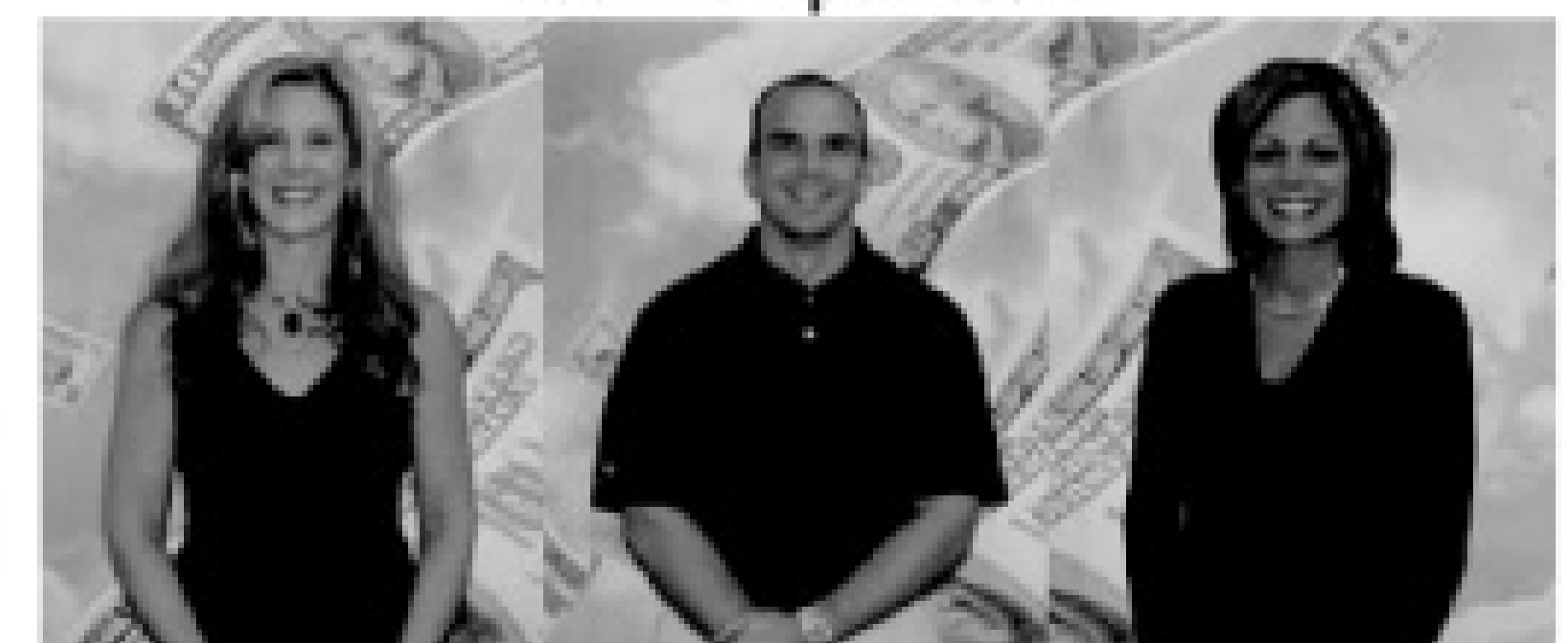

Cindy

Bryan

Ronnie

For details call: **866-806-4603**

9436 Hamilton Dr. • Mentor, Ohio 44060 • Fax 800-830-9855 • www.1acg.com

*Join forces with Five Peaks Technology...
for a product line that passes with flying colors!*



**Call today for your free catalog!
866.293.1502**



The Five Peaks product line includes the popular and stylish Aspen and K2 (available in standard, flushing and elite models), the Alpine, the Matterhorn (ADA Compliant), inside sinks, portable hand-washing stations, sanitation products and accessories, deodorizing products, and service trucks. Contact us at 866-293-1502, our Regional Sales Managers and Customer Service Representatives are available to assist you with all your portable sanitation needs.



1790 Sun Dolphin Drive • Muskegon, MI 49444
Phone: 231.830.8099 • 866.293.1502
Fax: 231.739.2131 • www.fivepeaks.net



No COMPROMISE



Don't accept a substitute for quality. The Burks DC-10 is still the most popular, high volume washdown pump available.

With flow rates to 20 gpm and pressure to 40 psig, the Burks DC-10 is the pump of choice for filling and washing your portables.

Contact your local tank manufacturer for more info, or call us toll-free at:

800-699-7557

**ARMSTRONG
EQUIPMENT
INC.**

11200 Greenstone Ave. • Santa Fe Springs, CA 90670
562-944-0404 • Fax: 562-944-3636

www.vacpump.com

Inventory of New & Used! ***We Build Pumper Trucks***

1,500-3,400 Gallon Vacuum Trucks

Featuring a 1500 Gal. Gooseneck Vacuum Tank

Financing starting at \$293/month



Redneck Trailer
Parts Dealer



Moro Pump
Dealer

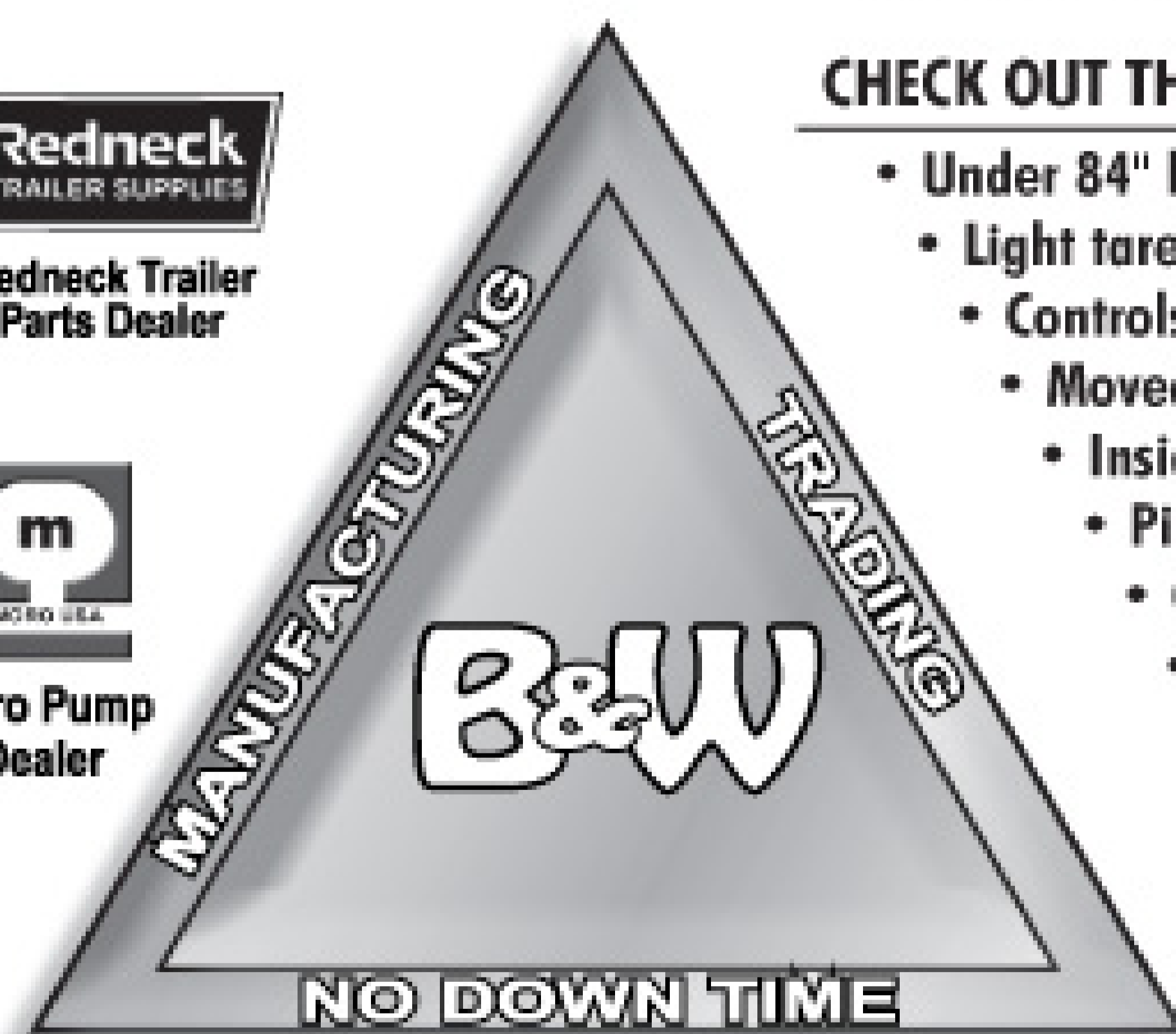

CHECK OUT THESE OPTIONS:

- Under 84" height
- Light tare weight
- Controls operated from ground level
- Moveable axles to distribute weight
- Inside tank coating
- Pintle/ball hitches
- Choice of brake systems
- Any brand of vacuum pump



Trailers are NHTSA Certified



ALL TANKS ARE MADE IN THE USA
ALL TANKS ARE COMPLETED AND THEN PRESSURE TESTED



B&W MANTRAD INCORPORATED
4000 E. Jackson • Macomb, IL 61455
309-837-1989 • fax 309-837-1919 • bandwent@macomb.com

**40 Years
Experience**

***B&W .. Because Nobody
Has Time for Down Time***

**CALL TODAY
FOR INFORMATION OR PRICES
ON TANKS, PUMPS AND ALL PARTS**

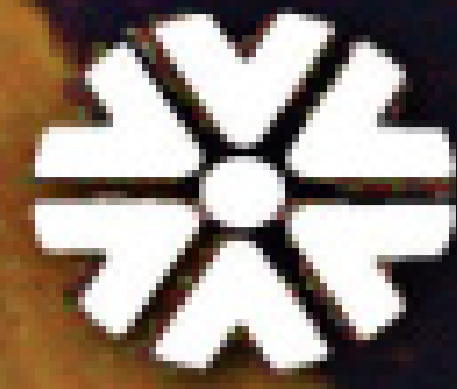

CENTER CAPITAL CORPORATION®

A Webster Bank Company*

Financing geared toward your business success.

THE INTELLIGENT CHOICE

FOR INNOVATIVE FINANCING SOLUTIONS

Environmental Equipment Financing Division

Financing Geared To Your Business Success!

The Intelligent Choice For Innovative Financing Solutions

Center Capital's Environmental Equipment Financing Division offers equipment leasing and financing services tailored to the unique requirements of the waste management and environmental industries. Unlike traditional lenders, our sales team has expertise in both financing and waste management. We understand the kind of payment plans that make sense for your industry. We understand the equipment. We understand the day-to-day business issues you face.

When you work with Center Capital, you're partnering with professionals who understand your business and what it takes to help it grow.

We Cover 50 States!

PAYMENT PROGRAMS

STRUCTURED TO FIT YOUR NEEDS

APPLICATION PROCESS

SIMPLIFIED

VENDOR VALUE-ADDED

PROGRAMS

MORE INFORMATION

CONTACT

**Robert A. Marino
Sr. Vice President**

Phone: 800-344-2224 • Fax: 215-542-1307
Website: www.centercapitalcorp.com

*Center Capital Corporation is a Subsidiary of Webster Bank, N.A., Member FDIC

ENGINE & ACCESSORY, INC.
 Toll-Free: 1.800.327.5431
 Tel: 305.573.2268
 Fx: 305.576.4617
 www.eamfg.com



STOCK UNITS READY FOR DELIVERY



2007 Ford F750 - 2000 gallon tank (1500/500) - Low work station - Masport pump system - Wash down system

Only two units left in stock

Several 2007 Pre-emission Fords and Isuzus available for Portable Restroom Service Units.



2007 Isuzu NQR - 1250 gallon tank (900/350) - Low workstation - Masport pump system - Wash down system.

Only two units left in stock



2008 Peterbilt 340 - Cummins engine - Allison automatic - 4400 gallon tank (4200/200) - 36" rear manway - Wittig RFW200 (730 cfm) pump system with separate cooler - 10GPM @ 2500 PSI Jetter system.

Ready for deliveries

Engine & Accessory is your one stop shop for all of your vacuum truck needs. Delivering the best possible customer experience.

Benefits include:

- **ISP Program - In stock tank and truck program**
- **Direct access to all major chassis manufacturers**
- **State of the art manufacturing facility complete with service shop**
- **Extensive parts inventory and complete product support**
- **Full engineering capabilities using the latest technology**
- **Knowledgeable sales staff**
- **Customizable units with a broad range of options**
- **Nationwide product delivery**
- **Complete package of financing and lease options**

Septic-Scrub™

Used by More Professional Pumpers to Increase Their Business

Backed By Science ■ Proven with Experience ■ Many Satisfied Homeowners

Septic-Scrub™ is a superior product for the maintenance and restoration of septic system drainfields. Customers appreciate that it is environmentally safe, contains no organic chemicals and does not produce any toxic by-products. Most importantly, **Septic-Scrub works.** It breaks down sulfide buildup in the biomat and soil to allow for better water absorption.

Learn more about Septic-Scrub at www.arcana.com.

arcana

P.O. Box 31057
 Clarksville, TN 37040

For information on increasing sales and providing a valuable service to your customers, call Arcan Enterprises at **888-35ARCAN (352-7226)**

Clearly, A Good Idea!



NO CONCEPTS

Solar Powered, Self-Contained, Special Event Restrooms

www.nuconcepts.com

800-334-1065



WE DELIVER MORE THAN JUST A SHINY NEW TRUCK...



We already offer you the most offloading solutions in the industry, and can custom build our vacuum loaders to suit your exact needs. We can help you find financing. And, with our Right Start program, we personally deliver the keys, provide operator and safety training and give you all the information you need to be more productive from the very beginning.

Beyond that we support your new or hard-used old trucks with fast access to genuine Guzzler parts and a toll-free number you can call for application expertise. We also have regional FS Solution service centers that can provide anything from minor repairs and refurbishing to total rebuilds.

And because we want your business to shine as much as a new truck we will pass along customer referrals every chance we get.

For a demo of a shiny new truck*, go to www.guzzler.com today, or call 1-800-627-3171

*Some qualifications apply.

©2008 Federal Signal Corporation. Listed on the NYSE by the symbol FSS.



800.334.8237
www.keithhuber.com

We design the tools to make
your job short and sweet!

Princess



Efficient, high performance,
and durable units manufactured
by Keith Huber, Inc.



Give us a call at 1-800-334-8237.
If you need a portable restroom
service vehicle we should talk!

SmithCo
SIDE-DUMP TRAILERS

SIDE DUMP

Call 800-779-8099
www.sidedump.com

30902 C38
Le Mars, Iowa 51031

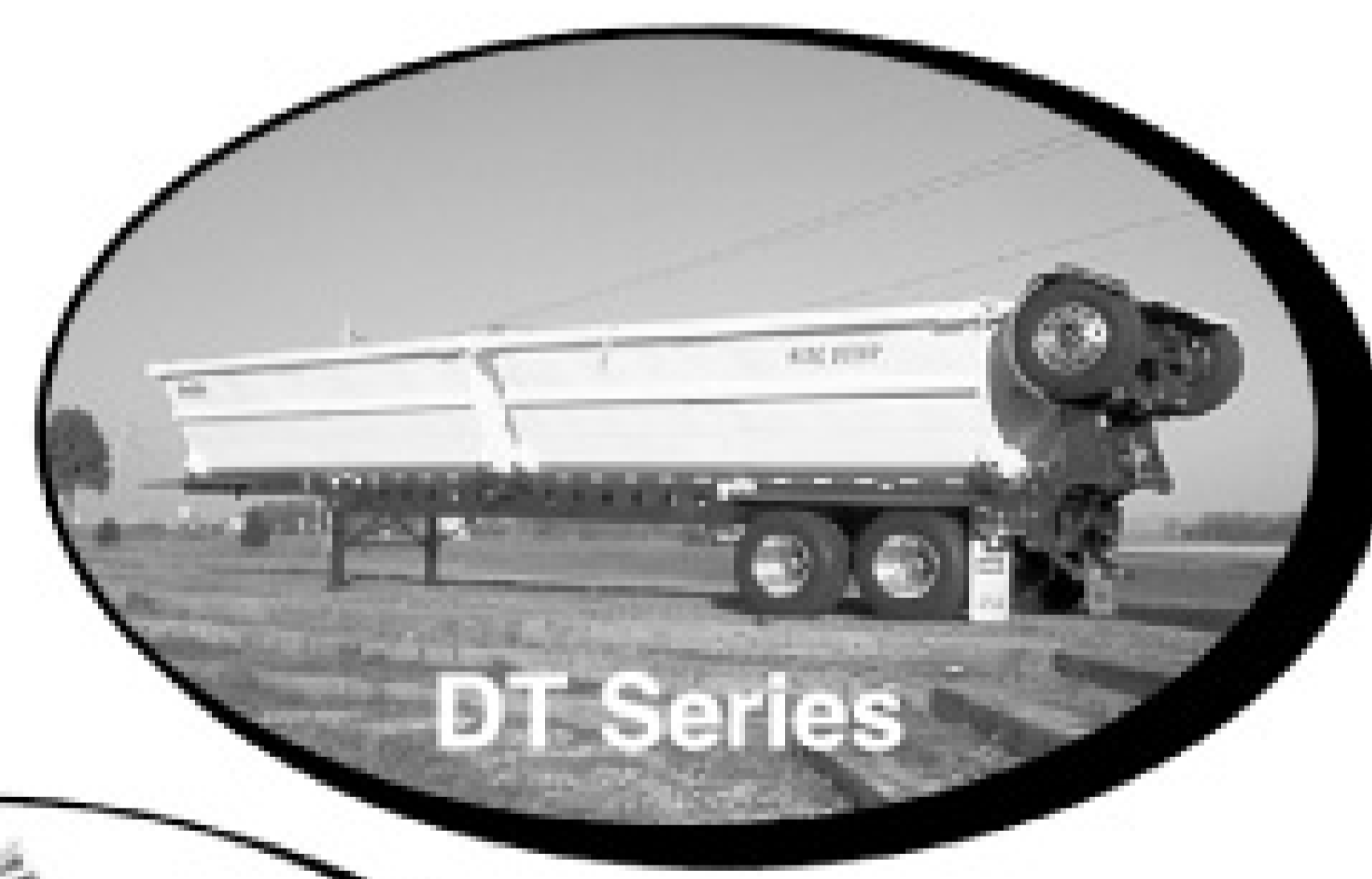

Manure, Slurry, Sludge, Green Waste, Food Residuals, Compost, SmithCo Hauls it All.
Stock Pile, Spread, Stability, Selection, Service...SmithCo

**ARMAL IS READY TO HELP YOUR BUSINESS
GET THROUGH THESE TOUGH TIMES BY
OFFERING YOU A FANTASTIC 50% OFF DISCOUNT**



LEDVES

REGULAR PRICE

~~**\$ 599.00**~~
ea.

DISCOUNT PRICE

\$ 299.00
ea.

when you buy 104 TOP LINE portable toilets

FREE DELIVERY

continental US only

LIMITED TIME OFFER

Ask us about our portable toilet accessories. Hand wash units, chemicals, trailers.....

Top Line.

The new portable toilet:

more durable, easier to handle and easier to clean.

With TOP LINE you get a high quality toilet
at an unbeatable price and free delivery.

Walls do not have Armal logo.

Armal

www.armal.biz

Armal Inc. 122 Hudson Industrial Drive, Griffin, GA 30224 - USA

Phone 770 491 6410 - Fax 770 491 9458 - Toll Free 866 873 7796

armal-inc@armal.biz

THE "BEAST" IS UNLEASHED..

2 HP GRINDERS

CHOP IT...GRIND IT...SPIT IT OUT!



THE BEAST
LINE OF 2 HP GRINDERS!

Flows up to 40 GPM @ 20'

Unique 115 Volt Model, Single and Double Seal
Perfect for Voltage Restrictions

Patented Dual Impeller Grinder

Performs up to 245 feet of lift

Over 830,000 Cuts Per Minute

Complete Job-Ready Package Systems Available!

Call Today for Crossover and Quote!

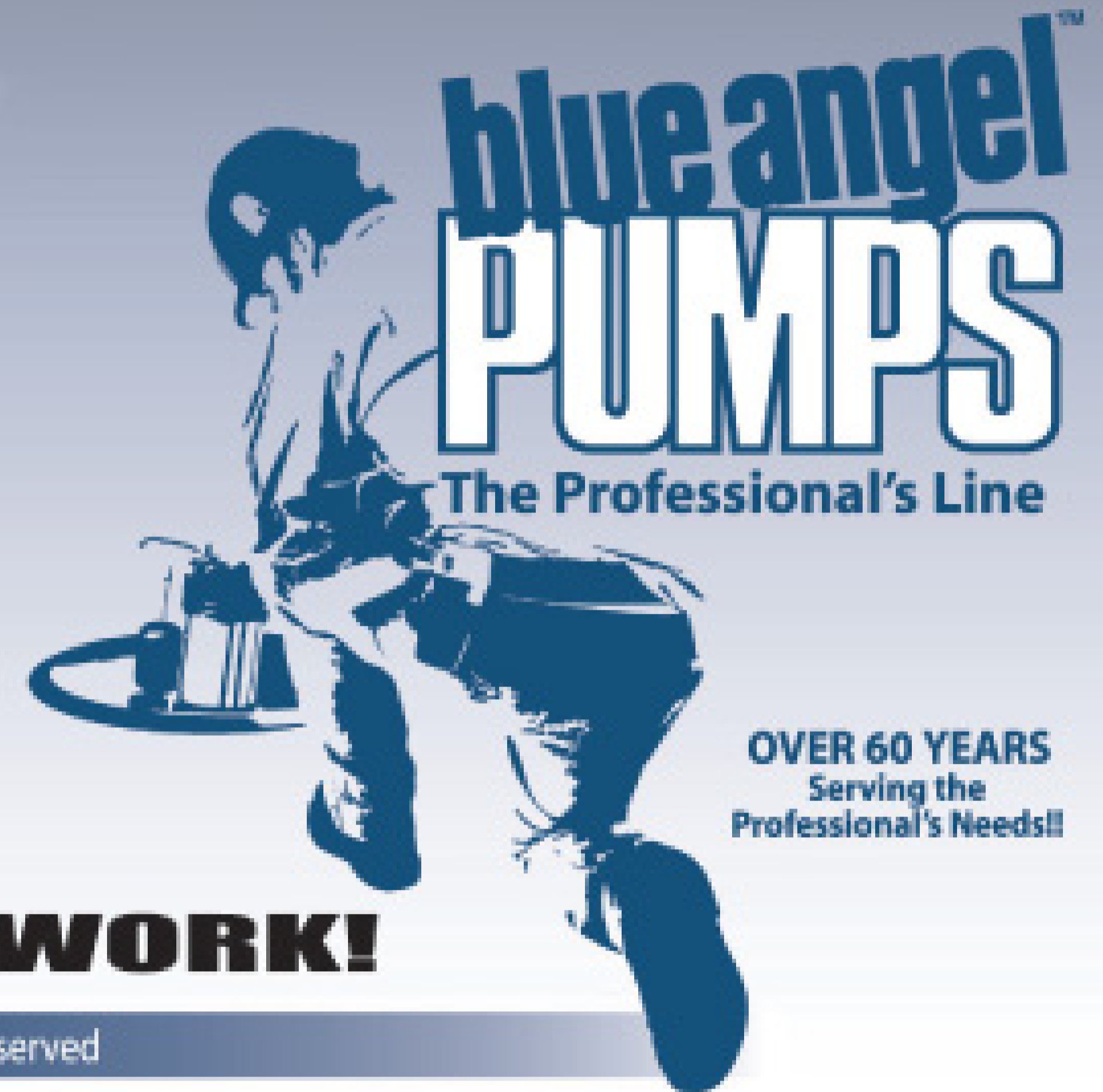

blue angel
PUMPS

The Professional's Line

OVER 60 YEARS
Serving the
Professional's Needs!!

ELIMINATE YOUR DIRTY WORK!

101 Production Drive, Harrison, OH 45030 • 888-636-6628 • www.blueangelpumps.com • © 2008 Blue Angel Pumps All Rights Reserved



Now In **STOCK!** On-The-Lot Selection
Call For Prices & Pre-Approval!



Trade In

Used 2006 Sterling with 2500 gallon steel tank, available in June low miles, manual trans Cat engine Jurop pump.

Call for price and details.



2007 Sterling AUTO TRANS 2500/300 Gallon Aluminum, PM80 pump Cat 275HP, Allison Auto, Exhaust brake, Traction Control.

\$92,000



2007 Sterling 2500 gallon Steel Jurop pump, Mercedes 260 HP, 10 spd, engine brake, Traction control ALUMINUM HOSE TRAYS.

\$79,000



2001 F750
2500 gallon,
Great buy!

Call for price

DIESEL FUEL PRICES TOO HIGH?

Buy a **New 2007 Single Axle Pumper** from Badger in **June** & Badger **pays** you for the first **500 GALLONS***

* Certain restrictions apply. Call for details

We Have Financing Available!

Call Us Today Toll-Free:
888-201-9166

Septic - Portable Toilet - Hoisted Vacuum - Slide-Ins
New! Units Available / Trade-ins Accepted! / Financing & Lease Plans



ABERNETHY

WELDING & REPAIR INC.

Vale, North Carolina 28168

Call Bill Abernethy at **1.800.545.0324**

Fax: 828.324.2401 • E-mail: abernethyinc@charterinternet.com

authorized distributor for:



www.abernethywelding.com

**2008's
Are Here!**

- International
- Ford • GM

2008 PETERBILT

2500 gal. tank, 10-spd., 330 hp

2008 KENWORTH T300

2500 gal. tank, 6-spd., 260 hp

(2) 2008 INTERNATIONAL 4400

2500 gal. tank, (1) 6-spd. transmission & (1) auto transmission

NEW PORTABLE TOILET UNITS:

2008 FORD F750

1500 gal. portable toilet service units, auto transmission

2008 HINO

1500 gal. portable toilet service units, auto transmission

(2) 2008 INTERNATIONAL 4300s

1500 gal. portable toilet service units, auto transmission

2008 5500 CHEVROLET

1000 gal. 700 waste / 300 fresh, 2 Wheel Drive & 4 Wheel Drive available

2008 KENWORTH

1500 gal. portable toilet service unit, auto transmission

2008 PETERBILT

1500 gal. portable toilet service unit, auto transmission

WE WILL CUSTOM BUILD YOUR TANK UP TO 5000 GALLONS!

600-1500 Gallon Portable Toilet Trucks: Our Truck or Yours

SEVERAL GOOD, OLDER TRUCKS TO CHOOSE FROM:

- 1999 International 2500 gal. dump tank
- 1998 Volvo - 4000 gal. tank
- 1997 Volvo - 4000 gal. tank
- 1997 Ford - 2500 gal. tank
- 1995 Chevrolet 2500 gal. dump tank
- (2)-1995 International 2500 gal. tank
- 1992 GMC - 2500 gal. tank
- 1991 Chevrolet 2000 gal. tank, low miles, low hours

PORTABLE TOILET UNITS:

- 2002 International 1500 gal. aluminum tank
- 1999 Freightliner - 1500 gal.
- 1999 Sterling - 1500 gal.
- 1997 Ford F450 - 800 gal. tank
- 1994 UD - 1200 gal. tank
- 1991 4700 International 1400 gal. tank

**MANY OTHER
UNITS IN STOCK!
CALL FOR UPDATE**



2008 International 4400E Series, 260 hp diesel DT 466 engine, 6-spd. trans. and world class auto, air brakes, 33,000 GVW, air conditioned, 2500 gal. tank, Masport HXL400 pump. **IMMEDIATE DELIVERY!** Also, 2500 and 3500 gal. tanks **READY FOR IMMEDIATE DELIVERY.**



2008 International 4300, 220 hp DT466, Allison auto. trans., air brakes, 25,999 GVW, air conditioned, total tank capacity: 1100 waste/400 fresh, Masport HXL75V pump. **IMMEDIATE DELIVERY!** Also, 1500 gal. tanks **READY FOR IMMEDIATE DELIVERY.**

Check with us on financing for the purchase of a new truck!

COMPLETE PARTS AND IN-HOUSE SERVICE FOR:

AIC Vanes • Moro • Battioni • Jurop • Masport • Fruitland • NVE • Powerflo • Plus many other brands

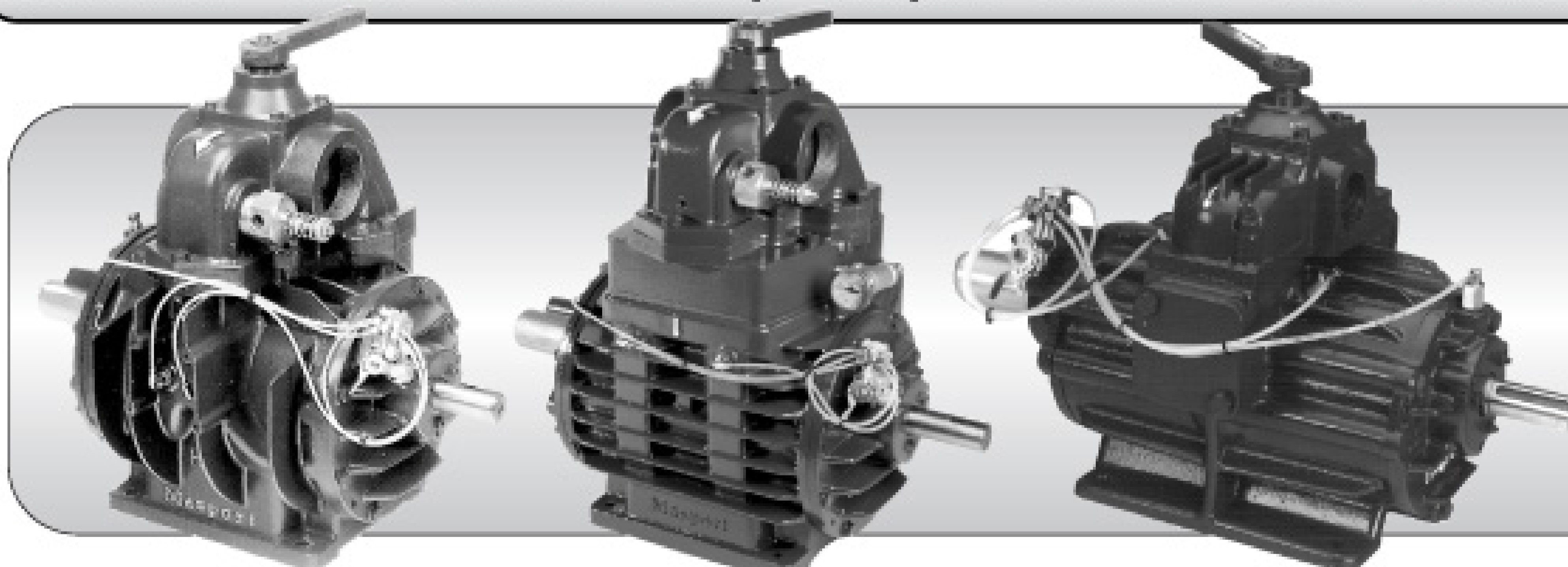

**Complete Line of
Masport Pumps
Available**

Immediate Delivery

OVERNIGHT DELIVERY ON PARTS • SAME DAY SHIPMENT ON PUMPS

WE SPECIALIZE IN PORTABLE SANITATION AND SEPTIC PUMPING EQUIPMENT

Lengthwise

When you anticipate higher sewage flows, go long, not wide, with the mound system seepage bed design

By Roger E. Machmeier, Ph.D.

Q I see that you don't like the width of the rock layer in a mound to be more than 10 feet. What's the reason for that? I see lots of beds that are a lot wider than 10 feet. Why can't a rock layer in a mound be more than 10 feet, when beds are a lot wider than that?

A Let me first explain how a sewage treatment mound works. The purpose of the mound is to provide treatment for sewage tank effluent where there is shallow soil depth over a restricting layer. The topsoil layer may be only a couple of feet thick above the saturated soil layer below. The soil is saturated when there is a discoloration called mottling.

The reason that the soil is mottled is that liquid moves through it very slowly. At times during the year, the soil layer is totally saturated. The saturated layer turns anaerobic, dissolves iron and becomes gray. When the soil dries out, some of the iron oxidizes and turns brown. The soil color is gray with brown spots or streaks. This is called mottling.

The saturated layer of soil may let water move through it at a rate of a half-inch per day or even less. The amount of effluent applied to the rock layer of the mound is 1.2 gallons per day per square foot. This is equivalent to a liquid application of almost two inches every day.

The liquid moving down

through the rock layer and the clean sand layer of the mound must spread out over the saturated layer. There must be at least four times the amount of underlying soil as the width of the rock layer of the mound. This additional area allows the liquid to spread out and percolate downward through the underlying soil.

So the clean sand layer spread over the soil must be at least 40 feet wide for a 10-foot-wide rock layer in a mound. This is another 30 feet of width beyond the rock layer. For higher sewage flows, the length of the mound must be increased and not the width.

As an example, suppose that the rock layer of the mound was 20 feet wide. The clean sand layer would need to extend at least another 60 feet. This would be 80 feet of width, plus the dikes on each side. And the height of the rock layer would need to be increased to allow the liquid to move sideways away from the rock layer.

I hope this explanation gives you a better idea of why the rock layer width in a sewage treatment mound should be no wider than 10 feet.

I would like to comment on your statement that "beds are a lot wider than that." It is true some very wide beds are being designed and installed. In my opinion, the very large beds now being designed and installed may have problems to continue to accept sewage tank effluent at the design rate. There also may be problems of adequate pathogen removal and concen-

The clean sand layer spread over the soil must be at least 40 feet wide for a 10-foot-wide rock layer in a mound. This is another 30 feet of width beyond the rock layer. For higher sewage flows, the length of the mound must be increased and not the width.

tration of nitrates in the groundwater. There are more factors to consider than just "getting rid" of the sewage tank effluent.

One problem will be groundwater mounding under the wide bed. If the underlying soil will not continue to accept a flow of 2.0 inches per day, a water table will rise under the bed. As this water table "mounds up" it will slow down the flow from the wide bed.

Another problem will be the lack of soil oxygen under the center of the bed. The oxygen must come in from the side of the bed.

In a wide bed, the distance is too great for adequate oxygen movement. Oxygen is necessary to prevent anaerobic conditions in the soil under the bed. When the soil under the bed becomes anaerobic, the biomat gets thicker and the flow through it slows down. This is why individual seepage beds should not be wider than 10 feet.

Many years ago at Westboro, Wis., the lack of oxygen in the soil under 100-foot-wide beds slowed the design acceptance rate of 2.0 inches per day to a rate of 0.55 inches. This reduced acceptance rate resulted in the hydraulic failure of the beds.

Another problem is an adequate evaluation of the soils

under the wide bed. Soil texture is often quite variable from place to place in an area. It would be unlikely that the soil texture would be exactly the same over the bottom of a wide bed. If the original area was not level, the excavation depth will vary and different layers of original soil will be exposed.

The percolation rate may be measured by the standard test using a 6- or 8-inch diameter hole. This test measures the horizontal permeability of the soil in the location of the test. For a very wide bed, the vertical permeability of the various soil layers under the bed is the information needed for design purposes.

Finally, construction practices must not allow any heavy equipment into the bottom of the wide bed. It may be difficult or not possible to follow this important rule on very wide beds. I have been told that there have been hydraulic failures of large beds recently installed. The design criteria used for individual onsite sewage treatment systems simply do not apply to large and wide seepage beds. Unless the designers recognize this, there will be more failures of wide beds. ■

Readers are welcome to submit questions to the Answer Man. Send your question to COLE Publishing by e-mail to editor@pumper.com, by fax to 715/546-3786; or by mail to P.O. Box 220, Three Lakes, WI 54562. We will pass your question along to Dr. Machmeier.



T **RANSWAY** *SYSTEMS INC.* **PROFESSIONAL VACUUM EQUIPMENT**

Toll-Free: 800-263-4508

DELIVERY SERVICE
AVAILABLE

T: 905-578-1000

F: 905-561-9176

314 Lake Ave. North
Hamilton, Ontario L8E 3A2

WE PAY BORDER CROSSING CHARGES • LEASING? WE CAN REFER YOU TO THE SPECIALISTS • OVER 40 YEARS IN BUSINESS

HEAVY-DUTY EQUIPMENT THAT WORKS!

**LET 45 YEARS
OF EXPERIENCE
WORK FOR YOU !**



POWERFLO

1-800-758-4788

Vacuum Pumps & Tank Parts at WHOLESALE PRICES!

Juop

PRODUCTS INC.



PN84
• 252 cfm @ 18"
• Air Cooled
PN 23, 33, 58, 84, 106
IN STOCK.



LC420
• 425 cfm @ 18"
• Liquid Cooled



R260
• 304 cfm @ 18"
• Ballast Port Cooling

\$2,590



Performer Series PF540

POWERFLO MODEL:	PF530	PF540
Air capacity displacement	250 cfm	290 cfm
Air capacity displacement @ 15" Hg	240 cfm	310 cfm
Maximum vacuum	95%	95%
Maximum pressure	30 psi	30 psi
RPM	1200	1200
Weight	300 lbs	357 lbs



Piston Action Gate Valve
Brass
4" - \$69
6" - \$183

RT Anale Gearbox
1" - \$199
1 1/4" - \$299



Lever Action Gate Valve
Brass
3" - \$98
4" - \$157
6" - \$288

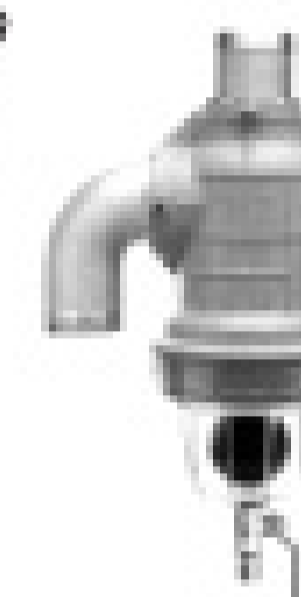

Secondary
Nylon/Brass
2" - \$160
3" - \$206

PUMP VANES

BULLET-PROOF your pump with KEVLAR BLADES

DURA FLO BLADES



DC-10
Heavy-Duty Washdown Pump

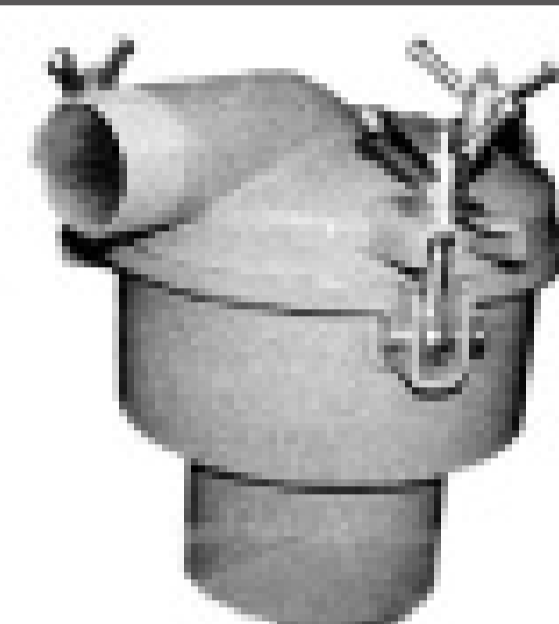

Low Pro Primary
\$295

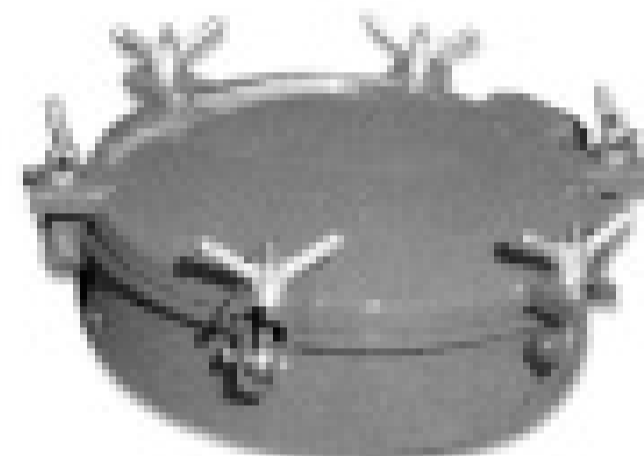

Manway Special Gasket in lid
17"
20"



POWERFLO PRODUCTS INC. • 2755 N. Gaviota Ave. • Signal Hill, CA 90806 • Phone: 562-997-0720 • Fax: 562-997-0724

THANKS, JERRY'S SERVICES

STAINLESS STEEL & STEEL UNITS CALL FOR INFORMATION

THANKS, WILLIAMSON PUMPING

PUMP DISTRIBUTOR

- * BATTIONI
- * JUOP
- * BOWIE
- * MASPORT
- * FRUITLAND
- * MORO

Pump Rebuild Kits In Stock

CALL TODAY FOR INFORMATION OR PRICES ON TANKS, PUMPS AND ALL PARTS

Secondary Shutoffs

Sight Glasses, Valves & Couplings



12" Primary Shutoffs



21" & 36" Manways



BASE TANKS INCLUDE:

1/4" Thick Steel • Pipe Reinforced Baffles • Primary Shutoff Flanged and Dished Heads • 21" Top and Rear Hatches Full Length Under Carriage on Bottom of Tank

BASE TANK PRICING

2100 GALLON.....\$6150	3360 GALLON.....\$8910
2500 GALLON.....\$7080	3570 GALLON.....\$9470
3000 GALLON.....\$7820	4000 GALLON.....\$10,520



800.364.7307

2100 EAST BOOTH ST. • SEARCY, AR 72143
Fax: 501.279.0003 • E-mail: sbs@cdlworld.net

Vacuum Septic, Restroom Service Tank Trucks & Trailers Code & Non Code Applications



2008 Sterling 9500 Series

410/450 Mercedes diesel, 10 speed 18,000 front – 40,000 rear (air ride)

Very heavy duty specs – loaded!

New 4200 Gallon Aluminum Septic

Masport HXL400 water cooled pump

All standard features – tool boxes.

\$125,500 Plus F.E.T.

F.O.B. Kansas City

Monthly Lease From...\$2,500



Refurbished! 2001 Freightliner FLD112

ISM 330 H.P. Cummins – 9 speed,

200,000 Mile Power Train Warranty

New 3600 Gallon Aluminum Septic Tank

Masport HXL400 water cooled pump

All standard features – large tool box

\$82,000 Plus FET (tank only)

Monthly Lease From...\$1619

F.O.B. Kansas City

Looks & Operates Like New!



2008 Sterling Bullet

Cummins 6.7 liter turbo diesel-305 HP,

limited slip rear, 6 speed manual, 7000 lb front /

13,500 lb. Rear Axle, Exhaust Brake, AM/FM-CD, Cruise...more!

1250 Gallon Tank (2) Compartment

Masport HXL4, dual service, Burks DC 10 wash down system,

Hot shift PTO, tow package and toilet carrier.

\$66,950 F.O.B. Kansas City

As Low As... \$1339 mo.



7000 Gallon Trailer

5454 Aluminum- 3/8" heads, Full length hose trays,

(2) ladders, rear bumper, 6" discharge 4" inlet,

Hendrickson air ride suspension, (2) 25,000 lb.rear axles

\$54,000 Plus FET

F.O.B.,Arthur, IL

Monthly Lease From...\$1,080 mo.



1-800-971-7657

www.tstllc.com

email us from our website

featuring





wallenstein vacuum pumps

**The most rugged, dependable
longest lasting vacuum pumps
in the industry!**

**New
Product**

800 CFM

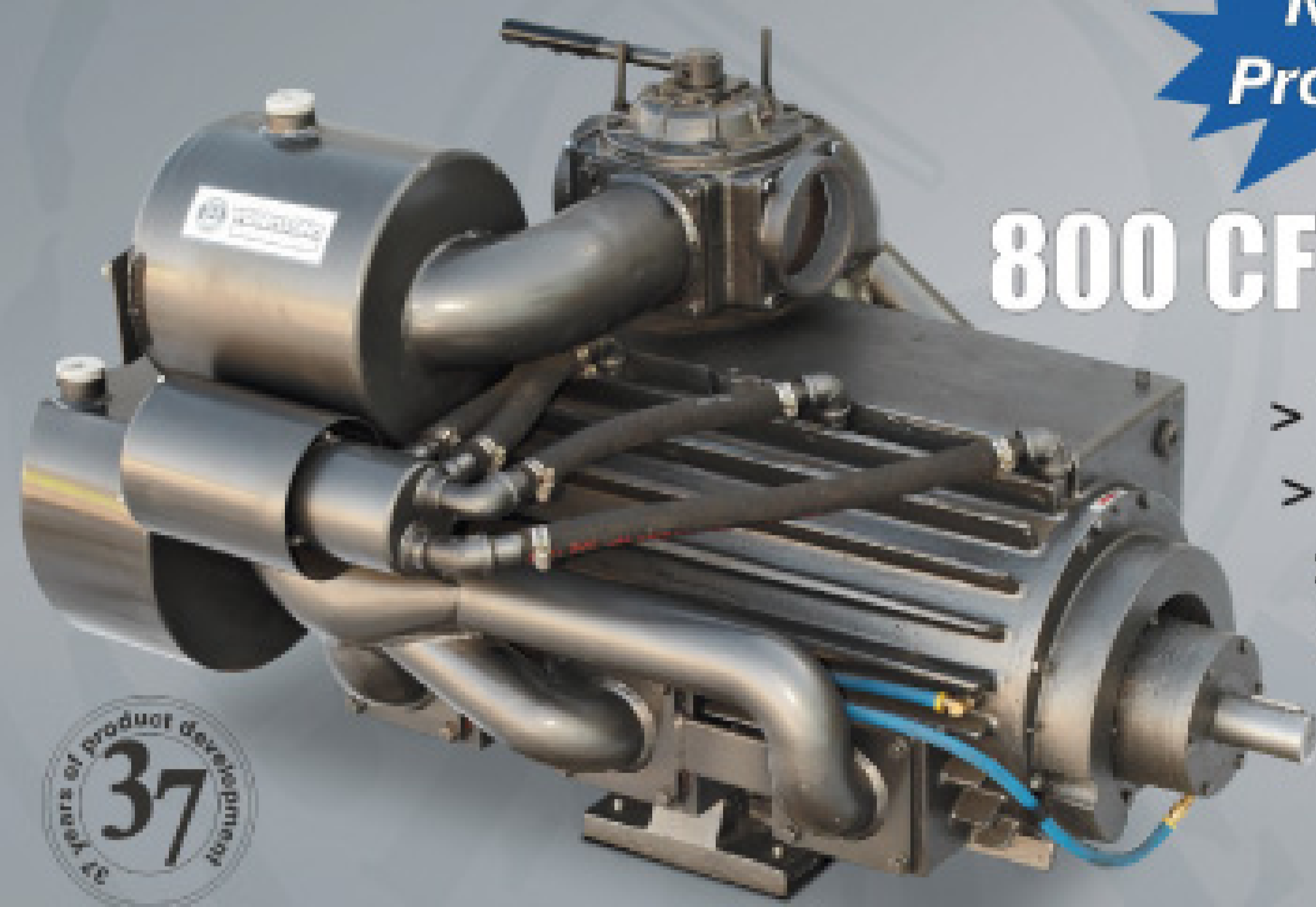

- > Rugged design
- > Quality construction
- > Wide fiber vanes
- > Easy internal access
- > Low noise level
- > Two year warranty

Components

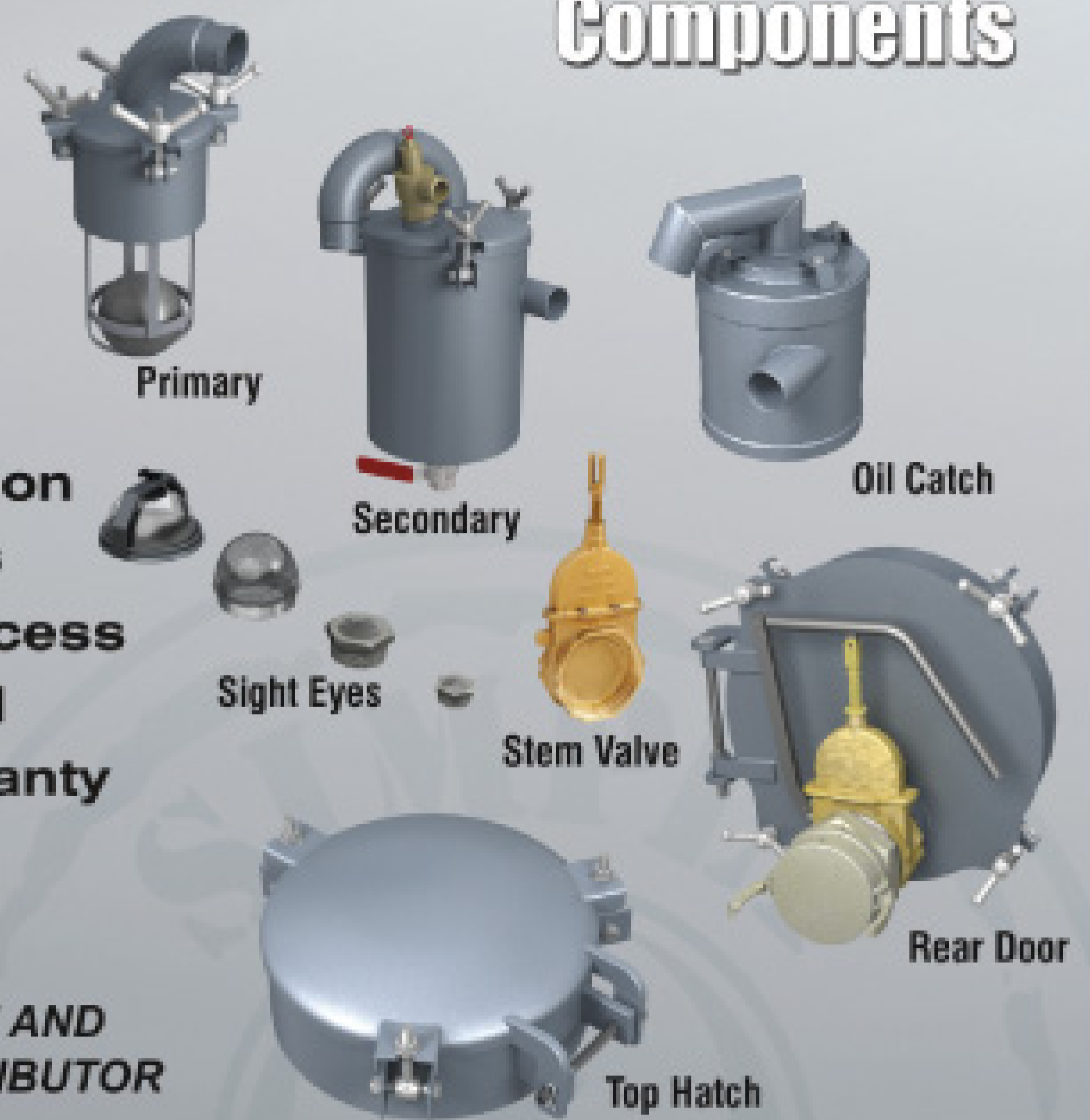

Series	Rating CFM	Vacuum *HG	HP (Vacuum)
1600	800 cfm @ 15 hg	28	55

CALL FOR PRODUCT LITERATURE AND
YOUR NEAREST AUTHORIZED DISTRIBUTOR

Toll Free 1-800-801-6663 fax 519-669-8331 email info@wallensteinpumps.com

MEGA Holding Tank

1250 Gallon Size



Options

Black Color • Level Alarm • Custom Fittings

LOW PROFILE Portable Holding Tank

100 • 210 • 300
Gallon Sizes

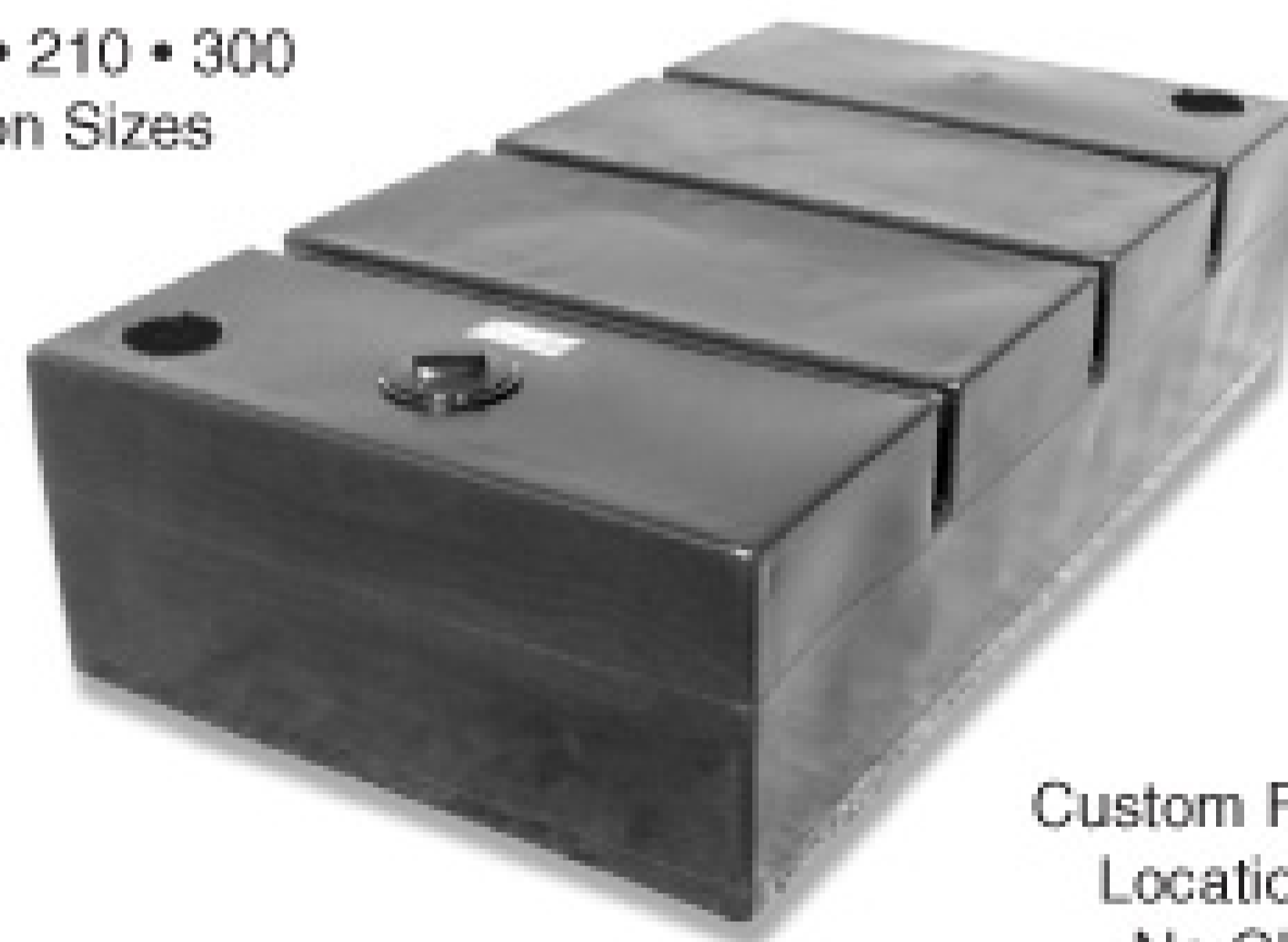

Custom Fitting
Locations at
No Charge

On-Site Water System

OSW PLUS —

- Tough 65 gal. Tank
- Removable cover for easy cleaning
- 115V On-Demand Pump 3.5 gpm 45 psi
- Low water shut-off
- GFCI Protected
- Filter
- Ships UPS

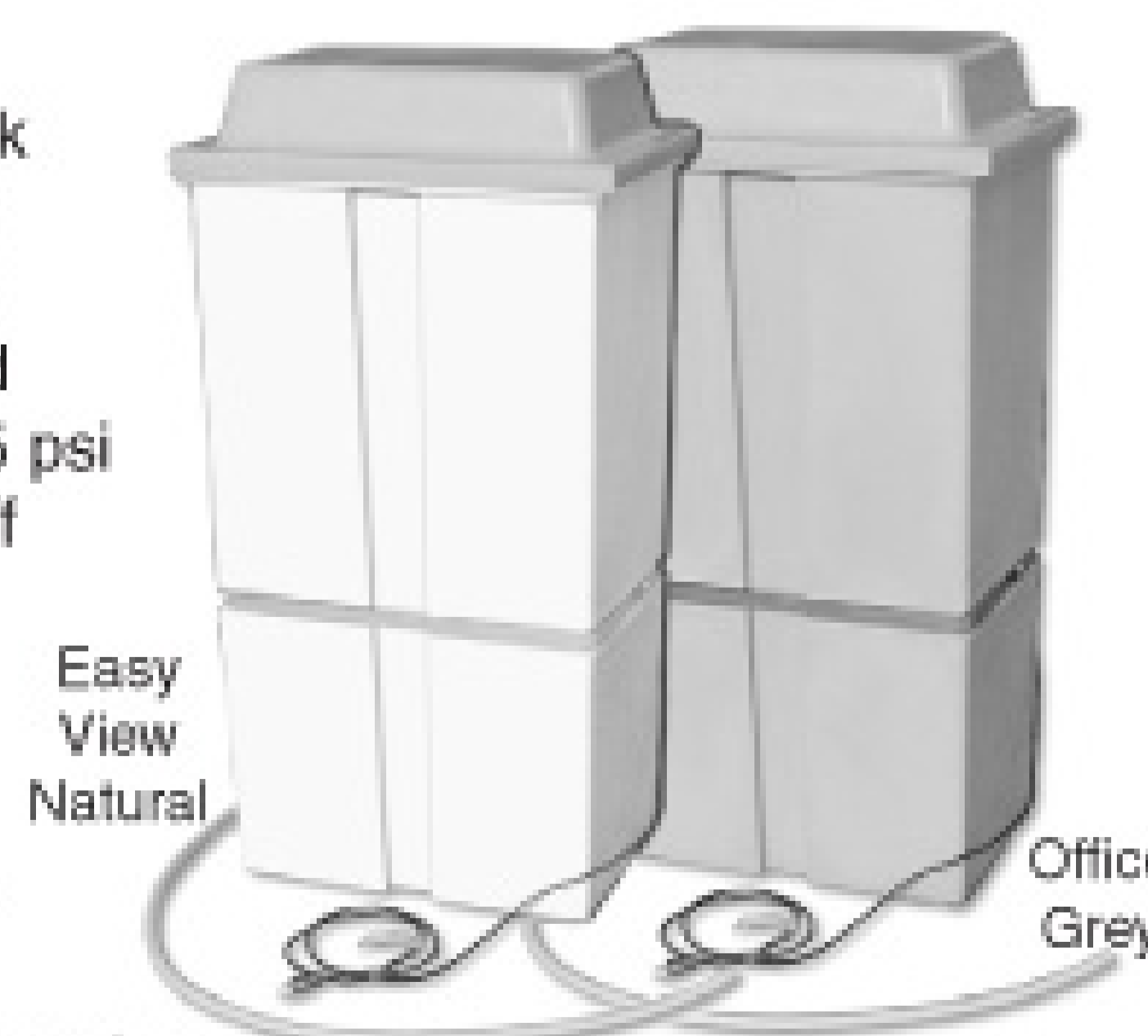

OSW DELUXE —

- Add external fill connection w/float valve

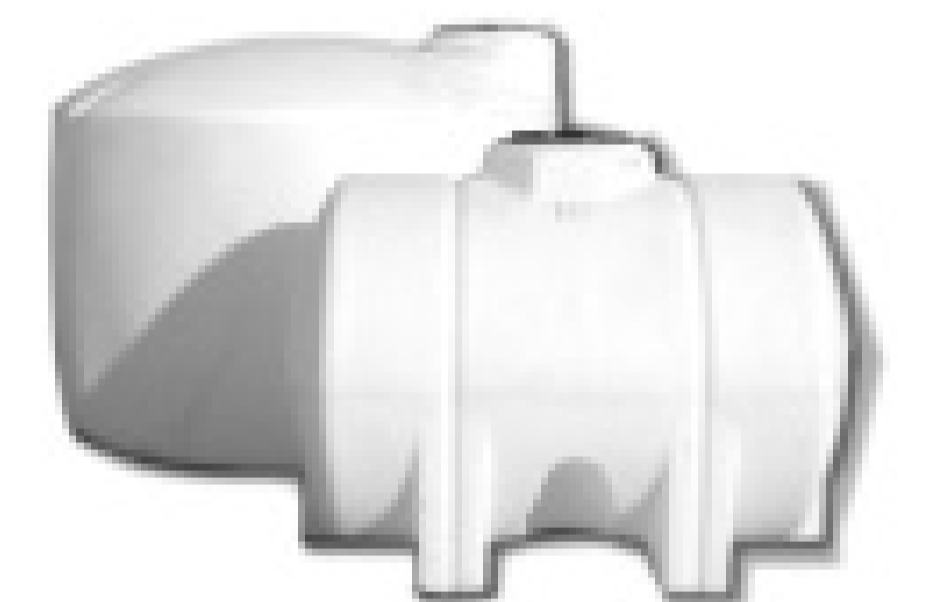

Bulk Storage and Transport Tanks



Septic and Cistern Tanks



Ball Valves and
Cam Lock Couplers

NORWESCO

Distributor Since 1987

Nationwide Shipping Points



KentuckyTank
Plastic Tanks and Accessories

1-888-459-8265

www.kentuckytank.com

**SUMMER-TIME
TOUGH!**
3rd Gear
Turbo Tubes
handle
hot temps
best...

TEAR... SQUEEZE... ODOR'S GONE!

New!

Turbo Tubes make quick work of toilet tank odor.

What could be easier? Or more powerful? The concentrated power of Turbo Tubes handles the toughest odor in seconds. Now available in three strengths for use in all seasons and conditions. New Turbo Tubes make your job easier.

- ✓ **EASY to use:** Simply tear off the top and squeeze into the tank
- ✓ **EASY to deliver:** Moisture Guard package protects against accidental activation
- ✓ **EASY to ship:** Small, lightweight packages mean less freight charges
- ✓ **EASY to control:** Proportioned quantities insure proper use and less waste
- ✓ **EASY to buy:** Turbo Tubes cost less than other portioned-controlled products
- ✓ **EASY to store:** Turbo Tubes have a long shelf life and are simple to inventory
- ✓ **EASY to handle:** No bulky containers to handle, or bottles to fill
- ✓ **SAFE to use:** Turbo Tubes are people-friendly and earth-friendly. No carcinogens.

Green Way Products are always safe - always reliable - in all seasons, all the time.

**FREE
SAMPLE
PACK**

Try them for yourself. See how Turbo Tubes make your job easier. Simply call Cindy (or your area manager) for a free sample pack.

800-241-7951



POLYPORTABLES

Listening. Learning. Delivering. Since 1972

99 Crafton Drive, Dahlonega, GA 30533 USA
Phone (800) 241-7951 or (706) 864-3776 • Fax (706) 864-8111
www.polyportables.com



TOILET DEODORIZERS • TOILET CLEANERS • AIR FRESHENERS • INSECT REPELLANT

All Green Way deodorizers, cleaners and air fresheners are earth-friendly, people-friendly products. They are developed and manufactured in our facilities in Dahlonega, Georgia by Green Way Products, a PolyPortables sister company.

Patent Pending



NAWT BOARD OF DIRECTORS:

Hollis Warren, President, DE
Tom Frank, Vice President, OH
Bruce Fox, Past President, PA
Mitch Okerstrom, Treasurer, MN
Tom Ferrero, Secretary, PA
Jim Anderson, MN
Mark Hacker, IN

Tim Frank, OH
Bill Hall, CT
Wayne Hudson, DE
Darlene Johnson, NH
Bob Kendall, WI
Frank King, MA

Ralph Macchio, NY
Lee Orton, NE
Richard Sinclair, AZ
Jeff Snowden, TX
Carl Stenberg, MI
Roger Winter, Ontario

NAWT EXECUTIVE DIRECTOR: A. Thomas Ferrero, Jr.

NAWT Waste Treatment Symposium Set For Missouri

By Tom Ferrero

We're getting ready for our third annual Waste Treatment Symposium on Sept. 10-11 at the Holiday Inn at Six Flags in Eureka, Mo., 30 miles west of St. Louis. By all accounts, last year's symposium was a success. The most common comment heard from

THE MOST COMMON COMMENT HEARD FROM VENDORS OR PARTICIPANTS AT THE 2007 SYMPOSIUM WAS, "I GOT FAR MORE OUT OF IT THAN I EVER ANTICIPATED."

vendors or participants was, "I got far more out of it than I ever anticipated." We had 150 attendees, 50

more than in 2006. This year, we're expecting at least 200 registrants. Our instructor list isn't finalized yet, but the agenda will include:

Tuesday, Sept. 9: Vacuum Truck Technician Training

This full-day course is for new owners and employees who operate vacuum trucks to clean septic tanks, aerobic treatment units, holding tanks or grease traps. It can also serve as a refresher course and overview for experienced operators. Training is done through presentations, videos and hands-on exercises with a pump truck. The Pennsylvania Septage Management Association has developed a train-the-trainer program so the course can be presented in your state or company. The \$175 course includes:

- Basic pump truck operation
- Materials to pump and avoid
- Reasons to manage these materials
- Pumps
- Basic science of vacuum and pressurization
- Truck equipment and components
- Drive and control mechanisms
- Basic and advanced pump-out skills and procedures
- Loading and unloading
- Safety and emergency response plans
- Customer interaction and education
- Manifests and reports
- Government regulations

Wednesday, Sept. 10 (classroom): All You Need to Know About Treating Septage and Grease Trap Waste

- Description of the treatment process.
- Hiring an engineer — Which ones are experienced enough to design dewatering plants?
- Resources — How will you dispose of the solids and water? Participants will gain the knowledge to create a business plan based on their unique set of circumstances.
- Case histories — Why people started their own dewatering facilities, the hurdles they overcame, and the outcomes.
- Treatment economics and alternatives.
- Dewatering operations — Screw press, rotary press and container filter.

- Vendors — 15-minute presentations on the benefits of using their products and when to use them.
- Social hour for networking with regulatory people, engineers and vendors. Dinner is on your own.

Thursday, Sept. 11 (field trip)

Attendees will be bused to David Flagg's Septic Services' treatment facility in Union. Vendors will dewater actual septage and grease trap waste, showing how the equipment functions and the process works. They also will demonstrate various peripheral equipment and polymer conditioning, offering tips for maximizing the latter's efficiency. Ample time is scheduled for networking with vendors, participants and industry leaders.

Vendors

The list of vendors is firming up. The following companies have participated in the past:

- Aqua Ben Corp. — polymers
- Atlantic Dewatering — container filter
- FKC Screw Press — screw press
- Fourier Corp. — rotary press
- Big Fish Environmental LLC — turnkey septage treatment facilities
- Center Capital Corp. — financing
- Carmeuse — lime supplier
- Geotube — dewatering tubes
- Burt Waste — oil/water separator
- Labrie Environmental Group (Juggler) — separator truck
- Lely Manufacturing — screening equipment
- Lakeside — screening equipment
- Vogelsang — pumping and shredding equipment

The symposium registration fee of \$225 per person (non-NAWT members \$325) includes full symposium privileges, lunch both days, and transportation to and from the septage treatment facility. Download a registration form at www.nawt.org. Registrations at the door are accepted, but classroom capacity is limited. To guarantee your seat, please phone, fax, or mail your registration with payment by Sept. 1 to NAWT, 336 Chestnut Lane, Ambler, PA 19002-1001; Tel: 800/236-6298; Fax: 267/200-0279. For lodging, call the Holiday Inn at Six Flags at 636/938-6661. Mention that you are with the National Association of Wastewater Transporters Symposium for a discounted rate.

NAWT AT LOUISVILLE

Thanks to all of you who made the NAWT booth a destination while attending the Pumper & Cleaner Environmental Expo International at the Kentucky Exposition Center in Louisville. Each of our educational tracks attracted 300 to 400 people. Once the show officially opened, you kept us hopping answering questions and offering guidance. Providing information isn't something done just at shows. NAWT's office is here to help whenever you have a problem or need information on anything from mechanical to administrative to legislative. Check us out at www.nawt.org. ■

**International 7400 Series
3600 Gallon Septic**



ALUMATANK

**2008 International 7400
56,000 GVW**

- Auto Transmission -

- Masport HXL 400 water cooled
400 CFM pump
- Hot shift PTO
- 20" top man way
- 20" rear cleanout
- Rear sump with 6" discharge
and 6" flange
- Large tool box



IN STOCK! Complete Unit \$114,200
Monthly Lease As Low As... **\$2,284**

Unit #1355: 4200 Gallon Septic Tank
NVE 506 Vacuum System
2008 Peterbilt 340
58,000 G.V.W., 18,000 lb. front axle
10 speed transmission

\$116,928 Lease from **\$1434** mo.
Plus F.E.T.



Unit # 1401: 1250 Gallon Restroom Tank
Masport HXL4, Burks DC10, Hot shift PTO.
Dual service – (2) reels

2008 Sterling – Bullet
19,500 G.V.W – manual transmission

\$66,950 Lease from **\$1339** mo.



1-800-392-3513

www.excel-equipment.com

Tel: 317-882-1300 Fax: 317-889-0052
585 Sayre Court, Greenwood, IN 46143



Unit #1383 1700 Gallon Restroom Tank
Masport HXL4, Burks DC10, Hot shift PTO.
Dual service – (2) reels
2007 International 4200 26,000 GVW
Automatic transmission, Air brakes
\$73,830 Lease from **\$1476** mo.



Unit #1356 1500 Gallon Restroom Tank
Masport HXL4, Burks DC10, Hot shift PTO.
Dual service – (2) reels
2008 International "Cab Forward"
19,000 G.V.W. auto. trans., hydraulic brakes
\$72,730 Lease from **\$1454** mo.



Classy Truck of the Month

Aardvark Waste Services
Hurricane, Utah

Agitation SAVES Aggravation!

**CHOICE OF
2', 4' & 6'
EXTENSIONS**

**Guaranteed
To Mix Up
Septic Tanks &
Grease Traps!**

High speed rotation
busts the crust and removes solids
right off the bottom of the tank into a
total liquid form

Field tested and proven to mix a
residential tank in 5 minutes or less – takes
approx. 15 minutes to agitate a 5000-10,000
gallon grease trap

**Patent
Pending**

**CRUST
BUSTERS™**

E-MAIL pete@crustbusters.com
WEB SITE www.crustbusters.com

1.888.878.2296

ASK ABOUT OUR "BUSTER BRACKETS" FOR TRUCK MOUNTING

**CHECK OUT OUR NEW
INFORMATIONAL DVD
PUMPER.COM/VIDEO.PHP**

Schmitz Brothers L.L.C.
PHONE 763.878.2296
FAX 763.878.2299

Owner Steve Biggs put this heavy-duty rig together late in 2007 to load up car wash pit and residential septic system waste all day long before making a run to the disposal site. He bought the 2003 Peterbilt 385 with a 500-hp Cat C-15 engine and 10-speed Eaton-Fuller transmission from Donaldson Equipment in Phoenix and drove it back to Utah. The dealer removed the sleeper from the over-the-road semi. FRB Welding in Salt Lake City added a 3-foot frame extension kit and built and bolted on the 4,000-gallon steel tank (3,500 gallons waste/500 gallons fresh) after having it painted white. The truck is equipped with a Robuschi RBS-DV65 blower pulling 900 cfm. There are three, 3-inch fill ports around the tank and a 4-inch fill/dump port in the bottom of a 36-inch rear manway. The freshwater tank in the front feeds a remote-controlled 10 gpm/3,000 psi water pump with an anti-freeze system from General Pump. The hose is fitted with quick-disconnect for swapping washdown nozzles or the hand cart hose reel with 200 feet of jetting hose. Lettering and logos were added by Jeff Dastrup Pinstriping. The truck has air-ride driver's seat, Jake Brake, CD stereo and air conditioning.

Show us yours!

Got a truck with real WOW appeal? Show it off to Pumper readers — and to the whole world through www.pumper.com!

Send photos of your truck after it has been lettered with your company name, and please pose the owner(s) with the truck. Any industry-related truck is acceptable. Please limit your submission to one truck only.

Your submission must include your name, company name, mailing address, phone number, and details about the truck, including tank size, cab/chassis information, pump information, the company that built the truck, and any other details you consider important. In particular, tell us what features of the truck help make your work life more efficient and more profitable. E-mail your materials to editor@pumper.com or mail to Editor, Pumper, P.O. Box 220, Three Lakes WI 54562. We look forward to hearing from you!

Supplying your Business for Seasons of Success



- **One-Stop Shopping**
Our wide selection of products makes shopping at several different places for all of your needs a thing of the past.
- **Very Competitive Pricing**
- **Huge Selection**
We carry a wide selection of portable restroom parts and accessories to take care of all your needs. Including toilet parts, pumps, pressure washers, hoses, valves, fittings, tank components, chemicals, dispenser systems, hand sanitizer, deodorizers and odor control products, engines, sink parts, cleaning supplies, and much much more.
- **Two Locations for Faster, More Economical Shipping**
Our warehouses in Utah and Georgia are strategically placed to service every state.
- **Custom Pump Trucks**
If you can imagine it, we can build it. We pride ourselves on our ability to work with our customers and design an efficient and effective pump truck designed around your custom applications.



**CALL TODAY for your
FREE product catalog!**



1-888-935-1133
www.toico.com

YOUR ONE STOP SOURCE FOR PORTABLE RESTROOM PARTS AND SUPPLIES



Sludge Mate
& Poly-Mate

The Flo Trend® Sludge Mate® and Poly-Mate® form an economical and simple to use sludge dewatering system. The Poly-Mate® conditions sludge through the addition of polymer prior to the dewatering process which occurs in the Sludge Mate®. These units are designed to dewater sludge from a multitude of waste stream sources including: water and wastewater treatment plants, septic tanks, car washes, industrial sumps and lagoons, grease traps, rendering plants, and food processing plants. The Sludge Mate® and Poly-Mate® are available in a variety of sizes and configurations, and are built to custom specifications.



DEWATERING MADE SIMPLE.

Flo Trend Systems Tel - 713-699-0152
707 Lehman St. 800-762-9893
Houston, TX 77018 Fax - 713-699-8054
sales@fлотrend.com



DENVER TRUCK SALES

Nobody Beats Our Quality!



1996-2001 Western Stars

435 Cats, Jake, 18 speeds 46,000 LB rears on Hendrickson air suspension. New 3360 gallon tank, HXL-400 Masport pump, serviced and checked.

From \$64,950 plus F.E.T. on the tank



1996 IHC 9400

14,000 LB f/a 3406 Cat, Jake, 15 speed transmission, 46,000 LB rears hendrickson air suspension. New 3360 gallon tank HXL-400 pump serviced and checked from

\$62,950 plus F.E.T. On the tank

Complete Line of Pumps and Parts



1997 KW T-800 Series

60 Detroit, Jake, RTLO-16713 transmission, RT46160 46,000 LB 4.33 ratio, New 3360 gallon tank, Masport HXL-400 pump, New paint serviced and checked.

\$66,950 plus F.E.T. on the tank



2001 Freightliners FL 120

C15-475 Cat, Jake, RTLO-18918 trans, RT46160 on Hendrickson spring suspension, 4-way locks. New 3360 gallon tank HXL-400 pump

\$79,950 plus F.E.T. on the tank

Easy Financing and Lease-To-Own WAC!

Denver Truck Sales • 5293 Vasquez Blvd. • Denver, CO 80216
Phone: 303-291-0960 • Fax: 303-291-0244 • www.denvertruck.com

Seal it Tight! Seal it Easy! Seal it Fast!

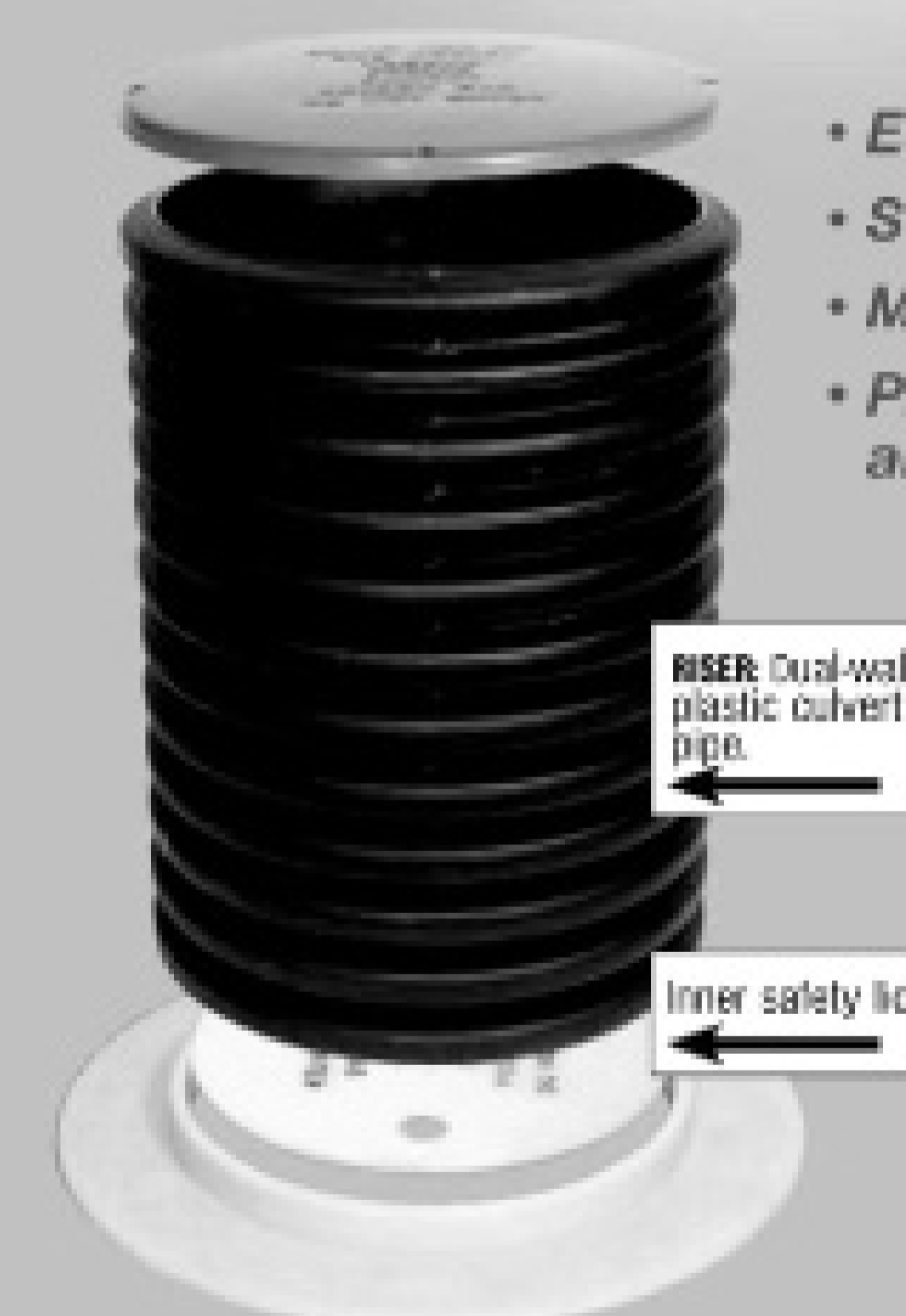

- Easy 10 minute installation!
- Secure fit for all systems!
- Made & sold by septic installers!
- Prevent ground water infiltration and save money at the same time!



Apply foam around to tank.



Place ring over opening and apply foam.



Place plastic riser pipe over ring.



Install lid.

Are you tired of using risers that are too tall or too short for the job you are completing? Plastic riser pipe will give an exact height each time. Try our system and you will never have to carry concrete pipe and lids again. Save time by not having to assemble multiple sections.

Seal-R® Lids Available in 12", 15", 18", 24", 30", 36".
Seal-R® Rings Available in 18", 24", 30".
Inner Safety Lids Available in 18", 24".

Seal-R® Lids can be personalized. Seal-R® Lids are constructed with UV additive to resist degradation from exposure to sunlight.

For more information, call us today!

BrenLin Company, Inc
Manufacturers of Seal-R® Products
Herman, MN
888-606-1998
Fax: 320-677-3001 • Email: brenlin@brenlinet.net

www.seal-r.com

7000 Gallon Aluminum



Manufacturing

- *Stainless Steel*
- *Aluminum*
- *Code & Non-Code*

800-589-5254

ACRO
Trailer Company

Vacuum Trailers for the
Liquid Transportation Industry
Parts • Repair • Complete Pumping Systems

www.acrotrailer.com • 417.862.1758 • fax 417.862.8084 • 2320 North Packer Road • Springfield, Missouri 65803

CUSTOM SIGNS AND DECALS

United
SITE SERVICES
877-340-0004
800-638-1233

(800) 448-4669
A-Throne
Lawn Care & Maintenance

Another...
**ANDY GUMP
FENCE**
1-888-263-9486

Diamond
environmental services
1-888-744-7191

**TROJAN
PORTABLE
SERVICES**
1-800-427-3673

HAULAWAY
STORAGE CONTAINERS
800-222-3337
haulaway.com

All Of Our Custom Manufactured Products
Are Quality Engineered For Long Term
Outdoor Durability.

- Very Competitive Pricing
- Knowledgeable, Helpful And Courteous
Customer Service Staff.
- Dependable Delivery.
- Digital Print And Vinyl Cut Lettering
- Generic Signs And Decals

And Much More!

DURABLE, AFFORDABLE AND BUILT TO LAST
SINCE 1949

J.C. Gury Company Inc.

530 East Jamie Ave, La Habra, CA 90631 Call (800) 903-3385 or (800) 556-5576
www.jcgury.com

FINANCING

FOR ALL YOUR
NEW & USED EQUIPMENT

GIVE US A CALL TODAY!
866-769-2345

**31 YEARS OF EXPERIENCE
WORKING FOR YOU!**



CAPITAL PARTNERS

101 N. Main Ave. Suite 215
Sioux Falls, SD 57104
www.yourcapitalpartner.com
866-769-2345

**YOUR ONE STOP
FINANCING PARTNER**

Competitive Pricing, Simple Processing,
Honest Answers

- Application Only to \$250,000.00
- Simple Approval Process
- Lease or Loan Options
- Aggressive on Used Equipment
- Start-up Programs
- Flexible Financing Available

PORTABLE TOILET
SERVICE UNITS
SLIDE IN UNITS
HOISTED UNITS
ROLL OFF UNITS
CUSTOM UNITS

www.pikrite.com



pikrite

Manufacturing & Sales - 60 Pik Rite Lane - Lewisburg, PA 17837

1-800-326-9763

When Service Life is Important,
Get the 25-Year NO Rust Guarantee

- **Dewatering Systems**
- **Composting Systems (ECS)**
- **BOD COD Reduction Systems**
- **Polymer Systems**
- **Financing Available**

**It's Smart to Protect Your Investment,
Get the SMART 25-Year Guarantee!**

Multiple Purchase Options Available with Financing
If you want experience, give John a call.
1-800-899-1802
P.O. Box 782265 • San Antonio, TX 78278
210-269-3910

www.smartdewatering.com

AMT
A Subsidiary of The Gorman-Rupp Company™

12 VOLT DC HIGH HEAD WASHDOWN PUMP

- 1 HP Washdown Duty Motor for Severe Operating Conditions
- Investment Cast 316 Stainless Steel, Cast Iron or Cast Bronze Construction
- All Models Equipped With High Efficiency Stainless Steel Impeller
- Discharge Port Rotates in 90° Increments
- Four Front Drain Plugs
- Maximum Flow 56 GPM
- Maximum Head 80 Ft. (35 PSI)
- Maximum Temperature 200° F



The AMT 12 Volt DC Washdown Pumps are designed for pumper, septic service, OEM, and marine applications requiring a DC motor. The motor has a one hour duty rating and is furnished with a grade 303 stainless steel shaft. Washdown Duty Pumps are available in a variety of construction and seal materials to meet your specifications. Pull-from-the-rear design for easy servicing without disturbing piping.

**Call us toll free at 888-268-7867 or visit our website
www.amtpump.com for more information.**

American Machine & Tool
A Subsidiary of The Gorman-Rupp Company
400 Spring Street
Royersford, PA 19468

ots
OFF THE SHELF

WANT A TRUCK THAT REALLY SUCKS?



Vacuum Trucks from Rocket Supply

The Amthor Matador Flat Vac
The Amthor Matador Flat Vac offers an exclusive improved tank design available in 5/16" aluminum, 1/4" steel and 1/4" stainless steel with capacities from 500 to 2000 gallons with full internal baffles. This unique body is used to service portable toilets and can carry 8 to 12 at one time, making it a very efficient vehicle. Features a rounded floor that allows for easy product drainage.

The Amthor Matador
The Amthor Matador offers an exclusive improved tank design available in 5/16" aluminum, 1/4" steel and 1/4" stainless steel with capacities from 500 to 7000 gallons. With full internal baffling and a heavier side shell than the competition, it allows for the absence of external rings, which provides a smoother looking tank when adding your brand or logo to it. Dumping options are also available.

For Excellent Price and Fast Delivery!

Rocket Supply Since 1959

Contact Us for More Details



Roberts, Illinois • 800-252-6871 • www.rocketupply.com



NORTHEASTERN MFG. & SALES INC.



4141 Airpark Dr.
Standish, Michigan 48658

Phone (989) 846-2700
Fax (989) 846-6381

www.northeasternmfg.com



The Modular Series Tank can be constructed to hold any combination of capacities along with the versatility of mounting locations. The features of this tank include a self-contained 70 cfm Conde pump with a 9 hp Honda engine with electric start, complete with 25 feet of 2" and 3" hose and fittings. Ready to work!



chempace corporation

www.chempace.com

Serving the Industry for Over 40 Years!

One-Stop-Solutions For PORTABLE SANITATION & SEPTIC & GREASE HAULERS

BUYING DIRECT ALWAYS EQUALS COST SAVINGS



Big Shot® Con2 & Con2 Plus

- Super Strength Concentrate
- Non-Formaldehyde
- Ideal for Summer Use

NEW FEATURES ON 3 GREAT PRODUCTS!

NEW FORMULA!

ENHANCED FRAGRANCE!

STRONGER DYE

Ultra PowrPak XL

Convenient Carry Pail
Effervescence

SEPTIC TANK ADDITIVES \$6 (Per Pkg)

LONG LASTING PINK CUBE \$160 (Per 4x5 lbs.)

Designed to last in hard to service liftstations/grease traps

NEW PACKAGING OPTION

SEWER FOAM \$59.75 (Per Pail)

Reduce solids and hydrogen sulfide odors - Economical approach to sewer maintenance.

BUY DIRECT CALL CHEMPACE 1-800-423-5350

PRODUCT SPOTLIGHT

High Tech II Deluxe Flush Restroom

By Ken Wysocky

With added floor space, molded-in components and stainless-steel bowl, the **High Tech II Deluxe flush restroom** from **Synergy World** aims to fill the niche between standard flush units and restroom trailers.

"This unit offers more of a home bathroom feel, as well as a higher rental value, which increases operators' profitability," says Stephen Brinton, the company's vice president. "We spent almost four years working with portable restroom operators that wanted a high-end flushing unit without stepping up into a much more expensive 'crowd pleaser' trailer unit."

The commercial-quality, stainless-steel, foot-activated flush bowl is one of the unit's primary features. Highlights include no exposed plumbing and an easy-access freshwater fill port, Brinton notes.

"Waste won't stick the way it does with a plastic bowl, and a water-seal flapper keeps waste out of users' sight, as well as greatly reduces odors," he explains.

The restroom is 8 1/2 inches wider than a standard restroom (52 1/2 inches compared to 44 inches) and is 48 inches deep and 91 inches high. A wall-mounted waste basket, which uses standard kitchen



garbage bags, keeps trash out of the toilet and contributes to the flush unit's 1,036 square inches of floor space, Brinton notes.

The flush unit weighs 299 pounds when empty. It comes with an 88-gallon waste tank with deodorizer fill lines, a 26-gallon flush water tank and a 10-gallon hand-wash tank. Other amenities include a foot-operated hand-wash station; a vertical, four-roll toilet paper dispenser that eliminates partially used rolls; a standard solar-pow-



ered light; an upper corner shelf; an 11-inch mirror; twin sheet, thermo-formed walls; molded-in ventilation slots; 10 washout ports; greater ground clearance for operators who use pallet jacks; a tinted, UV-resistant roof, runner grooves and top-to-bottom handholds for easier maneuverability.

"The flushing unit, which comes in medium tan, also offers a fresh, innovative look," Brinton

adds. A non-flushing model, equipped with a urinal and available in dark blue or green, is geared toward construction-site use.

"It provides more room for workers

encumbered by bulky clothing or tools," Brinton says.

For more information, visit www.portabletoilet.net or call 800/352-1986.

Zoeller Introduces Fusion Series Treatment System

The **Fusion Series Treatment System** from Zoeller Pump Co. combines anaerobic and aerobic digestion in three-bedroom (ZF450), four-bedroom (ZF600) and five-bedroom (ZF800) units. The drop-in units are designed for residential or commercial applications in new construction or retrofits. No septic tank is required, unless mandated by local regulations. There also is no media to change or remove. 800/928-7867; www.zoeller.com. ■

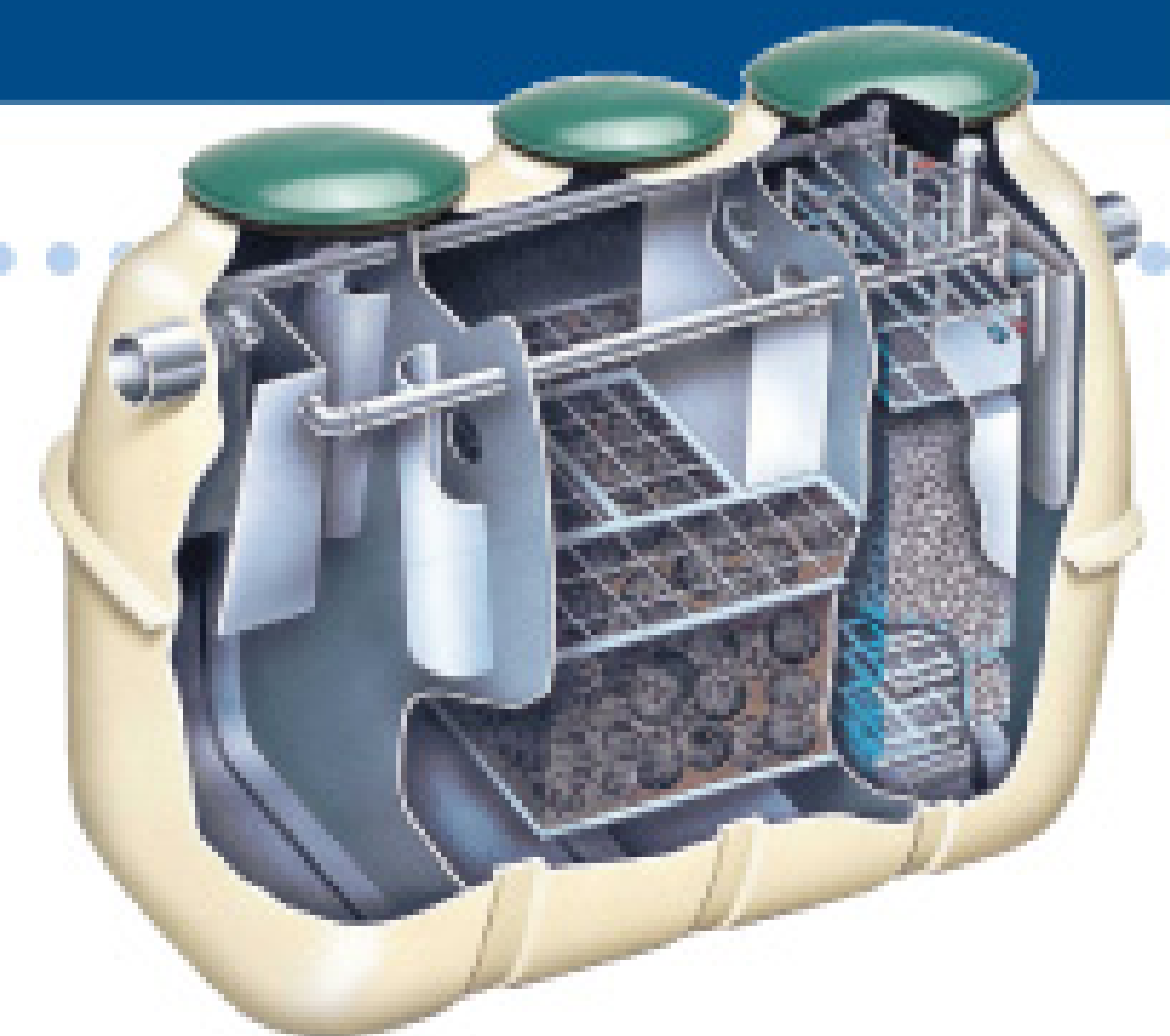

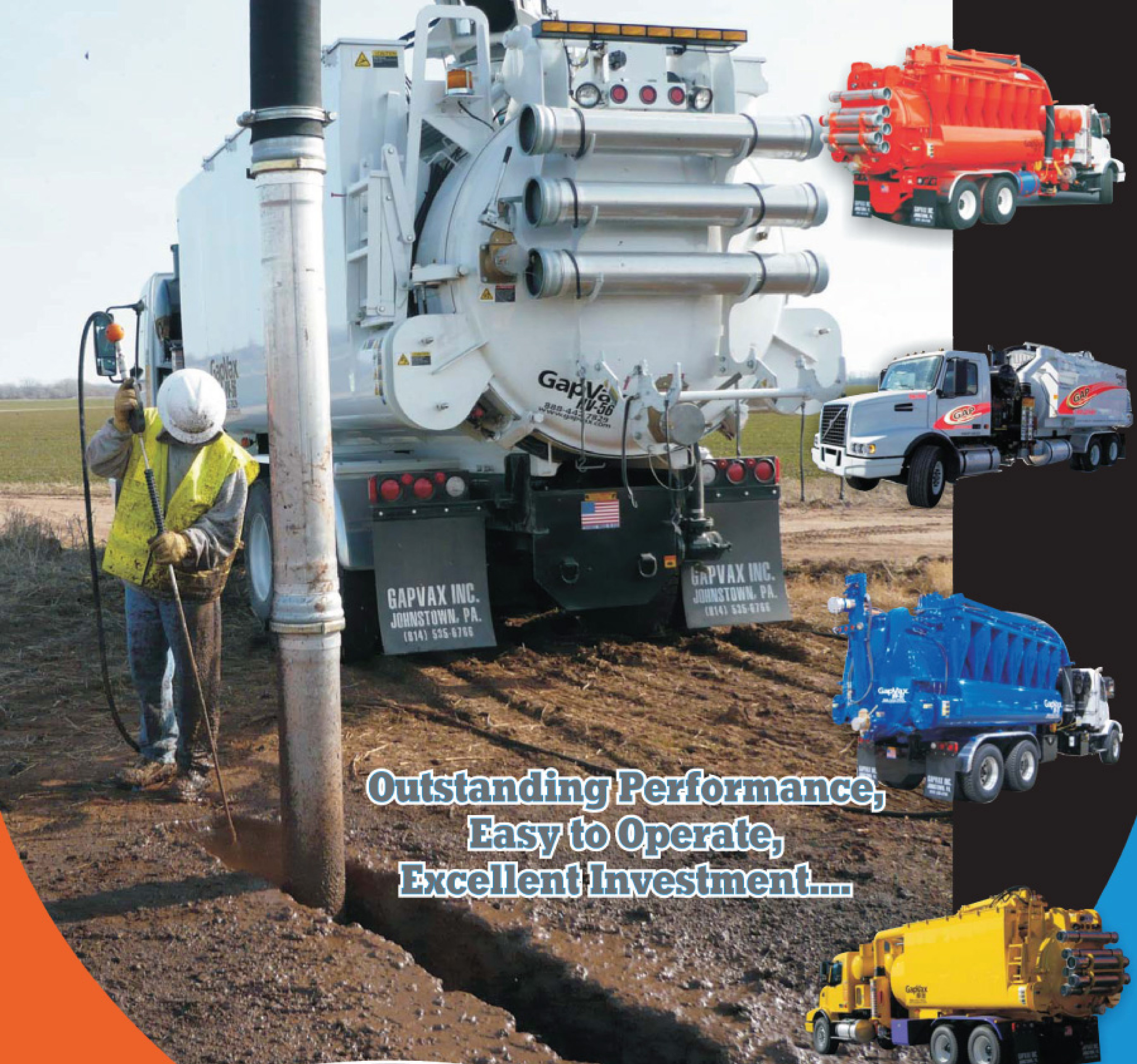

**Outstanding Performance,
Easy to Operate,
Excellent Investment...**

GapVax[®]
Johnstown, Pa 15902

www.gapvax.com

toll-free U.S./Canada 888-442-7829 or 814-5235-6766/fax 814-539-3617



OVERLAND TANK, INC.



DOT 407/412 ACID TRAILERS

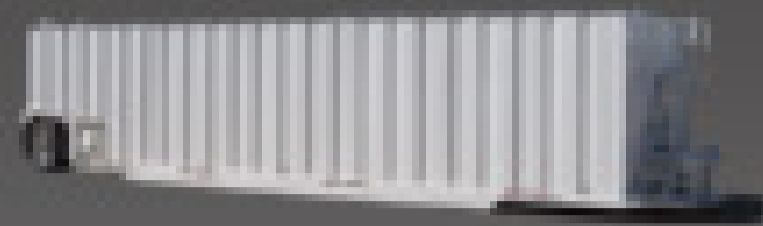

500 BBL PORTABLE FRAC TANK



STEEL TRANSPORT/KILL TRAILERS



TWIN DOT 407/412 ACID TANKS



ASME CODE VACUUM TRAILERS

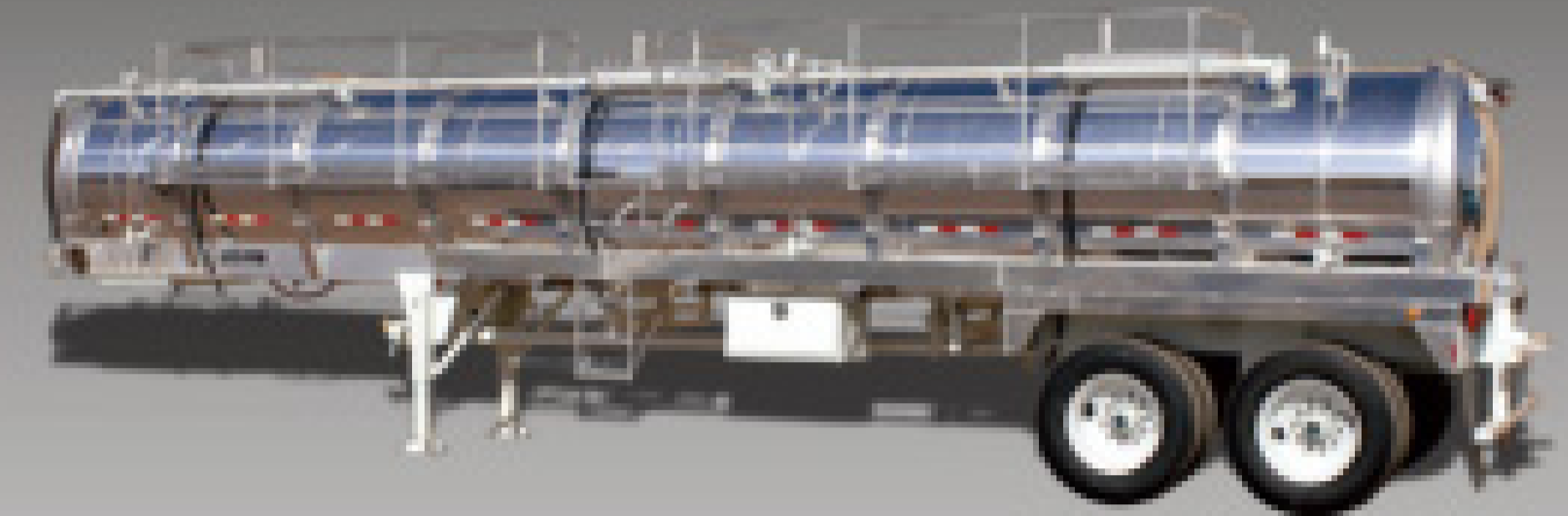

ALUMINUM VACUUM TRAILERS
ALUMINUM TRANSPORT TRAILERS



200BBL DOUBLE CONICAL CRUDE OIL TRAILERS



BOBTAIL VACUUM TRUCKS

IN STOCK

4725 FM 18 ABILENE, TEXAS 79602 WWW.OVERLANDTANK.COM TOLL FREE: 866.635.7132

435 GALLON VACUUM TANK



- 1/4" Aluminum Construction
 - Conde Super 6 Pressure Vac Pump with 5.5 hp Honda Electric Start
 - 12 Volt Water Pump
 - 300 Waste/135 Fresh
 - 25' Hose and Wand
 - 2" Sight Eyes in Waste
 - Sight Tube on Fresh Water
 - Completely Self-Contained
 - Ready to Work
- *OTHER SIZES AVAILABLE***

Robinson Septic Service Inc.

125 Rockrimmon Dr., Bellefonte, PA 16823 • t: 814.353.0263 • email: honeydippers@aol.com
1.800.252.3848 • www.robinsonseptic.com



When you receive *Pumper* each month there is no need to bluff.

Join 25,000 of your industry peers each month who welcome *Pumper*, for the unlimited value it brings them. Each issue will show you new tools, tips to save on expenses, money-saving deals and much more.

800.257.7222
www.pumper.com

Subscribe today to guarantee your winning hand!



1-800-333-9274 East * 1-800-786-9274 Custom
 1-800-351-7283 HONDA Parts * 1-800-964-9274
 1-800-454-9274 Open Till 7:00pm West

* Apply For 30 Day Terms Account
 * Low Interest Lease Plan
 * 5 Offices To Serve You
 * Free Lifetime Tech Support

SXMV4G40-B Triplex Pump
 Hollow 1" Keyway Shaft Bare



52708 - 4.0GPM 4000PSI **\$219**

Includes: Bolts & Dipstick

3+ SAVE
\$10 Each

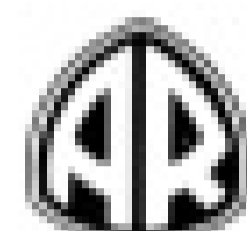

SXMV4G40-P Triplex Pump
 Hollow 1" Keyway Shaft Plumbed



54744 - 4.0GPM 4000PSI **\$279**

Includes: Chemical/ Soap Injector,
 Bolts & Dipstick

3+ SAVE
\$10 Each



10HP Briggs Intek I/C Engine
 1" x 3-21/32" Keyed Shaft

206432-0121 **\$489**
 Low Oil Startup, Recoil Start

205437-0198 **\$529**
 Recoil & Electric Start
 10 Amp Alternator



10Hp Recoil

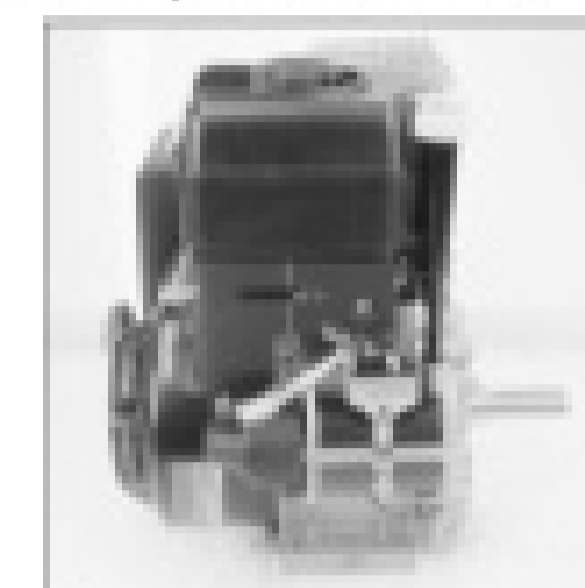

10Hp Electric

CAT 66DX40GI-B Triplex Pump
 Hollow 1" Keyway Shaft Bare

52949 - 4.0GPM 4000PSI **\$319**



Includes: Bolts,
 Spacers & Vent Cap

3+ SAVE
\$10 Each



CAT 66DX40GI-P Triplex Pump
 Hollow 1" Keyway Shaft Plumbed

54985 - 4.0GPM 4000PSI **\$389**



Plumbed Includes:
 Chemical/Soap Injector,
 Bolts & Vent Cap

3+ SAVE
\$10 Each



13HP Zongshen Engine
 1" x 3-21/32" Keyed Shaft

ZS188F-13Hp **\$339**



Fuel Efficient
 Non-Transistorized Ignition
 Adjustable Throttle
 Low Oil Shutdown

Recoil ZS OHV Engine

RKV Triplex Pump
 Hollow 1" Keyway Shaft Bare

52716 - RKV4G40-B - 4.0GPM 4000PSI **\$309**
 52719 - RKV45G40-B - 4.5GPM 4000PSI **\$399**



Includes: Bolts & Dipstick

3+ SAVE
\$10 Each



RKV Triplex EZ Deluxe
 Hollow 1" Keyway Shaft EZ Start Plumbed

55794 - RKV4G40-EZ - 4.0GPM 4000PSI **\$389**



* Deluxe, Includes:
 Easy Start Feature,
 Bolts & Dipstick

3+ SAVE
\$10 Each

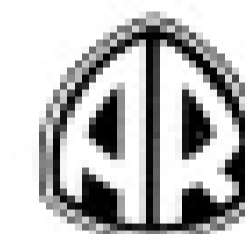

16HP LT Engine
 1" x 3-21/32" Keyed Shaft

LT390B - Recoil Start LT Engine **\$319**
 LT390BE - Electric Start, 1.5/1.8 Amp 12 Volt **\$399**



Fuel Efficient
 Non-Transistorized Ignition
 Adjustable Throttle
 Low Oil Shutdown
 These Models Have
 An Auxiliary Recoil

TX1510A-P Triplex Pump
 Hollow 1" Keyway Shaft EZ Start Plumbed

54893 - 4.0GPM 3750PSI **\$339**



* Deluxe, Includes:
 Easy Start Feature
 Chemical/Soap Injector,
 Bolts & Dipstick

3+ SAVE
\$10 Each



HV4G40-EZ Triplex EZ Deluxe
 Hollow 1" Keyway Shaft EZ Start Plumbed

55612 - 4.0GPM 4200PSI **\$319**



* Deluxe, Includes:
 Easy Start Feature
 Chemical/Soap Injector,
 Bolts & Dipstick

3+ SAVE
\$10 Each



13 & 15HP Kohler Engine
 Command, Horizontal Recoil Start,
 Low Oil Shut Down With Muffler & Fuel Tank

CH15T-44512 - 15Hp 1"x3 25/32" Shaft **\$669**
 CS12T-941520 - 13Hp 1"x3 25/32" Shaft **\$519**



13Hp



15Hp

RKV Triplex Pump
 Hollow 1" Keyway Shaft Bare

52721 - RKV50G40-B - 5.0GPM 4000PSI **\$429**
 52724 - RKV55G40-B - 5.5GPM 4000PSI **\$439**



Includes: Bolts & Dipstick

3+ SAVE
\$10 Each

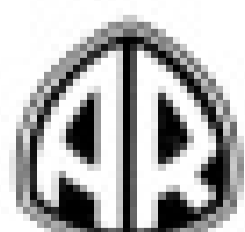

RKV Triplex EZ Deluxe
 Hollow 1" Keyway Shaft EZ Start Plumbed

55795 - RKV50G40-EZ - 5.0GPM 4000PSI **\$499**
 55797 - RKV55G40-EZ - 5.5GPM 4000PSI **\$509**



Deluxe, Includes:
 Easy Start Feature,
 Bolts & Dipstick

3+ SAVE
\$10 Each

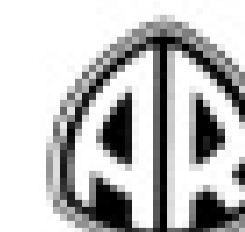

13HP Honda GX Engine
 1"x3 21/32" Horizontal Keyed Shaft

GX 390QA - 13HP Recoil **\$665**
 GX 390QAE - 13Hp 3 Amp **\$899**
 GX 390QNE - 13Hp 10 Amp **\$939**



HONDA

Low Oil Shutdown, With Muffler
 & Fuel Tank
 These Models Have An Auxiliary Recoil



www.WaterCannon.com
 Drain Cleaning Systems
 Jet 75' Kit
\$99

Yes, You Can! Water Cannon Supports Micro Manufactures Worldwide, We
 Have OEM Discount on Engines, Pumps, Frames, Quick Connects, Hoses,
 Trigger Guns, Nozzles, Wands & A Full Array of Parts & Accessories

10280 Brecksville Road Brecksville, Ohio 44141



R.A. ROSS N.E., INC.

INDUSTRIAL & TRUCKING BLOWERS • VACUUM PUMPS • SALES, SERVICE, & INSTALLATION



We have a **FULL SERVICE REPAIR SHOP** capable of servicing and repairing a wide variety of different makes and models of blowers and vacuum pumps from all your top manufacturers including
**Tuthill/MD • Drum • Gardner Denver • Cycloblower • Duroflow • Sutorbilt • Roots • Hibon
 Fruitland • Moro • Masport • Wittig • NVE Challenger • Jurop • Battioni • Presvac
 Blackmer • Roper • Ranger • Viking**



NVE FRUITLAND CHELSEA
A DIVISION OF Parker

Vacuum Pumps • Components • PTO's • Hydraulics • Valves • Manways • Gear Boxes • Mufflers • Silencers • Gauges • Camlocks • Hose

TOLL FREE 1.800.678.4581 PHONE 440.546.1190 FAX 440.546.1188 EMAIL RAROSSNE@RAROSSNE.COM WEBSITE WWW.RAROSSNE.COM



**4000 Gallon
 pumper on a 2007
 M2 Freightliner**

Tank: Bright finish aluminum-5/16" #5454 shell and heads 76" Dia.

Pumping system: Jurop LC420 water cooled pump

Chassis: Freightliner M2-54,000 GVW, C-7 Caterpillar 300 H.P., 10 speed transmission-14,600 front axle-40,000 air ride rear axle.

**2800 Gallon
 pumper on a
 2007 International**

Tank: Bright finish aluminum-5/16" #5454 shell and heads

Pumping system: Masport HXL 15 (350 CFM)

Chassis: International 4300-33,000 GVW, 245 HP DT466-RDS 3500-12,000 front axle, 21,000 rear axle.



**WHITE RIVER
 DISTRIBUTORS, INC.**
 BATESVILLE, ARKANSAS

(800)-548-7219
 (870)-793-2374
 www.lpgbobtails.com

Septic Tracker

Septic software for pumpers. Designed for a pumper, by a pumper.

- ◆ See all of a customer's information and history on one screen.
- ◆ Generates completed reports, including Pumping, Customer History, Income, a customizable report by criteria, and much more ...
- ◆ Scheduling Calendar, Work Orders, Dispatching, Invoices, Reminders, Past Due Accounts, Disposal Tracking, Employees, Vehicle Service, Mailing Labels and more ...
- ◆ You can use Septic Tracker with portable toilet rentals, drain cleaning, and any other service. You name your services.
- ◆ Use the **FREE DEMO** for 30 days. If you decide to purchase the program, you can activate your demo permanently. No need to re-enter data!!

Toll Free: 1-888-308-0651

www.septictracker.com loren@septictracker.com

Refrigerator Magnets \$.42

**Straight Line
 Setup
 FREE!**

1-800-758-2743



**Pumper Truck Shape
 Actual Size 4 1/2" x 2"**

Minimum 500

**Call:
 Sholom**
 for pricing
**Quantity
 Discounts**

2-color Imprint

Mid Continent Truck Sales, Inc.

891 Adkins Hill Rd. • Norman, OK 73072 • 405-329-5365 • Fax: 405-329-5381 • After Hours: 405-288-6502 • www.vacuumtrucksales.com

Trucks - Trailers - Vacuum Tanks - Pumps



2001 IH 4700, DT466E, Allison auto, non-CDL, air brakes, new MEC 6500 vacuum pump, new 1100/400 vacuum tank.



2000 Freightliner, Detroit 60 series (430/470 hp) w/fresh overhaul, 10-speed, double frame, new Wally 753LNHR vac pump, new 3400 gallon vacuum tank.



2001 Freightliner FL70, Cat 3126 (230 hp), 6-speed, 33,000 lbs., double frame, new MEC8000/PAL vac pump, new 2300 gallon vacuum tank.



2001 Freightliner FL70, Cat 3126 (190 hp), 5-speed, non-CDL, new Masport HXL75V vac pump, new 1600 gallon vacuum tank.



1998 Freightliner FL60, Cummins 5.9 (210 hp), 6-spd., Masport H75V vacuum pump, General 47 series triplex, 1100/200 gallon vacuum tank.



LET US QUOTE YOUR NEXT VACUUM TANK!



1990 IH 9400, Cummins NTC350 w/fresh inframe, 9-spd., new Wally 753LNHR vac pump, 3500 gallon vacuum tank w/full opening rear door.

MID CONTINENT TRUCK SALES

manufactures and stocks all necessary components to complete your vacuum system. Whether it's pumps, valves, moisture traps, oil catch mufflers, pump frames, etc.

CALL US BEFORE YOU BUY!

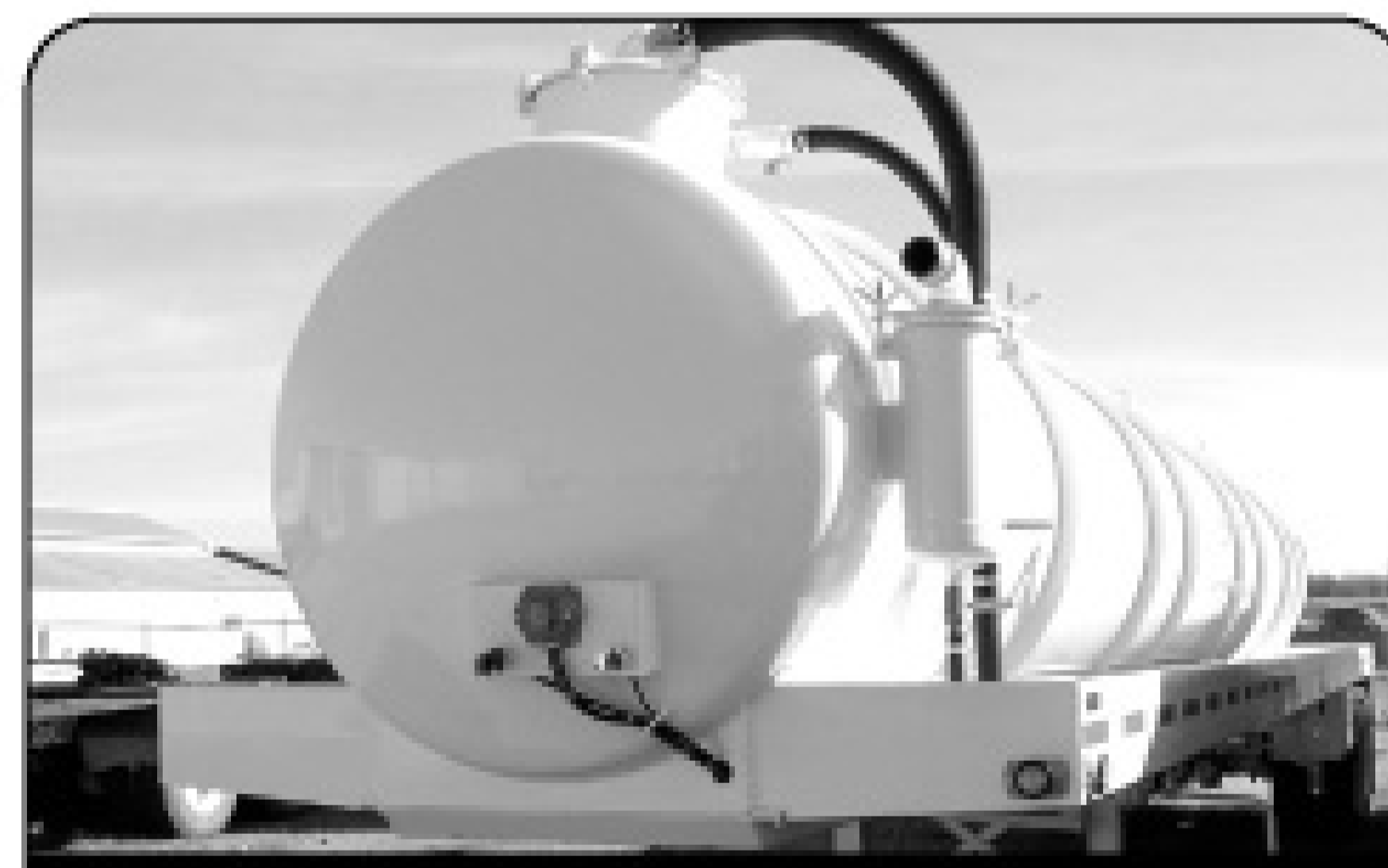

New Fluidmaster 5460 gal. vacuum trailer in stock. Also several used vacuum trailers in stock.

KP
Pumps
Since 1946

NVE

BOWIE



AUTHORIZED DISTRIBUTOR



Masport

vallenstein
vacuum pumps

FLUID AND SLURRY
PUMPS

WE CARRY MOST BRANDS OF VACUUM PUMPS AND PARTS!



WE WILL BUILD TOILET UNITS TO YOUR SPECS!

Call DAVE PERRY for TRUCK quotations and CHUCK RODGERS for TANK quotations.

McDermott Honored for 50 Years of Service

Tom McDermott Sr., chairman of A.I. McDermott Co. Inc., was recognized for 50 years of leadership and service to the water system industry during the company's 63rd annual dealer meeting at its Oshkosh, Wis., headquarters. During his tenure, the company has expanded from one location in Oshkosh to four full service locations, including branches in Wausau, Green Bay, and Muskego, Wis. The meeting included more than 30 manufacturer exhibits as well as morning and afternoon training sessions.



Tom McDermott Sr. (left) was presented the golden McDermott pitcher pump by his son Tom McDermott Jr. for 50 years of service to the water system industry.

Amthor Named to Magazine's List of Fantastic 50 Companies

Amthor International has been named to the Fantastic 50 list of companies by *Virginia Business* magazine and the Virginia Chamber of Commerce. The award is a statewide competition that recognizes Virginia's fastest-growing companies, based on a four-year growth rate. Companies also had to achieve a profit in their most recent fiscal year. Amthor, a manufacturer and distributor of tanks for trucks, employs approximately 80 workers and runs two shifts at its Gretna, Va., facility.

Hannay Reels Marks 75th Anniversary

Founded by Clifford Hannay in 1933, Hannay Reels marks its 75th anniversary this year. From its first manual-crank reel to the production of about 3,600 reels a year from a new manufacturing facility in 1952, Hannay continues to grow. Today the company, located in Westerlo, N.Y., ships more than 70,000 reels worldwide from its headquarters that was recently expanded to 44,000 square feet, allowing for larger fabrication, assembly and shipping departments.

Peat Joins Premier Tech Environment

Raymond L. Peat has been named commercial and community market development director for the Environmental Technologies Group at Premier Tech Environment. Peat served as president of the National Onsite Wastewater Recycling Association from 2004 to 2006 and has a degree in chemistry from Emporia State University in Kansas.

Wastequip Launches Companywide Reorganization

Wastequip Inc. has launched a companywide reorganization designed to make it more efficient and an environmental leader in the waste industry. "Our focus going forward will be to improve customer service and reduce costs through practices involving reduced energy consumption, CO2 emissions and increased recycling," Bob Rasmussen, president and CEO, said. The company already has saved more than \$250,000 in energy costs and reduced CO2 by 600 tons through the installation of energy-efficient lighting and HVAC controls at its Winamac, Ind., facility. The Cleveland-based company also has restructured its Steel Group into a newly formed Container Division and created a Technical Products Division for its hoists and compactors. Driven by a focus on LEAN Six Sigma programs, plant managers are being trained in LEAN practices, while several older and less efficient facilities are being closed. ■

Non-CDL
19,500 GVW to
66,000 GVW
Septic / Grease Trap
Portable Restroom
Vacuum Service



Complete
'Work Ready'
IN STOCK
Selection!

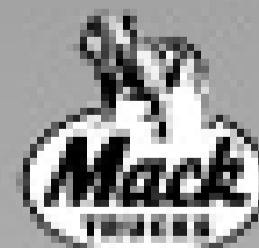
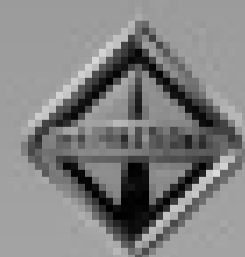

Contact: Mark C. Langworthy 800-261-9009
e-mail: mlangwor@tanktruckservice.com www.tanktruckservice.com
Tank Truck Service & Sales, Inc.
25150 Dequidre, Warren MI 48091



FREE to Qualified
Industry Professionals!

Each month, PRO™ magazine provides portable sanitation professionals with valuable stories, time-saving and moneymaking insights and targeted advertising to help you work smarter and increase the bottom line.

Subscribe online at www.promonthly.com
or Phone 800-257-7222 TODAY!

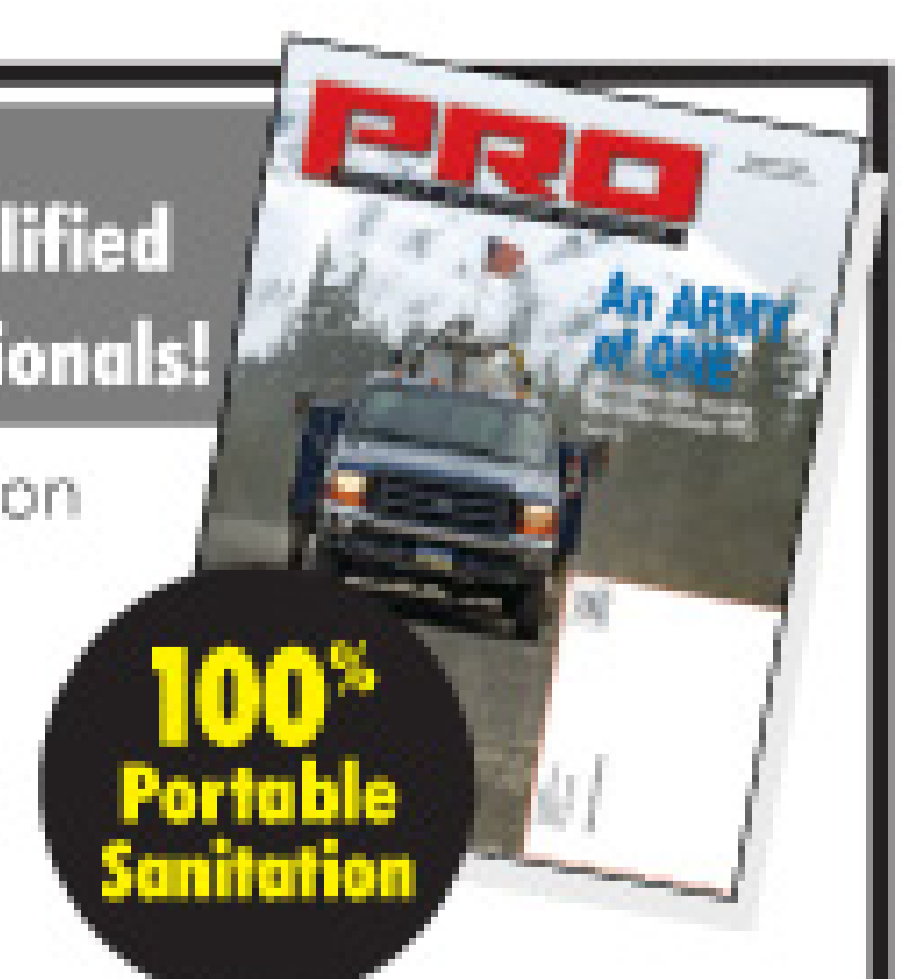

100%
Portable
Sanitation

ADVERTISING

REMINDER POSTCARDS: Advertise full color postcards of your truck, service or products. Great marketing tool. Visit www.postcardprinting.com. Toll Free 1-888-334-4553. (PBM)

BUSINESSES

FOR SALE: Well established septic tank cleaning and portable restroom rental service. Excellent income, excellent growth potential. Established client list. Located in Wetzell Co., West Virginia. For more info. call 304-386-4453. (PTBM)

Septic pumping, installation and roofer jetter business. Northern Minnesota. Retiring after 18 years. 1999 Imperial 2500 tank, Battioni pump, additional equipment, 1,200 customers. \$390,000. Call 218-365-4041. (PBM)

BUSINESSES WANTED: Septic pumping, grease trap, drain cleaning and other ancillary businesses wanted. We are buying well run businesses in New England, Mid-Atlantic and Florida. All opportunities will be given proper consideration. Confidentiality ensured. Will move quickly for the right opportunity. Serious inquiries only. Please contact Richard Bedard @ Blue Water, 617-326-3344 or rbedard@bwseptic.com. (CPBM)

FOR SALE: 23-year-old restaurant service company specializing in hood system cleaning and ceiling restoration. Serving WV, OH and KY. Large loyal customer base. Grossing average \$500,000. All vans, equipment and experienced service techs in place. \$300,000. Will train. 304-372-2158. (CP7)

Septic Tank Pumping & Grease Business in Tennessee: Owner retiring, family owned, in business for 20 years. Two trucks: 2002 Peterbilt, 3,000 gal. tank; 1999 Chevrolet, 2500 gal. tank, garage kept and regularly maintained. Great opportunity for growth. \$160,000 last year; \$200,000 this year. Residential & commercial. \$250,000. 865-579-5699. Ask for Bob or Patti. (PBM)

BUSINESSES

Well established pumping/repair/grease trap business for sale. State approved disposal facility and inert landfill on 27 acres. Awesome workforce available. All new equipment. 706-234-9937. Serious inquiries only please. (CP6)

Septic and grease pumping business in Arizona. Commercial and residential. Two trucks: 3200 gal. & 2000 gal., 9000 gal. storage, 5200 gal. aluminum tank trailer, mini track hoe w/trailer, camera and locator, more. Established 8 years. Asking \$175K. Email: business4saleinAZ@gmail.com. (P6)

Family owned pumper and septic installation business offered in sunny, warm, New Mexico. Large customer base, state mandated pumping on all home transfers. \$150-\$300K yearly income possible. Asking \$140K negot. Serious inquiries only. 1-575-434-5158. (P6)

Long Island, New York: For Sale: Cesspool, Septic, Sewer and Drain Cleaning Company For Sale. 2 pump trucks, 2 porta-pottie trucks (service and delivery). Quality workmanship, has established 3000+ loyal customer base. Great opportunity for right person. Jump in on busy season! Money maker! Debt free! Office/shop/yard also available. Call for more information. 631-472-0677. (PBM)

FOR SALE: Septic pumping business located in lake region, central New Hampshire. 20 years in business. Government contracts. Three trucks. Owner retiring. \$77,000. Call 772-664-1931 or 603-279-4063. (P6)

FOR SALE: Septic and Portable Toilet Business located in White Mountains, Arizona. 150 toilets, 2 ADAs, 3 trucks. For more info, respond to: 11448 East Monte Ave., Mesa, AZ 85209. (PBM)

FOR SALE: PORTABLE TOILET BUSINESS located in Central, IL. Family owned for 30 yrs. 3 pump trucks, 1 waste hauler, 3 toilet trailers, 400 plus Olympia Fiberglass toilets & 20 handicap units. Serious inquiries call 217-875-2240 or 217-768-4550. (P8)

BUSINESSES

HOT WATER SHOWER BUSINESS: Good used warm water PolyJohn showers, like new. Two units mounted on trailer with Gen. pump & tanks, "self-contained." One on trailer, requires 120/water service. Open to offers on all. **Phone 250-428-2181.** (P6)

FOR SALE: SOUTHERN CALIFORNIA SEWER BUSINESS: Sewer and septic company in Redlands, California established late 1940s. Most respected sewer company in area. A lot of room for growth. In center of nation's largest housing development. Owner retiring; can assist with transition of company for at least one year. Equipment includes: 3 pump trucks (one needs work), 2 backhoes, 2 skid steers, 2 mini excavators, 1 dump truck, 1 equipment trailer, 1 skip loader. Also miscellaneous buckets, compactor, generator, air compressor and other tools. \$825,000. Please contact Tim Patrick 909-795-6164. (P7)

BUSINESS OPPORTUNITIES

GREAT BUSINESS OPPORTUNITY: Would you like to start a septic and sewer cleaning business in Florida? I have the license - will sponsor. For more information call Larry at 931-277-5541 or 931-248-1284. (CPBM)

National Grease Recycling Inc. Let us teach you how to recycle restaurant's waste fryer grease and oil (yellow grease) only. **No trap grease.** Big \$. Over 30 yrs. experience. Will guide you through complete process from collection to processing to marketing to end users. Don't lose your trap business to competitors that offer both services. Call for information. Dewey Walker. 813-752-9535 or 813-758-2552. (PBM)

SMALL PLUMBING COMPANY WITH BIG TIME POTENTIAL needs partner/investor. We have offices in Georgia & Alabama. All work is service. No new construction. National accounts that only seem to grow. If interested call 678-522-2367. (CP6)

BUSINESS OPPORTUNITIES

WWW.ROOTERMAN.COM. Franchises available with low flat fee. New concept. Visit web site or call **1-800-700-8062 x26.** (CPBM)

Attention PolyJohn Owners: Receive a **free CD-Rom** of our products to use in your company marketing efforts. Ask your PolyJohn business coach in your area to send you this material today. 1-800-292-1305 Kell. (PBM)

COMPUTER SOFTWARE

Pumper Plus Billing Software: Regularly \$795. Mention this ad in Pumper.com and purchase for only \$595. Pumper Plus is a billing software package from Galaxy Systems, www.galsys.com/pumperdemo.asp, that handles billing for septic pumping and portable toilet service-type companies. Inquire at solutions@galsys.com or call 800-985-3029. (PBM)

WINTAC is the #1 software for scheduling, billing, CRM, service tracking, accounting, marketing, vehicle management. FREE demo at **www.wintac.net.** 1-800-724-7899. (P6)

DEWATERING

2000 Flo Trend 12-yd. box mounted on 5th wheel trailer with 100 gallon liquid polymer injection system. Also Honda 3" trash pump. Top totally enclosed with 3 hatches. \$15,000. 803-385-8681. (CP6)

Buy - sell - trade - lease: Filter presses, belt presses, vacuum filters, filter cloth, dewatering bags, tanks, mixers and more! Call Waste Treatment Equipment Specialties at 440-808-8844. **www.wescoequip.com.** (PBM)

Two 40-yd. dewatering boxes and one polymer mixing and pumping units with Seepex sludge pumps. 5 years old. Excellent condition. Asking \$20,000/box and \$25,000/pumping unit. Call 1-506-672-2100. (PBM)

DEWATERING

Used Aqua-Zyme Dewatering Unit (1 yr. old) 30-yd. Dewatering Box; Polymer dosing system; Hoses and barrel of polymer (all included). Selling for what we owe. 865-927-7646. (P7)

Alar Auto-Vac 660 for sale. Skid mounted on trail mobile trailer for mobility. Call Allan for more details. 902-895-8559. (P6)

DRAINFIELD RESTORATION

Slightly used Terralift for sale. Only 13 hrs. Call Allan for more details. 902-895-8559. (P6)

DRAIN/SEWER CLEANING EQUIP.

DrainCleaningSupply.com. Sewer and drain cleaning equipment. Cable, blades and more. Rapid shipment. **DrainCleaningSupply.com.** (CP8)

2000 Freightliner FL70 with 00' Stetco 950T catch basin cleaner. Cat 250 hp engine with Fuller trans. In excellent condition. The 950T body has never been used!! \$35,000. KLM Companies 617-909-9044. (P6)

DREDGES

1988 Pit Hog dredge w/John Deere turbo chrg. diesel engine, excellent, uses no oil. 2200 gal. flow, runs great! \$45,000. Also available 2000' 6" hose or 2000' alum. pipeline. 641-623-3047. (P6)

EXCAVATING EQUIP.

CONVERT RUST NOW! Pro-Tek 2-in-1 rust conversion. One-step application! Call now for free info. 631-285-7640. (PM6)

HAZARDOUS WASTE UNITS

2000 Kenworth T300 cab and chassis with a Presvac 2010 US gallons, DOT certified vacuum tank. **In stock.** (Stock #4675C) **www.VacuumSalesInc.com,** (888) **VAC-UNIT (822-8648).** (PBM)

HAZARDOUS WASTE UNITS

2009 Freightliner 120 steerable tri-axle with new Presvac Powervac 3,800 cfm, DOT 412, wet/dry vacuum unit. 3,200 gallon tank with full open rear door with top loading boom. 450 hp MB engine with aluminum wheels and fully loaded. Buy or rent. KLM Companies/KLM Rentals Inc. Call 781-934-5437. (P6)

(2) 1995 Tremcar 7,000 gallon transport trailer. Pre-owned Tremcar 7,000 gallon S/S, DOT 407 transport tank trailer. **Two units in stock.** (Stock #0701C; 0702C) **www.VacuumSalesInc.com, (888) VAC-UNIT (822-8648).** (PBM)

2000 Ford F-650 cab and chassis with a Presvac 1200 US gallons, DOT certified vacuum tank. **In stock.** (Stock #5721C) **www.VacuumSalesInc.com, (888) VAC-UNIT (822-8648).** (PBM)

1997 Peterbilt 379 heavy spec with a 3200 gallon, carbon steel, DOT certified, **Cusco master vac** wet/dry industrial vacuum loader with dual baghouse, PD blower, rotary vane vacuum pump. Full open rear door dump unit. Very clean. (Stock #1499V) **www.VacuumSalesInc.com, (888) VAC-UNIT (822-8648).** (PBM)

2009 Sterling LT9500 triaxle with a new Presvac, **Powervac** 3800, 3,250 gallon (US), DOT, wet/dry industrial, vacuum tank loader. (Stock #13336) **www.VacuumSalesInc.com, (888) VAC-UNIT (822-8648).** (PBM)

2000 Mack RD686 with Presvac 4,000 gallon MC307/312 DOT certified full open rear door tank. Mack 350 hp engine with Fuller 10-spd. 44K rears, 18K front. Excellent condition. Must see. KLM Companies Ph 617-909-9044. (P6)

2008 New Presvac 5,500 gallon, carbon steel, DOT 412, vacuum tank trailer with PVB750 and Deutz diesel engine package. (Stock #13325) In production for May! **www.VacuumSalesInc.com, (888) VAC-UNIT (822-8648).** (PBM)

1990 Presvac 5,000, **stainless steel** DOT certified vacuum tank trailer with PV750 pump, Deutz diesel engine package. Mirror type polish finish. (Stock #5008V) **www.VacuumSalesInc.com, (888) VAC-UNIT (822-8648).** (PBM)

HAZARDOUS WASTE UNITS

1994 Mack RD686ST heavy spec **triaxle** with Presvac 4400 gallon carbon steel 2-compartment (1200/3200) DOT certified vacuum tank unit with Masport water-cooled pump. Excellent truck; very well taken care of. (Stock #5371C) **www.VacuumSalesInc.com, (888) VAC-UNIT (822-8648).** (PBM)

2009 Peterbilt 340s **loaded with every option except with auto-matics** with a new Presvac 3200 gallon carbon steel, DOT 412 certified, **full open rear door, dump style units.** PVB750 vacuum pumps. (Stock #13335 A,B,C&D) In production for May/June. **www.VacuumSalesInc.com, (888) VAC-UNIT (822-8648).** (PBM)

JETTERS-TRAILER

USJ 4018-300 trailer power pullout, wireless remote, rpm 960, hp 50, psi 4000, gpm 18. Used 37 hours, 5-head pressure washer wand, 2006 model. Asking \$28,000. Call 423-595-3343. (CPT7)

1993 Sreco model HV2060 trailer jet, 35 gpm, 2000 psi, Myers pump, 500' of 3/4" hose, 600 gal. plastic water tanks. Was a city owned unit. 714-639-8352. **www.empireequip.com.** (CPBM)

1991 Ram Rodder Jetter. Myers pump. 300 gallon water tank. 4 cyl. gas motor. Hose & heads included. \$5,750. 770-443-0131. Atlanta. (CP8)

New PipeHunter Model 38T44 jetting unit, trailer mounted unit, w/335 Poly water tank, 4,000 psi @ 25 gpm, 600' of hose and attachments. **In Stock!!!** (Stock #13317) **www.VacuumSalesInc.com, (888) VAC-UNIT (822-8648).** (PBM)

2 SECA trailer jets. Both have Myers 35 gpm, 2000 psi pumps. New paint on both. Located in Dallas. 972-938-1905. **www.empireequip.com.** (CPBM)

JETTERS-TRUCK

1997 Sreco HV 2000 truck jet, 65 gpm, 2000 psi water pump, 1500 gallon aluminum water tank. Was a city owned unit. Located in Dallas. 972-938-1905. **www.empireequip.com.** (CPBM)

JETTERS-TRUCK

2006 GMC TC6500 cab & chassis truck mounted jetting unit with JET EYE camera system, 3,000 psi @ 50 gpm, 1,000 gallons water, 600' hose, 500 cfm blower, debris tank and attachments. (Stock #13234) **www.VacuumSalesInc.com, (888) VAC-UNIT (822-8648).** (PBM)

1986 CHEVY C-65 Cat. Diesel 175K, 5-speed manual split shift. New brakes and tires. Pump-Meyers D-65, 2000 lbs @ 65 GPM. One hour on rebuild. Perkins diesel. 1500 gallon tank. Good hoses and nozzles. Ready to work. \$25,000 (a steal). 770-527-0376. (P6)

1998 Vactor water jet on a Ford F-800, 17,338 miles, 65 gpm, 2000 psi pump, new paint. Truck is like new. 972-938-1905. **www.empireequip.com.** (CPBM)

JET VACS

2002 - 1991 Vactor 2100s in stock and ready to work. Models available equipped with either PD or fan style blower, 80 - 60 GPM pumps, mostly fully loaded, ex-municipal units with low hours and miles. Call Joe 312-208-6373. (P6)

1995 Vactor 2115, PD blower, 80 gpm, 2500 psi pump, 15-yd. debris tank. New paint. 972-938-1905. **www.empireequip.com.** (CPBM)

1994 Vactor GMC white cabover, Cummins 6 cylinder x 2, 1000 gallons - 5 yards, dual fans, excellent condition. \$70,000. OBO. Contact Bill 866-744-9921. (CP6)

1994 VacCon model V311-TA, 3-stage fan, 11-yd. debris tank, 50 gpm, 3000 psi pump, new white paint. Was city owned. 972-938-1905. **www.empireequip.com.** (CPBM)

2003 Sterling LT7501 with a Vac-Con VPD4216LHA/1300 16 cubic yard debris body and a 1300 gallon water capacity combination vacuum jetter unit. This unit has been very well maintained. (Stock #4648C) **www.VacuumSalesInc.com, (888) VAC-UNIT (822-8648).** (PBM)

Vac-Con model VPD4209THA on a 1997 Ford, **PD blower**, 4200 cfm, articulating hose reel, extendible boom, new white paint. Was a city owned unit. In excellent condition. 972-938-1905. **www.empireequip.com.** (CPBM)

JET VACS

COMING SOON: 2002 Vactor 2103, 2002 Vactor 2112 PD unit, and a 2004 Aquatech B-10. 972-938-1905. (CPBM)

Jack Doheny Supplies Inc. offers a full range of late model combo units and DOT industrial vacuum loaders. Call us @ 1-800-3DOHE NY. (CPBM)

1998 Vactor 2110 on a Freightliner FL80, 28,213 miles, 2-stage fan, 80 gpm, 2,000 psi pump off system accumulator. Was a city owned unit. Located in Dallas. 972-938-1905. **www.empireequip.com.** (CPBM)

1997 VacCon V390THA on a Ford, 3-stage fan, articulating hose reel, extendible boom, new white paint. Located in Dallas. 972-938-1905. **www.empireequip.com.** (CPBM)

1991 Vactor 2110 on Ford L-8000, single fan modified with a hydro excavation water pump in addition to the original sewer clean out pump, 8' boom, 61,883 miles. \$35,000 OBO. 858-792-2479. (PBM)

1998 VacCon V312THA on a Ford LT8000, 3-stage fan, 65 gpm, 2000 psi pump, extendible boom, articulating hose reel, 12 yard debris tank, new paint. Was a city owned unit. Located in Dallas. 972-938-1905. **www.empireequip.com.** (CPBM)

Low hours, 1995 Vac-Con, 12-yd. debris, new water pump, newly rebuilt Roots blower, auto. trans., AC, tank vibrator, privately owned. \$65,000. 1-800-930-1123 or 954-981-2133. (CPBM)

2002 VacCon V390LHA on a Sterling L7501, articulating hose reel, 10' extendible boom, 3-stage fan, pump-off system, 65 gpm, 3000 psi pump, new paint, excellent condition. Located in Dallas. 972-938-1905. **www.empireequip.com.** (CPBM)

LEASE/FINANCING

BSM Financial Group is a nationally recognized finance company. We offer flexible payment schedules for all types of equipment new or used. Trucks, pumps, jettors, portable toilets, and software easily financed. We do first time start-ups, established businesses, and challenged credit. **Call Brett at 877-524-7972 or email brett@bsmfinancialgroup.com.** (PBM)

LEASE/FINANCING

Capital Connection, the leader for sanitation equipment leasing and financing, provides prompt service and the best rates in the industry. We finance all types of equipment from jettors, restrooms, to trucks. We do it all. Call 253-224-1100. (P6)

North Star Commercial Credit: Commercial Loans for Trucks or Equipment. Flexible purchase programs to fit your budget. 21 yrs. in the industry. Contact **Tom Myers - 877-804-2274.** (CPBM)

EASY FINANCING! Specializing in new or used Trucks and Heavy Equipment. Start-ups welcome. Call IRON CAPITAL at 1-877-982-5111 or **www.Iron-Capital.com.** (P6)

Buying/Selling? We finance both. 100% financing, lowest payment. 6 months no payment. Trusted company who listens to all credit story. 888-798-3976. (P6)

MISCELLANEOUS

Top quality aerators at wholesale prices. We have replacement units for most name brands and also carry Linear Regenerative Rotary Vane pumps. Flagg Air, Gast, Thomas, FPZ, Secoh, Medo and more. Call a company that understands aerators and aeration systems. Septic Services Inc. 800-536-5564. (CPBM)

DISCOUNT ALUMINUM: ARE YOU PAYING TOO MUCH? 1,000 lb. minimum quantity. 5052/5454/5083/5086. .063 - 5.0" thick. All widths. Contact Jayson. 1-888-540-0066. (PBM)

PARTS & COMPONENTS

PARTS & SERVICE for vacuum pumps and vacuum tanks. Vacuum pumps also in stock. 800-909-6909. Ask for Ken or Randy. (PBM)

PORTABLE RESTROOMS

PGA Event Restrooms Available Mid-June: Save \$80 off Tufway, Maxim 3000 and Taurus Forest Green units used one week at PGA tournament in San Diego. Also used at tournament: Forest Green Freedom ADA units. Shipping extra. Call **Satellite at 800-328-3332** or your **Area Manager.** (PT6)

BUY IT - SELL IT - PLACE IT - **www.pumper.com** - AVAILABLE ANYTIME, ANYWHERE, ANY DAY

PORTABLE RESTROOMS

YOUR CHOICE - GOOD, USED PORTABLE RESTROOMS. Poly-Portables, PolyJohn, Satellite, Olympic Fiberglass. \$150-\$250. Quantity discounts. 801-621-7814 Utah. (P6)

Fair to good used portable toilets for sale. 200 units various manufacturers \$175- \$225. 518-584-1048 ask for Charles. Email cmarriott@stoneindustries.com. (P8)

PolyJohn PJ3's Evergreen units for sale. Fair to good condition, \$200 each. Swartz Creek, MI. Ph: 810-407-0315. Email g.menard@att.net (PT6)

75 PolyJohn PJ3s. Aqua & yellow. Fair condition. \$100 to \$150 each. Southern MI. Ph: 248-437-5595 Email: johnsanit@yahoo.com. (P7)

100 PolyPortables Integra units for sale. All under 3 years old. \$250 each. Call Chris or Bruce 770-439-3131. Atlanta area. (P7)

14 Polyportable Handicap Access Units, forest green with white roofs. Used for 1 event. \$1,100 each plus shipping. 920-979-7713. (PT6)

Used PolyJohn, PolyPortable tan units, plastic skids, average to excellent condition. \$225-\$325 each. Can arrange shipping. Call Bob at 1-352-796-4540. (PBM)

Over 600 PolyJohn units 1-2 years old. Starting at \$300 each. Minimum purchase of 26 units. 772-562-4604. kim@reliablepolyjohn.com. (PBM)

Two-year-old portable toilets for sale. Units are in great condition. Must sell fast. \$150.00 non-negotiable. Assorted brands and colors available. Please call 561-202-2355. (P6)

Portable Toilets: Poly constructed, molded seat, urinal, latching door. Handicap accessible units available. New and used. CCI/Brian Touey 805-896-3777. (PBM)

PORTABLE RESTROOM TANKS

Single or multiple compartment tanks. Choose mild, stainless, or galvanized steel. Capacities from 100 to 6000 gallons, any diameter. Parts and accessories to build your own and save money. 800-545-0174. www.tanksandpumps.com. (PBM)

PORTABLE RESTROOM TANKS

Portable stainless steel tank by Best Enterprises. 400 gallon sewage, 150 water. Hypro wash down system. Slides in pickup. Used as a backup. Like new. \$7,995 OBO. 971-645-1952. (P6)

PORTABLE RESTROOM TRAILERS

Portable Executive Restroom Trailer FOR SALE. 14'W x 44'L. Separate male and female sides. Male side: 3 stalls, 2 urinals, 4 sinks, 4 mirrors. Female side: 5 stalls, 4 sinks, 4 mirrors. Heated, air-conditioned. 800-245-8368. (P7)

2001 Olympic 26' Executive, womens (4) stalls and (2) sinks. Mens (1) stall, (3) urinals and (1) sink. Heat, A/C and hot water. \$23,000. Call 866-883-9538. (P6)

Restroom Trailer - Gold Series: 32', new and used. Women's - 5 stalls, 2 sinks. Men's - 2 stalls, 2 urinals, 2 sinks. CCI/Brian Touey 805-896-3777. (PBM)

2000 Olympic 30' Luxury Liner. Womens has common area with oak vanity and (3) private rooms with full size flushing toilets. Mens has common area with oak vanity, (3) urinals and (1) private room with full size flushing toilet. Both have heat, A/C and hot water. \$28,000. Call 866-883-9538. (P6)

New and used **RESTROOM TRAILERS** available immediately. 8 to 34 foot luxury trailers. Comforts of Home Services Inc. 877-382-2935. (PBM)

RESTROOM TRAILERS FOR SALE: New in 2007. Various sizes available. Ready for immediate use. 410-266-7812 or go to www.restroomtrailers.org for pictures and details. (P8)

Restroom Trailer - Platinum Series: 30', new and used. Women's - 4 stalls, 2 sinks. Men's - 2 stalls, 3 urinals, 2 sinks. CCI/Brian Touey 805-896-3777. (PBM)

PORTABLE RESTROOM TRUCKS

1996 International 4700 with a 700 US gallon, 2-compartment (500/200 split), carbon steel, portable toilet service unit. **In stock!!!** (Stock #6921V) **www.VacuumSalesInc.com, (888) VAC-UNIT (822-8648).** (PBM)

PORTABLE RESTROOM TRUCKS

2004 Isuzu NQR, 950/300 Progress tank, 2-unit carrier, \$29,000 OBO. NY. 800-275-3616. (PT7)

1993 F450 7.3 at 650W/150 WTR, under hood pump & 12V wash down. Good starter or backup truck. Ready to work. Asking \$10,500. 812-522-1143. (P7)

Dreaming of a Crescent Rectangular Vacuum Tank? And you have an existing chassis ... Crescent Tank Mfg. will up-fit or ship to you tank only. Call to get tank only quote. **Crescent Tank Mfg.** 585-657-4104; www.crescent-tank.com. (P6)

1989 Int. 6.9 diesel, 5-speed, 700/300, new rubber, A/C, dual service potty rack, nice truck. \$6,500. 609-859-3629. (P7)

6 SERVICE TRUCKS FOR SALE: 1-1997, 4-1999s, 1-2000; All Fords, Satellite tanks, great shape. Call Dave @ On Site Sanitation 651-429-3781. (PT6)

2007 F-750 Super Duty flat bed, Lely Mfg. 700/300, 40,000 miles, like new. \$60,000. Call Sam 770-231-8498. (CP8)

(1) 1999 International 4900, (1) 2000 International 4900, (2) 2001 International 4900, 6-spd. transmission, DT466, 210 hp, A/B, P/S, A/C, 2100 gallon, 1600 sewage, 500 water, steel Abernethy units, hose reels, racks, excellent condition, heavy specs, front line units. Call Bob at 1-352-796-4540. (PBM)

1995 Int. 444E diesel, 5-speed, runs great, new clutch and trans, new ss sides, 950/400. \$12,900. 1988 Int. (UD) cab over, 113,000 miles, 400/150, 6-unit hauler w/lift gate, hyd. PTO, Juroop pump system, good cond. \$7,500. 609-859-3629. (P7)

2002 International Pumper Truck: 4700 series, DT466, automatic, air brakes, 1200 gallon waste, 300 gallon fresh water, Masport 75 pump. CCI/Brian Touey 805-896-3777. (PBM)

2007 Isuzu NPR-HD (pre-emission) chassis ready to be up-fitted with **Model 800** (550/250) **Crescent Rectangular Vacuum Tank.** **REDUCE** fuel costs and **IMPROVE** productivity with the all-in-one vehicle (service & pick-up/delivery). Great price and they won't last. Call for quote today **Crescent Tank Mfg.** 585-657-4104; www.crescent-tank.com. (P6)

PORTABLE RESTROOM TRUCKS

2007 XL Super Duty F550, 42,000 miles, Satellite Industries tank 650/250, 17,900 GVW, like new. \$47,000. Call Sam 770-231-8498. (CP8)

1999 Freightliner FL60 with a 1000 waste, 250 mix, 250 water, **stainless steel**, portable toilet service unit. (Stock #2104V) **www.VacuumSalesInc.com, (888) VAC-UNIT (822-8648).** (PBM)

READY TO ROLL with SPECIAL PRICING: 1 remaining, 2007 International 4100 (pre-emissions) chassis **Model 1100** (750/350) **Crescent Rectangular Vacuum Tank.** Call for quote **Crescent Tank Mfg.** 585-657-4104; www.crescent-tank.com. (P6)

1998 International 4700 with a 1,500 US gallon, 2-compartment (1100/400 split), carbon steel, portable toilet service unit. (Stock #8734C) **www.VacuumSalesInc.com, (888) VAC-UNIT (822-8648).** (PBM)

1999 Isuzu FTR, 190 hp, 6 cyl. diesel, 25,900 GVW, new Allison auto with 2-yr. warranty, Jay's Inc. 1,300 gallon 800/500 split, National 190 cfm vac. pump, Burks DC-10 wash down pump, heated dump valve, heated bucket fill, heated water pump, 60' hose reel, 2-unit toilet carrier, and more. 123,800 miles. \$35,000. Call Dale 708-878-4391. Located in Illinois. (PBM)

(2) 2005 335 Peterbilts, none CDL, 40,000 miles, like new, auto, air, 1500 waste/500 water with pressure washer, Progress tank, 2-unit carrier. \$68,000 each. 608-835-3459. (PBM)

2006 C5500 Chevrolet, miles in 40s with aluminum and steel tanks. Still under warranty. Slide-ins 600/250, \$9,000. Portable toilet transport trailers: 8, 10, 12, 14, 16, 20 haulers. New portable toilet trucks and new and used septic trucks. We stand behind everything we sell. Lane's Vacuum Tank Inc. 1-800-592-3308. (PBM)

2007 Chevy C7500 cab & chassis with a new 1500 waste, 500 water, aluminum portable. Call for pricing. (Stock #13289) **www.VacuumSalesInc.com, (888) VAC-UNIT (822-8648).** (PBM)

2004 Ford 550, 4WD, automatic, 130K, Abernethy tank, 700 waste, 300 water, excellent condition. View @ ablerentajon@charter.net or call 877-658-0982. (P7)

PORTABLE RESTROOM TRUCKS

1990 Int. diesel, 5-speed, 700/400, potty rack, 2 tool boxes, 90,000 miles, on Jasper rebuilt. \$6,500. 1990 Ford Vactor/Jetter, Jasper rebuilt 6 cyl. diesel w/less than 500 miles, auto trans., rebuilt 2-stage fan, 1800 gal. debris, can paint your color (extra). \$24,900. 1989 Ford, 12-yr. tandem dump truck, 6 cyl. diesel, 10-speed, good cond. \$11,000. 609 859 3629. (P7)

POSITIONS AVAILABLE

Established **Industrial Cleaning Company** seeks operators & assistant/**Operations Manager.** Successful applicants need to be self motivated, hands-on, good communicator, willing to travel & learn the position throughout Arizona. Business based close to Tucson, AZ. Salary based DOE. Benefits, 401K, plus other incentives for the right applicant. Fax resume to 520-385-0557. (CMP6)

Plumbing company in Florida seeking enthusiastic class B CDL tanker endorsement licensed pump/vac truck operator. Experience preferred. Medical, 401K, holidays, vacations. 1-800-930-1123 or 954-981-2133. (CPBM)

Looking to relocate to Sunny South Florida? Are you an experienced plumber or sewer and drain professional? Then you deserve to earn \$80K/year, \$5,200 bonus and a new truck and full benefits. Please call Don at 1-800-930-1123 or 954-981-2133. (CPBM)

PUMPS-SUBMERSIBLE

Wholesaler for Hydromatic, Zoeller, Myers, Liberty and ABS pumps. We also supply Grinder pumps and basins. Will help you size them. Septic Services Inc. 800-536-5564. (CPBM)

PUMPS-VACUUM

(2) 400 cfm vacuum pumps. Juroop and Wallenstein. Mounted with gear boxes. \$2,500. 512-577-5000. (P6)

Vacuum Pumps - New, used, or rebuilt. 30 to 900 cfm. All major brands; air, water, or fan cooled. Rebuild specialists - rebuilt PB, M3, M10, and others available. 800-545-0174. www.tanksandpumps.com. (PBM)

PUMPS-VACUUM

460 Challenger pump, approx. 7 years old, clockwise rotation. \$1,000 OBO. Day 810-560-3268; Evening 734-878-5228. (PBM)

Complete line of Moro, Conde and engine-driven, stand-alone pump systems, DC10 washdown pump. Call us for any of your vacuum truck parts from shut-off valves, primary and secondary valves, hoses, vacuum pumps and drive systems. Septic Services Inc. 800-536-5564. (CPBM)

New **Masport** pumps and genuine **Masport** components. Compare our price before you buy. Free shipping. W-K Machine & Supply Co. Call 1-800-633-8947. Distributor. (PBM)

Need a vacuum pump for your portable pumper? Try our new 30 cfm, 12 volt system. Less noise, no fuel. Automatic oiling, cheaper than a gas engine. 800-545-0174. www.tanksandpumps.com. (PBM)

ROLL-OFF TRAILERS

1999 Benlee (2) Two container roll off trailer. 75,000 hoist with alum. Budds. Great condition Just painted. \$29,500. KLM Companies. Ph: 617-909-9044. (P6)

SEPTIC TRUCKS

1978 Ford cabover, 3500 gals., CAT 3208, automatic, Jurop R260. Cab shell and tank new in 1993. Asking \$18,000. Call Dick 978-276-0217. (P7)

1988 Ford LTL 9000 w/3500 gal. hyd. dump/door vacuum tank, Cat 400 hp engine, Fuller trans., air ride susp. Ready for work. \$23,950. 617-909-9044, KLM Companies. (P6)

2000 Freightliner FL80 (2 available). 4000 US gallons, carbon steel, 2-comp. (3800/200). Vacuum -pressure tank and jetting system. **In stock!!!** (Stock #5392C) www.VacuumSalesInc.com, (888) VAC-UNIT (822-8648). (PBM)

2001 Intl. DT-466, 7-spd. tandem, new 3600 gal. tank, Masport 350 cfm vacuum pump, 237,000 miles, \$49,000. 2000 Intl., DT-466, auto., new 2300 gal. tank, 350 cfm Masport pump, 147,000 miles, \$44,000. Other new & used toilet & septic trucks available. Everything we sell has warranty. Lane's Vacuum Tank Inc. 1-800-592-3308. (PBM)

SEPTIC TRUCKS

1978 International Loadstar. 8 speed with 404 gas V-8. 1000 gal. tank, newer Battioni pump and tires. 26000 GVW with hydraulic brakes. \$5000 OBO. Chris 715-395-4000. (P6)

1994 Volvo, 13-speed 400 hp Cummins diesel, 3,000 gallon tank, and a Positive Displacement Blower. \$28,000. Please email for pictures: aq@aqinc.net. Call Marvin Meyers @ 734-231-1530. (P6)

2002 Int. 4300, DT 466 diesel, low miles, 1500 gal. Abemethy tank, air brakes. Sharp, attractive truck. Non-CDL. \$46,000. 715-772-3442. Wisconsin. (P6)

1997 Mack CH600, 500K miles, new rubber, new 3300 gal. tank, Masport 75 pump, ready to go. \$62,000. 785-231-0834. (P6)

1999 International Eagle, 340 hp Cummins, 10 speed, 102,000 miles, 3600 steel tank, MORO pump, \$43,000. Call 772-473-3716 for details. (PT6C7)

1999 International 4900 series, 176K miles, 2500 gal. vac tank brand new, Masport 75 pump. \$38,900. 785-231-0834. (P6)

2005 Huber Dominator 4200 gal., hoist, HYD open rear door. Water jet system, 500' reel. Truck is 1986 Peterbilt 359 triaxle. Full frame up restoration. Absolutely immaculate, call for full specs. 978-423-7538. (P6)

1999 Peterbilt, 435 hp Cat, 13 spd., with new 3400 gallon vacuum tank, new Moro M10 pump, new paint and tires, exc. shape. \$65,000 OBO. 309-224-8772. (CP7)

2000 Sterling, 2300 gal. tank w/fresh water tank for mounted Harben jetter, 84,000 mi. \$35,000. Call Barb 715-754-2332. (P6)

1990 International septic truck. DT 230 hp engine. 2600 gal. tank. Fruitland pump. New paint and tires. Call for more info. \$16,000 neg. 1-920-743-5099. (P6)

2004 International 4300 with 2500 gal. tank, 4 heated valves, TSI 500 pump, excellent condition, 125,000 miles. \$49,900. 607-746-3003. (P6)

1997 Peterbilt Model 357, CAT 3306 motor, Fuller 8-speed trans., 4200 gal. Transway tank, 800 Transway pump, 220K miles, red. Excellent condition, ready to work. \$55,000. 978-692-3085. (PBM)

SEPTIC TRUCKS

2004 Peterbilt Model 330, CAT motor, air ride susp., fully loaded, 3600 gal. Transway tank. Truck is like new, 50K miles, red. Asking \$82,000. 978-692-3085. (PBM)

2001 Mack RD686ST heavy spec. with a 3200 gallon **stainless steel** vacuum tank, large tool boxes, NVE 466 Challenger pumps. Excellent truck; very well maintained by one operator. (Stock #7948V) www.VacuumSalesInc.com, (888) VAC-UNIT (822-8648). (PBM)

1993 Mack CH613 350HP, Mack engine with 40K air ride rear with 14K ft. axle. 3,200 gallon Marsh vacuum tank with Masport 350 CFM liquid-cooled vac pump. Ready for work. \$29,950. 617-909-9044, KLM Companies. (P6)

Need a tank and truck, any size, any make truck? Let us help you get the best deal. Custom built to your specs. For information and a price quote call 800-545-0174. www.tanksandpumps.com. (PBM)

2008 Peterbilt 340 **loaded with every option except with automatic**, with a new Presvac 3600 gal., aluminum vacuum tank unit. Masport HXL400WV pump. (4) 2009 Models coming in May/June. (Stock #13297E). www.VacuumSalesInc.com, (888) VAC-UNIT (822-8648). (PBM)

SHOWER TRAILER

Shower Trailer - Gold Series: 32', new and used. Men and women sides each have 3 private shower stalls with changing area, 1 restroom stall, 1 sink. CCU/Brian Touey 805-896-3777. (PBM)

SLIDE-IN UNITS

Start up/Back up — Complete package; '07 slide-in unit (250/200), '07 Dodge 2500 4x4. Slide-in unit has a Masport pump with a Honda electric start 5 hp engine. The '07 Dodge has a HO Cummins diesel engine with a 6-speed transmission. See pictures on website www.crescent-tank.com. **Crescent Tank Mfg.** 585-657-4104. (P6)

BEST GH300/110 STAINLESS STEEL SLIDE-IN UNIT. Honda 5.5 hp electric start engine, Conde pump. Never been used. Call Randy @ 1-800-284-1311. (PT6)

SLIDE-IN UNITS

500 gal., 350 waste, 150 fresh, Honda power, Masport pump. Ready to go! \$6,250. Delivery available. 785-231-0834. (P6)

SLUDGE APPLICATORS

1998 2505 Ag-Chem Terragator. 4,000 gal. vac/pressure tank. 260 Jurop w/final filter, 400 Cat engine w/low hours, 6-disc injection, hydraulic top hatch, great unit. \$118,000. 320-269-5441. (P6)

1987 I.M.E. Super/Jector 3500 gal. vac/pressure tank, 250 hrs. on 3208 Cat re-man. motor. Pearson PB8 vac pump, four-knife shank, tires 66x43.00/25 at about 60%. Unit in good condition. \$38,500 OBO. Day: 810-560-3268; Evening: 734-878-5228. (PBM)

2 SLUDGE APPLICATORS: Agco Terra Gator, Moro pump, 2600 hrs., 2600 gal. tank. 10-spd. trans., \$22,000; 4000 gal. tank, 10-spd. trans., Moro pump, \$12,000. Located in Ohio. Call 412-403-4027. (P8)

TANKS

1988 Presvac 3200 gallon pumper w/750 Presvac pump. Dumper, full open door, extra 750 pumps & gear boxes. Excellent condition. \$9,500 OBO. 734-365-4035. (CP7)

New 3400 gallon tank, never used, 36" manway bottom, 20" manway top, 3" intake, 4" dump, hose trays. \$10,000. Delivery available. Other tanks available. 800-721-2774 or 239-656-2774. (P6)

4000 gallon dump/vac. Full opening rear door. Manhole. Primary/intake/dump. New paint. \$12,500. 512-577-5000. (P6)

Pre-owned 3500 gallon carbon steel tank with primary and secondary full length trays, top and rear manholes. Great thickness test report. (Stock #VS102V) www.VacuumSalesInc.com, (888) VAC-UNIT (822-8648). (PBM)

New 5000 gal. tank w/primary, 2-21" manways top, 36" bottom, 4" intake, 6" discharge w/valves. Painted white. \$15,000. Delivery available. 800-721-2774 or 239-656-2774. (P6)

Used 3050 gal. vacuum tank 72"/16', primary/secondary shutoffs, hose trays, 20" top/rear manways, 3/3" site glass, 4" air valve with rebuilt DRUM S440 vac, pump 400 cfm. \$5,900 OBO. Pictures 402-371-7024. (P6)

TANKS

New Presvac 4,000 gallon, aluminum polished shell with primary shutoff, 20" top and rear cleanout, 4" intake and 6" discharge. Diamond plate hose trays with full length paint protection. (2) full baffles. (Stock #13290) www.VacuumSalesInc.com, (888) VAC-UNIT (822-8648). (PBM)

Vacuum tanks, 100 to 6000 gallons. All options available; hatches, primary, secondary, valves, catwalks, ladders, etc. Every-thing needed to build your own septic truck. Choose mild, stainless, or galvanized steel. Ask about full open doors. 800-545-0174. www.tanksandpumps.com. (PBM)

TANK TRAILER

2008 new Acro trailer, 7,000 gallon double conical, 12" drop to center, aluminum trailer. On our lot and ready to go. (Stock #13273B) www.VacuumSalesInc.com, (888) VAC-UNIT (822-8648). (PBM)

1990 Presvac 5000 gallon **stainless steel**, DOT certified vacuum tank trailer with a PV750 pumpo and Deutz diesel engine package. Mirror type polish finish. (Stock #5008V) www.VacuumSalesInc.com, (888) VAC-UNIT (822-8648). (PBM)

2000 Pioneer 6300 gallon, carbon steel, vacuum tank trailer with primary & secondary. Hose trays on both sides and a hutch suspension. Nice trailer. (Stock #0224V) www.VacuumSalesInc.com, (888) VAC-UNIT (822-8648). (PBM)

2008 New Presvac 5,500 gallon, carbon steel, DOT 412, vacuum tank trailer with a PVB750 and Deutz diesel engine package. In production for May! (Stock #13325) www.VacuumSalesInc.com, (888) VAC-UNIT (822-8648). (PBM)

TOOLS

T&T Tools: Probes, Hooks. Probes feature steel shafts with threaded and hardened tips. The insulated **Mighty Probe™** tested to 50,000 volts. **Top Poppers™** open manhole covers easily. Free catalog. www.TandTools.com. Phone 800-521-6893. (CPBM)

Crust Busters - Portable, lightweight machine guaranteed to mix up septic tanks and grease traps! Save time and money! www.crustbusters.com, 1-888-878-2296. (PBM)

NEED SOFTWARE?



The Leading QuickBooks® add-on Software for today's Portable Sanitation Business.

- Interface with QuickBooks® -The Service Program generates your recurring route billing and seamlessly allows you to print the invoices in QuickBooks®
- Easily Manage Routes
- Competitive Upgrades Available - Receive a Discount to Convert Off Your Existing System
- Palm and Windows PDA Handheld Support w/Remote Sync
- Track Pick-Ups & Drop-Offs
- Works with Mapquest® and Mappoint®
- Track Inventory at Multiple Locations
- 30-Day Money Back Guarantee-Leasing Available
- 30 Day No Risk FREE Trial with Weekly Training

866.480.1879
www.theserviceprogram.com



"Duel Power Lid"

Plugs, Lids & Adaptor Rings

Sizes Available: **18", 24",
30" & 36"**

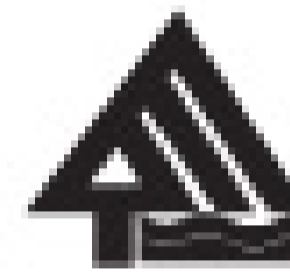

Fergus Power Products
Providing "Environmental Products"

The Company who maintains a pulse on the environment!

Toll Free **1-800-243-7584**
E-mail **fproducts@prtcl.com**

TRUCK TOWN

2601 East Hwy. 80 • Abilene, Texas 79601

FULL SERVICE VACUUM SYSTEMS SUPPLIER

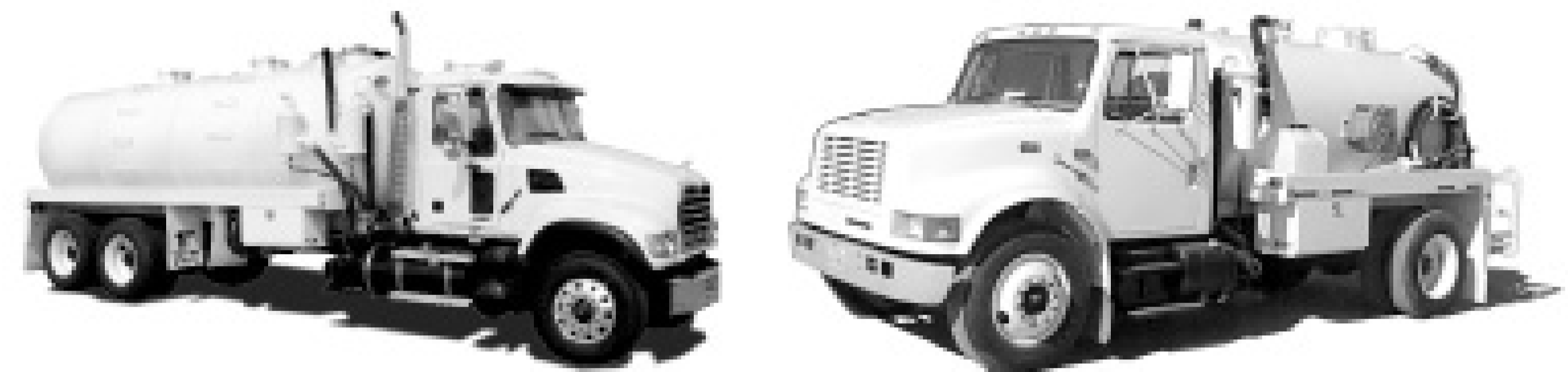

1-800-727-0350

**GOOD ASSORTMENT OF CUSTOM SPEC TRUCKS
FOR YOUR VACUUM UNIT NEEDS**

LELY SEPTIC & OIL FIELD VACUUM TRUCKS
TROXELL TRAILERS



JEFF MULLICAN • HUBERT YOUNG • DENNIS ADAMS

Phone: 325-673-4642 • Fax: 325-673-4673
Web Site: www.truck-town.com • E-mail: truck@camalott.com

TOYS

Septic pumper and vacuum die-cast toy trucks in your choice of colors and logos. Several cabs available. Call 877-450-2100 or write to Granite State Collectibles, PO Box 440, New Ipswich, NH 03071.

(PBM)

TRAILERS VACUUM/TANKER

1986 Presvac 5,000 gallon 316 stainless steel MC 307/312 vacuum trailer with hyd. vacuum pump drive. Spring suspension. In excellent condition. Must see. KLM Companies 617-909-9044.

(P6)

1980 Presvac 6,000 gallon trailer. \$10,000 OBO. 973-663-2400 Mike.

(P6)

We have 4 vacuum trailers: (2) 5000; (1) 5500; (1) 6500 gallons, in great shape and ready to work. Great for septic, nonhaz or nonrcra waste. Also have (3) 2000 Freightliners with Fruitland pumps. Call James 661-816-4646.

(P6)

1993 Presvac 6,000 gallon DOT certified carbon steel vacuum trailer. Self-contained Deutz diesel engine with PV750 vacuum pump. Very good condition. \$38,500. KLM Companies 617-909-9044.

(P6)

TRUCKS/ DELIVERY

1985 Mack DM600, 6-spd, cab replaced, 4000 gallon tank, 3 valves, Moro A-C4 pump, 1-15,000 lb. Bethlehem Mfg. mountrail bed, 18' bed, 10' boom, double post on back. 252-491-2321.

(P6)

TV INSPECTION

1998 Cues TV grout unit, 34,880 miles, color camera, diesel, generator. 972-938-1905. www.empireequip.com.

(CPBM)

Pearpoint P-147 EXPLOSION PROOF system, P-299 hydraulic cable drum, Pearpoint hexiprobe coiler, P-225 power supply, VHS, color video printer, 2 tractors, 3 cameras, Kubota diesel genset, wash down system, more spare parts, wheels etc., than you can imagine, 95 E-350 extended van w/7.3 Powerstroke, 48,000 miles, turtle-top, roof air, perfect van. \$49,950. Pictures and more info on our website: letsrollautoandequipment.net under (vans light duty). (Colorado) Call Ned 719-338-3767.

(CP7)

VACUUM LOADERS

2000 Sterling with Cusco Mastervac 3,800 CFM 3,000 gallon DOT certified vacuum loader. Wet/dry unit with full open rear door and Moro vacuum offloading pump. Low miles/hours. Ready for work. KLM Companies 617-909-9044.

(P6)

1992 Ford with Guzzler 4816 with swing out Cyclone 6,000 CFM blower (4 yrs old). Cat engine with Fuller trans. 150,000 miles, 5,000 hours. Runs very good. \$25,500. KLM Companies 617-909-9044.

(P6)

1997 Peterbilt 379 heavy spec with a 3200 gallon, carbon steel, DOT certified, **Cusco master vac** wet/dry industrial vacuum loader with dual baghouse, PD blower, rotary vane vacuum pump. Full open rear door dump unit. Very clean. (Stock #1499V) www.VacuumSalesInc.com, (888) **VAC-UNIT (822-8648)**.

(PBM)

2009 Sterling LT9500 tri-axle with a new Presvac, **Powervac** 3800, 3,250 gallon US, DOT, wet/dry industrial, vacuum tank loader. (Stock #13336V) www.VacuumSalesInc.com, (888) **VAC-UNIT (822-8648)**.

(PBM)

VACUUM LOADERS

27' vacuum loaders, hazardous hydrovacs, reg. vacs. 780-433-1467; www.hydrovacsunlimited.com.

(CP7)

1999 International **heavy spec** with **Guzzler ace** wet/dry industrial vacuum loader. 8' top load boom truck is in excellent condition. Blower was reconditioned approximately one year ago. (Stock #7390V) www.VacuumSalesInc.com, (888) **VAC-UNIT (822-8648)**.

(PBM)

VANES

Dura Comp 535, high-quality non asbestos vacuum pump vanes. Good to 400°F. Buy factory direct and save. Same day shipment on most models. Jurop, Battioni, Moro, Masport, Fruitland, Demag. Long lasting Dura-Comp 535 pump vanes carry a "Money-back" guarantee. Call us today. Powerflo Products 800-758-4788 or 562-997-0720.

(PBM)

American Industrial Components: Our vanes are manufactured from the highest quality laminated materials available and are fabricated to exact tolerances and specifications. 800-272-7557.

(PBM)

WANTED

WANTED: Vacuum tanks, 2200 gallon up to 5000 gallon. Cash paid. No junk, please. Ph. 903-278-0026 or 870-773-5800.

(P6)

Water jetting equipment. We rent, sell and repair water blasters. Visit us at: www.waterjettingequipment.com or phone 714-259-7700.

(CPBM)

WATERBLASTING

2003 NLB 10-150 electric waterblaster, (0) hours on unit - never used. Marathon Motor on skid. If you want brand new this is it. Priced to sell @ \$32,500. KLM Companies, 617-909-9044.

(P6)

Wanted to Buy: Vactor 2100s and late model Guzzlers. Cash. Phone 800-336-4369.

(CPBM)

NLB 10-250 2000 model year with 1,200 hrs., 250 hp @ 43 gpm. Complete mounted on 1993 International truck with 120,000 miles. Fluid/power end. Just completely serviced. In good shape. \$45,000. KLM Companies, 617-909-9044.

(P6)

Marketplace Advertising

Kwikk-Lokk

Vacuum Truck
Couplers and Hose.

www.kwikk-lokk.com
(814) 899-3644

Mobile Dewatering Service

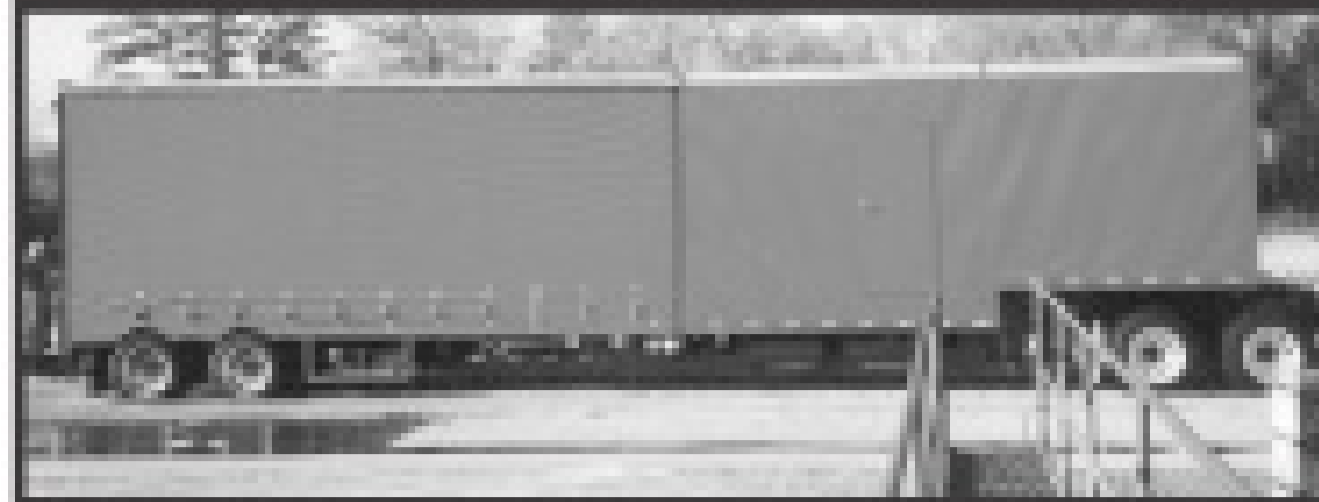

Municipal & Industrial Sludge
Digesters, Lagoons,
Ponds, etc.

- Double Belt Filter Press
- Up to 25% Drier Cake
- Professionally Staffed
- US & Canada

Fluid Technology, Inc.

P.O. Box 937, Oxford, OH 45056
Phone: 513-981-7808
E-mail: sales@fluidtechinc.net
Web site: www.fluidtechinc.net

Major Credit Cards Accepted!



\$35
PER
DOZEN
\$189
FOR 6
DOZEN

- 14" Gauntlet
- Plastic Coated
- Jersey Liner
- Sandpaper Finish Grip
- One Size Fits All

Make checks payable to:
ADVANCE GLOVE CO.
These include UPS shipping address

ADVANCE GLOVE CO.
EO. BOX 149 • LENOX, MI 48849
TOLL-FREE: **1-800-323-1223**

WWW.ROOTERMAN.COM



Franchises available with low, flat fee
New concept. Call 1-800-700-8062.

FRANCHISE PACKAGE \$7,950.

WATER JETS FOR RENT



- Units from 4,000 to 40,000 psi, including convertibles
- 60-600 hp, diesel or electric
- Rent, buy or lease
- Branches in MI, TX, NJ, CA, LA

NLB Corp. 1-877-NLB-7996
www.nlbcorp.com

Complete Jetter Package

Plumbers - Let us improve
your bottom line



13HP
4000 PSI **\$1,499**
Free Freight

COMPLETE DETAILS AT
www.amazingmachinery.com

1-800-504-7435

"You're going to WORK,
not WAR!"

ARE YOU STILL USING
A HOOK OR PICK AXE
TO REMOVE SEPTIC TANK COVERS?
NOW THERE IS A BETTER WAY!



Call for a **FREE 30 Day Trial**

phone: 866.926.5438
fax: 866.271.9057
email: info@BigsEasyLift.com
www.BigsEasyLift.com

BIGS
EASY LIFT

Eliminate back injuries with BigsEasyLift

Aluminum Vacuum Tanks

ALUMATANK

progress.tank.com

PORTAVAC

Septic & Restroom
Service

Waterblaster Rentals

Houston, Texas



Boatman Industries

1K to 50K psi
60 hp to 1000 hp
Waterblasters & Accessories
Used Equipment Sales

713-641-6006
www.boatmanind.com

T&T TOOLS **T&T Tools**
800-521-6893

800-521-3260 FAX

E-mail sales@tandttools.com • www.tandttools.com

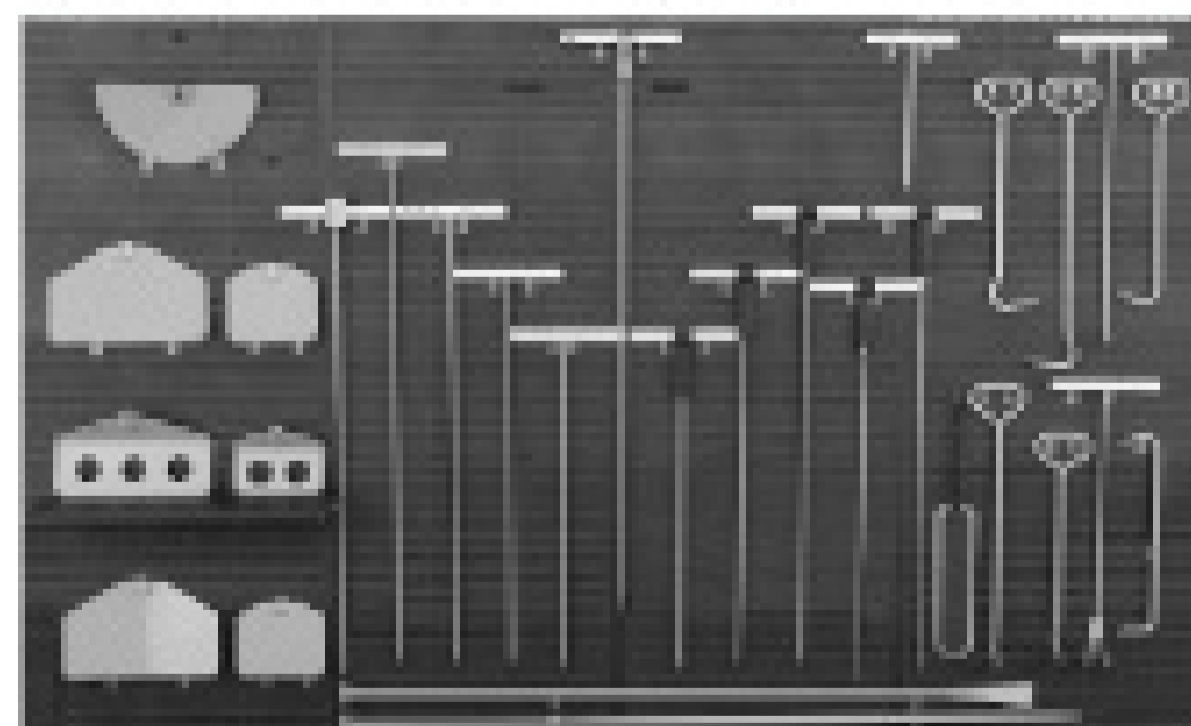

Mighty Probe™
Sludge Hoe™
(insulated)
Sludge Spud™
Manhole Hook
Tommy Hook™
Striking Head™

Handy Hook™
Water Probe
Curved Spud™
Top Popper™
Ground Buster™
Smart Stick™
(standard)

www.tandttools.com

PADLOCKS

- Your Padlocks
- Your Key Number
- Any Quantity
- Best Prices

**Quick-Shipped
Anywhere!**

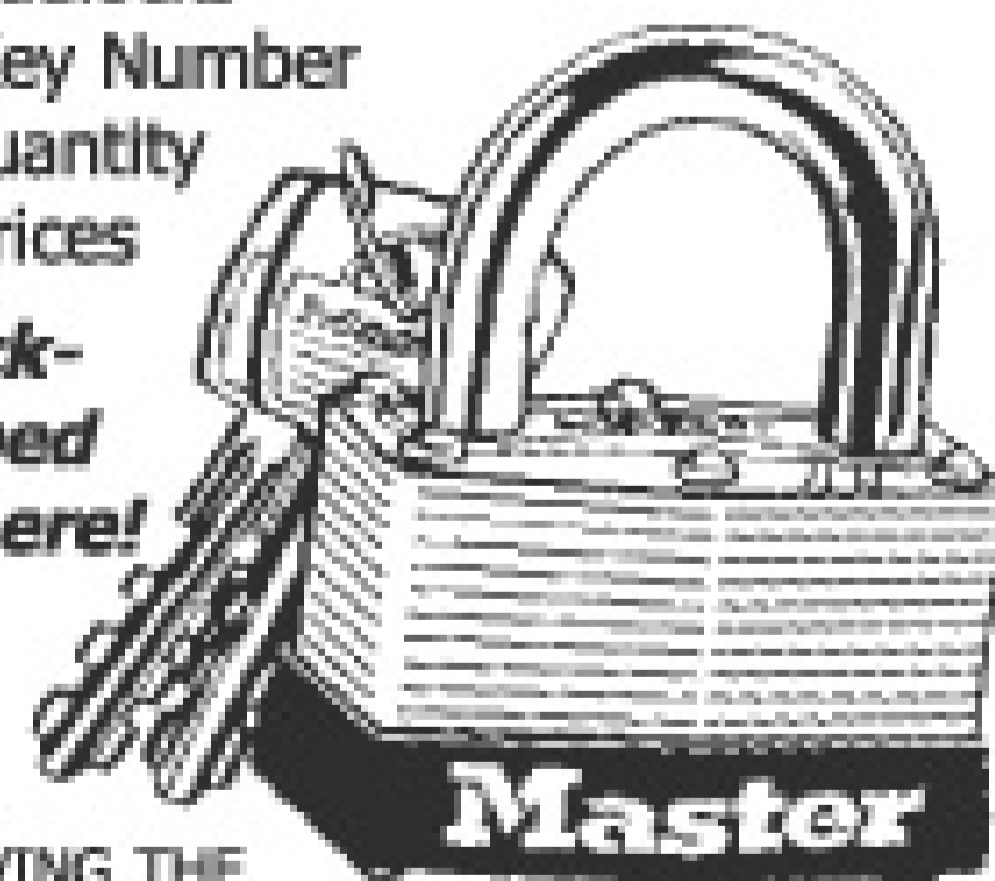

SEMPER PARANS
PORTABLE SANITATION
INDUSTRY FOR
14 YEARS—
WE'RE THE
BETTER WAY
TO BUY PADLOCKS™

Call For **FREE**
CATALOG
or **Instant**
Quote!

LockMasters
1-800-461-0620
www.lockmastersusa.com

sales@lockmastersusa.com • Fax (850) 914-9754

EASILY MOVE RESTROOMS

- ✓ Aluminum Frame
- ✓ Ships UPS
- ✓ Carry ADA's
- ✓ Models starting at \$380



Available with 2, 4, 6 or even
8 wheels and your choice of
air or solid foam tires.

Super Mongo Mover®

DA
Deal Assoc. Inc.

www.dealassoc.com

866.599.3325

PRO™

PORTABLE RESTROOM OPERATOR



For companies that rent and service
portable restrooms, restroom trailers,
drop boxes and other equipment for
construction sites and special events.

Subscribe today!
It's FREE.

Call: **1.800.257.7222**

PIT HOG PUMPS WASTE

LWT manufactures manned and remote controlled lagoon dredges and pumps. Rental dredges also available.



LWT LIQUID WASTE TECHNOLOGY.

1750 Madison Ave., New Richmond, WI 54017
www.lwrtpithog.com / 1-800-243-1406

SEPTIC ODOR PROBLEM?
ODORHOG™ Charcoal Activated Vent Pipe Filters Remove Sewer & Septic Odors from Plumbing Vents



Patent Pending

ODORHOG™ Filters Come in 5 Standard Sizes or Any Custom Size You Specify
SAME DAY SHIPPING & PRIVATE LABELING AVAILABLE

A&M BIO-FILTER, LP
1.800.963.6746
www.odorhog.com

30% OFF FOR ALL ORDERS OVER \$2000



ASHLAND PolyTraps

Grease, Oil, Hair and Lint Traps and Interceptors

- NO Rust or Corrosion
- Lightweight
- Very Cost Effective
- Sizes up to 560 Gallons
- Made in the U.S.A.!

LIFETIME WARRANTY!

Certified by U.P.C., IAPMO and P.D.I.

800-541-8004

PolyTraps@Amplex.net
www.ashlandpolytrap.com

LEASING SOLUTIONS



If you have special or unique needs, for straight answers and a quick response, call Jim Thomas.

Conserve your working capital. Keep existing credit lines intact, and enjoy the security of knowing financing is there when you need it. We offer loan and leasing plans tailored to individual needs.

- Portable Toilets
 - Sewer Equipment
 - Pumper Trucks
 - TV Inspection
 - Water Jetters
 - New and Used Equipment
 - Vacuum Trucks
- Programs offer longer terms for older equipment.
- We do start ups.
- 90 Day Delayed Billing.
- Seasonal Payment Programs Available

Get Pre-Approved for the Pumper & Cleaner Environmental Expo

Prompt, no nonsense financing designed to meet individual requirements. Payment plans that are generally lower than other finance plans. With years of experience, we understand the competitive nature of your business. We're prepared to act quickly and decisively!

Toll-Free 877-333-4539 • www.keycommercial.com



TrakMats™
Ground Cover Mats

- * Tough, Lightweight
- * Cleats for traction
- * Light color prevents burnt grass
- * Hand cutouts for lifting



800-762-8267
SVE Sales, Inc. www.trakmats.com
Charlotte, NC 28216 email: sales@trakmats.com

DISCOUNT ALUMINUM

SHEET, COIL, PLATE

3003/5052/
5454/5083/5086
AND MORE

20 MILLION POUND INVENTORY

ARE YOU PAYING TOO MUCH?

1-888-540-0066
ASK FOR JAYSON

FAX:
440-286-2229

E-MAIL:
captaluminum@msn.com

Come In We're OPEN

www.pumper.com

Coagulants and Flocculants
for Septic, Grease, Municipalities and Industry

Celebrating 30 YEARS in business

- Dewatering polymers for all dewatering equipment
- All forms: Dry and Emulsion
- Variety of packaging sizes to meet customer needs
- Both East & West coast shipping points
- Expert technical staff
- Specific solutions for our customers

Save Money
Save Time
Save Polymer

Call Toll-free: 877.771.6041



Aqua Ben Corporation
1390 N. Manzanita St. • Orange, CA 92867
www.aquaben.com • sales@aquaben.com

One Complete Package

pumper.com
promonthly.com
mswmag.com
cleaner.com
onsiteinstaller.com

constructionguide.net
pumpershow.com
pumpertrader.com
septicyellowpages.com
sewerpages.com

Cole Publishing
1.800.257.7222 • 715.546.3346

Training & Education

By **Scottie Dayton**

National Association of Wastewater Transporters Inc.

NAWT has scheduled these training sessions:

- June 5 – Inspector Training and Certification, Flagstaff, Ariz. Contact Kitt Farrell-Poe at 928/782-3836; kittfp@ag.arizona.edu.
- July 17-18 – Operation and Maintenance Training, northern California; Call 707/579-4882; www.cowa.org,
- Aug. 6-7 – Operation and Maintenance Training, central California; Call 707/579-4882; www.cowa.org,
- Aug. 26-27 – Inspector Training and Certification, Tucson, Ariz. Contact Kitt Farrell-Poe at 928/782-3836; kittfp@ag.arizona.edu.

Alabama

Licensing classes are the joint effort of the Alabama Onsite Wastewater Association and University of West Alabama. Courses are at UWA's Livingston campus unless stated otherwise:

- June 11-13 – Basic Installer
- June 26-27 – Continuing Education, Dothan
- Aug. 7-8 – Continuing Education

Call Allen Tartt at 205/652-3803 or visit www.aowatc.uwa.edu.

California

Certification courses are sponsored by the California Onsite Wastewater Association and NAWT. Check the Web site for locations.

- June 12 – Soils
- July 17-18 – Operation and Maintenance, Part 1
- Aug. 6-7 – Operation and Maintenance, Part 2

Call Cliff Trammel at 707/579-4882 or visit www.cowa.org.

Florida

Courses are at the Florida Onsite Wastewater Association's Training Center in Polk City unless stated otherwise.

- June 10 – Management of Decentralized Systems, Jacksonville
- June 11 – Management of Decentralized Systems, Daytona Beach
- June 16-17 – Master III-Basic Florida Soils
- June 18-19 – Master I-System Design and Function
- June 19-20 – Master II-System Materials and Regulation Requirement
- July 8 – Master IV-Design Considerations and Dosing Systems, Jacksonville
- July 9 – Master IV-Design Considerations and Dosing Systems, Tallahassee
- July 15 – Septage and Grease in Florida, Sarasota
- Aug. 7 – Enhanced Nutrient Reduction, Southeast Florida (TBD)
- Aug. 18-19 – Master III-Basic Florida Soils
- Aug. 20-21 – Master I-System Design and Function
- Aug. 21-22 – Master II-System Materials and Regulation Requirement
- Aug. 25 – Aerobic Treatment Units, Part I
- Aug. 26 – Aerobic Treatment Units, Part II
- Aug. 27 – Artificial Media Treatment Technologies
- Aug. 28 – Natural Media Treatment Technologies
- Aug. 29 – What's New at the Training Center?

Contact FOWA at 407/830-4381 or www.fowaonsite.com.

Iowa

The Iowa Onsite Wastewater Training Center has the following courses:

- June 19 – Basic Soils, (TBD)
- Aug. 21 – At-Grade and Mounts, Ankeny

Call Annette Adams at 800/362-2127, ext. 6464 or e-mail Dennis Hayworth at dahayworth@dmacc.edu.

Michigan

The Michigan Onsite Wastewater Training and Education Center at MSU Tollgate Center in Novi is offering these courses:

- Aug. 12-13 – Existing Systems Evaluator Training
- Aug. 20 – Pumped Systems Evaluator Training

Contact Barb DeLong at 517/355-4720 or visit www.egr.msu.edu/age, then Extension & Outreach.

Minnesota

The University of Minnesota Extension has these hands-on workshops:

- June 2-4 – Designing Onsite Systems, Mankato
- June 5-6 – Soils, Mankato
- June 10-11 – Soils, Sartell
- June 12-13 – Inspecting Onsite Systems, Waseco
- June 20 – Soils-Continuing Education, Sartell
- June 26 – Soils-Continuing Education, North Branch

Call 800/322-8642 (612/625-9797) or visit www.extension.umn.edu.

Missouri

The Department of Health and Senior Services is offering the following training professional CEU courses:

- June 17-18 – Operation and Maintenance, Hannibal
- June 24-25 – Operation and Maintenance, St. Louis

Call 573/526-6095 or visit www.dhss.mo.gov/Onsite

North Carolina

North Carolina Soils and On-Site Wastewater Training Academy is offering the following courses:

- June 10-12 – Subsurface Wastewater Operator Training, Fletcher
- June 25 – Soil Survey in the 21st Century, Raleigh
- June 26 – Installation of Pump Systems, New Bern
- June 27 – Installation of Advanced Systems, New Bern
- July 16 – Installation of Pump Systems, Williamston
- July 17 – Installation of Advanced Systems, Williamston
- July 18 – Installer/Inspector Exam, Williamston

Call Joni Tanner at 919/515-1678 or visit www.soil.ncsu.edu/training.

Pennsylvania

The Pennsylvania Septage Management Association offers the following training:

- July 16-17 – Advanced Onlot Wastewater Treatment System Inspection, Chester County
- July 16-17 – Basic Onlot Wastewater Treatment System Inspection, Bordentown

New Jersey Septage Management Association members qualify for PSMA member tuition fees. Call Jackie at 610/350-0590, press 3, or visit <http://psma.net>.

Rhode Island

The University of Rhode Island Onsite Wastewater Training Center offers these professional development workshops at its Kingston campus:

Aug. 22-23

Wisconsin Liquid Waste Carriers Association Summer Convention, Radisson Paper Valley Hotel, Appleton. Call 608/255-2770 or visit www.wlwca.com.

Sept. 10-11

The National Association of Wastewater Transporters Inc. Septage/Grease Trap Waste Treatment Symposium, Holiday Inn at Six Flags, Eureka, Mo. Call 800/236-6298 or visit www.nawt.org.

Oct. 12-14

Virginia Onsite Wastewater Recycling Association Conference and Trade Show, Blacksburg. Call Trapper Davis at 804/966-9190 or visit www.vowra.org.

Oct. 14-15

Delaware Onsite Wastewater Recycling Association Conference and Exhibition, Dover Downs Hotel and Casino, Dover. Call 302/739-9331 or visit www.dowra.org.

Oct. 23-26

Ontario Association of Sewage Industry Services Conference and Exposition, Best Western Conference Centre, Orillia. Call Don Kelloway at 877/202-0082 or visit www.oasisontario.on.ca.

Nov. 5-9

Portable Sanitation Association International Convention & Trade Show, Hilton Hotel Ocean Beach and Ocean Center Exhibit Hall, Daytona Beach, Fla. Call 800/822-3020 or visit www.psai.org.

Jan. 13-15, 2009

Michigan Onsite Wastewater Conference, Kellogg Hotel and Conference Center, East Lansing. Many sessions count for required CEU hours. Call Mark Scott at 989/275-5011 or e-mail mScott@i2k.com.

Jan. 30-31

Wisconsin Liquid Waste Carriers Association and Wisconsin Onsite Water Recycling Association Joint Convention, Marriott West Hotel, Madison. Call 608/255-2770 or visit www.wowra.com.

- June 4-5 – Innovative and Alternative Systems Operation and Maintenance
- June 18 – Soils Basics for the Onsite Wastewater Contractor
- June 25 – Bottomless Sand Filter Design and Installation
- July 10 – Innovative and Alternative Systems Field Tour
- July 15 – Surveying Techniques for the Wastewater Professional
- July 17 – Microbiology for Wastewater Professionals
- July 30-31 – Advanced Soil Morphology: Understanding wet soil conditions
- Aug. 7 – Surveying Basics for the Onsite Wastewater Contractor
Call Holly Meehan at 401/874-5950 or visit www.uri.edu/ce/wq.

Virginia

The following courses by the Virginia Center for Onsite Wastewater Training (VCOWT) and Southside Virginia Community College are in Blackstone. Those labeled VOWRA are through the Virginia Onsite Wastewater Recycling Association.

- June 4 – A to Z of Onsite Wastewater, Charlottesville (VOWRA)
- June 18-19 – Wastewater 101
- July 16-17 – Effluent Dispersal Systems
- July 23-24 – Basic Installation Practices for Conventional/Pump OWTS
- Aug. 5-6 – National Operations & Management Training
- Aug. 12-13 – Designing with Easy/Fast CAD

For VCOWT classes, contact Debbie Campbell at 434/736-2011 or visit www.southside.edu/programs/wastetreat. For VOWRA courses, contact Trapper Davis at 804/966-9190 or visit www.vowra.org.

Association News

Virginia Starts Online Bulletin Board

The Virginia Onsite Wastewater Recycling Association Community Bulletin Board System is now online. The need for a discussion forum became critical during last year's legislative session, when e-mail distribution lists failed to keep members abreast of what was happening. Access the bulletin board from www.vowra.org.

**DELAWARE
Change in Leadership**

Ken Walsh and Jim Williams are president and vice president of the Delaware Onsite Wastewater Recycling Association through 2009. Walsh (302/436-8822) owns Multi Koastal in Ocean View and has more than 20 years of experience in the wastewater industry. Williams (302/492-3915) is a service manager and salesman for Freemire & Associates and has more than 15 years of experience in the industry.

**WISCONSIN
Group Disputes Septic-Related
Death Numbers**

Deputy Fire Chief John Andersen with the Chippewa Fire District stated in Wisconsin newspapers that eight to 12 residents die in septic tanks each year. Members of the Wisconsin Onsite Water Recycling Association believe the actual number is much lower.

Andersen's quote was part of a news report about an 82-year-old man who, while doing repairs on his septic tank, fell head first down the riser and drowned. The trade association asked area media to follow up and review the statistic and stress septic tank safety.

Board member Bill Bergh did a follow-up interview with the newspaper, advising people to keep the tank covers locked and encourag-

ing them to let licensed professionals do maintenance. WOWRA offers brochures on how to maintain onsite systems and advising people never to enter a septic tank. Call 608/256-7757 for more information.

**ONTARIO
Farmers Won't Kill Their Livelihood**

The spring newsletter of the Ontario Association of Sewage Industry Services reports that the province has established the Nutrient Management Science-based Standards Committee to develop nutrient standards for farms. The committee was formed after complaints to a township resulted in a resolution seeking support to change the regulatory framework for land-applying biosolids.

The Ministry of the Environment administers land application, tests soil to recommend the quantity to use, and monitors nutrient loads. Farmers must follow strict guidelines to apply biosolids. Citizen groups claim biosolids are contaminating their wells, making them and their animals ill, creating odors and harming soil to the point where earthworms are dying. No-till farmers who land-apply say their earthworms are thriving, and scientific evidence has yet to substantiate any of the accusations. ■

Pumper

see photos in COLOR at www.pumper.com

TRUCK STOP



June



2000 KW: Cat C12, 445 hp, 8LL trans., Chandler susp., Lely 3400 gal. full rear opening, F&R valves, jetter, DeMag Wittig pump, 172,000 miles. Clean, garaged & waxed. Owner driver.\$75,000
336-570-0729
Graham, NC P7



1994 Ford F-800: 2200 gallon tank, 200 hp Cummins motor, strong running truck.\$17,000 OBO
 Must sell - taking offers. North East Ohio.
440-998-7448 P6



1993 KW T600: 2800 gallon LMT tank with Jurop pump. Truck has all new rear tires. Tank just painted.
Call 641-673-9377
or 641-660-6991 P6M



2007 Intl. Vector 2112: 330 hp automatic, 1300 gal. tanks, 12-yd. debris, 4,000 miles almost new. 824 Roots blower, 2500 psi, 80 gpm water pump.
Call Javier 786-402-3092 P6



2005 Peterbilt "Juggler": 500 cfm blower, reel for hose, truck has 50,000 miles, AC, 10-spd. Located in Qc, Canada.\$145,000 Cdn.
819-827-2772 or
m.gascon@videotron.ca P6



1994 Vector GMC White Cabover: Cummins 6 cylinder x2, 1,000 gallons, 5 yards, dual fans, excellent condition.\$70,000 OBO
Contact Bill at 1-866-744-9921 CP6



1986 Floater: 3000 hours, 4 shank injector, 250 hp Cat engine, automatic transmission, 3,000 gal. tank\$22,000 OBO
574-848-7704 P6



2002 Ford E450 Video Inspection Van: 16' cube, 7.3L V8 turbo diesel, 101,500 mi., new tires, very well maintained. RST equip., 1,821 hrs. on computer, 5,749 hrs. on Onan Quiet diesel 8000 generator, OmniEye II & OmniEye II Zoom cameras w/mainline tractor. Computer: Windows XP Pro, WinCan 7 w/NASSCO Optibase MPEG. Ready to work.....\$62,500
909-422-8990 P6C7



1987 International: Diesel w/Myers high pressure power jet, 45 gpm pump, 1200 gal. fresh water holding tank, 1-1/4" hose x 500', single rear axle, 2-stage trans.\$16,500 OBO
1-866-352-6870 P6



1995 Mack Septic/Great Pump Truck: 5-spd. trans., 3,200 gal. tank, new Demag/Wittig vac pump truck. Looks and runs excellent.Asking \$35,500
561-753-3446 P6



2006 International 4300: DT 466, Allison 2500 auto. trans, air brakes, Abernethy steel tank, 1100 gal. waste/400 gal. water, Masport HXL 75-V pump, 2-toilet carrier, 70,000 miles, great truck!.....\$56,000
757-438-6858 P6



Shower and Restroom Trailers: Platinum and Gold Series, new and used available. Each with separate men and women sides.
CCI/Brian Touey 805-896-3777 P6M



1997 Ford: 58,000 original miles, easy on fuel, like new inside & out, new Engels 4000 gal. barrel, new Jurop LC420 pump, 36" rear manway, twin ram hoists.\$62,500
Dave 763-441-5251 or 763-427-8333 P6



2000 Kenworth T800: C12, 9-spd., 55,000 miles, c/w 2800 gal. stainless steel Presvac, Hibon 5250 cfm, 27" hg., 8 in. boom, DOT certified, Jurop pump off, ready to work, very clean unit.\$154,900 Cnd.
780-433-1467 P8



1990 Peterbilt: 425 hp Cat, 9-spd., new 3500 gal. tank and Jurop R260 364 cfm vac pump, new paint and tires.\$49,000
877-898-5104
hullstruckbodies.com P6



1996 4700 International: Diesel, auto., air brakes, storage, gooseneck. Removable 2006 1500 gal. vac. tank, Jurop pump, electric start, 21' manways on 2006 Kraftman gooseneck trailer, air brakes.\$28,000
423-400-9543 P6

Pumper TRUCK STOP

see photos in COLOR at www.pumper.com



June



1996 Volvo Vacuum Truck: M-11 Cummins 330 hp, 9-spd. trans., air ride, 3300 gal. tank w/Masport 360 cfm water cooled pump, 413K miles.....\$28,000
570-784-6093 P7



2004 Aquatech B10 Sewer Clean: Roots 824 blower, General 2000/80 water pump, multi-flow system, Sterling chassis, 300 hp, C-7, 8-spd.\$140,000 OBO
Call Javier 786-402-3092 P6



2ND AD! PRICE REDUCED \$10K! 1996 Ford L8000: 375 hp Cummins, Super 10-spd., 4200 gal. tank, 200 fresh water, 91,000 actual miles, runs and drives like new.....\$62,500
763-441-5251; 763-427-8333 P6



2003 Freightliner FL70: New 2500 gal. vacuum body, 400 cfm Masport vacuum pump.....\$41,000
Call Terry 734-777-0390 P6



1994 KW T-600: 300 hp Cummins, 180K, 2500 gal. tank, large storage compartments, tires 75%, 200 gal. fresh water tank, 6" heated dump valve, stainless steel hose trays, great truck!!.....\$36,000
320-269-2920 CP6



2005 F550 4X4 Diesel: 6-spd., XL package, H2 Masport pump, 950 gal. tank, 600 waste, 200 chemical, 150 fresh, 2-place toilet rack, 75,000 miles.....\$37,500
Call Ryan at 801-430-7287 P6



1986 International \$2600: 300 hp Cummins diesel, 8-spd., front tires 425/65F-22.5, rear tires 11R22.5, 4000 gal. Coleman w/fiberglass decks, skirts & cabinets, 300 cfm vac/pressure pump. Good condition.....\$16,500
Call Judge Coleman 516-398-5638 P6

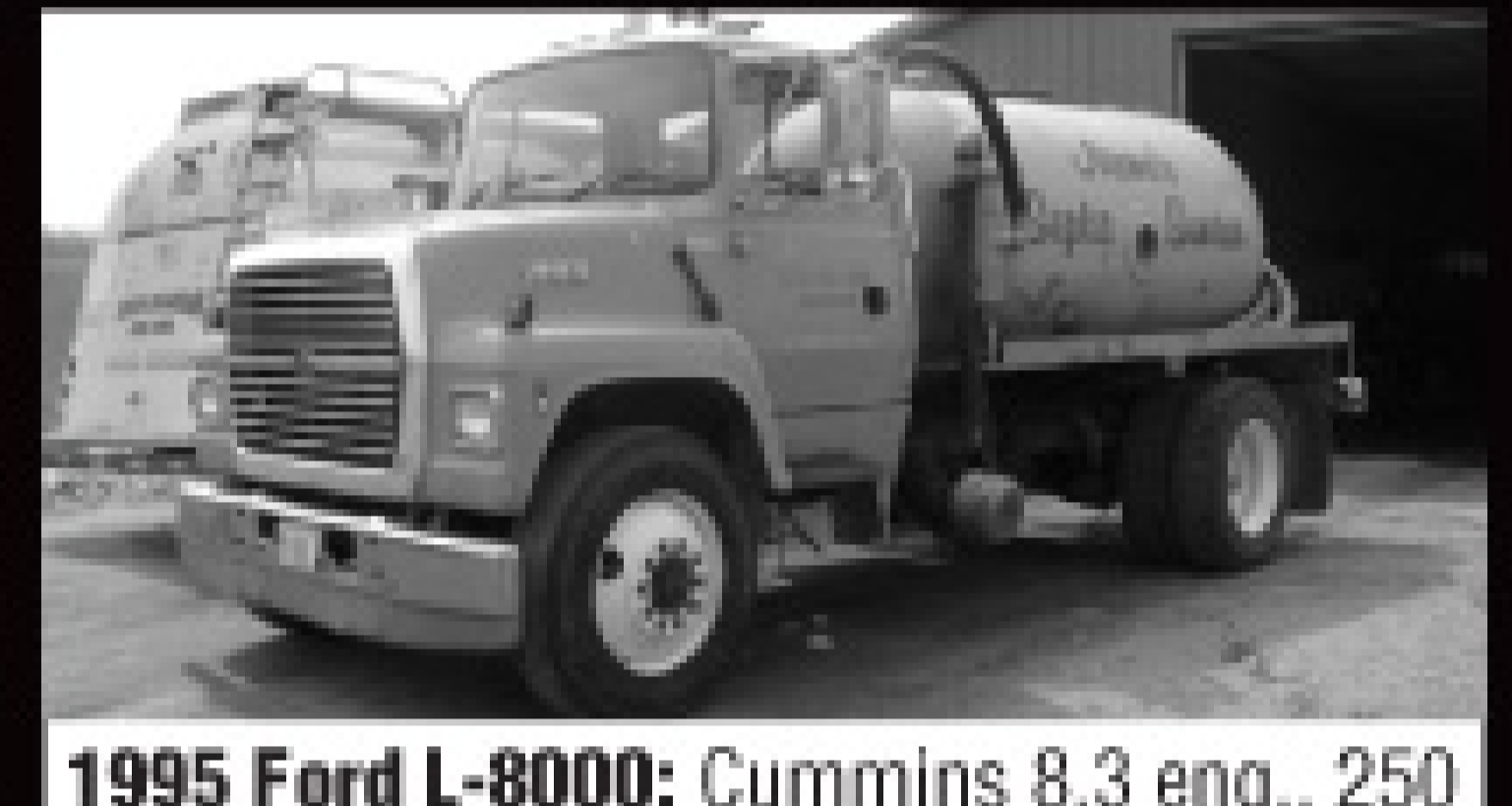

1995 Ford L-8000: Cummins 8.3 eng., 250 hp, 6-spd. Eaton trans, only 166,000 miles, 1800 gal. tank w/AC-4 pump, 100' hose. Truck kept inside and well maintained.\$21,000 OBO
Call 920-596-1888
(Leave message and your call will be returned) P7



2000 Freightliner FLD 112: C-10 CAT 370 hp w/Jakes, 10-spd., 12 FA/40 RA air-leaf susp., new 80 BBL vac tank with new 350 cfm liquid cooled Wallenstein vac pump. Excellent condition and ready to work. Only 370,000 miles!!\$58,500
720-253-8014 P6



1983 GMC C7D064: Flatbed truck with crane.\$10,000
Call Danny 561-662-4935
Email: Dannelsseptic@comcast.net P7



2007 Sterling Cab: With 3600 gallon aluminum P/V tank with Juro-Pak R260.\$116,000 including FET
800-722-8384 P6A



2004 International 4300 DT 466: Air brakes, air conditioning, new 2150 gal. tank, new 400 Masport pump, liquid cooled, new tires on rear. ..Call for pricing
937-372-1113 P6



1999 International 4700 LP: 16' flat bed with another 3' lift, 23,000 GVW, 238,115 miles, T444E 190 hp, Allison auto. AT 545, A/C, work lights, storage box & water tank.\$9,000
Call Doc 321-269-9957 P6



1989 Ford Cargo: 72,000 miles, 33,000 GVW, 2500 gal. vac tank, brand new clutch, lots of new parts. Used daily and ready to work.....\$25,000
207-667-8806 P6



2005 Peterbilt 357: Polished 4000/500 dual compartment Progress tank, C13 410 hp, 8LL trans., 46000 rears on Hendrickson rubber, 4.33 ratio, Masport vac pump, prepped for jetter pump, alum. boxes, 3 inlets, 1 quick dump valve, 113,000 miles, fully serviced, inspected, balance of OEM warranties, clean, one-owner southern truck.\$112,000 OBO
717-354-3199 P6



1995 Freightliner FLD112: 3176B, 350 hp Cat w/Jake, 10-spd. Fuller, 20,000 FA/46,000 RA, w/lift axle, 4,000 gal., rear open dump, Presvac 413 cfm vac pump, 200K miles.....Asking \$52,000
610-759-3290 P6

Pumper TRUCK STOP

see photos in COLOR at www.pumper.com



June



1999 Vactor 2110/Sterling Chassis: Unit completely rebuilt and with warranty. Vactor 10-yr. body, 80 gpm @ 2500 psi pump, loaded with optional items. Chassis engine Cat 3126, trans. Allison auto.\$95,500 OBO (Stk.#1445P04)
Call Joe 312-208-6373 P6



2000 US Jett 10K and 4K: 600 gal. tank, 100 hp Deutz, 747 hrs., mounted in 14' heated box on a 2000 Chevy 6500, 45K, Cat dsl., excellent condition.
641-673-9377 or 641-660-6991 CPBM



2004 NLB Model 17350D Liquid Blaster: Rated for 35 gpm @ 17,000 psi, featuring NLB Model 350 pump, 732 hrs. on blaster. Mounted on 1997 Peterbilt with 309,090 miles.\$120,000
269-375-9595 P6



2002 Hino: 55,000 miles, in service for just 2 years.\$35,900
Call Terry 734-654-8855 PBM



1996 Western Star: Cat, 2004 Masport HXL15WV on truck, 2004 Troxell 5460, custom made flat bed mounts to truck, one man, 15 min. All excellent condition.\$92,000
Neal 951-780-2255 P6



2007 International (Pre-Emission) DT 466 - 4300: Air brakes, auto. Allison trans., stainless steel tank, 1100 waste, 400 fresh, Conde pump, 43,000 miles, excellent condition. Built by Best Enterprises. ...\$65,900
417-257-4088 P6



1991 Vactor 2110-38: Ford L8000 3-axle, Ford diesel, Allison, engine brake, rebuilt PD blower, 60 gpm @ 2000, 65,000 miles on axles, 256,000 miles on odometer. Located in NorCal.\$42,000
707-433-8053
Email: admin@unplugu.com P6



2000 Freightliner FL70 with 00' Stetco 950T Catch Basin Cleaner: Cat 250 hp engine, Fuller trans. Excellent condition. The 950T body has never been used!!\$35,000
KLM Companies 617-909-9044 P6



1989 Vactor 810 Ford L8000: 136,826 original miles, single stage 60 gpm pump, 1200 gal. fresh water holding tank, single rear axle, newly painted.\$25,500 OBO
1-866-352-6870 P6



2002 F4900 International: 3300/300 aluminum tank w/site glasses/tube. Wittig vacuum pump, 2400 psi jetter @ 14 gpm w/power reel, heated valves, cruise, heated mirrors. 41,400 miles. Excellent condition.\$59,000
636-461-2444 P6



2004 Ford F550 Wrecked: 2004 Pik Rite tank 700/400 gallons, tank pump right angle drive, excellent shape, 2-unit rack. Pick up at our location. Not chassis.\$16,000 OBO
860-887-6542 P6



Partnership Split, Aquatech B15 Vac Truck GMC 1988: Great condition. GVW 50,500, Cat 3208 motor, 90,000 miles, jet pump Gaso Spencer lobe blower, extra part truck.\$35,000
724-864-4459 P6



2001 Ford 550: Keith Huber tank, 350 fresh, 500 waste, 200,000 miles, new transmission.Asking \$15,500 OBO
207-646-2180 P7



2002 IH 4300: Progress aluminum tank, 500 fresh, 1500 waste, new clutch, good rubber, 180,000 miles, clean truck.Asking \$31,500 OBO
207-646-2180 P7



1989 Vactor 12-yr. Catch Basin Cleaner: Telescopic boom, 2-stage fan, 1989 Peterbilt 320, auto trans., Cummins L10 diesel, only 65,000 miles on truck.\$24,500 OBO (Stk.#30508M1P05)
Call Joe 312-208-6373 P6



1995 Ford L-8000, Vac-Con V-390: 8.3 Cummins, John Deere diesel upper, 3-stage blower, 9 cu. yd. debris body, 37,789 miles, 1,389 hrs. vac unit, 527 hrs. jetter.\$47,900
814-696-4343 - Hollidaysburg, PA CMP6

Pumper

see photos in COLOR at www.pumper.com

TRUCK STOP



June



1985 GMC Brigadier: L10 Cummins, 7-spd., newer 3600 gal. tank & vac pump, new brakes & tires. This truck has been used daily and is very sound and ready to work.\$14,500

877-898-5104

hullstruckbodies.com

P6



2006 IH 4300: DT466, 250 hp, 6-speed, 2150 gallon steel tank, Jurop R260 pump, 80,000 miles.

888-848-3727

P6



1993 Vactor 2110: 10-yd. debris body, single stage fan, 4' extendable boom, telescopic rotating hose reel, formerly municipally owned unit with low hours and miles. Mounted on 1993 Ford L8000, diesel/automatic. (Stk.#1483P05)

Call Joe 312-208-6373

P6



1999 VacCon: 44,463 mi., 12-yd. debris tank, 3-stage fan, extendible boom, equipped for hydro excavation, 40 gpm @ 3000 psi, excellent condition. **2001 GMC CCTV** Pearpoint explosion-proof system, 45,863 miles, color video, printer, tractor, excellent condition. ...Both units \$110,500

Call Lee 770-560-0858

P6C7



2005 Flowtrend Dewatering Box: 15-yard.\$15,000 OBO

Contact Ryan @ 801-430-7287

P6



1994 Vactor 2110/1995 IH 2554 Chassis: Unit repaired by Vactor dealer to factory specs. 10-yd. body, 60 gpm @ 2000 psi pump, loaded with Vactor options. Chassis engine DT566, 250 hp, Allison MD3560 trans. (Stk.#1452P04)

Call Joe 312-208-6373

P6



1992 Peterbilt: 3406B, Cat engine, Juropak pump, Model PNR 142D, 4,000 gal. alum. tank (epoxy-lined) Trailmaster. Ready to go!

720-253-8014

P6



1999 Vactor 2115/IH 2574 Chassis: Vactor 15-yd. body, 80 gpm @ 2500 psi pump, loaded with optional items. Chassis engine Navistar A300F, 300 hp, Eaton Fuller trans. (Stk.#0308C1P04)

Call Joe 312-208-6373

P6

BE ONLINE & IN PUMPER, CLEANER OR MSW FOR ONLY \$125!

Please print ad legibly with correct punctuation and PHONE NUMBER. Don't forget to send photo!

RATE \$125 PER AD, PER MONTH, PER PUBLICATION WITH A 30-WORD MAXIMUM – **PLEASE NOTE:** You can only advertise **ONE TRUCK** for sale per ad.

DEADLINES **PUMPER: 10TH OF THE MONTH • CLEANER & MSW: 1ST OF THE MONTH** – For example: Jan. 1st would be the deadline for Feb. Cleaner.

ADVANCE PAYMENT **NO BILLING FOR TRUCK STOP ADS.** Payment must be received in **ADVANCE** before publishing.

Enclosed is \$ _____ for _____ ad(s) to run _____ month(s) in

PUMPER/Pumper Trader MSW CLEANER ALL 3 PUBLICATIONS (TRIPLE DOLLAR AMOUNT)

Company Name _____

Address _____ Phone _____

City _____ State _____ Zip _____

• **MAIL** this completed form with payment and photo to:
COLE Publishing Inc., P.O. Box 220, Three Lakes, WI 54562
(Make check/money order payable to: COLE Publishing Inc.)

• **ONLINE** ad form at: www.pumper.com; www.pumpertrader.com,
www.cleaner.com, www.mswmag.com

• **FAX** this completed form to: 715.546.3786 and **E-MAIL** photo to:
truckstop@mswmag.com, truckstop@pumper.com, truckstop@cleaner.com

PLEASE FILL OUT CREDIT CARD INFORMATION COMPLETELY:

CREDIT CARD NO. _____ V-CODE _____ EXP. DATE _____

CARDHOLDER NAME _____ PHONE _____

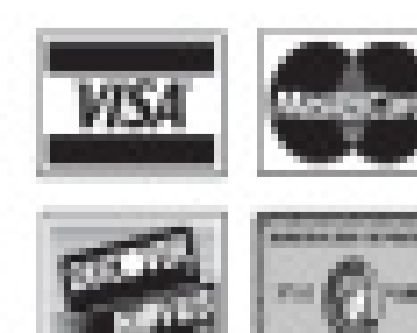

Green since 1959!

For all your Onsite Wastewater Needs



D-Boxes



Heavy Duty Cover and Adapter Ring for Corrugated Pipe



Pump and Filter Alarms



Effluent Filters



Risers



1-800-701-3942

For a Free catalog or to see other products call or visit our website: www.zabelzone.com

ALWAYS IN YOUR CORNER

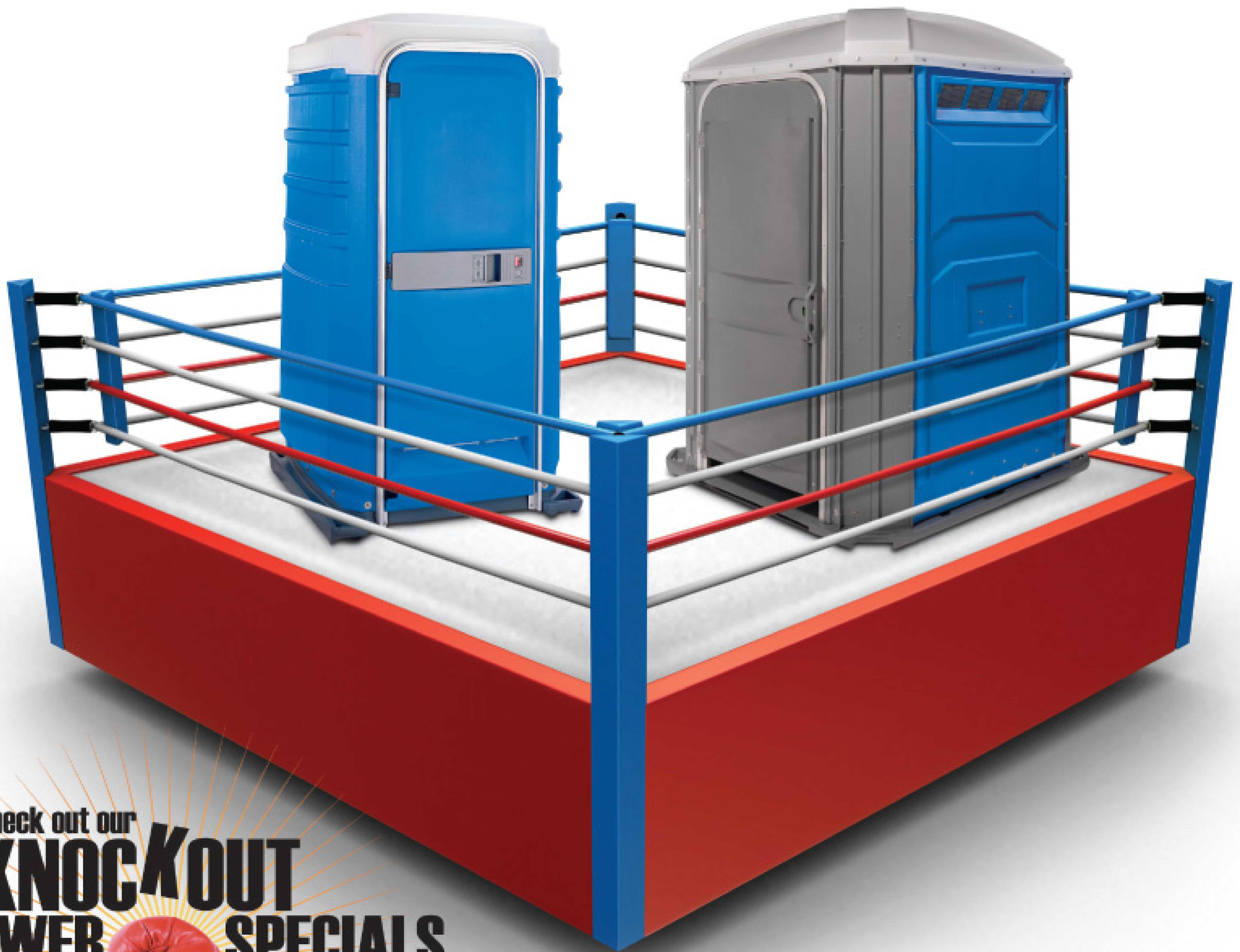

Check out our
**KNOCKOUT
WEB
SPECIALS**



Tough Products & Knowledgeable People
there when you need us

800-292-1305

www.polyjohn.com

Go to www.polyjohn.com and
check out our seasonal promotions.

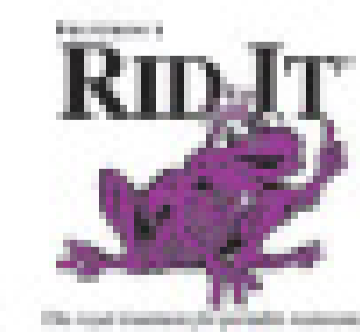
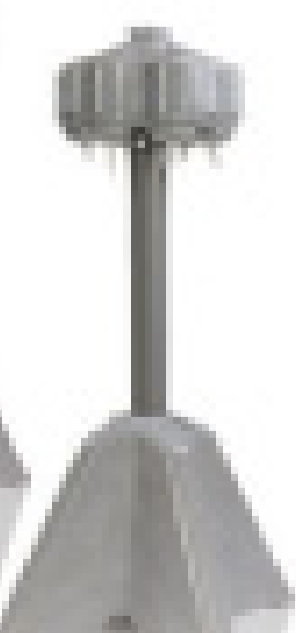

EARN MORE • SELL MORE • SERVICE BETTER

PRESVAC

**The Leader
In Vacuum
Technology**

Bright finish Aluminum Tanks
for the Septic Pumping
Industry... Standard
tank models from
2,000 gallons
to 5,000 gallons.



Hydro-Trencher - 5300 CFM air flow/28" HG vacuum
with 8" hydraulic actuated boom, 3000 U.S. gal.
debris tank (stain. steel 316), 1000 U.S. gal.
water tank (stain. steel 316), 9 G.P.M. water
pump with pressures to 5800 p.s.i.

Powervac 5300 for wet/dry operation

5300 CFM air flow/28" HG vacuum, Dump chutes
extended to rear of truck, Stainless steel 316,
DOT 407/412



Liquid Truck

Designed for industrial liquid applications

www.presvac.com

Nationwide Sales & Service
Call a Presvac Dealer in Your Area!

4131 Morris Drive • Burlington, Ontario, Canada L7L 5L5 • Fax: 905-681-0411

905-637-2353 • 800-387-7763