

NEW EXPO PRODUCTS • PORTABLE SANITATION

DEDICATED TO THE LIQUID WASTE INDUSTRY

Pumper

April 2008 www.pumper.com \$5.00 U.S.

Pumping in PARADISE

The future
is sunny
for Hawaii
contractor
PAGE 46



A Buying Opportunity

Expo offers
deals on wheels
and new products

PAGE 36



Our Trucks Are Ready. Are You?

Select From Existing Inventory or Build Your Own.

Available Inventory

- 4800 Aluminum Septic Tank
- 3600 Aluminum Septic Tank
- 2500 Aluminum Septic Tank
- 3400 X Ten High Tensile Carbon Steel Front Lift (Full Rear Opening Door)
- 2200 Stainless Steel Premium Septic Tank
- 3200 Stainless Steel Premium Septic Tank
- 3600 Aluminum Septic 2008 Kenworth T300
- 1250 Alum PRT 2007 Ford F550 2x4
- 1500 Alum PRT 2007 Ford F550 4x4
- 800 Alum P&D Combo Unit 2007 Ford F550 2x4
- 2200 Alum Septic 2007 7500 Chevrolet
- 2200 Alum PRT 2008 Ford F750 AT AB
- 1500 Alum PRT 2008 Ford F550 2x4
- 2000 Alum PRT 2007 International 4200 AT AB

PORTABLE RESTROOM TRUCKS

- (6) 950 MD Steel - \$51,000 w/Ford F550 Chassis
- (6) 1250 MD Steel - \$59,328 w/Ford F650 Chassis
- (6) 1600 MD Steel - \$63,128 w/Ford F650 Chassis

Available For Immediate Delivery!



\$ 103,652

**Kenworth T-300
3600 Aluminum**



\$ 85,965

**Peterbilt 335
2500 Aluminum**

Order Today!

800-328-3332

www.satelliteindustries.com



Imagine The Possibilities

Plug & Play SYSTEMS

THANK YOU
FOR MAKING OUR SHOW A
SUCCESS

Rotary Vane Systems include:

Pump • Base • Inlet Filter • Secondary Scrubber • Gauges • Vacuum Relief Valve • Right-Angle Gear Box • Four-way Valve

HXL4V Air Cooled

- Air Cooled Rotary Vane Pump
- 160 CFM
- 20" Hg Continuous
- Leader in Porta-Potty
- Laser Cut 3/8" Base
- Right Angle 1:1 Gear Box
- SureFlex Coupling
- Inlet Filter w/50 mesh stainless element
- Compound Vacuum/ Pressure Gauges
- Completely Assembled & Tested
- Horizontal Scrubber
- Vacuum Relief
- Pressure Relief



HXL400WV Liquid Cooled

- Liquid Cooled Rotary Vane Pump for Heat Stability and Extra Reliability
- 400 CFM
- 25" Hg Continuous
- Laser Cut 3/8" Base
- Right Angle 1:1 Gear Box
- SureFlex Coupling
- Completely Assembled & Tested
- Horizontal Scrubber
- Vacuum Relief
- Pressure Relief
- Inlet Filter w/50 mesh stainless element
- Compound Vacuum/ Pressure Gauge

RB-DV45 High Vacuum Blower

- Air Cooled Air Ballast Ported Rotary Lobe Blower
- Air Flow Up to 494 CFM
- 27" Hg Continuous
- Right Angle 1:2 Gear Box with Flex Coupler
- 12 Volt Gear Box Cooling System
- Remote 4-Way & Check Valves
- Inlet Filter w/10 Micro Polyester Element
- Exhaust Pressure Gauge & Gear Box Temperature Gauge
- Pre and Post Inlet Filter Vacuum Gauges
- Completely Assembled & Tested



TO ORDER CALL: 1(800) 228-4510
www.masportpump.com

Masport®



Restroom Dropped On Site

NEW PORTABLE, COMMERCIAL QUALITY RESTROOMS



Interior/Restroom Stalls Interior/Utility Sink Storage Tanks

- Heat & AC
- Lighting
- Rubber or Rhino Lined Flooring
- Electrical Outlets
- Hot Water Heater
- Utility Sinks
- Urinals & Stalls

- Self Contained 1500 gal Fresh Water Tank/1500 gal Sewage Tank
- Or Hook Up Directly to Existing Utilities
- Level Indicator Alarm

PROFIT GENERATION

- \$ Monthly Rental
- \$ Bulk Pumping
- \$ Potable Water Hauling

POTENTIAL CUSTOMERS

- Special Events
- Industrial/Construction Sites
- Community Functions

DROP BOX 1.888.388.7768
www.dropboxinc.com

LOCATE WITH THE BEST

WHETHER YOU ARE JUST GETTING STARTED OR YOU ARE AN OLD PRO, you can rely on Prototek for the best flushable transmitter and receiver systems in the industry. **FLUSH AND FIND** Locate underground nonmetallic tanks and lines with our orange AT-12 flushable transmitter and AR-1 receiver. Locate in cast iron or nonmetallic lines with our blue FT-8 flushable transmitter and FR-1 receiver. Recycle your used AT-12s or FT-8s back to us for credit toward your next purchase. Use your AR-1 for tracing metallic lines or utilities with Prototek's powerful and versatile **BuzzBox!** Operates at 223 KHz, 3 watts max power, in

3 ranges, Ground rod and cables included.



Prototek



ECONOMICAL • EASY 800-541-9123

www.prototek.net email: prototeksales@prototek.net

PUMP VANES

BULLET-PROOF your pump with KEVLAR BLADES

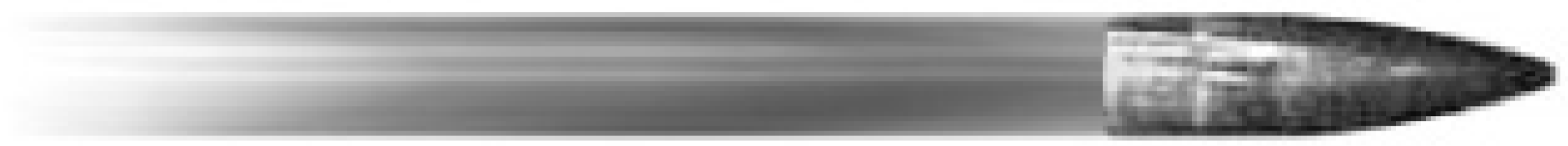

DURA FLO BLADES

Features:



- Long lasting performance
- Fully heat-treated material
- Operating temperature to 400°
- Resistant to wear and warpage

Benefits:



- Made in the U.S.A
- Longer rebuild intervals
- 100% guaranteed
- Factory direct

VANES AVAILABLE FOR MOST PUMPS IN THE INDUSTRY

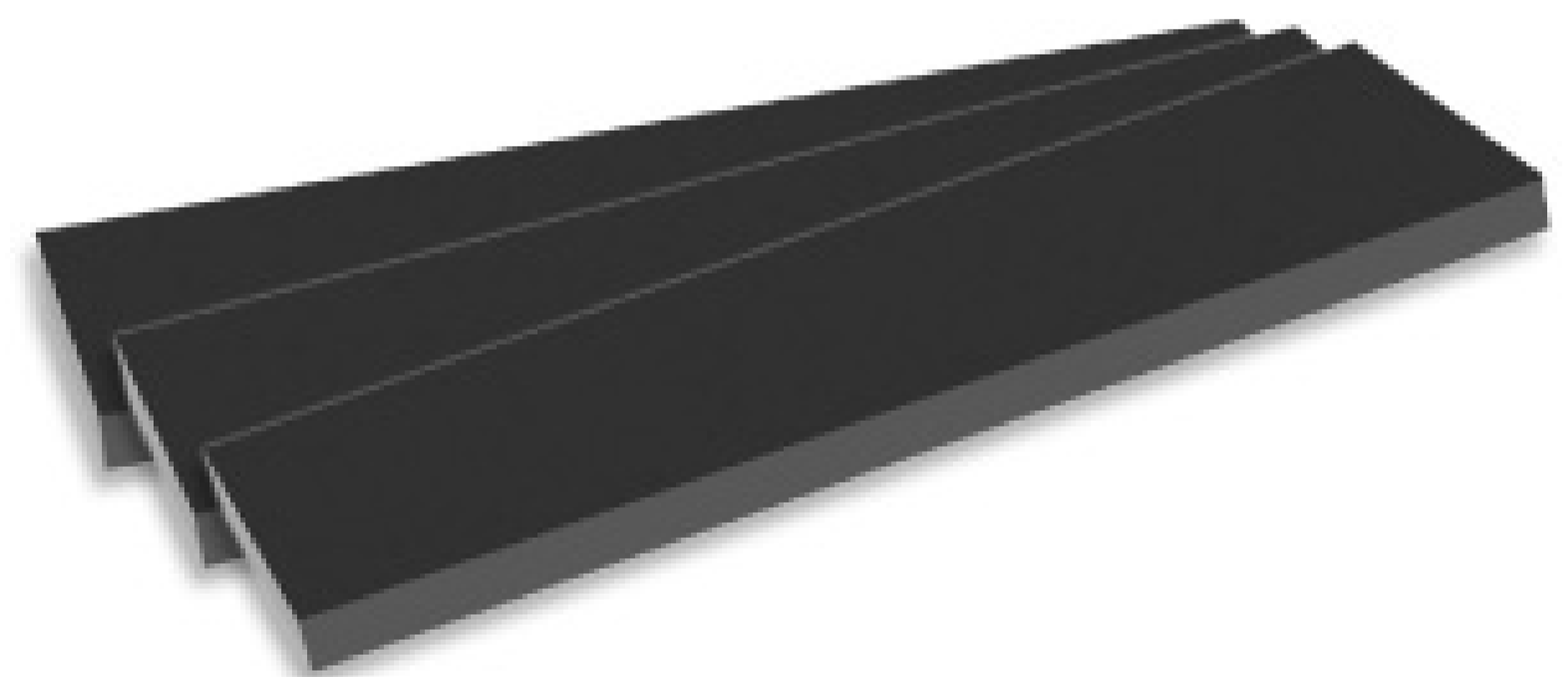

POWER flo

1-800-758-4788

POWERFLO PRODUCTS INC. • 2755 N. Gaviota Ave. • Signal Hill, CA 90806

27th TRUCKS INC.

WORLDWIDE EXPORTERS

8975 N.W. 27TH AVE. | MIAMI, FL 33147

PH: 305.835.9030 | EMAIL: INFO@27TH-TRUCKS.COM

Contact Alan @ 305-457-8058 or
Armando @ 786-267-3026

2 Year
Factory Warranty
on Pumps



2002 MACK

4500 Gallon Aluminum Tank, 10 Spd.,
350 HP, with Tri Axle, Jurop Pump
LC420 Contender (Extras Included) with
High Quality Custom Paint Job.



2001 MACK VISION CX613

4000 Gallon With Dumping
System, Jurop Pump LC420
READY FOR IMMEDIATE DELIVERY!



SOLD
SOLD IN THE PUMPER EXPO
THANK YOU Kirby Jr.

5 year Factory Warranty
on Carbon Steel Tanks



2000 PETERBILT

C12 Cat, New 4000 Gallon
Aluminum Tank, Fruitland Pump
RCF 500, 350 C.F.M., Custom Build.
Ready for Immediate Delivery!
Beautiful Truck!



2003 PETERBILT 379 SHORTHOOD

10 Spd., N14 Cummins, 470 HP, 5000
Gallons with 200 Fresh Water Com-
partment, Jetter System, Tri Axle,
Fruitland Pump RCF 1200 650 C.F.M.
Best Truck of the Year.



SOLD
SOLD IN THE PUMPER EXPO
THANK YOU Jose Mora.



1999 PETERBILT C12

C12 Cat, 10 Spd., 430 HP,
3600 Carbon Steel Septic Tank,
Jurop Pump LC 420 Contender
Beautiful Truck!



2000 PETERBILT C12

Cat 430 HP, 3600 Gallon
Progress Aluminum Tank
Fruitland Pump RCF 500,
350 C.F.M.



SOLD
THANK YOU Robin & Nile
from Texas Pride

10 Year Factory Warranty
on Aluminum Tanks

WWW.27TH-TRUCKS.NET



ARTICLES

46
Pumping in Paradise
- Sharon Verbeten

On the cover: A technician for Paradise Lua services a unit on the Hawaiian island of Oahu. (Photo by Anthony Consillio)

10
**Reading Between the Lines:
Information Overload?**

Here are a few ideas to make a difference with the avalanche of information you gathered at the Pumper & Cleaner Expo.

- Jim Kneiszel

16
**Building the Business:
Panning for Golden Customers**

Inexpensive marketing tools and concepts will help you mine new and repeat business.

- Joe Weber

26
**Rules and Regs:
Vermont Revises Rules to Allow
Broader Use of Onsite Systems**

- Scottie Dayton

36
Expo 2008: A Buying Opportunity

Liquid waste professionals show their purchasing power at the Pumper & Cleaner Expo.

- Ed Wodalski and Jim Kneiszel

60
**Pumper Interview:
Bruce is Bullish on Portable
Sanitation**

New United Site Services CEO says the industry will overcome a slump caused by the housing downturn.

- Ken Wysocky

FOLLOWING

66
Saluting the Industry

NAWT hands out annual awards at the Pumper & Cleaner Environmental Expo.

- Jim Kneiszel

68
Hitting the Books

Studios Washington pumper Mike Ellingson does his homework to overcome financial and technological challenges.

- Ken Wysocky

REGULAR FEATURES

80
**Reader Pipelines:
Strength in Numbers**

Atlanta-area companies join hands to trade ideas on dealing with an economic downturn and raising professional standards.

- Ken Wysocky

92
**Septic System Answer Man:
Choose Drainfield Carefully**

Get under the topsoil and research the best possible effluent distribution plan before you start digging.

- Roger E. Machmeier, Ph.D

104
Classy Truck of the Month

We feature Martin Septic Service, Winchester, Va.

112
**Association News; Training and
Education; Calendar**

Coming in May

Special Issue: Onsite Septic Systems

- **Pumper Interview:** An Indiana company wants to drive the onsite technology bandwagon
- **Contractor Profile:** A third-generation Florida pumper strikes out on his own

Pumper

DEDICATED TO THE LIQUID WASTE INDUSTRY

www.pumper.com

Published monthly by

COLE Publishing Inc.
1720 Maple Lake Dam Rd.
PO Box 220
Three Lakes WI 54562

© Copyright 2008 COLE Publishing Inc.
No part may be reproduced without
permission of the publisher

In U.S. or Canada call toll-free 800-257-7222
Elsewhere call 715-546-3346
E-mail: info@pumper.com
Web site: <http://www.pumper.com>
Fax: 715-546-3786

Office hours 7:30 a.m. - 5:00 p.m.
Central Time, Monday - Friday

SUBSCRIPTION INFORMATION: A one year (12 issue) subscription to *Pumper* in the contiguous 48 U.S. states costs \$16 (24 issues for \$26; 36 issues for \$36). Subscriptions to Canada or Mexico cost \$28 per year (24 issues for \$54). Subscriptions to all other foreign countries cost \$82 per year. Subscribers are guaranteed monthly delivery of the magazine. To subscribe, send company name, mailing address, phone number and check or money order (U.S. funds payable to COLE Publishing Inc.) to the address above. MasterCard, VISA and Discover are also accepted. Supply credit card information with your subscription order.

CLASSIFIED ADVERTISING: RATE: \$1.00 per word, per month. Minimum of 20 words or \$20. All classified advertising must be PAID IN ADVANCE. DEADLINE: Classifieds must be received by the first of the month for insertion in the next month's edition. PHONE-IN ADS ARE NOT ACCEPTED. Ads may be faxed only when charging to MasterCard, VISA or Discover. Please supply all credit card information with faxed ads. Be sure to include your phone number (with area code) in your ad. Make checks payable to COLE Publishing Inc. and mail with classified ad to the address above. CLASSIFIED ADVERTISING APPEARS NATIONWIDE AND ON THE INTERNET. Not responsible for errors beyond first insertion.

DISPLAY ADVERTISING: Call 800-994-7990 and ask for Jeff, Jim, Kim or Winnie. Publisher reserves the right to reject advertising, which in its opinion is misleading, unfair or incompatible with the character of the publication.

CIRCULATION: Circulation averages 24,493 copies per month. This figure includes all three circulation regions (nationwide) and international distribution.

**2009 PUMPER & CLEANER
ENVIRONMENTAL EXPO INTERNATIONAL**



Education Day:
February 25, 2009

Exhibits Open:
February 26-28, 2009
Kentucky Exposition Center
Louisville, Kentucky

www.pumpershow.com



moroPUMPS

"Over 50 years of service and here to stay!"

Ask for a quality Moro pump from your truck builder, or call us for the dealer nearest you.

Pittsburgh, PA . 1-800-383-6304 . fax 412-269-4172 . www.morousaeast.com . moroeast@attglobal.net

St. Louis, MO . 1-866-383-6304, 636.584.8844 . fax 636-583-2044 . www.morousaeast.com . moro@charter.net

Isn't it time to UPGRADE to a MORO?

Complete Right Angle Packages

Completely Assembled

Pumps available from 176-1642 cfm

M3
176 cfm



M10
230 cfm



PM80 350 cfm

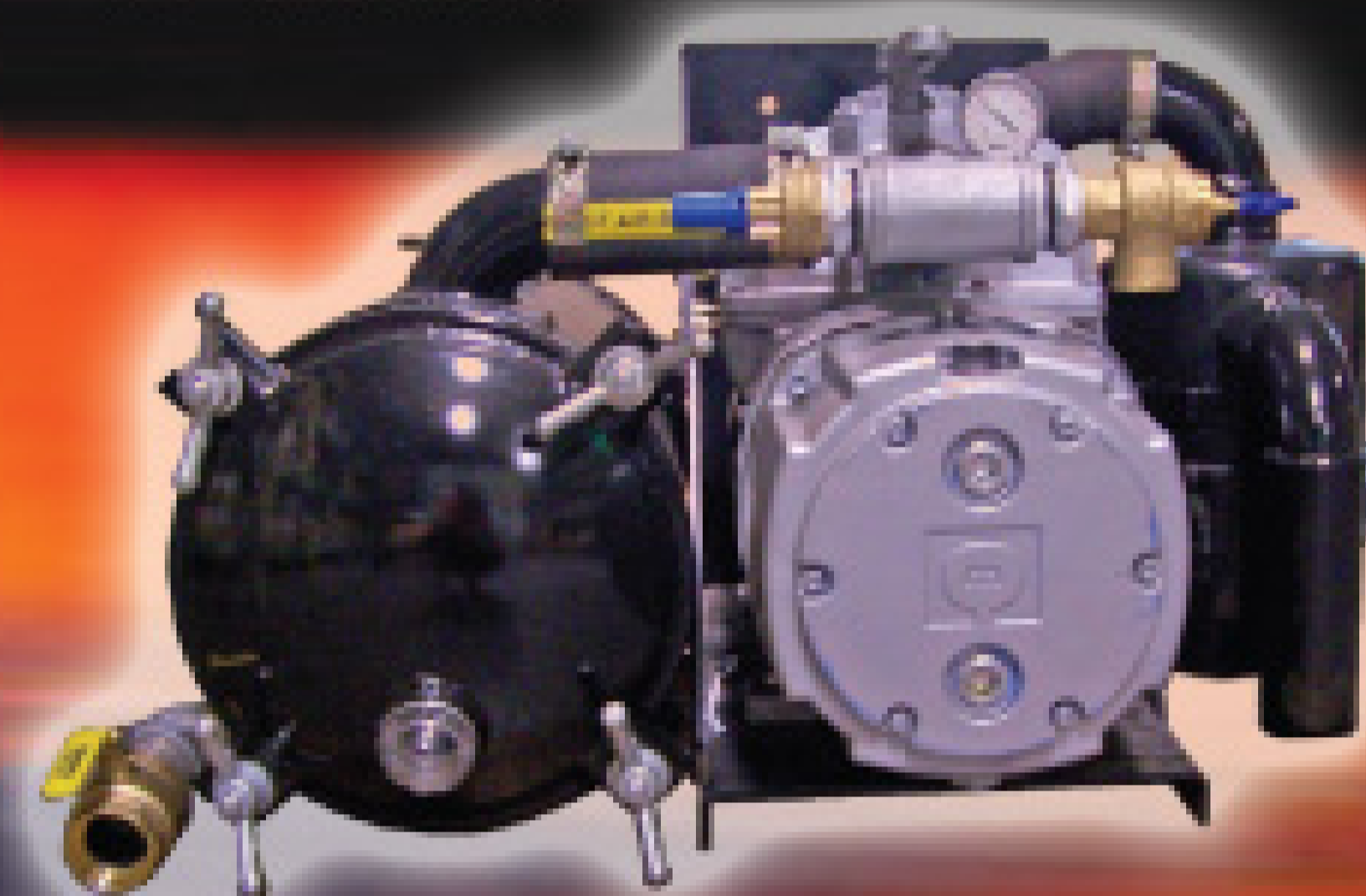

PM100
460 cfm



RIGHT ANGLE, HYDRAULIC,
GAS OR DIESEL PKGS.
AVAILABLE
ON ALL PUMPS



PM2600 824 cfm

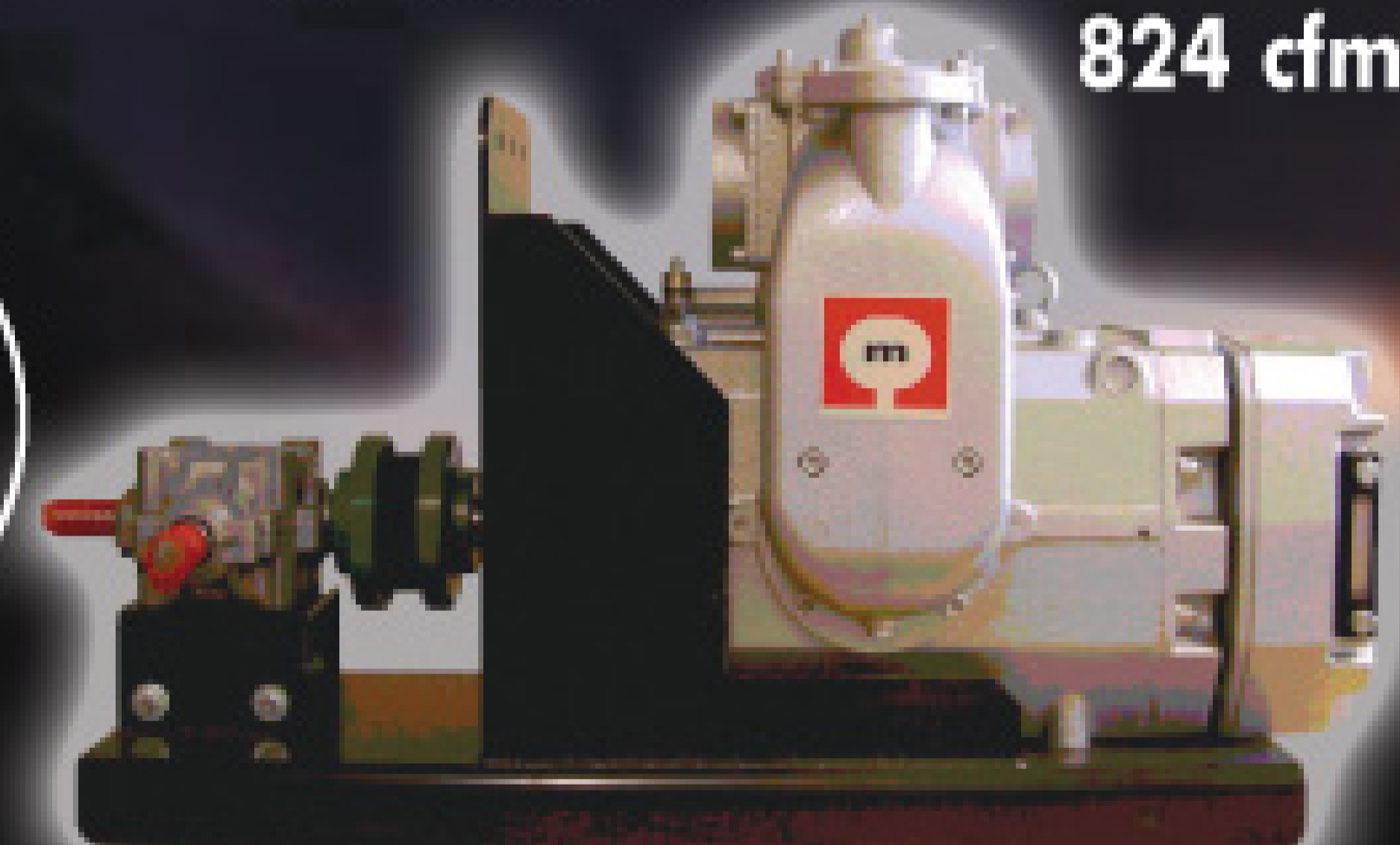

DC-STAINLESS Washdown Pump

NO COMPARISON



NO
more
RUSTY
water!

OUTPERFORMS
the Burk's
cast iron
DC-10!

NO More
FROZEN
pump!



316 Stainless Steel Mounting
Brackets, Pump Head & Impeller

Quality RIV Components In Stock — Ready for Shipment



ACCU-LEVEL Accurate Tank Volume Measurement

No Balls • No Tubes • No Floats • No Worry!
No Internal Tank Components

Get paid for what you pump!

Only pay for what you dump!



Level Indicator

Factory calibrated, the general purpose indicator reads 0-100% of volume in gallons. A single push button allows users to scroll through their active channels.



Pick-up Unit

The general purpose two-wire transmitter provides non-contact level measurement up to 32' and is ideally suited for challenging corrosive, coating or waste liquids.

ADVERTISER index

April 2008

27th Trucks, Inc.5

A



Abbott Rubber Co., Inc.28



Abernethy Welding & Repair ..121
Accent Manufacturing93
ACG Equipment Finance20
Acro Trailer Company98



Advance Pump & Equip.45
Advanced Containment Sys. ..76
Alpha Mobile Solutions40
AltunaMats22
Ameri-Can Engineering20
American Machine & Tool Co. ...98
Amigo Truck Ltd.26
Amthor International82
Aqua Ben Corp.124



Aqua-Zyme Disposal Sys.82



Arcan Enterprises Inc.108



ARMAL Inc.91



Armstrong Equipment42, 96
Atlanta Rubber & Hyd.74

B

B & W Mantrad Inc.76
Badger Truck Center90



Bandlock Corp.129
Best Enterprises, Inc.95
Big Fish Environmental10
Black Tie Mfg. Inc.57
Brenlin Co. Inc./Seal-R106



Bright Technologies56

C

Cadman Power Equipment.18



Cam Spray18
Cape Cod Biochemical18
Capital Partners LLC96

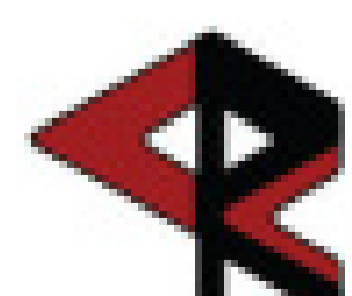

Capital Rubber Corp.42

C

Center Capital Corp.87



Chandler Equipment Inc.9
Chempace Corporation88
Circle D Truck Sales86



Clear Computing Inc.22



Comforts of Home32
Community Leasing50



Crust Busters/Schmitz Bros. ..58

D

Del Vel Chemical Co.81
Denver Truck Sales62
Dragon Products12-13
Drop Box Inc.4
Dunham & Morrow Inc.30

E

Ecological Laboratories30



Elastec/American Marine78
Engine & Accessory Inc.93
Excel Equip. & Supply89
Explorer Trailers - McKee50

F



F. S. Solutions106
Fergus Power Products124
Five Peaks Technology109



Flo Trend Systems Inc.84
Frontier Technology34
Fruitland Tool & Mfg.102

G

Gamajet Cleaning Systems66
GapVax Inc.99
Granite Leasing Co.108
Guzzler Mfg. Inc.55

H

H & M Vacuum Pumps104
Hampel Corp.73
Hannay Reels114
House of Imports11

I

Imperial Industries Inc.25

J



J&J Chemical Co.51
J.C. Gury Company Inc.88

J



Jag Mobile Solutions107

K

KeeVac Industries Inc.111
Kentucky Tank Inc.86
Key Commercial Corp.102
Kuriyama of America Inc.54

L

L.C. Tanks35
L.M.T. Inc.19
Labrie Environ. Group52
Lane's Vacuum Tank Inc.30

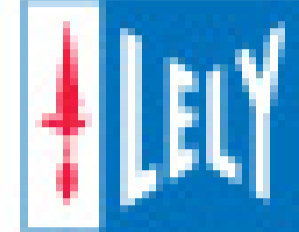

Lely Manufacturing Inc.43
Lely Waste Solutions14



Lenzyme/Trap-Clear Inc.96
Liquid Waste Industries28
Longhorn Tank & Trailer Inc. ..90

M



Marsh Industrial108



Masport Inc.3
Michigan Vacuum Truck Inc. 124
Micro Target Media100
Mid-Continent Truck Sales ..115
Mid-State Tank74
Milwaukee Rubber Prod.10



Moro USA East Inc.7

N

National Truck Center85
National Vacuum Equip.41



NuConcepts88

O

Overland Tank Inc.40

P

Pat's Pump & Blower24



Pik Rite, Inc.61
PolyJohn Enterprises131
Polylok Inc.130
PolyPortables Inc.15, 71
PolyPortables Inc./Green Way ..101
Power Vac Inc.74
PowerFlo Products Inc.4, 94
Precision Tank & Equip.72



Pressure Lift Corp.58
Presvac Systems Ltd.132

P

Prime Solution Inc.66
Prometheus Partners44



Prototek4

R

RA. Ross N. E.62



RABCO72



Ritam Technologies LP114
Robinson Septic Service66
Rocket Supply Corp.98
RotoSolutions Inc.102
RouteOptix Inc.54
Rush Refuse Systems53

S

Safety Pumping Systems32
Satellite Industries ..2, 64-65, 125
SEMO Tank56

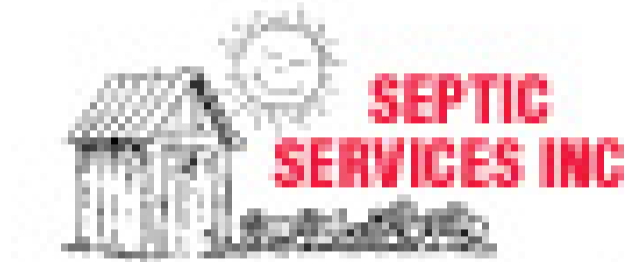

Septic Services Inc.52
Simple Solutions81
Sludge Mgt. & Reuse58
Smithco Mfg. Inc.84
Specialty B Sales100
Stuart Tank50
Super Products LLC34
Surco Products83
Sweet Septic Systems Inc.62

T

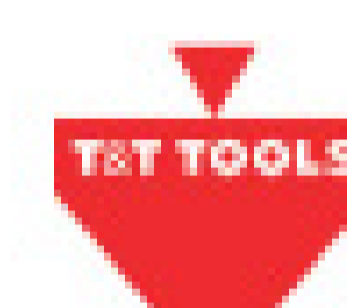

T&T Tools Inc.24



TankTec17
Tank Truck Service114



The Service Program34



Toico Industries Inc.23



Transport Truck Sales59



Transway Systems Inc.77
Truck Town Inc.32
TSF Company Inc.33
TST, LLC63
Tuf-Tite Inc.75

U

U.E.M.S.I.78

V

V.E. Enterprises Inc.105
Vac-Con, Inc.31
Vacutrux Limited29

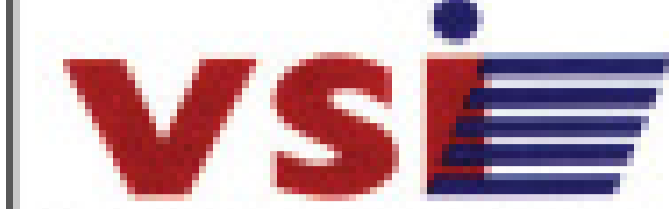

Vacuum Sales Inc.22, 79



VAR Co.14

W

Walex Products Co.27
Wallenstein Pumps-Elmira ..110
Wastequip Cusco Inc.67
Water Cannon110
Wee Engineer Inc.103



Wells Cargo COG94
Westmoor Ltd.21, 72
White River Distributors56
Wilcox Truck Sales54
Wolf Creek Co., Inc.106

Classifieds116
Marketplace122
Truck Stop126

REGIONAL ADVERTISERS

Western Supplement

(after page 66)

Armstrong Equipment5
Custom Tank & Equip.6
Erickson Tank & Pump7
James Wilbee Company.3
TRS Industries6
West-Mark Inc.4

Midwest Supplement

(after page 66)

Allied Tank5
Bosserman Tank & Truck6
Engle Fabrication Inc.6
Liberty Financial2
Marengo Fabricated3
Mid-State Truck Service4
Milwaukee Rubber2
Pierson Co.2
Rider Vacuum Sales7
T-Line Equipment Inc.8
V&H Inc.4

Eastern Supplement

(after page 66)

Allied Tank5
Andert6
Bosserman Tank & Truck6
Cellofoam2
Liberty Financial2
Manchester Hose4
Marengo Fabricated3
Southcoast Equipment8
TSI Tank Services7
V&H Inc.4

Jurop

NORTH AMERICA



NEW JUROP LC300 CONTENDER WATER COOLED VACUUM PUMP

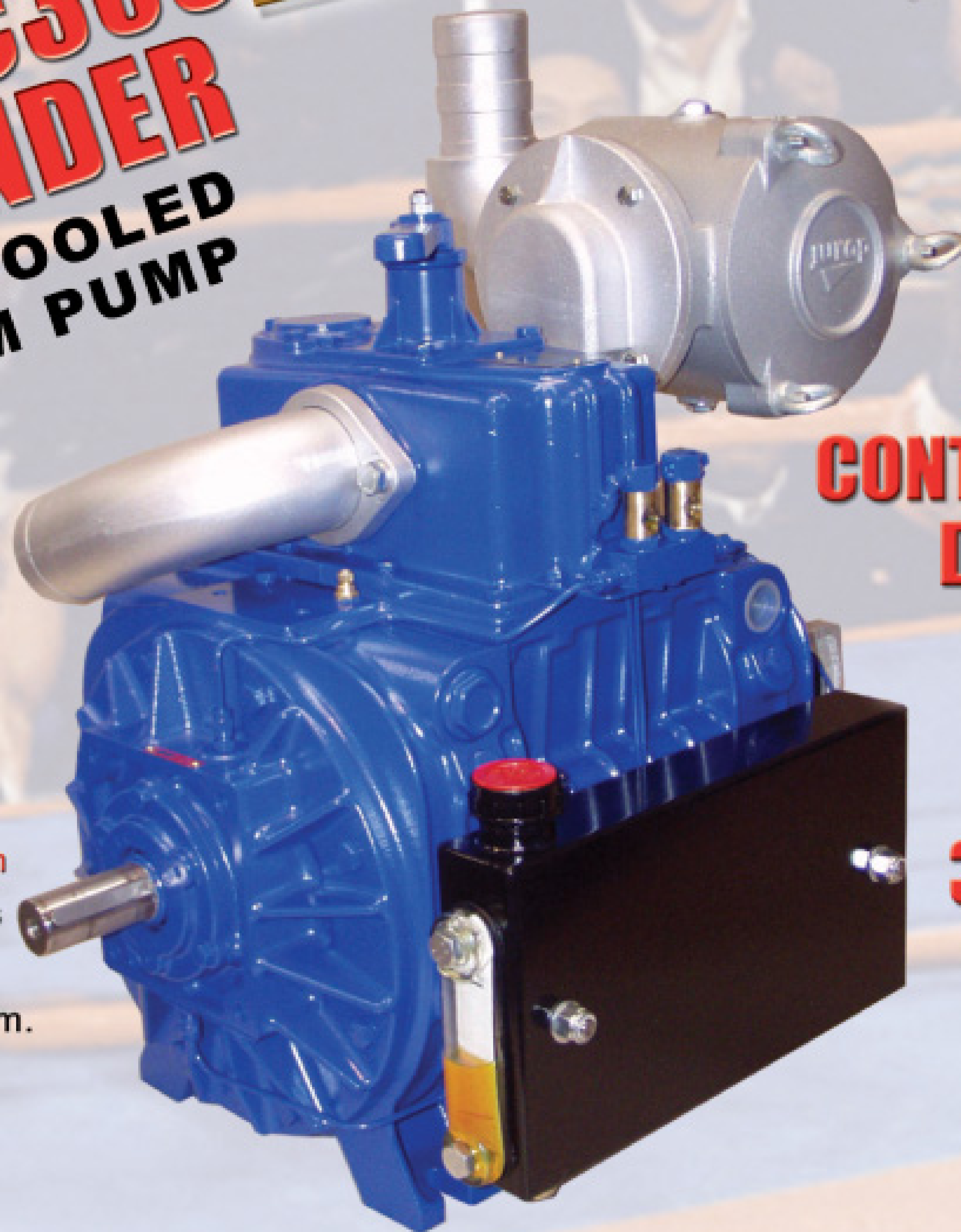

27"
**CONTINUOUS
DUTY**

JUROP HAS ADDED A NEW PUMP TO THE LC SERIES

This **Little Water Cooled Champion** supplies 300 CFM, 27" Continuous Vacuum and hooks to truck engine requiring no auxiliary cooling system.

300 CFM

LC420 CONTENDER

WATER COOLED VACUUM PUMP

The Proven Power of the **LC420 CONTENDER** Vacuum Pump by **JUROP** knocks out those challenging jobs efficiently and profitably.

This **Water Cooled Champion** supplies 425 CFM, 27" Vacuum, 25" Continuous Vacuum and hooks to truck engine requiring no auxiliary cooling system.



FOR A **JUROP** DEALER NEAR YOU CALL **1-800-342-0887** www.chandlerequipment.com

Make a Difference With Avalanche of Expo Information

By Jim Kneiszel, Editor

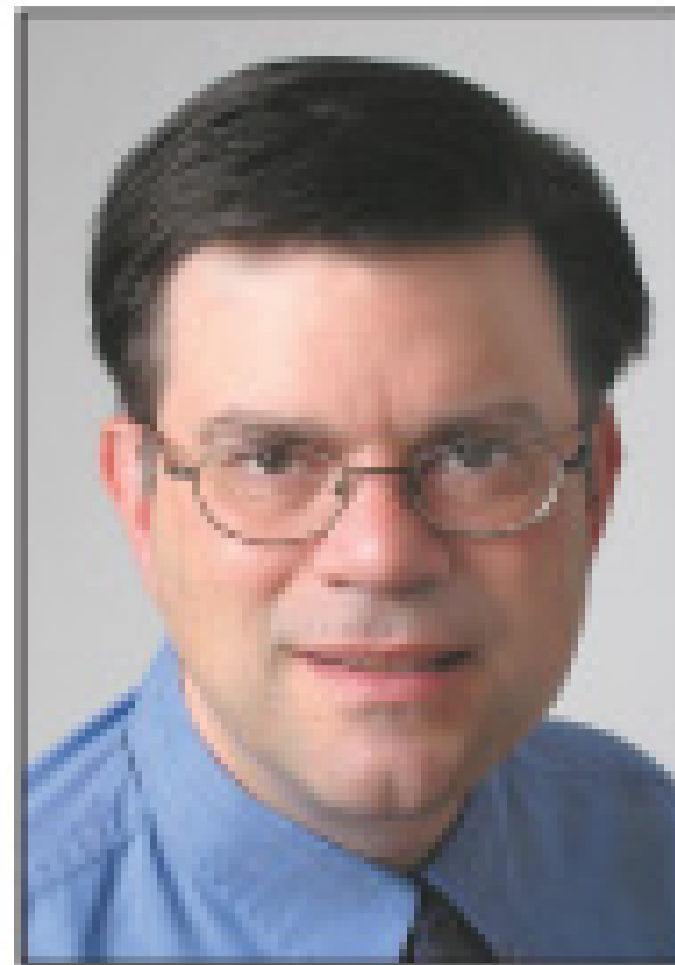

I am just returning from the Pumper & Cleaner Environmental Expo in Louisville, the industry gathering that gets its name in part from this publication. The major marketplace for the liquid waste industry has gotten bigger every year I've attended and provided me with incredible learning opportunities.

But talk about a big hangover! No, I'm not referring to an alcohol-induced stupor. This is more of an information-overload hangover.

I'm returning home with a Grinch-sized sack of materials — business cards, product brochures, promotional giveaways and scribbled notes — that I have every good intention to read over. My digital camera's memory card is stuffed with images to accompany stories.

It's with great trepidation that I hauled that sack to the office, knowing full well the challenge of processing all the useful information at the same time I'm trying to catch up with work that piled up while I was away.

Having met so many enthusiastic pumpers in Louisville, I know many of you are dealing with the same trade show hangover. To wring out all the benefits of attending the Pumper & Cleaner Expo, we must force ourselves to dump that bag of materials on the conference table and see how we can best take advantage of what we learned. Here are a few suggestions to get you started:

REVIEW EDUCATION DAY NOTES

Education Day was chock full of excellent presentations on best practices, safety and emerging technologies. Review your notes on the seminars you attended. If you want to dig deeper than your notes, or if you missed a seminar that interested you, you can order tapes or CDs of the presentations at www.conventiontapes.com or by calling 800/747-6334.

Turn your notes into a team meeting or tailgate safety talk with your staff. Or simply provide key employees with the tapes or CDs to listen to at their convenience. While these small steps aren't like taking staff along to the Expo, the effort will get valuable industry information in employees' hands and help stress the importance of professionalism in the workplace.

LOOK FOR A GOOD MARKETING IDEA

I'm sure you chatted with other industry professionals at the Expo, and from those discussions you can likely mine one idea to help your business attract more customers. Seasoned Expo attendees know the value of comparing notes with other contractors and come home with a boatload of good marketing ideas. Rather than try to implement a laundry list of new programs, choose one idea to focus your post-show efforts. Put all of the great ideas you heard in a file to use down the road as you have time.

TALK TECH WITH WORKERS

Shuffle through all the brochures and pull out the top 10 products you think could help you develop new niche service markets or run your business more efficiently. Gather the crew, pass around the brochures and find out if your workers on the front lines can see profit-building applications for the tools and equipment. You might be surprised to hear your drivers, for instance, come up with a great timesaving idea utilizing a new product you saw at the show.

START PLANNING FOR NEXT YEAR

If you attended the Expo this year, you're probably already pumped to go to the 2009 show. Start thinking about which of your employees would benefit from attending with you next year. If you missed the Expo, consider marking your calendar to attend next year, Feb. 25-28. We'll see you there. ■

Contact us: Pumper strives to serve the liquid waste industry with interesting and helpful stories. We welcome your comments, questions and column suggestions and promise a prompt reply to all reader contacts. Call 800/257-7222; fax 715/546-3786; e-mail Pumper editor Jim Kneiszel at editor@pumper.com.

Big Fish

ENVIRONMENTAL

Receiving & Processing
For
**Septage • Biosolids,
Fats, Oil & Grease**
Design • Build

P.O. Box 528 • 12608 Taylor Rd.
Charlevoix, MI 49720

PH: 231.547.4429 • FAX: 231.547.2057
www.bigfishenvironmental.com

Kanaflex® 220RS Rubber All-Weather Suction Hose

SUPER FLEXIBLE IN COLD WEATHER

Call for Low Prices on 100' Lengths & Coupled Hose Assemblies

A revolutionary new method of manufacturing rubber suction and discharge hose has drastically reduced costs to hose users. The new process, ten years in development, utilizes Kanaflex SBR TYPE "T" POLYMER to give the lightweight, rubber hose outstanding flexibility and long life.

New Series 220 rubber suction and discharge hose has excellent dimensional stability and is easy to couple. Manufactured in six sizes from 1-1/2" through 6", the hose is available in 100' lengths. I.D. and O.D. are smooth. Temperature range is -40° F to 160° F — ideal for industry and construction job site use.

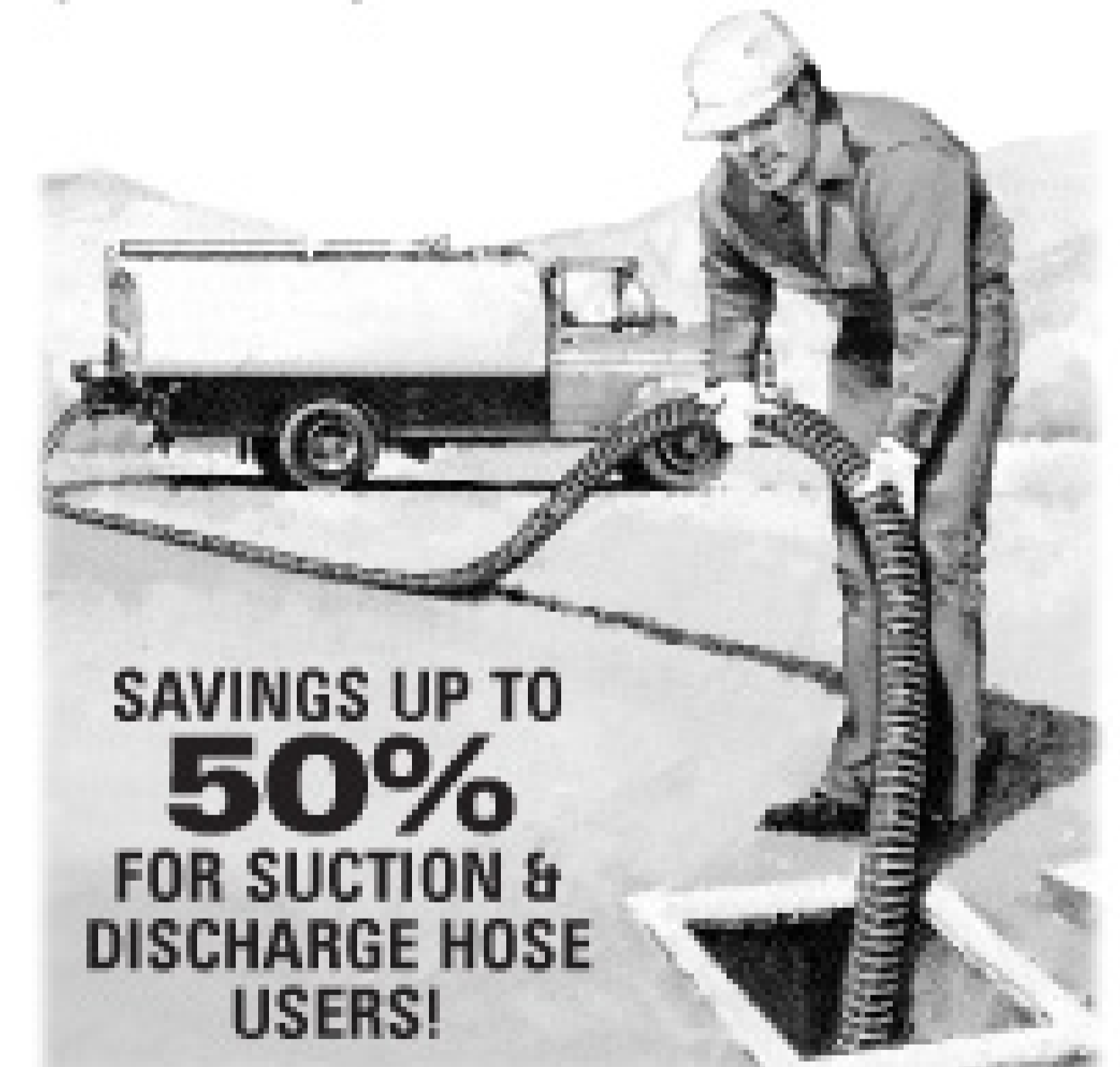

SAVINGS UP TO
50%
FOR SUCTION &
DISCHARGE HOSE
USERS!

Distributors of: Dunlop • Goodyear • Kanaflex • Plastiflex
Hi-Vac & Other Hose • P-T & Evertite Quickcouplers
Dixon & Le-Hi Couplings • Hose Clamps • Banding Equip.

MRP

Milwaukee Rubber Products, Inc.

Toll-Free
1.800.325.3730

www.milwaukeeerubber.com

FAX: 262.781.1742

MAILING ADDRESS: P.O. Box 451 • Butler, WI 53007

WAREHOUSE: N52 W13319 Falls Creek Ct. • Menomonee Falls, WI 53051



HOUSE OF IMPORTS **TRUCK SALES**

▶▶ SINCE 1947

CALL ANGEL AT:
786.258.3384
OR
305.691.4778

▶▶▶ WWW.HOUSE-OF-IMPORTS.COM

2008 PUMPER & CLEANER EXPO SHOW TRUCKS!



2005 PETERBILT 379
4,000 GAL. TANK - THANK YOU TO
BILLY HOOKER OF A-ABLE SEPTIC



2004 PETERBILT 379
THANK YOU TO BOB CAROMANO



2004 MACK VISION
5,000 GAL. TANK - THANK YOU MR. GARY
FOR YOUR GENEROUS HOSPITALITY
IN LOUISVILLE

100,000 MILE LIMITED FACTORY WARRANTY

▶ DELIVERY ▶ EXPORT ▶ PUMP WARRANTY: 1 YEAR ▶ TANK WARRANTY: 5 YEARS



DRAGON

PRODUCTS, LTD.

PUMPS DIVISION

A Modern Group Company

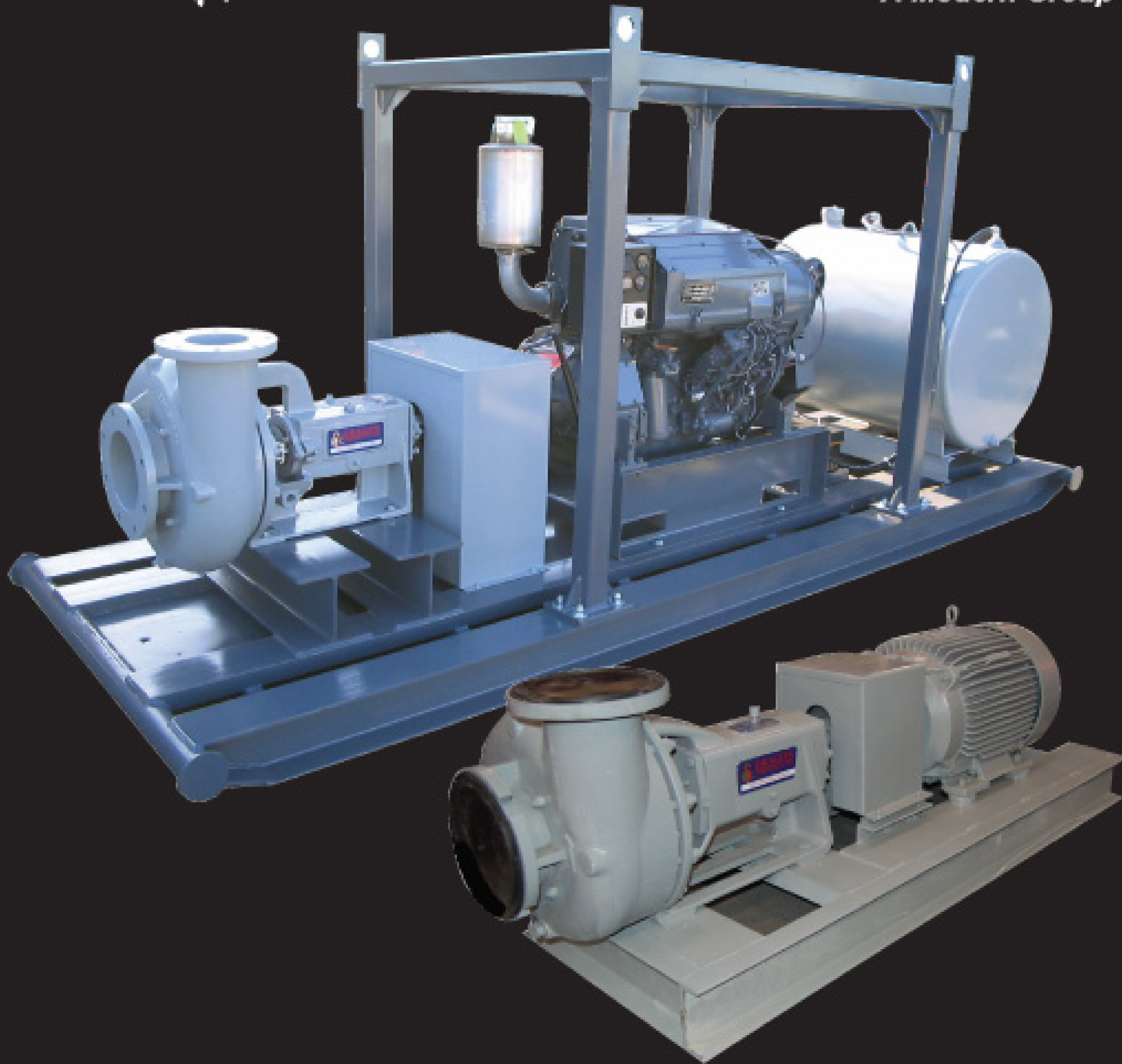

Custom fabrication to meet our customers specific needs in the Petrochemical, Shipping, Drilling, Agricultural and Mining industries. All Dragon pumps, agitators, hoppers and pump packages are assembled in Liberty, Texas.

All internal pump parts such as bearings, shafts, and mechanical seals are from the highest quality parts and materials made in the USA.

We maintain a huge warehouse of motors by Baldor and Reliance and starters by Sprecher & Schuh/Allen Bradley.

We also have a full stock of replacement parts for your pumps which are 100% interchangeable with other popular pumps on the market. Dragon is the largest stocking dealer of **Fruitland Pumps and Parts** in the U.S.A.



1-866-914-8198

email: sales@modernusa.com

website: www.modernusa.com



DRAGON

PRODUCTS, LTD.

A Modern Group Company

150 BBL ALUMINUM &
130-160 STEEL CODE
AND NON-CODE
VACUUM TRAILERS



30-80 BBL STEEL &
ALUMINUM BOBTAILS



SINGLE & TWO CONTAINER
ROLL-OFF TRAILERS



VACUUM
ROLL-OFF
CONTAINERS

500 BBL LIQUID TIGHT
SMOOTH WALL CONTAINERS



Looking for Great Deals on Quality
Used Equipment.
Check out our web-site at:
www.modernusa.com

(877)778-4280

email: sales@modernusa.com



Ask about our easy
Credit Terms and
Convenient
Financing.



Lely Waste Solutions, LLC

Temple, TX | 800 367 5359



2008 International / 2500 Gallon Aluminum Septic Unit In Stock **(POR)**



2008 F-750 / 2500 Gallon Aluminum Septic Unit In Stock **\$84,492.00 + TTL**

WE STOCK PACKING FOR **RIV VALVES**



Temple, TX
800 367 5359
Fax 254 938 7204

Bruce Curry
bcurry@lelywaste.com
Earl Ballard
eballard@lelywaste.com

VAR SINCE 1974
LIQUID WASTE
HOSE & ACCESSORIES **CO.**

BUILDING YOUR OWN TRUCK?

NEW TRY OUR VARCO "BYOT" KIT

EVERYTHING YOU NEED IN ONE KIT!

\$5,999.95

Price good through 4/30/08

FOR ONE LOW PRICE!

INCLUDED!

PUMP & VACUUM TRUCK COMPONENTS

- Jurop R260 Vacuum Pump **A**
- 12" Low Profile Primary – 3" Opening **B**
- 10 Gallon Horizontal Secondary
- 3 Shaft Right Angle Gear Box
- Jurop Final Filter w/ 3" Connections
- Pump Stand
- Aluminum Auto Align Bracket for Gear Box
- 3" Horizontal Oil Catch Muffler
- Vacuum Pressure Tree: Includes Gauges and Valves
- Pump Coupling



- 363 CFM
- 18" CONTINUOUS DUTY
- BALLAST PORT COOLING

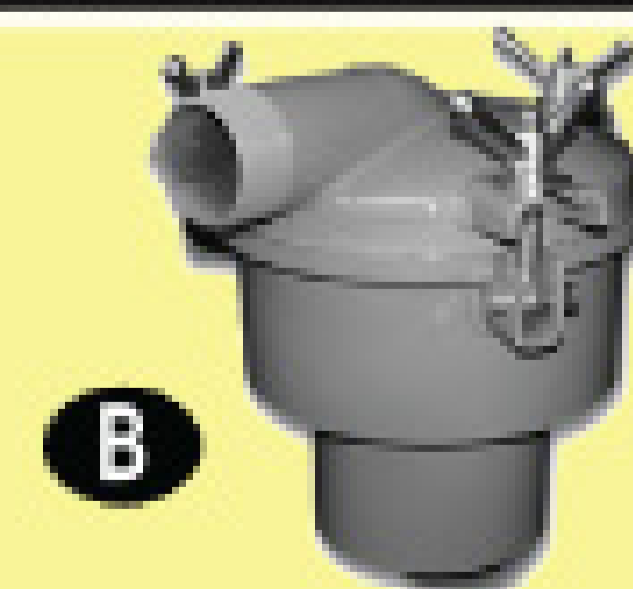

INCLUDED!

VALVES - DUMP & SUCTION

- One 3" Brass Lever Valve **C**
- One 4" Brass Lever Valve

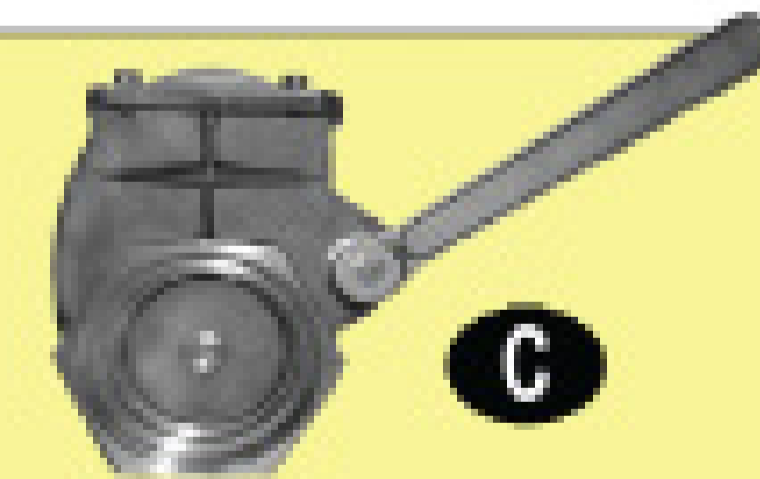

INCLUDED!

HOSE AND FITTINGS

- 4 Lengths 3" x 25' Tiger Green Vacuum Hose
- 20' of 3" Vacuum Components Hose

FREE CATALOG



SHOP ONLINE @ WWW.VARCOPUMPER.COM

TOLL FREE

866-872-1224

SOURCE KEY
4P8





VANTAGE POINTS!

When you add up the facts, there's no advantage like the Vantage!

- Reinforced corners hold their shape. No exterior molding.
- Double-walled construction for extra strength
- Smooth interior walls for quick, easy cleaning
- Waist-high strap-down guides on all four corners
- Eight huge hand-holds make handling a breeze
- Versatile parts fit other restrooms in the PolyPortables' family
- Now 14 popular colors, plus custom colors on orders of 100 or more

Flexible Financing available for a limited time

Tell us what you need: Lower payments? Longer terms? Less interest? Deferred payments? Choose the options that are best for you.

Visit us online at the new PolyPortables.com



Listening. Learning. Delivering. Since 1972

99 Crafton Drive, Dahlonega, GA 30533 USA • Phone (800) 241-7951 or (706) 864-3776 • Fax (706) 864-8111 • www.polyportables.com

Only PolyPortables offers high-performance Green Way Products

TOILET DEODORIZERS • TOILET CLEANERS • AIR FRESHENERS • INSECT REPELLANT

All Green Way deodorizers, cleaners and air fresheners are earth-friendly, people-friendly products. They are developed and manufactured in our facilities in Dahlonega, Georgia by Green Way Products, a PolyPortables sister company.



Panning For Golden Customers

Inexpensive marketing tools and concepts will help you mine valuable new and repeat business

By Joe Weber

Every company, regardless of size, has a marketing budget. Some of those budgets are large and some are small. But even if you have a limited budget, you can still produce great marketing results.

There are many opportunities to promote your company without emptying your wallet. Be creative. Look at who your current and potential customers are. Now think of ways to put your products and services in front of them and keep them thinking about you.

In many cases, purchasing decisions are based on timing. You want to be in front of that customer when it's time for them to buy. Rather than coming up with revolutionary marketing tactics and strategies, focus on relatively simple, cost-effective methods that can deliver revolutionary results: making a game plan, rubbing elbows, building your prospect list, putting yourself out there, and staying in touch.

MAKING A GAME PLAN

Always start with a plan. It will help you determine what to do, when to do it and how much it's going to cost. You can create a comprehensive sales and marketing plan on your own; there are many free resources to help. Search online for "marketing plans," or go to your local library. Some tools will be geared toward Fortune 500 companies and others designed for small companies. Take everything you gather and treat it like a big buffet line. Determine what makes sense for your business and dig in. Be

practical. Don't bite off more than you can chew. Your plan should be achievable. With no investment other than your time, you can build a marketing plan that will drive results.

RUBBING ELBOWS

People like to buy from people they know. So how do you get to know them? In most areas there are Chambers of Commerce and industry associations. By joining these groups and participating, you will begin to develop relationships with individuals who can refer you to their company's portable sanitation purchasing managers.

Don't forget about referrals. If you believe you're doing a good job, ask your customers for referrals. "Do you know any other companies that you could refer me to?" It's just a question and it doesn't cost you a penny. A local auto dealer originally from Germany built his business by asking everybody he knows, "Who do you know wants to buy a car?" His is now one of the largest dealerships in the state.

BUILDING YOUR PROSPECT LIST

Resources are available that won't break the bank. The *Yellow Pages* are a good start. You can peruse online business listings as well. These listings won't tell you the size of the prospective customer though, so try your local business journal or similar business publications. They typically print a book of lists, which contains local business resource lists such as construction companies, golf courses, and special attrac-

Rather than coming up with revolutionary marketing tactics and strategies, focus on relatively simple, cost-effective methods that can deliver revolutionary results.

tions. They also print building permits and newly awarded construction projects. If you've joined professional associations or Chamber of Commerce groups, you will have access to their lists. These resources can account for a prospect list in the hundreds.

PUTTING YOURSELF OUT THERE

Build a presence within your market and promote it. Do you have a Web site? You don't need to know programming or be a design genius to start a basic Web site. You can purchase your domain (Web address) and for a minor investment of time and money you will be up and running with your own Web site. For resources, go online and search for "Web site templates domain names." If you can't afford to hire a Web site designer, this is a better alternative to not having a site at all.

Brochures and flyers will go a long way in your promotion. Today, most of this can be done at home or in your office with a computer and printer. Templates are available online. Do a search for "free brochure templates." Quick-print shops may do free design and layout if you get the printing done at their shop. Don't let budget constraints prevent you from using these marketing tools.

Another obvious handout is your business card. They are inexpensive to print, so be liberal

Joe Weber is marketing manager for Hampel Corp., Germantown, Wis.



and hand them out to everyone you deal with. Get your name and number in your customers' and prospects' hands. Also, what do people see when they drive down the road? They see your trucks, trailers and equipment. Put your company name on your entire fleet. Get signage on everything. The more people who see your name, the more calls you'll get.

STAYING IN TOUCH

The most obvious way to stay in touch with your customers is to call or visit them. This can be time-consuming if you don't have a sales person. Postcards are an inexpensive and versatile way to stay in touch with prospects. Search online for "postcards," or try your local quick-print shops.

If your service is required once a year, flag your customers to receive a reminder mailing from you prior to their next service date. Build in an offer and get them to call you. E-mailing and faxing is economical, but should be used sparingly. When faxing, be sure you're not violating do-not-call laws. Get your customers' permission to send periodic faxes. Some people do not like to receive sales solicitation via fax and e-mail. If you use this method, try to send information that has value and not just a sales pitch. Remember, you don't always have to be selling, but keep them thinking about you. ■

TankTec

Tank Technologies & Supply Co. LLC
 Portable Restroom Service Trucks
 Septic, Grease & Grit Trucks
 Refined Fuel Trucks

2007 Sterling LT9500 **888.428.6422**

410/450 HP, 1550 TQ
 58,000 G.V.W. (18+40)
 Chrome Bumper and Stack
 10-Speed • Aluminum Wheels
 4" Inlets • 6" Dump

4200 Gallon:
 Masport HXL400 400 CFM
\$127,000 plus FET

4800 Gallon:
 Moro Storm 824 CFM
\$134,500 plus FET



2 In Stock!



Many Trucks

In Stock for
QUICK DELIVERY

Chevy 7500 Septic Trucks

2 In Stock!

From **\$77,250**



Ask About In Stock Trucks • Call for Lease Payment Details
 Tanks in Stock • Financing and Leasing Options Available • Dual-Use Options
 Customize to Your Needs • PRS 800-2500 Gallon • Vacuum 1000-6000 Gallon

2008 Sterling Acterra

Portable Restroom Service Truck
In Stock!

26,000 G.V.W.
 Automatic • Air Brakes

From **\$81,250**

Standard PRS Features:
 Masport HXL4V 160 CFM
 Vacuum Pump System
 Burks DC-10 Water Pump
 Fold Down 2 Toilet Hauler
 2 Large Work Cabinets



Tank Technologies & Supply Co. LLC • 888.428.6422 • www.tanktec.biz

Steve Nelson • snelson@tanktec.biz
 Andy Nelson • anelson@tanktec.biz

Local • 763.755.8075 • Fax • 763.757.9788
 10100 Quinn St. NW, Minneapolis, MN 55433

WHY ADDITIVES?

A STORY TOLD THROUGH DEFINITIONS

FROM WEBSTER'S DICTIONARY

Septic Tank: "an underground tank in which waste matter is decomposed through bacterial action."

What might upset this "bacterial action"? Let's look at the labels of some typical home-care products....

AGAIN FROM WEBSTER'S

Disinfectant: "a means for destroying bacteria."

Antibiotic: "having the capacity to inhibit the growth of or destroy bacteria."

Sterilize: "to cleanse by destroying bacteria."

Anti-septic: "any substance that inhibits the action of bacteria."

Anti-bacterial: "destructive to or inhibiting the growth of bacteria."

These bacteria-killers are in products that we all use every day. It's no wonder there are so many failing septic systems!

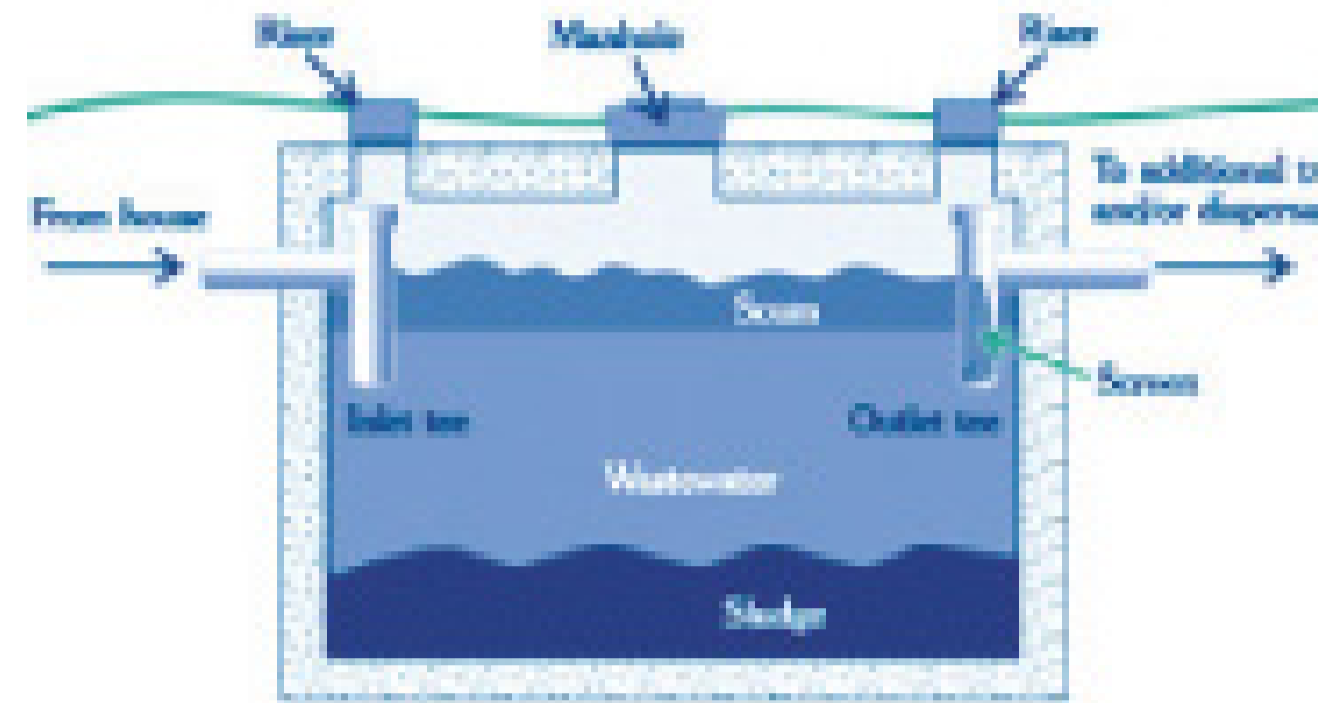

THE CLEANER THE HOME, THE DEADER THE TANK

So are we saying to stop cleaning and disinfecting the house? Of course not. What we're saying is if you're going to regularly kill bacteria needed for proper septic tank operation, you need to regularly replace those bacteria with a monthly dosage of **CCLS**, "The Original" bacterial additive.

CCLS contains billions upon billions of the exact right, laboratory-enhanced bacteria to balance your septic tank and keep it running properly. **CCLS** is USDA-Approved, and has been used in households like yours since 1976.

For more information on the **CCLS** family of products for septic systems, grease waste systems, sewer and drain lines, for restoring drainage, and for portable restrooms, call us toll-free at 1-800-759-2257. We'll send you our product information packet, including prices and all our sales and customer education materials. Please call today. Thank you.

-Rick Howe, President

BIO-REM-ED

DrainMaster

ccls®

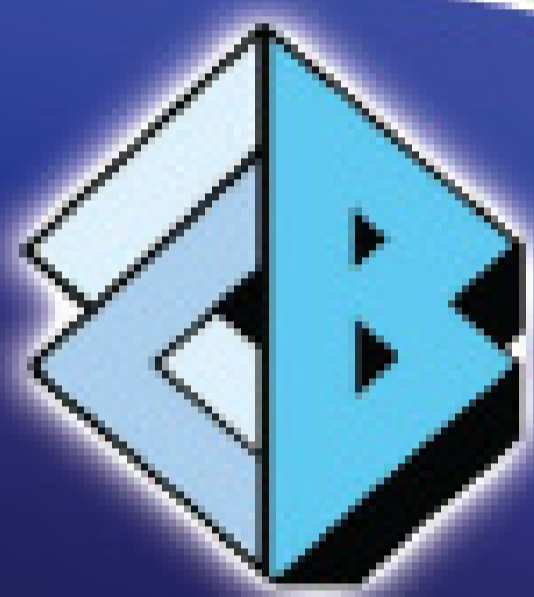

CAPE COD
BIOCHEMICAL
COMPANY

P.O. BOX 990 • POCASSET, MA 02559

1-800-759-CCLS

WWW.SEPTICONLINE.COM

PARTNERS WITH
SEPTIC PROFESSIONALS
SINCE 1976

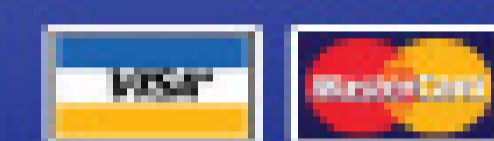

FAX: 508-564-9974



GET MORE JETTER
FOR YOUR DOLLAR!



STB2511H-MAX

Full Featured Jets with Powered Reels:

SK4007V 23 h.p. Briggs 7GPM @ 4000 PSI... \$9950

STB2511H 24 h.p. Honda 11 GPM @ 2500 PSI... \$11699

SK3012K 29 h.p. Fuel Injected Kawasaki 12 GPM @ 3000 PSI... \$13995

STB2020V 35 h.p. Briggs 20 GPM @ 2000 PSI... \$19699

STB4018DT 49 h.p. Hatz Quiet Diesel 18 GPM @ 4000 PSI... \$39950

Trailer Models starting at \$7499

www.camspray.com

800-648-5011

CADMAN / ALBERS

For Emergency or Temporary Storage of Liquids



- Safe, affordable enclosed storage.

- Up to 1.3 million U.S. gallons of capacity.



- Various agitator options.

- Neighbor friendly odor control.

- Blends in with the surroundings.

We also offer fully portable, transportable systems. Your containment solution is only a phone call away.

Cadman
POWER EQUIPMENT
AGRICULTURAL MACHINERY
& IRRIGATION EQUIPMENT

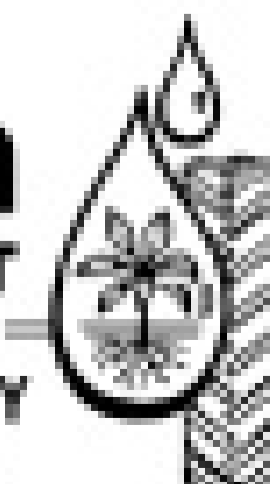

38 Main St. • Courtland, Ontario, Canada

1-866-422-3626

www.cadmanpower.com

Experience Matters.

Custom vacuum tanks built to your specifications.

For nearly 50 years, our tank builders have been setting the industry standard for innovation and value. Everything we build is customized to your exact specifications. Start with a bare tank and add only the options that are suitable for your application. What about service? Our technicians can rebuild pumps or furnish parts such as vanes, seal kits, housings, and rotors for most pumps. Whatever you need, let us put our experience to work for you.



Bare tank w/no attachments

Bare Tank:

Prices are for the tank only with no openings, hatches, rails or other attachments. LMT can furnish items for you to attach to your tank at additional cost. Please call for more information and pricing.



Basic tank w/optional manway and hose trays

Basic Tank:

Prices include primary shutoff, full length rails (straight or tapered), 4" discharge nipple, and 3" intake nipple.

Check out some of the options:

- ✓ Manways (20", 25", 36")
 - ✓ Full open door (2 types)
 - ✓ Primary & secondary shutoffs
 - ✓ Valves for loading & unloading
 - ✓ Oil catch mufflers
 - ✓ Suction hose & couplings
 - ✓ Mounting rails & kits
 - ✓ Vacuum pumps (Jurop, Masport, Moro, Fruitland, and others)
 - ✓ Hose trays and hangers
- And more...

LMT Basic & Bare Tank Prices:

(subject to change without notice)	Basic Tank	Bare Tank
1500 gallon: 54" dia. x 12' long w/1 baffle.....	\$ 4,345.....	\$ 2,958
2000 gallon: 60" dia. x 14' long w/2 baffles.....	5,406.....	4,037
2500 gallon: 66" dia. x 14' long w/2 baffles.....	6,145.....	4,753
3000 gallon: 68" dia. x 14' long w/2 baffles.....	7,162.....	5,728
3500 gallon: 72" dia. x 17' long w/2 baffles.....	8,660.....	7,138
4000 gallon: 78" dia. x 16' long w/2 baffles.....	9,784.....	8,226
4200 gallon: 78" dia. x 17' long w/2 baffles.....	10,272.....	8,689

Custom sizes up to 6000 gallon are available.

All lengths are can length excluding flanged and dished ends. All tanks over 70" dia. have 2 braces of 2" x 3" solid steel to prevent collapse of tank. All tanks are cleaned with an acid solution and prime painted. We can also customize the paint color for an extra fee. Tanks are manufactured with mild steel and are welded with submerged arc process for the best strength and appearance. Stainless steel is available at extra cost.



Call us at 800-545-0174 before you buy!

LMT Inc. - Custom Vacuum Tanks

Tel: 309.932.3311 • Fax: 309.932.3155 • info@tanksandpumps.com
www.tanksandpumps.com

About that article,
would you like a copy?

A poster to display in your office?

An electronic file to post on your web site?

Reprints to hand out or mail to potential customers?



Just let us know!

Pricing and options available by
e-mailing sherryd@colepublishing.com
or by calling 800-257-7222

Summaries of past articles at pumper.com

Pumper.

Choice. We offer **MORE** than all the others combined.
 More choices of exteriors - *these are just a few!*



More choices of interiors - *many more online.*



Restroom Trailers | Shower Trailers | Combination Shower /
 Restroom Trailers | ADA Trailers | Decontamination Trailers
 Hand Wash Trailers | Drug Screen and Lab Trailers

Visit our Online Catalog - www.ameri-can.com

More Choices...

- 75 floorplans to choose from
- Wide range of exterior designs
- Choice of 9 unique interiors or design your own
- More Features
- More Options
- More Functionality
- More value for your investment

AMERI-CAN
ENGINEERING
 15886 Michigan Rd | Argos, IN 46501
574-892-5151

100% FINANCING AVAILABLE

• **No Financials Required**

Application Only to \$250K

• **No Age Restrictions**

Used Equipment (30+yrs still ok)

• **Seasonal Payment Plans**

- Bucket Machines
- Dewatering/Composting
- Trailer Mounted Combo
- Cable Machines
- Hydro Excavators
- Sweepers
- Catch Basin Cleaners
- Jetters
- Vacuum Loaders
- and much more.....*
- Combo Sewer Cleaners
- Liquid Vacuum Trucks

• **Working Capital**

Start-Ups Welcome

• **Sale Leasebacks**

Simple One Page Application

• **Private Party Sales**

ACG IS A FULL IN-HOUSE LENDER. OUR TEAM OF PROFESSIONALS PROVIDE SAME-DAY DOCUMENTATION AND FUNDING. LET US STRUCTURE A PROGRAM THAT BEST FITS YOUR BUDGET WITH INSTANT CREDIT DECISIONS. LESS THAN PERFECT CREDIT (FICO 580+) IS APPROVABLE!

Your Pumper Team!

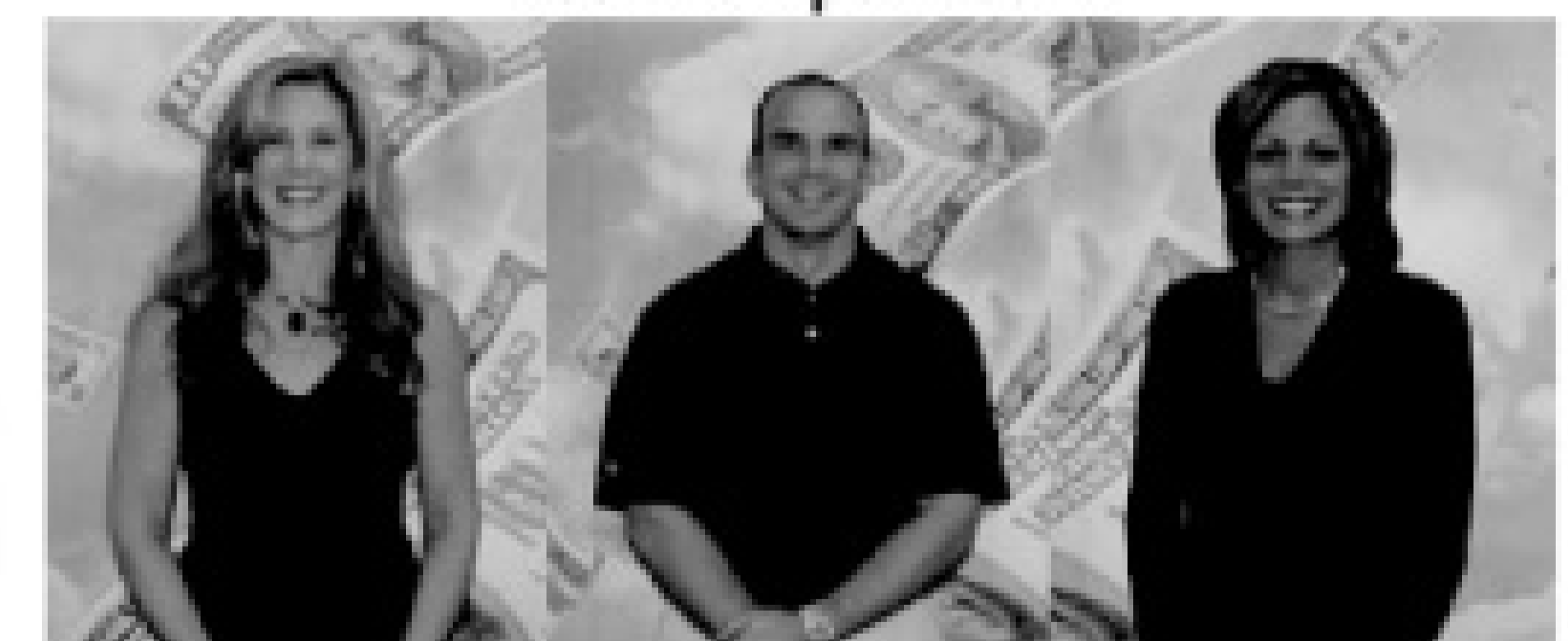

Cindy

Bryan

Ronnie

For details call: **440-579-0414**

9436 Hamilton Dr. • Mentor, Ohio 44060 • Fax 800-830-9855 • www.1acg.com



**Appearance
Performance
Quality
Since 1939**

Conde PowerPaks

More Power To You

**Conde gas powered vacuum units
are compact, powerful, and
ready to install for instant vacuum**

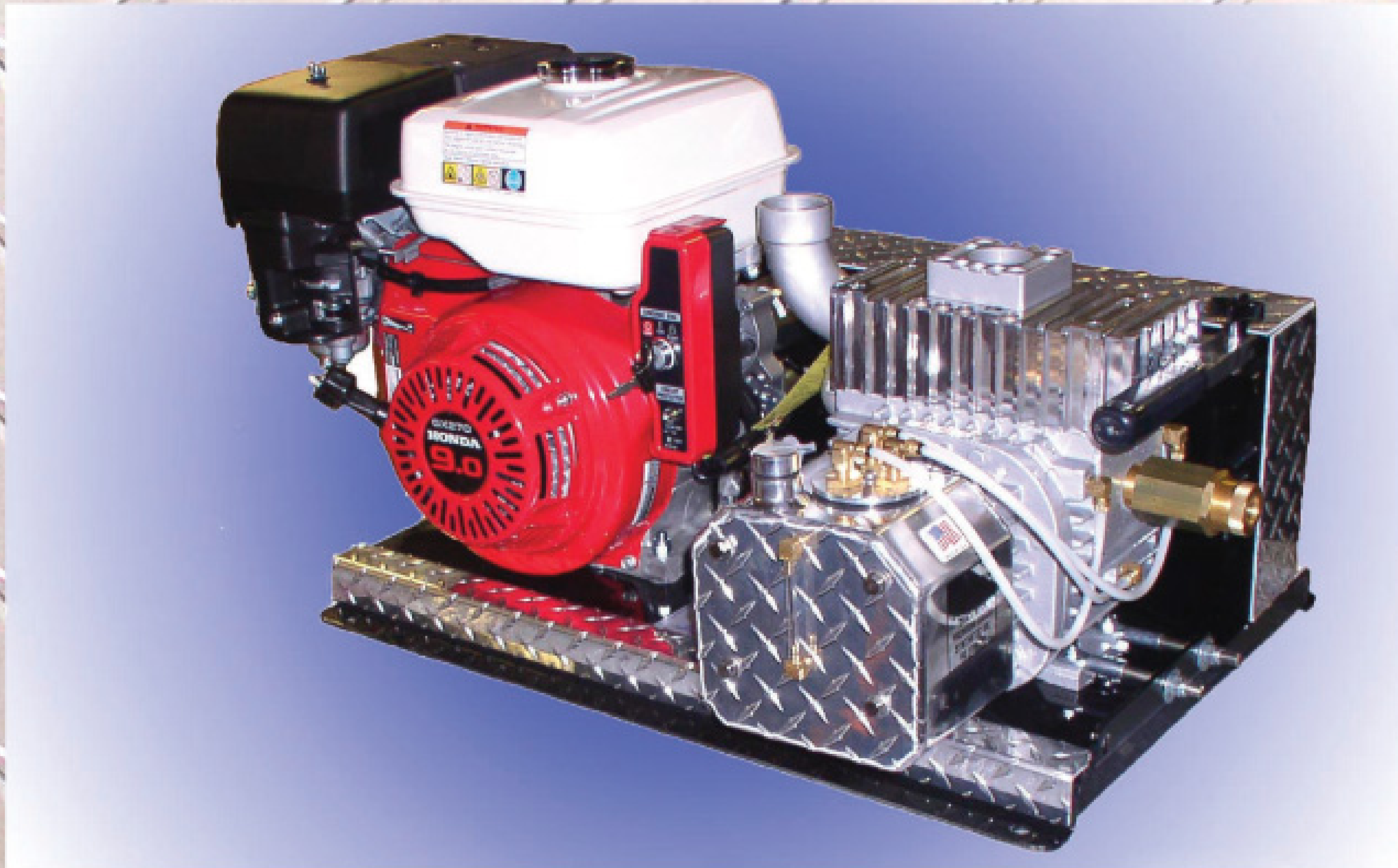

Westmoor Ltd.

P.O. Box 99
Sherrill, New York 13461

Call Toll Free 1-800-367-0972

On The Web At: www.westmoorltd.com E-mail: pumps@westmoorltd.com



VSI Vacuum Sales Inc.

51 Stone Rd. | Lindenwold, NJ 08021

888-VAC-UNIT | 888-822-8648 | Fax: 856-627-3044
E-mail: vsisales@aol.com | www.VacuumSalesInc.com

NEW EQUIPMENT CUSTOM BUILT TO YOUR SPECIFICATIONS



(8734V) **1998 International 4700** with a 1,500 U.S. gallon, 2-compartment (1100/400 split), Carbon Steel; portable toilet service unit.



(2104V) **1999 Freightliner FL60** with a 1,000 U.S. gallon waste, 250 U.S. gallon water; 250 U.S. gallon mix; 3-compartment, Stainless Steel vacuum tank, with a NVE 184 vacuum pump and washdown system.



(13294) **2008 Sterling LT9500** triaxle with a new Presvac, Powervac 3800, 3,250 gallon (US), DOT, wet/dry industrial, vacuum tank loader



(13289) **New Presvac 2,000** U.S. gallon 2-compartment (1500/500), Aluminum vacuum tank, with a Moro M3 vacuum-pressure pump installed on a 2007 Chevy C7500 Cab and Chassis.



(13273A & B) **2-2007 New Acro Trailers** New Acro 7,000 U.S. Gallons Aluminum vacuum pressure tanks



(13281B) **2007 Sterling LT9500** new Presvac, Powervac 3800, 3,250 gallon DOT, wet/dry industrial, vacuum tank loader.



(13329V) **2001 Freightliner C120** can and chassis with a new Presvac 3,200 gallon DOT 407/412 Certified Vacuum - pressure tank.



(13317) **New PipeHunter Model 38T44 Jetting unit** Trailer mounted unit, w/ 335 Poly water tank 4,000 psi @ 25 gpm, 600 ft of hose and attachments.



(13297A) **2007 Peterbilt 340** with a Presvac 3,600 gallons (US), aluminum vacuum tank unit.



(5008V) **1990 Presvac 5,000** stainless steel D.O.T. with pump engine.

We've Got You Covered

Whatever you need in ground protection mats

AlturMATS

Toughest mat in the industry. Supports 60 ton vehicles.

VersaMATS

Perfect for vehicle or pedestrian traffic.



Unique waffle tread. Slightly lighter weight.

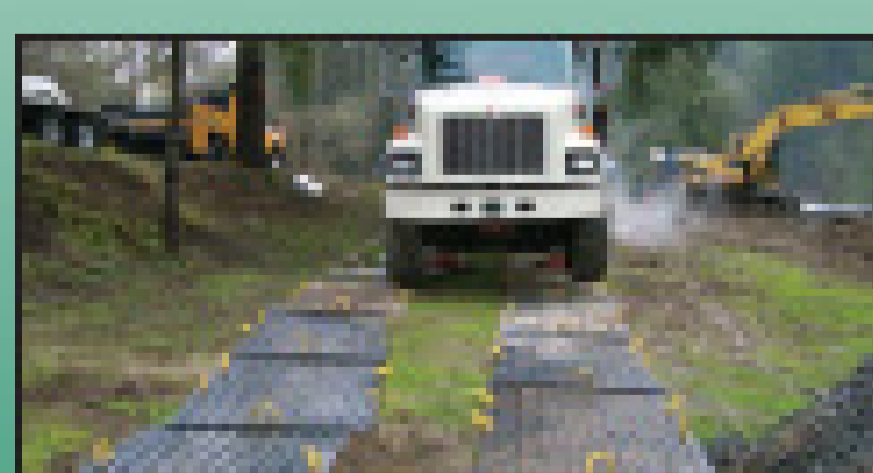

AlturMATS continues as the world's largest producer of quality ground protection mats.

Call for the name of your nearby dealer: 888-544-6287

AlturMATS®

sales@alturmats.com

www.alturmats.com



One-Piece Plastic Outrigger Pads Available in a variety of sizes.

CLEAR COMPUTING with INSIGHT

Total Activity Control Street Eagle GPS

Switch Now!

- Profit by Work-Order
- In-Vehicle Garmin Updates
- GPS Vehicle Tracking
- FREE Imports

1988 - 2008

20

YEARS OF EXCELLENCE

Call Today!

Try it Yourself Free...

On the Web or Your PC



Clear Computing
(888) 332-5327
www.clearcomputing.com

Insight USA
(301) 866-1990 x201
www.mds-inc.com

Supplying your Business for Seasons of Success



- **One-Stop Shopping**
Our wide selection of products makes shopping at several different places for all of your needs a thing of the past.
- **Very Competitive Pricing**
- **Huge Selection**
We carry a wide selection of portable restroom parts and accessories to take care of all your needs. Including toilet parts, pumps, pressure washers, hoses, valves, fittings, tank components, chemicals, dispenser systems, hand sanitizer, deodorizers and odor control products, engines, sink parts, cleaning supplies, and much much more.
- **Two Locations for Faster, More Economical Shipping**
Our warehouses in Utah and Georgia are strategically placed to service every state.
- **Custom Pump Trucks**
If you can imagine it, we can build it. We pride ourselves on our ability to work with our customers and design an efficient and effective pump truck designed around your custom applications.



**CALL TODAY for your
FREE product catalog!**



1-888-935-1133

www.toico.com

YOUR ONE STOP SOURCE FOR PORTABLE RESTROOM PARTS AND SUPPLIES

T&T TOOLS

T&T TOOLS, Inc.

FAX: 800.521.3260 | EMAIL: sales@TandTtools.com

800.521.6893

www.TandTtools.com

CALL FOR A FREE CATALOG!

CALL FOR A FREE CATALOG!

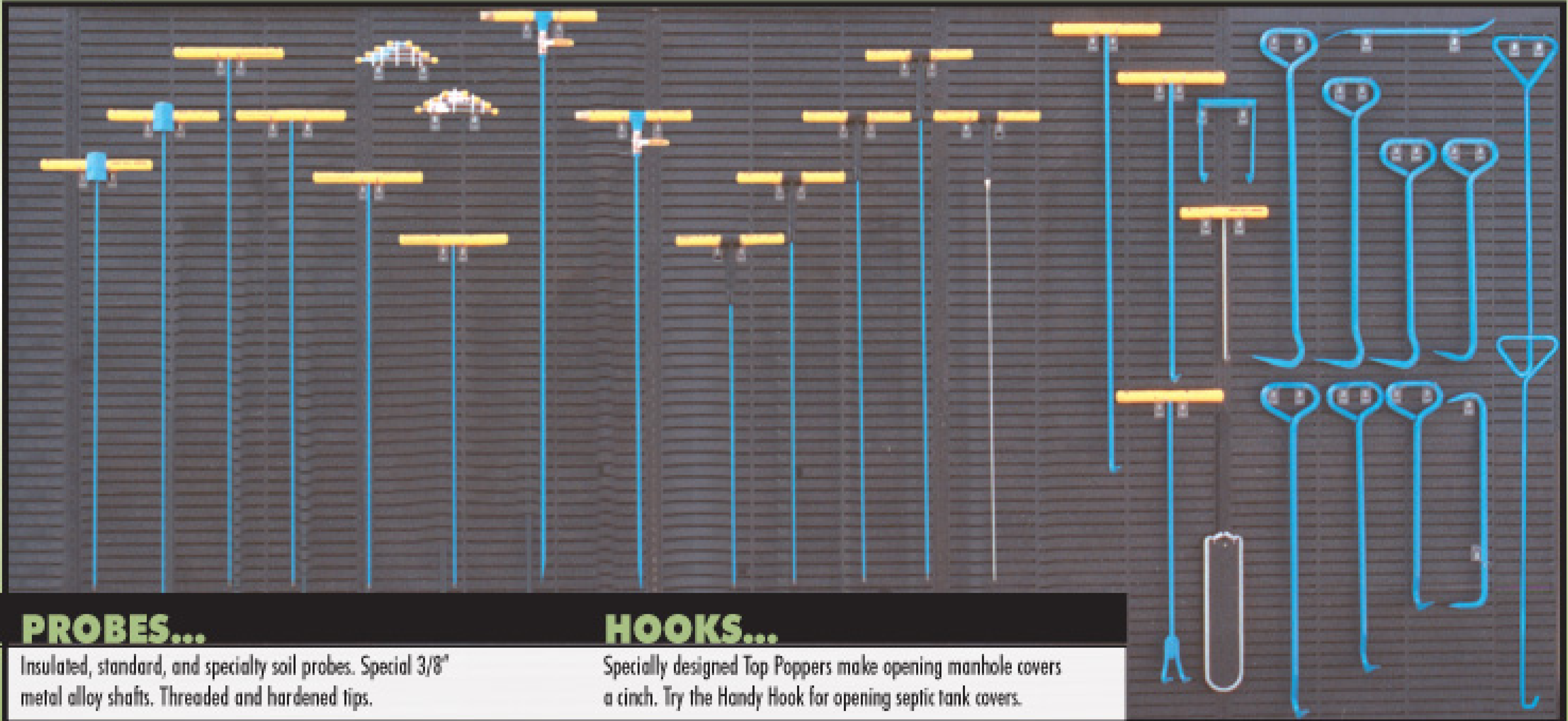

PROBES...

Insulated, standard, and specialty soil probes. Special 3/8" metal alloy shafts. Threaded and hardened tips.

HOOKS...

Specially designed Top Poppers make opening manhole covers a cinch. Try the Handy Hook for opening septic tank covers.

WE'VE GOT DRESSER ROOTS BLOWERS AND A LOT MORE

The Dresser Roots blowers are the finest truck mounted units available today. And, as a factory authorized sales and service center we're here to provide the best support for all your blower applications.

We're also here to help with your vacuum equipment repairs, rebuilding, and replacements that also includes our special blower exchange program.

Just give us a call.

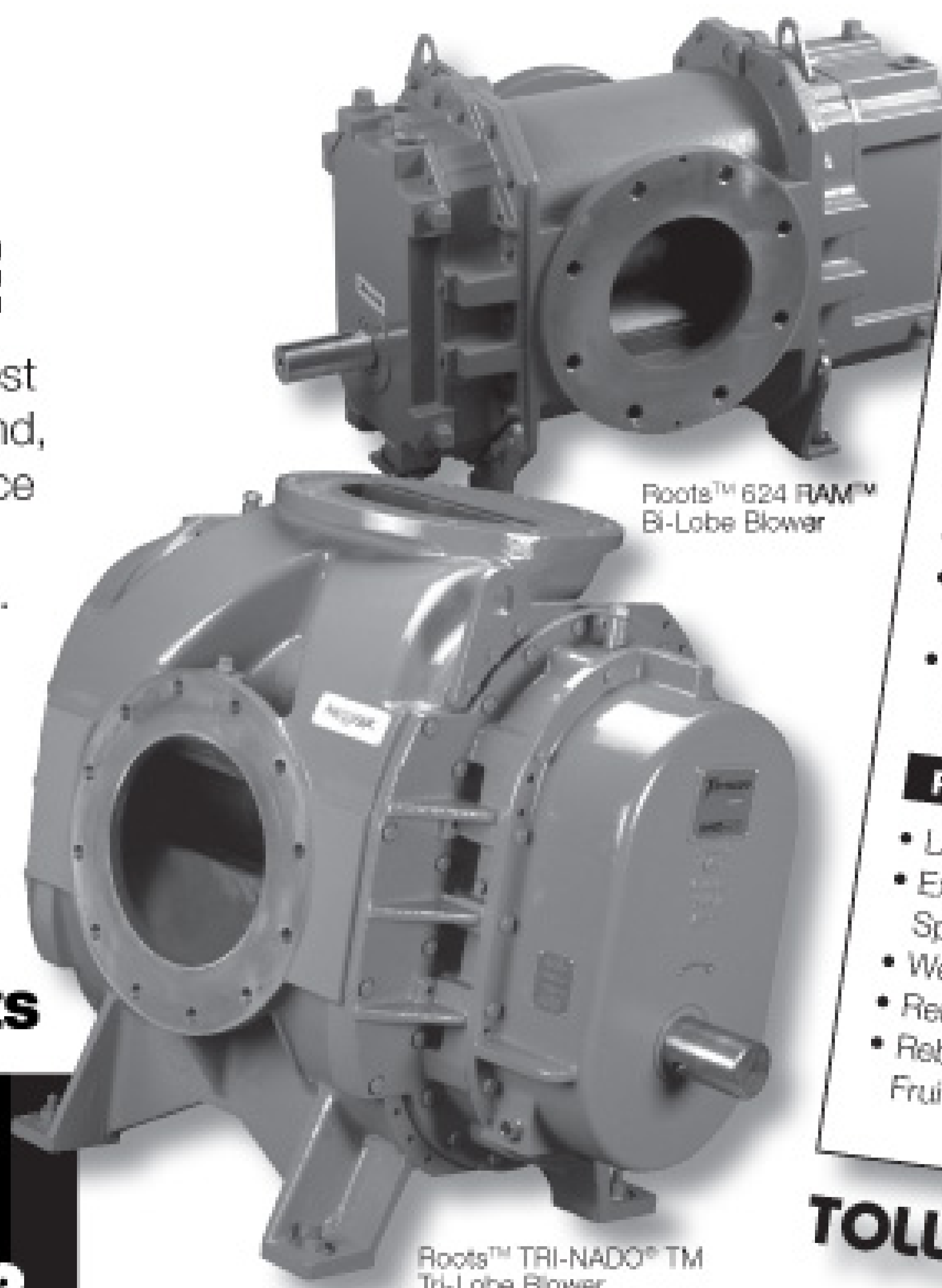

Roots™ 624 RAM™ Bi-Lobe Blower

Roots™ TRI-NADO™ TM Tri-Lobe Blower

VACUUM PUMPS, TRUCKS & ACCESSORIES

- Aquatech** • Sewer trucks & equipment
- Conde** • Toilet truck vacuum pumps
- Hi Vac** • Industrial vacuum systems
- Metaltecnica** • Valves & accessories
- O'Brien** • Sewer cleaning jettors
- Presvac** • Septic & sewer trucks
- Roots** • Bi-lobe & tri-lobe vacuum blowers
- Stoddard** • Intake filters & discharge silencers
- World-Tech** • Sewer cleaning nozzles & valves

COMPLETE FABRICATION & MACHINE SHOP

- 24 Hour service
- Custom built blower and pump vacuum/pressure packages: electric, gas, or diesel
- Custom parts fabricated or reconditioned including bearings, shafts & sleeves

REBUILD SPECIALISTS

- Largest blower repair center in the Universe.
- Experts in rebuilding blowers: Roots, Sutorbilt, Spencer, and Hibon
- We rebuild all vacuum pump makes and models
- Rehab sewer cleaning trucks and equipment
- Rebuild kits in stock for Schult, Wittig, Moro, Jurap, Fruitland, and Challenger

TOLL FREE: (800) 359-PUMP

Orlando, FL: 800-359-7867 • WWW.PATSPUMP.COM • Atlanta, GA: 800-851-7987

**YOUR CHOICE OF:
STEEL, ALUMINUM OR
STAINLESS TANKS!**



**IMPERIAL
INDUSTRIES INC.
800-558-2945**

**WE DIDN'T JUST INHERIT THE NAME "IMPERIAL",
WE EARNED IT WITH "IMPERIAL" QUALITY/DESIGN/SERVICE**



"SPRING SPECIALS" IN STOCK AND READY FOR DELIVERY!

• New 2006 Sterling/3600 Gallon Steel Tank \$111,192.00 W/FET

• New 2008 Blue I.H./3600 Gallon Steel Tank \$130,930.00 W/FET

• New 2008 Sterling/3600 Gallon Steel Tank \$120,773.00 W/FET

• New 2008 I.H. Automatic/4000 Gallon Aluminum Tank \$139,975.00 W/FET

Call **Jim Stieber** or **Brad Rybarczyk** for details!

"SPRING SPECIALS" IN STOCK AND READY FOR DELIVERY



• New 2005 GMC Tilt Cab/2150 Aluminum Portable Service Unit, \$ 70,000.00

• New 2008 Ford F550 Auto 4x2/1100 Gallon Aluminum Portable Service Unit \$59,998.00

• New 2008 Ford F550 Auto 4x2/1100 Gallon Aluminum Portable Service Unit \$63,294.00

• New 2008 Dodge 4x2 Auto/700 Gallon Aluminum Sidewinder/Deck/Lift \$60,944.00



V&H AUTOMOTIVE
Marshfield, WI 54449
Randy Tischendorf

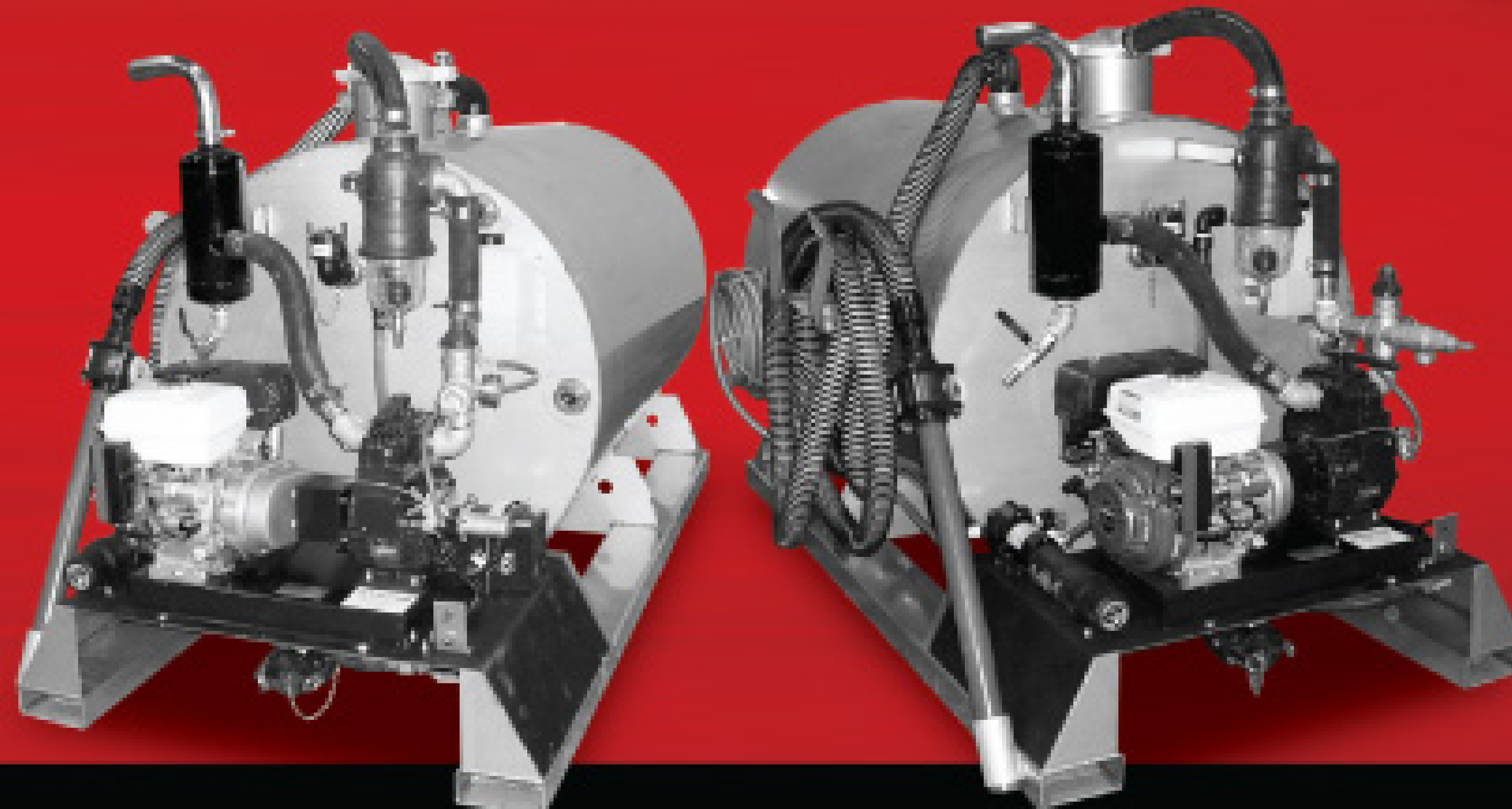

IMPERIAL
P.O. Box 1685 • Wausau, WI 54402
Tom Aerts

800-722-7382, ext. 244

www.imperialind.com

800-558-2945, ext. 317

Vermont Revises Rules to Allow Broader Use of Onsite Systems

By **Scottie Dayton**

The Vermont Agency of Natural Resources has revised onsite rules to allow constructed wetlands, sub-surface drip distribution systems and smaller onsite systems. Previously, design flows for single-family homes had to accommodate at least three bedrooms. The design requirement is now a minimum of two bedrooms.

The rules also waive the replacement drainfield requirement if the primary system handles 150 percent of the design flow and uses pressure distribution. Mound systems also do not require a replacement area if sized for 100 percent of the design flow.

The previous rules did not

mention composting toilets, although they have been allowed for years. The revisions specifically allow composting toilets, reduce the size of the onsite system to handle just gray water, and eliminate the requirement to install an onsite system for flush toilets even though composting ones are proposed.

A new exemption allows residences with outhouses or outdoor water pumps to continue as is until they apply for a permit to construct a piped supply or system. Vermont's rules are at www.anr.state.vt.us.

VIRGINIA

New rules requiring mandatory licensing of onsite soil evalu-

ators, installers and providers become effective July 1, 2009. Licensing will fall under the Department of Professional and Occupational Regulation, which has created a board to determine the type of training or certifications required.

K.R. Davis' Coastal Plains Environmental Group manages, operates and maintains small-flow alternative wastewater treatment systems. His company's lobbying on behalf of licensing resulted in Gov. Tim Kaine appointing Davis to the regulations board. Contact him at 804/966-9190 or krdavis@cpeglc.com.

PENNSYLVANIA

The state Department of Environmental Protection filed a petition in Commonwealth Court to enforce a 2002 order requiring Cromwell Township to provide public sewers and operate the treatment plant. Malfunctioning onsite systems are causing the township's problems.

When the township received sewer bids that exceeded initial estimates and would have raised user rates, it signed an agreement to send sewage to the Orbisonia-Rockville Joint Municipal Authority. The DEP approved the plan, but newly elected township supervisors repealed the ordinances.

"Rules and Regs" is a monthly feature in Pumper. We welcome information about state or local regulations of potential broad interest to onsite contractors. Send ideas to editor@pumper.com.

MISSOURI

The state Department of Health and Senior Services Onsite Sewage Program is updating its inspection and evaluation forms to allow better assessment and reporting of the condition of onsite systems. The agency will phase in the forms over six months, and conduct mandatory training classes for inspectors and evaluators. The training will qualify for continuing education credits. The phase-in period is expected to conclude in July 2008. After that, no old forms will be accepted.

NATION

The Water Environment Research Foundation has completed the first research phase for responding to reports of illness possibly caused by land-applied biosolids, animal manure, food residuals, septage and compost.

The investigation procedure will undergo pilot testing and refinements before being implemented, but organizations or individuals may use it before the subsequent research phases are completed. The project was the highest ranked priority at the 2003 WERF Biosolids Research Summit. Download the report at www.werf.org. ■



(800) 800-7575

(713) 675-7575 • Cell (713) 539-0055
Houston, TX
710 McCarty Drive • Charlie McDaniel

See Our Inventory: www.amigotruck.com

2004 MACK VISION CX613

- New Cusco 70 barrel D.O.T. certified vacuum, full opening rear door, hydraulic dump, Moro PM100 460 cfm pump, vibrator, double frame, Mack E7 Engine; 350 hp; 10 Spd Transmission; Over Drive; Camelback Suspension; 4.64 Ratio; All Steel Wheels; 240" Wheelbase; Tandem Axle; Stk #: 6247; Call for Price



2003 MACK CH613 - New Cusco 70 barrel D.O.T. certified vacuum, full opening rear door, hydraulic dump, Moro PM100 460 cfm pump, vibrator, double frame, clean truck, Mack E7 Engine; 350 hp; 10 Spd Transmission; Over Drive; Camelback Suspension; 4.64 Ratio; All Steel Wheels; 239" Wheelbase; Tandem Axle; Stk #: 6288; Call for Price

"Heavy Duty Headquarters"

Everyone's talking about it.

Find out why.
Get your **FREE** subscription today.

ONSITE
installer

PROMOTING WASTEWATER TREATMENT
QUALITY AND PROFESSIONAL EXCELLENCE

Visit www.onsiteinstaller.com or call 800-257-7222.



Our **VALUE** goes deeper than you realize.

When it comes to portable sanitation solutions, WALEX delivers much more than blue deodorizers and accessories. We're giving you **innovative research & development** that has set all the current standards for excellence. You're getting **proprietary breakthroughs** that our competitors can only emulate. When you choose WALEX, you're not only getting **the best on the market today** — you're also supporting your industry's future.



For more information, contact us at 910.371.2242, toll-free 800.338.3155
or visit our website at www.walex.com.

HOSE & HOSE ASSEMBLIES

Celebrating 57 Years

FEATURING QUALITY
HOSE AND COUPLING PRODUCTS BY:



Kanaflex



GOODYEAR

PLASTIFLEX



tigerflex

O.E.M. INQUIRIES INVITED!

MANUFACTURED TO YOUR EXACT HOSE NEEDS BY THE LEADING SOURCE IN HOSE FABRICATION

OVER 20 DIFFERENT TRANSFER HOSE CONSTRUCTIONS AVAILABLE

CALL US TODAY FOR A PROMPT QUOTE OR CATALOG

1-800-852-1855 FAX: 847-952-0156

e-mail: sales@pumperhose.com

NEXT DAY
SHIPPING AVAILABLE
FOR ALL
STOCK ITEMS

ABBOTT RUBBER COMPANY, INC.

1700 NICHOLAS BLVD. ELK GROVE VILLAGE, IL 60007 www.pumperhose.com

Portable Sanitation & Septic Pumper Supply

Spring BLOW OUT!

Dispensers
.99¢

AREN'T YOU TIRED OF:

- Bulky dispensers that clog & leak?
- Constantly changing out bag-in-the-box cartridges?
- Wondering why your profits are going down the drain?
- Products that leave skin feeling dry and irritated?

STOKO SPRAY PRODUCTS AVAILABLE EXCLUSIVELY THROUGH L.W.I.

Stoko Spray Dispenser - .99¢

Stoko Spray 400ml Moisturizing Soap
- \$61.20 (12 Refills)

Stoko Spray 400ml Instant Hand Sanitizer
- \$76.40 (12 Refills)



Liquid Waste Industries, Inc.
2962 Mt. Tabor Church Road
Dallas, Ga 30157
Phone: 877-445-5511
770-424-5575
Fax: 770-424-5536

STOKO
SKINCARE



Same Day Shipping on Orders Received Before 3:00 pm EST.



Call Toll Free **877-445-5511** • Or Visit www.lwiinc.com

Portable Sanitation



Advanced designs for 2008
to improve the bottom line!



routetrux



supertrux

Photomicrograph of
galvanized coating

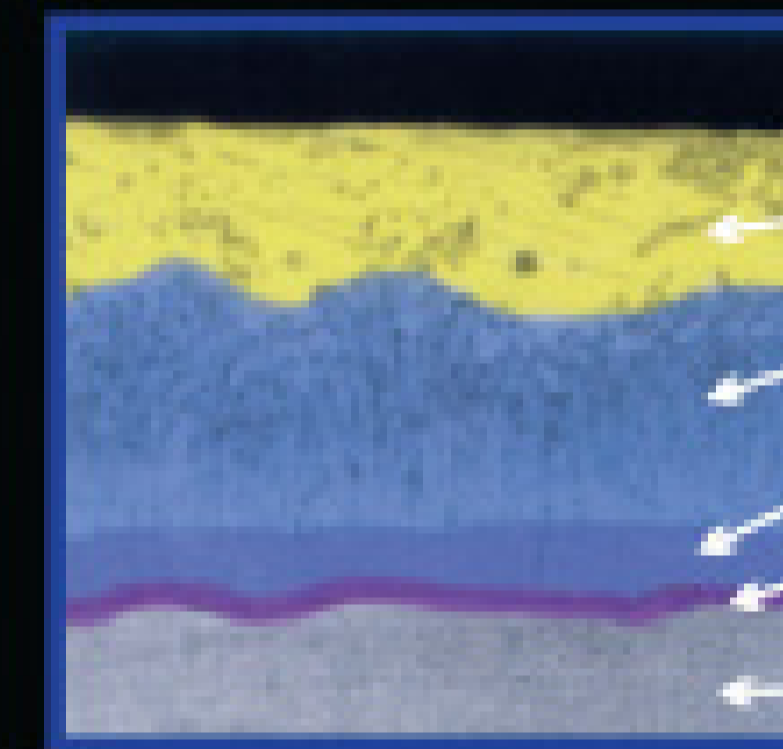

- Eta layer
- Zeta layer
- Delta layer
- Gamma layer
- Base layer

Our sanitation equipment is hot dip galvanized
for long term corrosion resistance and reliability!



pick-up-trux



maxitrux

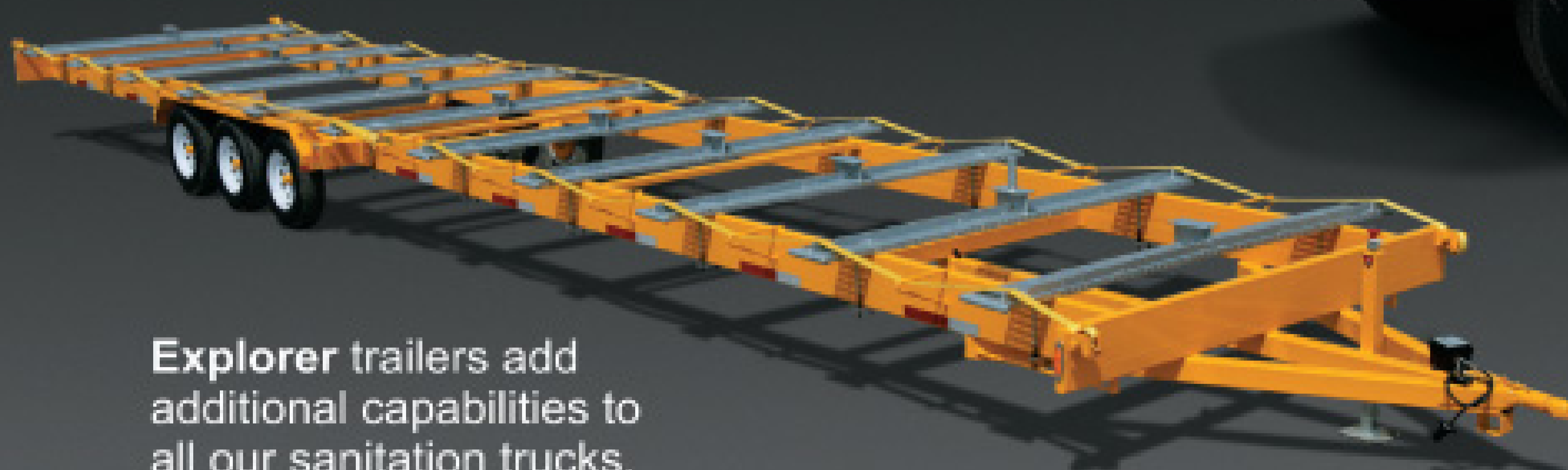

Explorer trailers add
additional capabilities to
all our sanitation trucks.

vacutrux

53 ARTHUR ST. ELMIRA, ONTARIO, N3B 2Z7
phone (800)-305-4305, (519) 669-1625
fax (519) 669-8331 salesinfo@vacutrux.com

Get More Income with Every Tank Pumped!

With **PRO-PUMP**

The Finest Name in Biological Products for Septic Systems, System Recovery, Odor Elimination and More...

Introducing New **PRO-PUMP/SEPTIC SAVER!**



SEPTIC SAVER

PRO-PUMP/SEPTIC SAVER is a combo pack of our two best selling septic treatments: **PRO-PUMP/HC & SP** packets, bundle packed as a monthly (12) treatment program.

- Septic System Treatment
- Absorption System Recovery
- Aerobic System Treatment
- Drain & Grease Traps
- Solids Reduction
- Odor Control
- Bio-remediation

The Best Microbial Technology Available Today!

The **PRO-PUMP** biological series is designed to meet a wide range of on-site wastewater applications with unmatched performance!

Want to earn more income per truck per year? BECOME A PRO-PUMP DISTRIBUTOR!

Professional Sales Materials & Technical Support at No Charge!

We provide technical support, combined with informative sales and marketing materials, and we don't sell direct to the consumer! All web-based inquiries are sent to you!

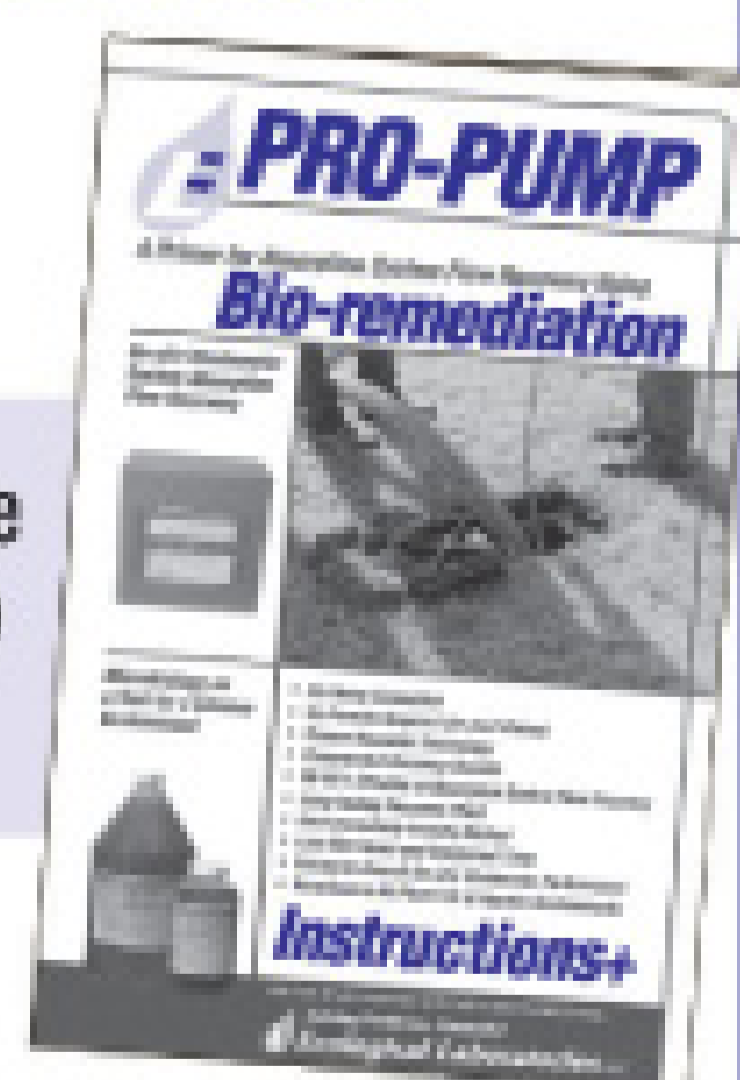

Solving Problems, Naturally!

Ecological Laboratories INC.

CORPORATE OFFICES: 13 Hendrickson Ave., Lynbrook, NY 11563

TOLL FREE: 1-800-326-7867 • FAX: 516-823-3440 • EMAIL: info@propump.com

Visit our web site at: www.propump.com

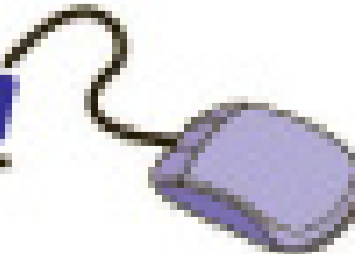

DML2000

The best Magnetic Locator on the market

- Easily pinpoint buried septic tanks, water valves, water meters, survey pins, iron pipes ...
- All weather operation; -20° to 120° F
- Works great in rain, sleet or snow.
- Waterproof Sensors; base of electronics to the crutch tip.
- Comes with a Hard Plastic carrying case or a soft-padded case.
- USA Bluebook P/N: 64978
- Best warranty in the business, a **LIFETIME WARRANTY**

Dunham & Morrow Inc.
43676 Trade Center Pl., Suite 145
Dulles, VA 20166 703-661-2144

www.magneticlocator.com

Steel Tanks



- Polished Aluminum Skirting and Tool Boxes
- 2008 GMC 5500 Duramax, Diesel, Allison Automatic Transmission, 19,500 GVW, 1000 waste, 350 fresh **\$59,000**
 - 2008 Ford, 6.4 Diesel, Automatic, 19,000 GVW, 950 waste, 300 fresh **\$57,000**
 - 2008 Dodge 5500, Cummins Diesel, Aisin Automatic, 1000 waste, 300 fresh, 19,500 **Now Available**
 - 2007 Isuzu or W5500, Diesel, Automatic, 17,950 GVW, 750 waste, 300 fresh **\$55,500**

Aluminum Tanks



by Amthor 5/16" Thick

- 2008 GMC 5500 Duramax, Diesel, Allison Automatic, 19,500 GVW, 1000 waste, 400 Fresh **\$67,500**
- 2008 Ford, 6.4 Diesel, Automatic, 19,000 GVW, 1000 waste, 400 Fresh **\$65,500**
- 2008 Dodge 5500, Cummins Diesel, Aisin Automatic, 19,500 GVW, 1000 waste, 400 Fresh... **Now Available**
- 2007 International DT-466, Air Brakes, Automatic, Under CDL, 1500 waste, 500 Fresh **\$80,500**
- Any Brand Truck Available
- Used Septic and Toilet Trucks Available



Portable Restroom Trailers

Dodge Trucks Coming Soon Check Our Prices.

8 RESTROOM | 10 RESTROOM | 12 RESTROOM | 14 RESTROOM | 16 RESTROOM | 20 RESTROOM

SLIDE-IN UNITS & USED TRUCKS AVAILABLE / MASPORT, JUROP & CONDE VACUUM PUMPS
CHECK OUR PRICES

LANE'S VACUUM TANK, INC.

3133 VANZORA RD. • BENTON, KY 42025

800.592.3308 • 270.527.9945

We stand behind our trucks and trailers!



VAC-CON

PRE-OWNED EQUIPMENT

MORE POWER TO YOU



2004 VAC-CON V390LHA/1000

- 2004 IH 7400
- IH 275 HP / Allison MD3060
- 60 @ 3000 / DEUTZ 138 HP
- Mileage: 35,500

RECONDITIONED **\$185,000**



1997 VAC-CON V312THAE/1300

- Ford LNT8000 / 275HP / MD3060
- 50 @ 3000 Water Pump
- Mileage: 66,703 (kilometers)

RECONDITIONED **\$135,000**



2004 VAC-CON V390LHAD

- 2004 International 7400
- IH 275 HP / Allison MD3060
- 50 @ 3000 / DEUTZ 138 HP
- Mileage: 11,000

\$195,000



1998 VAC-CON VPD3612LHA

- 1999 IH 2554
- 275 HP / Allison MD3060
- 80 GPM @ 2000 PSI
- Mileage: 116,000

RECONDITIONED **\$130,000**



2000 VAC-CON V312LHA

- 2001 IH 2554
- IH 275 HP / Allison MD3060
- 50 @ 3000 / Cummins 110 HP
- Mileage: 122,800

RECONDITIONED **\$135,000**



2003 VAC-CON V311LHAD

- 2002 Sterling LT7501
- CAT 275 HP / Allison MD3060
- 60 @ 3000 / Cummins 130 HP
- Mileage: 69,700

RECONDITIONED **\$185,000**



2001 VAC-CON V312LHAD/1300

- 2001 Sterling LT9501
- CAT 380 HP / 10-Speed
- 50 @ 3000 / Cummins 110 HP
- Mileage: 73,000

RECONDITIONED **\$185,000**



1997 VAC-CON V316THA/1300

- 1996 FORD LTS9000
- 300 HP CAT / 10 SPEED
- 80 @ 2000 / John Deere 4045T
- Mileage: 78,500

RECONDITIONED **\$140,000**



www.vac-con.com



Ultimate Lease Hotline:
888-817.1757

969 Hall Park Drive • Green Cove Springs, FL 32043 U.S.A.
Tel: 904-284-4200 • Fax: 904-284-3305
www.vac-con.com • vns@vac-con.com

Safety First... We've got a handle on it!

Introducing Safety Bump™... The Solution to Transport Hose Problems



Safety Bumps™ replace traditional cam and groove caps and plugs, providing a comfortable handle for the driver's hand and a "bump" that extends beyond the hose fittings and ears, protecting them from damage. Safety Bumps, patent pending, are available in two, three and four inch, male and female models, in both hazardous and food grade configurations. Made from a glass-filled composite with antistatic additive or a food grade certified composite.



New Safety Lock™ eliminates spills due to cam lock ears opening up during deliveries. Safety Locks™, patent pending, replace unreliable Velcro straps and hard-to-operate locking cam lock ears with an easy-to-install and easy-to-remove, heavy duty 'clip' which clicks into place over the ears. **Save Your Drivers' Hands. Protect Your Fittings and Hose Trays. Safety Bumps™ now available in 2 inch.**



Safety Pumping Systems
(858) 530-8705
www.safetybumps.com
info@safetypump.com



Western Pacific Products, Inc.
"ANYTHING IN OR ON YOUR TANK"

Comforts of Home

Services, Inc.

LUXURY TRAILER SALES

- Lowest Interior Floor Height in the Industry
- ADA wheelchair accessible units.
- Unlimited Floor Plans from 8' to 53' Trailers
- Rigid Steel Shell Construction from top to bottom to resist rot and warping.
- Specializing in Customizing trailers to fit your needs.
- 24/7 Tech Support for the best customer service available.

- Free Nation Wide Lead Program for our customers.
- Easy Fold-Up Steps & Door Handles
- Large Capacity Waste Tanks
- High Privacy Partitions are Standard for Added Comfort
- Rigid Platform, our smallest wide body trailers start out with Dual 10" ASTM I-Beams.

Starting at \$13,400 with A/C, Heat, HD Steps and a Large 300 Gallon Waste Tank

See our website for more layouts and prices

8' starting at \$13,400
w/A/C & Heat - 300 gal waste

12' starting at \$21,300
w/A/C & Heat - 450 gal waste
includes Showers

20' starting at \$29,900
w/A/C & Heat - 600 gal waste

24' ADA starting at \$35,600
w/A/C & Heat - 750 gal waste

INFO@COHSI.COM • 877.382.2935 • WWW.COHSI.COM

TRUCK TOWN

2601 East Hwy. 80 • Abilene, Texas 79601

FULL SERVICE VACUUM SYSTEMS SUPPLIER

1-800-727-0350

GOOD ASSORTMENT OF CUSTOM SPEC TRUCKS FOR YOUR VACUUM UNIT NEEDS

LELY SEPTIC & OIL FIELD VACUUM TRUCKS
TROXELL TRAILERS

JEFF MULLICAN • HUBERT YOUNG • DENNIS ADAMS

Phone: 325-673-4642 • Fax: 325-673-4673
Web Site: www.truck-town.com • E-mail: truck@camalott.com



48 YEARS OF DEPENDABILITY

TUFF-JON

- One-Piece Construction
- Lightweight
- Rust-Free Hardware
- Wood and Poly Skids
- Large Variety of Colors



Tanks in 60, 105, 225, 300 and 440 Gallon Sizes



90 Gallon Free-Standing Sink



60 Gallon Rinse Tank

— OPTIONAL ACCESSORIES —



7-1/2 Gallon Handwasher



Tuff Jon with Lifting Bracket Assembly



Urinal



Paper Dispenser



Sky Heater



Exceptionally Strong Tank Design

The TSF Company Inc. | 2930 S St. Phillips Rd. | Evansville, IN 47712

Toll Free: **1-800-843-9286** | **812-985-2630** | Fax: **812-985-3671**

E-mail: tsftuffjon@sbcglobal.net | Web Site: www.tuff-jon.com



PORTABLE TOILETS | CHEMICAL TOILETS | HOLDING TANKS | HAND WASH UNITS



Super Products

Worldwide Vacuum Technology - Since 1972

Supersucker® with High-Dump Option

- › Rear Lift Height up to 60"
- › Unloads Efficiently
- › Heavy Duty
- › Low Maintenance
- › Easy to Operate



www.superproductscorp.com

800.837.9711

Custom Dewatering Solutions

COST-EFFECTIVE, TURNKEY SYSTEMS

Built to your specifications

Municipal • Industrial • Septage

Mobile Units • Skid Systems • Sales • Rentals

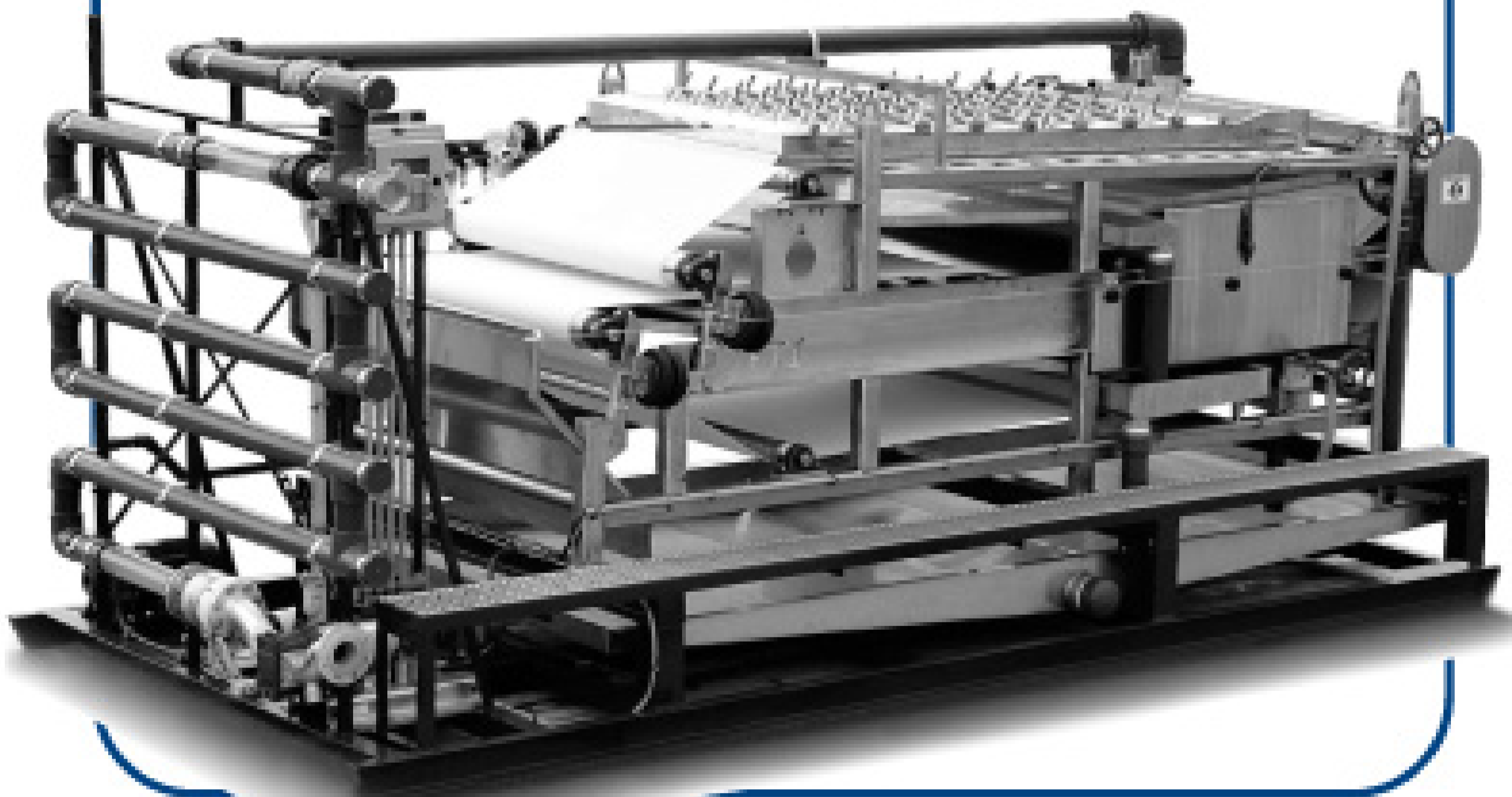

**FRONTIER
TECHNOLOGY,
INC.**

Call 269-673-9464

609 N. Eastern Ave. • Allegan, MI 49010
E-mail: frontiertech@frontierfilter.com
www.frontierfilter.com
Fax: 269-673-9629

NEED SOFTWARE?

THE **service** program

The Leading QuickBooks® add-on Software for today's Portable Sanitation Business.

- Interface with QuickBooks®-The Service Program generates your recurring route billing and seamlessly allows you to print the invoices in QuickBooks®.
- Easily Manage Routes
- Track Pick-Ups & Drop-Offs
- Palm and Windows PDA Handheld Support w/Remote Sync
- Works with Mapquest® and Mappoint®
- Track Inventory at Multiple Locations
- 30-Day Money Back Guarantee-Leasing Available
- Competitive Upgrades Available - Receive a Discount to Convert Off Your Existing System
- 30 Day No Risk FREE Trial with Weekly Training

866.480.1879

www.theserviceprogram.com



Toll-Free: 1-888-848-3727

LaVerne Charlet

email: lctanks@bellsouth.net / fax: 270-898-4055
175 Cascade Drive, Paducah, KY 42003

L.C. TANKS

4800 Gallon Septic Tank

824 C.F.M. Moro Storm
2007 Sterling 9500
58,000 G.V.W.
410/450 H.P. – 10 speed

\$132,800

Plus F.E.T.

Lease from **\$2,650** mo.



3800 Gallon (2) Compt Septic Tank

Masport HXL400 water cooled pump
Jetter system with reel
2008 International 4400
Auto transmission

\$116,247

Plus F.E.T.

Lease from **\$2,324** mo.



2008 Kenworth T300 - 22,000 GVW

Cummins diesel, Allison automatic, Hydraulic
brakes, AC, AM/FM, Turbo exhaust brake.

1700 Gallon POTEVAC 400 fresh / 1300 waste
Masport HXL 4, Burks wash down, Hot shift
PTO w/ remote. Unit hauler and tow package.

\$75,100 Monthly from **\$1030.**



3600 Gallon Masport HXL15, 360
CFM Pump, Tool Box

2008 Peterbilt 340

Cummins diesel,
10 Speed Transmission

\$106,170

Plus FET

Lease from **\$1,456** mo.



**Aluminum Slide-In Units.
NOW IN STOCK!**

300 Waste / 135 Fresh
Masport or Conde pump
Honda electric start
ShurFlo water pump

\$8,500

M.S.R.P.

Totally self contained!



A Buying Opportunity



Whether kicking truck tires or searching for new services to provide, liquid waste professionals show their purchasing power at the Pumper & Cleaner Expo

By Ed Wodalski and Jim Kneiszel

The latest in liquid waste technology was on display at the 28th Annual Pumper & Cleaner Environmental Expo International in Louisville, Ky., Feb. 28 to March 1.

The event, held at the Kentucky Exposition Center, attracted 11,415 attendees representing 4,688 companies and municipal agencies. A record 562 exhibitors displayed the best vacuum trucks in the world, advanced dewatering

technology to help the environment and every conceivable accessory a Pumper might need.

Here's a sampling of what attendees found on the show floor for the first time:

SEPTIC VAC TRUCK

Satellite Industries Inc. introduces a new septic truck with a 3,200-gallon **X-Ten Steel Septic Module**, built on a Kenworth T-300 chassis. The new truck features a front three-stage telescoping hoist and will hold 15 psi at the rear door. It also has a Masport HXL400V water-cooled pump and matching Masport components, stainless steel air piping, a Woods coupler, dual PTOs with variable speed control and 6-inch rear discharge. The 300-hp Cummins diesel engine is tied to an Allison 3000RDS automatic transmission. The interior includes many cab comfort features. **800/328-3332; www.satelliteindustries.com.**



NEW VACUUM PUMP

Moro USA Inc. introduces the **PM100 Turbo** 460-cfm pump with 4-inch inlet and outlet, Kevlar vanes, and a split oil reservoir that allowed designers to make the unit three inches shorter. The continuous duty pump is right angle drivable, producing 460 cfm at 22 inches of mercury. The high performance pump reduces recovery times and

was designed to accommodate new industries. It will be available this summer. **800/383-6304; www.morousaeast.com.**

TOWABLE TANK

The **Gooseneck Tank Trailer** from **B & W Mantrac Inc.** offers an economical way to add tank capacity whenever and wherever it's needed. The 1,500-gallon tank trailer with gooseneck hitch can be towed by a pickup truck and dropped as needed. The tank body acts as the frame, resulting in lighter weight. Movable axles are designed to transfer weight onto the tow vehicle, enabling the trailer to match the vehicle's load-carrying ability. Better traction and maneuverability also are achieved. A 2,500-gallon version will soon be available. **309/837-1989.**



FRONT END DEWATERING SYSTEM

The **IFRS 36 Separator** from **Accent Manufacturing Inc.**, Abbotsford, British Columbia, Canada, is designed to separate bulk

inorganic materials from septage and act as the front end of a waste dewatering system.

Septage is injected through an 8-inch line and is pushed through a set of flighting, leaving the solids to be discharged and the liquids to be conveyed for further processing via polymers or another technique. The separator was developed for sand-laden dairy manure and is now being used for septic and municipal waste dewatering. **877/855-4890; www.accentmanufacturing.com.**



RACE TEAM UNIT

Ameri-Can Engineering has added several upgrades to existing lines and has produced a specialty unit to be used by the Geico Racing Team. The **race unit** is fitted with a 20,000 kw generator to power the team's 11 trailers and showers in both men's and women's sides for convenience. All Ameri-Can trailers are outfitted with oak woodwork, skirting for a sleeker look, and upgraded electrical and lighting packages. Optional slide-out units have redesigned hydraulic systems. **574/892-5151; www.ameri-can.com.**



BIODIESEL FACTORY

Bio-Box from **Pacific Natural** provides the means to convert waste vegetable oil into biodiesel fuel. Available in standard cargo shipping containers, the processing system performs the conversion, while providing storage for methanol, waste vegetable oil and the refined biodiesel. The factory requires approximately 10,000 square feet of land to operate. **818/760-2823; www.stopxon.com.**



RUNNING WATER RESTROOM

Designed for construction jobsites and special events, **Sanitation Station** from **DropBox Inc.** offers running water



restrooms with full-height stalls and from one to three urinals and utility sinks. Made of a corrugated steel shell, the 20-foot unit includes

heating and air conditioning, heavy-duty rubberized floors and dual-locking access doors. A larger self-contained unit and auxiliary water and waste tanks are available. **888/388-7738; www.dropboxinc.com.**

STACKABLE SINK

The foldable, stackable **Handy Sink** from **Poly-Klyn** is designed for special events, campsites, emergency services, concerts, sporting events and wherever a portable wash station is needed. Made

of UV-protected polyethylene, the sinks feature eight taps with press-timing device, two water exits and wastepipe for hose. Measuring approximately 77 inches by 35

inches by 7 inches folded and 77 by 35 by 45 unfolded, the sinks take approximately 30 seconds to set up. An optional mirror kit with eight floating mirrors is available. **(00 34) 902-105-345; www.poly-klyn.com.**

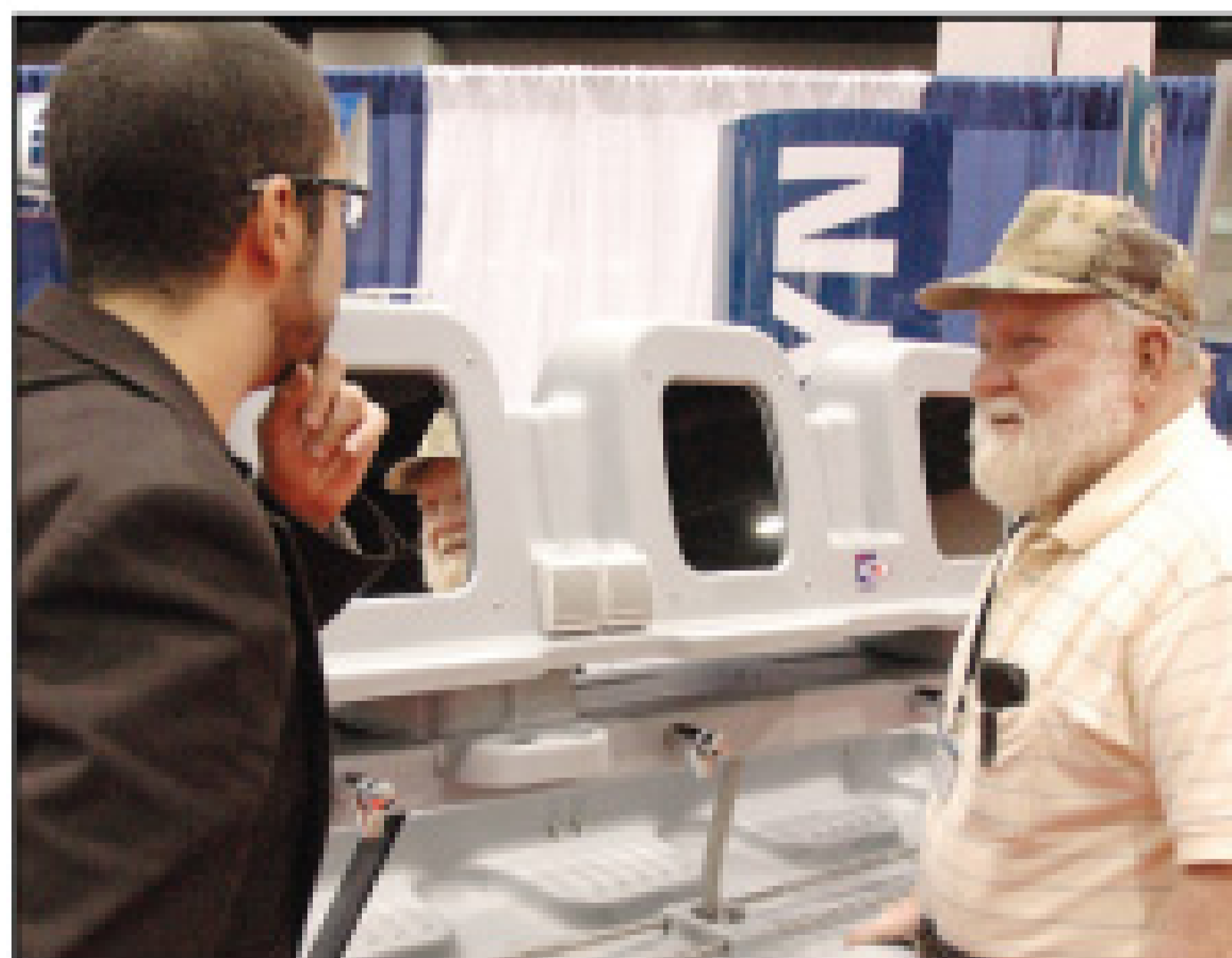

EFFICIENT BELT PRESS

The **Model 3DP belt filter press** from **BDP Industries** uses Independent Gravity Zone Technology to improve solids loading rate and cake solids. Separate gravity and pressure zones allow optimization of the porosity of the filter belt fabric and belt speed. Increased belt speed means a thinner cake is applied to the belt. Resistance to filtrate flow is reduced exponentially with reduction in cake thickness. **518/695-6851; www.bdpindustries.com.**



TWO ALARMS IN ONE

The **TS150 exterior dual alarm** from **Septronics Inc.** can be configured to monitor a filter and a pump, two basins, or a high-level and low-level alarm. The unit operates on 120V AC primary voltage with secondary battery backup (9V to 15V). It includes touch pad operation and automatic alarm reset. Red alarm LED, green power-on

LED, and yellow filter alarm LED are included. The alarm horn generates 83-85 db. **888/565-8908; www.septronicsinc.com.**

GRAFFITI REMOVER

Wipe Off graffiti remover from **Sunrise Environmental Scientific** is formulated to remove spray paint, crayon, ball-point pen, fingerprints, marker pen, pencil marks, tape residue, lipstick and more from Formica tops, washroom walls, concrete, brick, chrome and certain synthetics or plastics. It also can remove decals from vehicles and other metal surfaces. **800/648-1153; www.sunriseenv.com.**



TRIO OF EVENT RESTROOMS

Three new variations of the **Hampel 1.5 portable restroom** add a splash of color to satisfy discerning special event customers. The **Taj** is white with gray interior accents designed for wedding usage. The **Oro Rojo** is a gold and

red unit with color-coordinated interior colors. The **Grandeur** is produced in a classy two-tone gray color to provide a neutral backdrop for any event. The special units feature a StyleLight single station sink with towel holder and soap dispenser, an oversized mirror and a recirculating flush system. **800/549-1558; www.hampelcorp.com.**



SCENTED RESTROOM

The **Armal Scent Box** comes in five scents and colors, with the scent embedded into the plastic during the manufacturing process. Based on the new **Top Line** restroom, the units are Strawberry Field, Apple Blossom, Pinewood Trail, Rose Sensation and Vanilla Bean. The scent is designed to

last 3-5 years and can be recharged. Each Scent Box has its distinct color and a new embedded graphics product, called Mybox, allows restroom contractors to personalize units with their own logos or a variety of pre-designed graphics. The Top Line units have new beefier hinges, ergonomic door latch and other upgrades.

770/491-9458; www.armal.biz.

MOBILE VAC BOOM

Designed for hydro-excavating or vac-excavating, the **Mobile Vac Boom** flex-hose extension from **Ace Supply** attaches to a mini-excavator, excavator, skid-steer or backhoe, providing greater safety and more precise excavation.

814/899-3644; www.mobilevacboom.com.



COMPACT RESTROOM TRAILER

Black Tie Manufacturing has downsized its **Optimum Series** trailers. The smaller **8c** and **10c** models are unisex on both sides, run on basic 20-amp electrical service and can be appointed with a large array of options and features. The single-axle models can be pulled with a pickup truck or vacuum truck. The diminutive 8c weighs 4,000 pounds and has an overall length of 12 feet. **877/253-3533; www.blacktiemanufacturing.com.**



ALPHA MOBILE TRAILERS

The new **Century Series** and **Denali** restroom trailers manufactured for **Alpha Mobile Solutions** by Forest River were introduced in 2007, offering several configurations with a sanitary white interior featuring solid surface countertops, one-piece non-skid rubber flooring and china toilets for durability. The units have folding aluminum steps, crank-

down stabilizing jacks and several sizes to serve any special event customer.

877/789-1213; www.alphamobilesolutions.com.

DRAINFIELD REMEDIATOR

The **Aquaworx remediator** from **Infiltrator Systems Inc.** is designed to restore failing septic systems with minimal landscape disruption. Inserted into an existing septic tank, it reverses the drainfield clogging process. The unit includes a bacterial catalyst, a blend of aerobic bacteria that accelerate the consumption of clogging matter (biomat) in the drainfield.



The system includes an airlift column. Cusped plastic is wrapped around the bottom outside of the unit and placed within and above a bubble diffuser. The cusped plastic provides a substantial surface area for colonization of the introduced bacteria. The unit aerates and circulates effluent within the septic tank to generate an active bacteria culture, which creates an aerobic environment within the unit. These bacteria then enter the drainfield and consume

the clogging layer. **877/278-2979; www.infiltratorsystems.com.**

MINI DREDGE

The **Geoform International Inc. DINO Six** sediment removal system is a **mini dredge** designed to work with a dewatering bag

process from Industrial Fabrics in septage ponds, stormwater retention ponds and sludge lagoons. The hydraulic unit employs a 5-foot horizontal cutting head powered by a 60-hp Cummins diesel engine and a 6-inch discharge to send sediment to dewatering tubes or spoil piles. Working depth is 14 inches to 10 feet. The compact 3,000-pound unit can be used in small lagoons where other solutions aren't feasible. **913/782-1166.**



ALPINE RESTROOM

Five Peaks Technologies introduced the **Alpine**, a basic restroom with straight lines that contrasts with the angular look of the company's established Five Peaks Aspen and K2 models. The unit features a standard 60-gallon rotomolded drop tank and skid, an ergonomic grab handle, single integrated door return spring and single-wall construction with twin sheet construction in the door and jamb.

231/830-8099; www.fivepeaks.net.





AGITATOR SYSTEM

Gallup Agitator Systems Inc. showed its **Vac Truck Agitation System** installed in a Kenworth T-800 with a 3,500-gallon stainless steel waste tank. The agitator is designed to remove solid sediment from vacuum

trucks, trailers and tank bottoms. Now being marketed for use in sludge pits and other industrial pumping applications, the unit has been used in oil field and oil rig situations and to transfer heavy mud waste and industrial sediments. **403/793-4862; www.gallupagitator.com.**

INDUSTRIAL TRAILER

The new **Industrial Unit** from **Jag Mobile Solutions** is built to perform in the most adverse conditions, such as in fire response, oil field service, industrial and construction sites. The unit features floor and walls sprayed with heavy-duty truck bedliner protector, diamond-plate cover panels, brushed aluminum trim, one-piece floor, super heavy-duty hinges and stainless steel sinks. **800/815-2557; www.jagmobilesolutions.com.**



DUAL HEIGHT HAND SANITIZER

Filling a need for convenient hand sanitizers for children and the disabled, **PolyJohn Enterprises Corp.** introduces a dual-height **SaniStand**. The two-up, two-down system with offset foam sanitizer dispensers conveniently serves two adults and two children or disabled

individuals at once. The unit uses drop-in bags of non-alcohol hand sanitizer from PolyJohn's Rid-It line of products. **800/292-1305; www.polyjohn.com.**

ODOR NEUTRALIZER

Environmentally friendly, water-based **Odor-Solv** distributed by **Jack Doheny Supplies Inc.** is designed to kill mold and bacteria-causing odor, rather than masking the smell. The light-blue formula has virtually no odor of its own and can be diluted for use in restrooms, sinks, showers, and other sanitary applications. **248/349-5048; www.odorsolv.com.**



LANDSCAPE ROCKS

Artificial rocks and boulders from **Topp Industries Inc.** can be used to hide above-ground components of onsite treatment systems. The rocks are made of weather-resistant polyethylene resin that is fade-resistant and has a natural look and feel. **800/354-4534; www.toppindustries.com.**



FAMILY FRIENDLY RESTROOM

The **Family Room** enhanced access unit from **PolyPortables Inc.** features a wall-mounted, reinforced Koala baby changing station, extra hooks, trash can, a corner-mounted toilet with 40-gallon tank (60-gallon tank

optional), motion-activated lights (soon to be converted to LED technology), hand sanitizer and a recessed mirror. **800/241-7951; www.polyportables.com.**

MINI CONTAINER/RESTROOM COMBO

Restroom operators who want to test the waters with trash containers can start with the **RedBox+ Mini**, a 10-foot container manufactured by Wastequip that also hauls two portable restrooms. The unit is transported and placed with a hydraulic lift trailer controlled by a 9-hp Honda engine. The tandem axle trailer and combo unit can be pulled with a half-ton pickup truck and is designed for use at weddings, racetracks and small remodeling construction jobs. The units are made at 27 locations. **877/611-8069; www.redboxplus.com.**



WELLS CARGO PLATINUM

A contemporary European look is the hallmark of the new **Platinum Series Comfort Elite** restroom trailer from **Wells Cargo COG**. Standard features include Corian countertops, floating cabinets, vessel sinks, in-counter soap dispensers, backlit shatterproof mirrors, decorative lighting, china toilets, two 19-inch LCD televisions and CD/DVD player with AM/FM stereo. **888/574-4222; www.wellscargocog.com.**

EFFICIENT FILTER

BioDisc filters from **Geoflow Inc.** are placed between the effluent pump and the drip dispersal field to trap debris that could plug tubing and drip emitters. The units are designed for flows high in organics.

The disc filters are protected with molded-in Geoshield material to discourage biological growth on the element. Filters can be installed in a self-cleaning mode with a second filter and two solenoid valves, or they can be cleaned manually. The filter body and discs are molded from nylon resins. Filtration is 120 mesh/130 micron. The two-piece body is serviced by untwisting and includes an O-ring seal. **415/927-6000; www.geoflow.com.**



DUAL-PURPOSE TANK

The **MultiTank** from **Roth Global Plastics Inc.** can be used as a septic, holding or pump tank, rainwater tank, or potable water cistern. It has an inner layer of FDA-approved virgin HDPE, two inside layers of polyethylene for stability, and an outer layer of black UV-stabilized polyethylene. The tanks are manufactured with a computer-controlled blow molding process. **866/943-7256; www.roth-usa.com.** ■

The tanks are manufactured with a computer-controlled blow molding process. **866/943-7256; www.roth-usa.com.** ■

ALPHA Mobile Solutions



Manufactured by
Forest River



- Hot water heater
- A/C and heat strip
- 740 ga. waste tank
- 200 ga. fresh water tank



CALL FOR INFORMATION OR VISIT OUR WEBSITE

1-877-789-1213

www.alphamobilesolutions.com

OVERLAND TANKLINE



DOT 407/412 ACID TRAILERS



500 BBL PORTABLE FRAC TANK



STEEL TRANSPORT/KILL TRAILERS



TWIN DOT 407/412 ACID TANKS

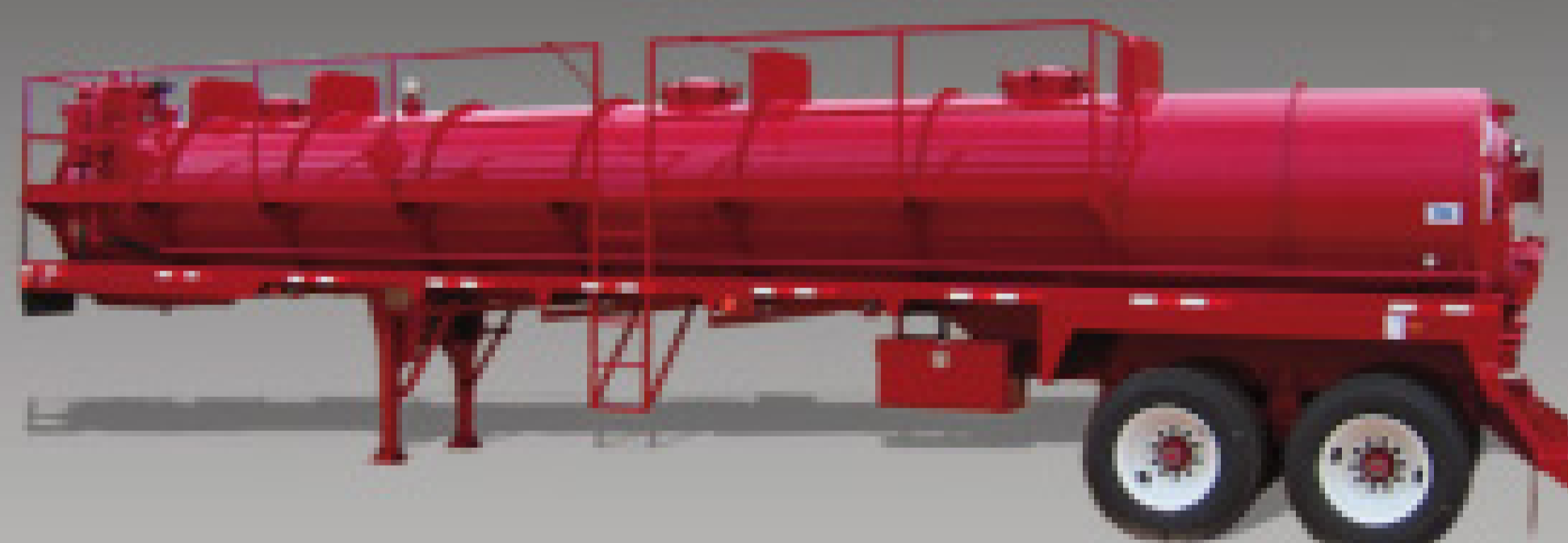

ASME CODE VACUUM TRAILERS

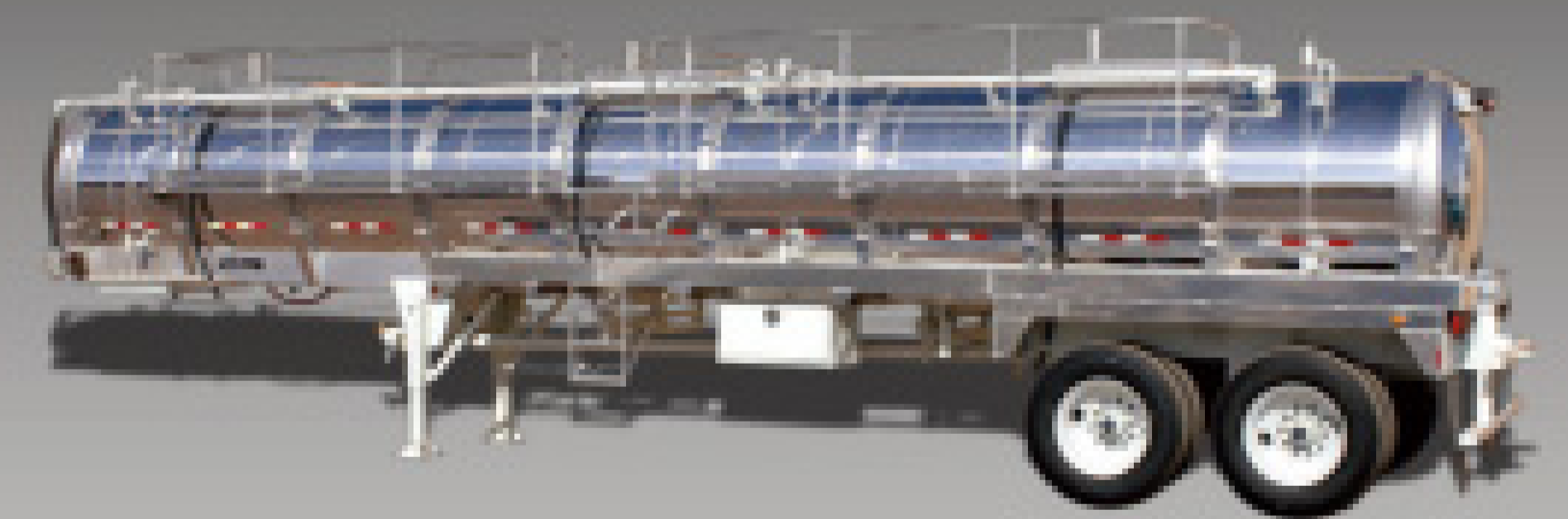

ALUMINUM VACUUM TRAILERS
ALUMINUM TRANSPORT TRAILERS



200BBL DOUBLE CONICAL CRUDE OIL TRAILERS



BOBTAIL VACUUM TRUCKS

IN STOCK

4725 FM 18 ABILENE, TEXAS 79602 WWW.OVERLANDTANK.COM TOLL FREE: 866.635.7132

Big Air. Deep Vacuum.

High vacuum blower packages designed for truck-mounted liquid waste handling systems. Industry leading design, engineering and fabrication by the pump package pioneers. Rugged construction and a wide selection of setups that are easy to install. Available in 600, 1000 and 1500 CFM. Call today for pricing: 800-253-5500.



1457 High Vacuum Blower • 1530 CFM • Made in the USA

www.nvepump.com

National Vacuum Equipment - Traverse City, Michigan

NVE
Powerful. Performance.



CAPITAL RUBBER CORP

Get Connected.

YOUR SOURCE FOR ASSEMBLIES AND MORE!



POWER BOOSTER

**PATENTED TECHNOLOGY
PROVEN TO:**

- INCREASE VERTICAL LIFT
 - REDUCE OPERATOR FATIGUE
 - REDUCE VACUUM PUMP WEAR
 - SAVE TIME ON DIFFICULT JOBS
- CALL FOR MORE INFORMATION -



**EPDM
WEATHERFLEX
SUCTION HOSE SPECIAL!**

3" X 25 FT \$99

3" X 33 FT \$125

COUPLINGS INCLUDED!

- SHIPPING ADDITIONAL -

INFO@CAPITALRUBBERCORP.COM

(800) 258-3000

WWW.CAPITALRUBBERCORP.COM

ARMSTRONG EQUIPMENT INC.

MODEL 806B *SEELEVEL* ANNIHILATOR™

MODEL 806B *SEELEVEL* ANNIHILATOR™

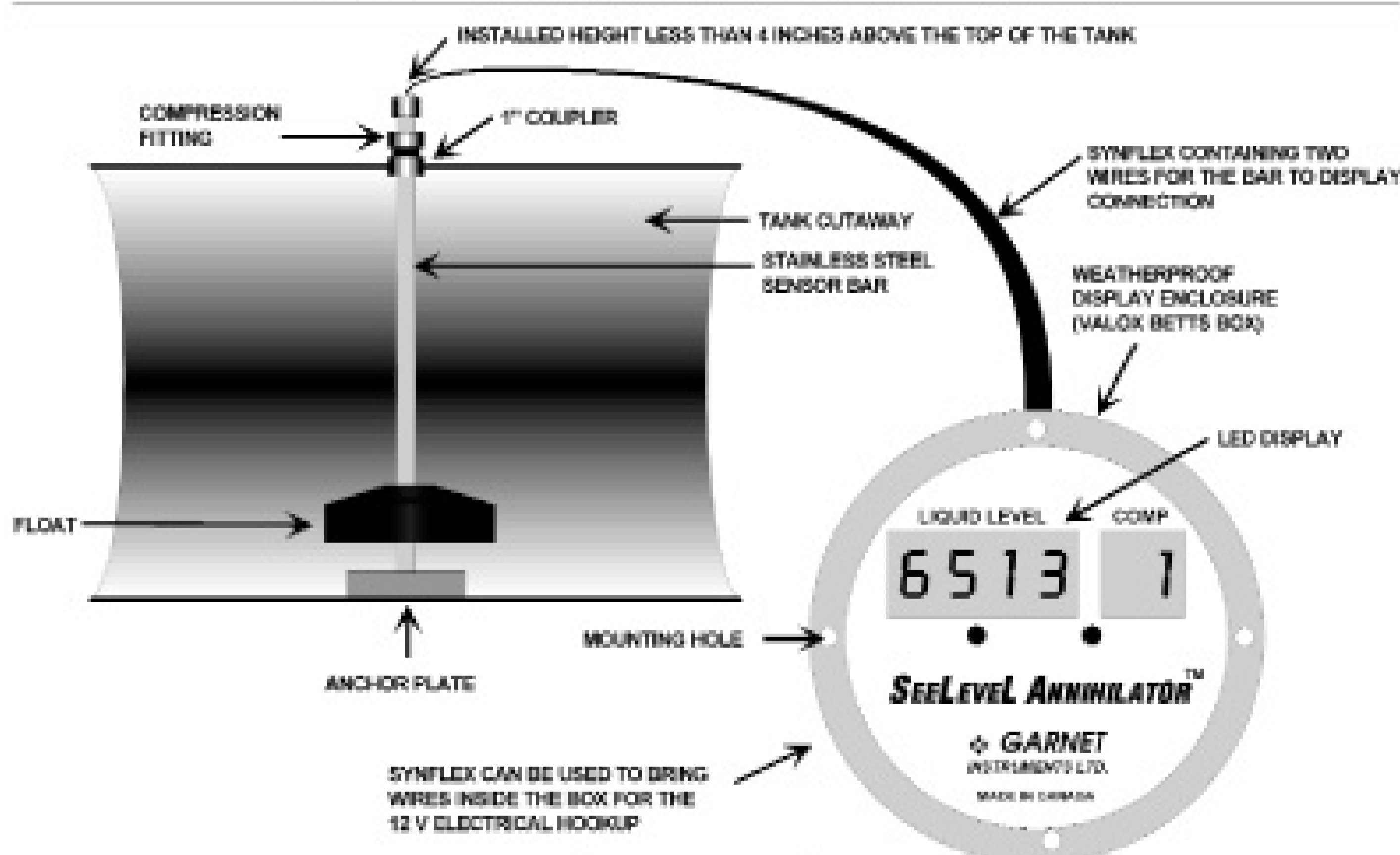

• **Accurate Readings to 1/4"**
Even with vacuum or pressure on the tank. No need to shut down pumping to check tank level.

• **Work Safely**
Can be programmed to control warning devices.

• **Plan Your Route**
Tracking customers tank size allows for improved route planning.

• **Protect Your Pump, Avoid Spills**
See the level of your tank throughout the pumping process.

• **Maximize Efficiency**
Avoid unnecessary trips. Can I get one more load, or should I head for the dump? The guessing game is over.

• **Communicate With Your Customers**
Pumping 1500 gallons from a 1000 gallon tank indicates problems

These are all good reasons to equip your next truck with a SeeLevel model 806B liquid level gauge system. The 806B can be programmed to read liquid levels in up to three compartments with only one display. It can also accept up to three alarm settings for triggering a warning light, sounding an audible alarm, or closing a loading valve; all while the tank is loading.



11200 Greenstone Ave. | Santa Fe Springs, CA 90670
800.699.7557 or 562.944.0404 | fax: 562.944.3636
e-mail: sales@vacump.com | web: www.vacump.com

To find out if the 806B can benefit your business, contact your tank manufacturer or call us
Toll Free at 1-800-699-7557

GET SHOWERED WITH SAVINGS AT LELY!



THANK YOU JG MANUFACTURING



THANK YOU READILITE & BARRICADE, INC.

Financing Available



THE ORIGINAL GEM JET IS STILL THE BEST. 2000 PSI @ 15 GMP



MOST EFFICIENT SEPARATOR ON THE MARKET



300 + 100 GALLON READY TO GO UNIT THAT WILL FIT IN THE BACK OF YOUR PICK-UP



THANK YOU MANCHESTER SEPTIC & ROOTER



THANK YOU JIM WHEELER

WE HAVE STEEL TANKS IN STOCK READY TO BE MOUNTED ON YOUR TRUCK



SERVING THE LIQUID WASTE INDUSTRY FOR OVER 50 YEARS

LELY MANUFACTURING

P.O. Box 789 • Wilson, NC 27893
252-291-7050 • FAX: 252-237-7726
E-mail: sales@lelyus.com

800-334-2763

John Minnis, Sales Representative •
540-547-2463

Charlie Gilantzis, Sales Representative •
252-360-6331

Roy Coffey, Sales Representative •
828-312-9545

www.lelyus.com

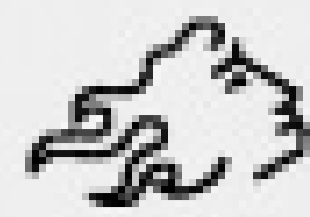

Placing a value on what you've built.

A knowledgeable buyer can make all the difference.

We own a portable restroom business in Southern California and are actively looking for potential acquisitions across the U.S. So if you have built a quality business in the portable sanitation industry, we would like to meet with you.

At Prometheus, we specialize in acquiring profitable, middle market companies in route businesses.



And we are especially focused on the portable sanitation industry. Here's why you should contact us:

CAPITAL

Whether you are looking to sell your business or are looking to grow, you need capital. We are a cash buyer and can complete a transaction quickly.



Also, our relationships within the financial community provide access to additional sources of capital necessary to grow

your business. If you are interested in selling a portion or all of your business or if you believe a committed equity partner can help you achieve the vision you have for your business, we would look forward to meeting with you.

Nicholas Peters
President and CEO

Chris Suh
Director

Chris Russell
Principal



PROMETHEUS

Advance

PUMP & EQUIPMENT INC



**Custom
Pump Trucks
Built to
Your Specs**



Thanks Nathan

Roto-Rooter of Cedar Rapids
500 Gallon Steel Hoist/Rear Door w/ 957 NVE Blower System

**Call Today
For
Professional
Blower
Installation**



NVE
DISTRIBUTOR

**6000 Gallon
Short Tanker Trailer**

- Excellent for Septic & Grease Trap Service.
- Call for more Information

**Less Trips =
Less Fuel**

**Introducing the JT1030
\$5,995.00**

**Introducing the JT530
\$4,250.00**



Toolbox Jetter JT1030

- Polished Aluminum Toolbox (28 x 28 x 48)
- 10 GPM @ 3000 PSI Water Pump w/Pulsator
- Gearbox Drive - Standard or optional Hydraulic Drive
- Bucket Fill/Drain
- Air Rewind Reel w/200' of 1/2" Hose
- Chrome Guide Rollers on Reel
- Wash Down Gun w/ (4) Quick Connect Tips
- Jet Nozzle - Flushing
- Includes Mounting Brackets

**Add Jetting
To Your
Pump Truck**



Toolbox Jetter JT530

- Polished Aluminum Toolbox
- 5 GPM @ 3000 PSI Water Pump With Pulsator
- Electric Start Engine
- Remote Fuel Tank
- Electric Rewind Reel With 200' of 3/8" Hose
- Chrome Guide Rollers On Reel
- Washdown Gun With Quick Connect Tips
- (1) Jet Nozzle
- Stainless Tool Rack

Toll-Free 1.877.557.PUMP (7867)
"Partners in Performance"

Call For A Quote Today!

www.AdvancePump.com

15418 Old Highway Road • Peosta, Iowa 52068
877.557.PUMP (7867) • Fax: 563.557.0961

Pumping in PARADISE

Longtime Hawaiian portable sanitation provider overcomes logistical issues to thrive in tropical island territory

By Sharon Verbeten



A row of trailer-mounted NuConcepts restrooms (above) helps Paradise Lua provide high-class special event service. At left, George III and Jeanette Grace, the owners. (Photos by Anthony Consillio and courtesy of Paradise Lua)

George Grace III has been a powerhouse concern in the state for more than 40 years. Today the business serves three of the state's larger islands with an inventory of 2,500 restrooms.

PLYWOOD UNITS

Jeanette Grace calls the company's founder — her late father-in-law, George Grace Jr. — a “pioneer” in the state's portable sanitation industry, getting it up and running at a time when others weren't as forward-thinking. He initiated his concept on the island not long after Hawaii gained statehood in 1959.

“He was a construction worker himself,” Grace says, “so experiencing no restrooms on a job-site made him think.” He built a restroom out of plywood and fiberglass and toted the unit to a bank, looking for financ-

ing. “They thought he was crazy,” she says. “They couldn't grasp the concept.” But he succeeded in convincing the bankers; then it was up to the public to embrace this newfangled idea.

“It was kind of slow going in the beginning until people started seeing it, using it,” she says. Paradise Lua mainly serviced the construction industry, but soon branched out into special events and military contracts.

Grace, who began working for the company in the 1980s, recalls the “interesting” atmosphere at Schofield Barracks, a U.S. Army training base on Oahu, which rented her company's units. “I remember units on the training site getting run over by Army tanks. Sometimes



Technician Jeff Smith prepares to service restrooms at Ko'olina resorts.

Even when you live in paradise, running a portable sanitation business is not without its challenges. And Paradise Lua, a firm serving the Hawaiian Islands, is no stranger to the ups and downs of the industry. They just happen to face issues those on the mainland may never encounter.

Despite the challenges of serving multiple locations — separated by vast expanses of ocean — the firm owned by Jeanette and

Profile

Paradise Lua Kapolei, Oahu

Owners: Jeanette and George Grace III
 Founded: Early 1960s by George Grace Jr.
 Employees: 28
 Services: Portable sanitation
 Service area: Oahu, Kauai and Hawaii; plans to expand to Maui in 2009
 Web site: www.paradiselua.com

HAWAIIAN ISLANDS

"I NEVER DREAMED I'D BE IN THE SANITATION BUSINESS, BUT I CAN'T IMAGINE MY LIFE NOT IN IT."

Jeanette Grace

they got mistaken for targets ... and were blown up; it was interesting," she says.

Based on Oahu, Paradise Lua continues to serve the military's needs through contracts that they bid on. "What we cater to are the different branches of the military that come down for special training," Grace says. "A lot of them are in remote areas where you need four-wheel drives to get to." She estimates about 20 percent of the company's business is on military sites.

When Grace's father-in-law was ready to retire in the 1990s, Grace and her husband took over the business and continued to expand its market share and client base. She estimates about 60 percent of the business caters to construction, with the remainder made up of special events, the military and private individuals. The special events, Grace says, are similar to those businesses serve on the mainland, with the possible exception of luaus.

This is Paradise Lua's second year servicing the Great Aloha Run, held on Presidents' Day. They provide more than 200 units to the busy event, held in downtown Honolulu. Another high-profile special event they serviced was the National Football League's Pro Bowl at

Aloha Stadium in Honolulu.

"We are a supporter of the University of Hawaii Warriors, so we donated units to Aloha Stadium," Grace says. "There were 44 units on the inside of the stadium for the Pro Bowl. We also had one of the restroom trailers out on the Wednesday before the game for the Paradise Cove Pro Bowl Luau (an event for Pro Bowl players and their families). We have been doing this event for years and enjoy it every time."

In addition, Paradise Lua also serves private parties, concerts and golf tournaments. "Our rentals for special events range from portable units to restroom trailers, depending on the number of attendees and time frames."

GROWING PAINS

With growth comes expansion, naturally.



Setup and maintenance are being done onsite to ready a Paradise Lua restroom trailer for a special event.



A typical event setup for Paradise Lua features central shared hand-wash stations and appropriate screening in front of a urinal unit, shown at the right.

But how do you expand across an ocean? That was the logistical challenge Paradise Lua faced when it decided to extend its reach beyond Oahu. That base camp is where the company stores the majority of its units, mostly from PolyJohn Enterprises Corp., and some from PolyPortables Inc. and NuConcepts, restroom trailers from Ameri-Can Engineering, and transport trailers from Explorer and Wells Cargo.

Grace says they keep 80 to 100 units onsite to fill short-term rentals, but most of the company's 2,500 units are in the field — on one



This Isuzu vacuum truck is easy to see in a crowd and is highly maneuverable when servicing a well-attended event on the islands.



Paradise Lua has long served the National Football League Pro Bowl festivities in February, which includes this trailer set up for players and guests.

“OUR BIGGEST HEADACHE IS (INTER ISLAND) SHIPPING BECAUSE ONLY ONE COMPANY DOES IT. THAT CREATES A BIG CHALLENGE. YOU DON’T WANT TO RUN INTO AN ISSUE WHERE A BARGE GOT OVERBOOKED AND THEY’RE UNABLE TO TAKE OUR STUFF.”

Jeanette Grace

island or another. That goes for their fleet as well. Trucks — primarily Ford F-350s and Ford F-450s with a combination of Masport and Conde pumps — are delegated to each island, where they stay.

On the big island of Hawaii, Paradise Lua has three vacuum trucks — among them, a 1997 Ford F-350 4x4 that utilizes a Best Enterprises Inc. 300-gallon waste/110-gallon freshwater stainless steel tank. Three of its tank trucks on the other islands have the same capacity. Two service trucks on Oahu feature Keith Huber tanks, outfitted with Masport pumps.

Maintaining inventory on each island (Oahu, Kauai and Hawaii) has proven to be a time-saving and economical measure — ensuring that units are readily available on each respective island. “Now we really don’t have to take from the Oahu inventory,” Grace says, adding that each island’s base camp is kept fairly well stocked.

When the company purchases new units, for example, they have the manufacturer ship directly to the island where the units are needed because the cost of shipping is so high. “It’s cheaper for us to purchase unassembled units,” she adds. “We can fit 88 unassembled portable toilets into a container rather than 20 assembled units. We’ll fly people up there to assemble the units,” she says.

Likewise, Paradise Lua must pay a hefty shipping fee to get its trucks shipped from the mainland. Depending on the vehicle’s dimensions, shipping costs range from \$1,600 to \$5,000 per truck.

Occasionally, increased demand requires Paradise Lua to ship units or trailers between islands. And while that can get expensive,

At right, the climate is so good that unassembled components for PolyJohn PJ3 units are stored outside at the company yard. Below, workers have an assembly line of PJ3 restrooms going. Paradise Lua buys all units unassembled to save shipping costs. Below right, Geoffery Grace and Nahe Medeiros assemble units under supervision.



Grace says the company rarely passes the shipping costs on to the customer.

“Our biggest headache is shipping,” Grace says, “because only one company does it. That creates a challenge. You don’t want to run into an issue where a barge got overbooked and they’re unable to take our stuff.”

“Everything is shipped by barge to the other islands,” she says, adding that the distance between the islands can range from 100 miles to several hundred miles. They can ship about 20 units in a 40-foot container load. It costs \$605 to ship single units in a 20-foot container, \$1,000 for a 40-foot container.

In its inventory, Paradise Lua has 10 restroom trailers, located on both Oahu and Hawaii. “If we have a special event that requires a restroom trailer, we do ship those from island to island,” Grace says. Roundtrip cost is about \$1,300.

The price of doing business across an ocean is part and parcel of owning a business in Hawaii. But fortunately, “We’re at the stage right now where the units on each island are enough to service (that island); we haven’t had an instance lately where we’ve



had to take from one island to another,” Grace says, adding that the company usually ships on a quarterly basis.

And to keep costs down, maintaining units in good working order is a priority, especially in a hot, humid climate, which puts added demands on deodorant products. “It basically means we have to purchase chemicals that are stronger than the others,” Grace says.

BRANCHING OUT

Paradise Lua employs 28 full-time staff, moving them around as needed. The company transferred two Oahu drivers to Kauai, for example. And Grace also sent her niece and nephew to run that office. “I would say maybe 80 percent of our employees are family members,” she says. “I think it works out quite well. They are the future of Paradise Lua.”

As staff move to accommodate the growing business, Paradise Lua is focusing on even



Koa Grace (left) and Keoki Medeiros (right) load a restroom on a truck carrier for return to the yard.

Stepping in when competitors fail

Hawaii has a population of about 1.3 million, spread out among eight main islands. So there would appear to be ample opportunity for those wanting to enter the portable sanitation market there.

But Jeanette Grace, co-owner of Paradise Lua, says that appearance has caused some potential competitors to fail. In turn, however, Paradise Lua has been able to expand its business through acquisition of some of those corporate failures.

"There's quite a bit of competition (on the islands)," Grace says. "Some companies have been around for 20 years, and a lot of new companies want to try it."

Several entrepreneurs have gotten into the business hastily and realized "the turnaround income is not what they expected," Grace says. They then come to Paradise Lua, asking if the company would be interested in purchasing them.

"We've bought out several smaller companies," Grace adds. That has helped increase both Paradise Lua's fleet and market share.

In one case, it also got them more fully entrenched in another venue. "On the Big Island, there was a company that closed down and had inventory he wanted to sell, so we purchased the inventory. That kind of helped us expand on the Big Island."

Technician Jeff Smith gives a regular cleaning to an Isuzu service truck.



Below, the Paradise Lua crew includes (back row, from left) Theo O'Neal, Keoki Medeiros, Jeanette Grace, Liona Spencer, Ronell Grace and Joe Mangca. Front row, from left, Lani Medeiros, Geoffrey Grace, Nahe Medeiros and Polly Grace.



greater expansion in 2008. "We're looking to branch out on Maui," Grace says, hoping to add the state's second-largest island to its chain by 2009. "We've had a lot of inquiries about our services."

Grace admits it can be costly to take that leap, so Paradise Lua has been researching the market and scoping out sites for a base camp.

"Once we plant ourselves and the roots start taking place, we don't want to worry about moving around," she says. "We want to do a bit more research (on Maui) to make sure there is a bit more work. We'd need to make sure there's enough business to pay for itself," she says. "We'd need to get a base yard and decide if we're going to relocate drivers from Oahu to Maui or hire from that island."

Grace adds that there is a lot of construction taking place on Maui, but the company remains firmly rooted at its home base as well.

adds.

While it may seem hard to believe that a water-locked island could provide ongoing construction projects to service, Grace says that hasn't been a concern. "Construction is an ongoing thing ... with people moving to Hawaii," she says. Hotels, shopping centers, new homes and road-widening projects provide plenty of work.

Paradise Lua has followed the state through decades of change and growth, and it likewise has done the same. Grace credits their company's longevity to its passion for customer service. "For me, the most rewarding thing is to hear people actually compliment my business. Customer service is a priority," she says.

And that's become especially important to Grace, who simply married into the portable restroom business, but has never looked back. "I never dreamed I'd be in the sanitation business, but I can't imagine my life not in it."



Accounting staff Tanya Mason (standing) and Ronell Grace are shown in the office.



Technician Angel Rodrigues pulls returning units from a flatbed trailer. The units will be cleaned and returned to service.

MORE INFO:

Ameri-Can Engineering
574/892-5151
www.ameri-can.com

Best Enterprises
800/288-2378
www.bestenterprises.net

Keith Huber
800/334-8237
www.keithhuber.com

Masport Inc.
800/228-4510
www.masportpump.com

McKee Technologies Inc.
866/457-5425

NuConcepts
909/930-6244
www.nuconcepts.com

PolyJohn Enterprises
800/292-1305
www.polyjohn.com

PolyPortables Inc.
800/241-7951
www.polyportables.com

Wells Cargo COG
888/574-4222
www.wellscargocog.com



EXPLORER

SANITATION & RECYCLING

The Standard In Portable Toilet Transportation!

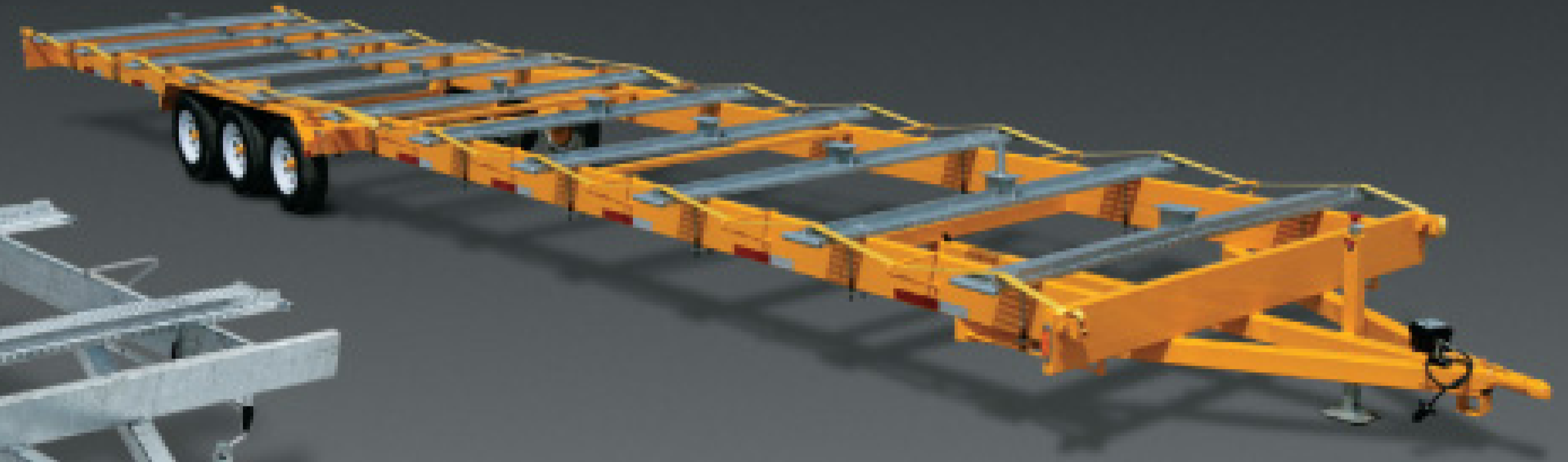
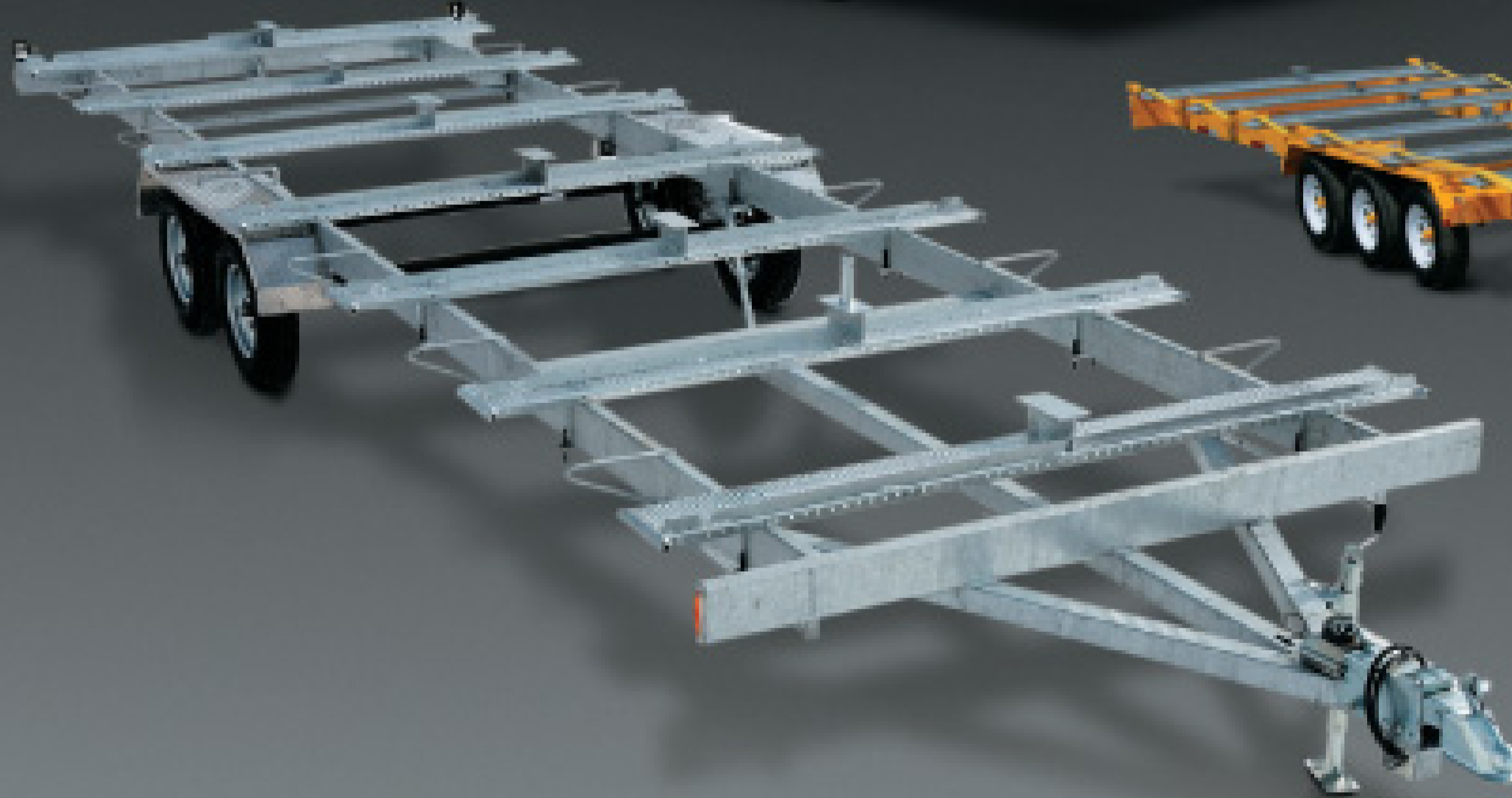

California

PLUMAS SANITATION
Tel: (530) 832-0370
Fax: (530) 832-0373
Pertola CA

Colorado

Columbia Sanitary
Tel: (303) 526-5370
Fax: (303) 526-9686
Golden CO

Texas

WOYT ENTERPRISES
Tel: (903) 586-6493
Fax: (903) 541-0874
Jacksonville TX

Florida

STEVE BAIE ENTERPRISES
Tel: (407) 709-8175
Fax: (407) 822-3998
Apopka FL

CALL FOR PRODUCT LITERATURE

Toll Free 1-866-457-5425 fax 519-669-8331
email: info@mckeetechnologies.com

Manufactured by: MCKEE TECHNOLOGIES INC. ELMIRA, ONTARIO, CANADA N3B 2Z7



Amthor Matador

We're proud to be an official distributor of



aluminum, steel and stainless steel vacuum tanks.



Call TODAY for immediate delivery.

(888) 204-7872

www.stuarttank.com

940 East Geneva Street PO Box 558
Elkhorn, WI 53121

Terms – No Problem

*We finance all types of equipment.
We offer a variety of terms, all designed
to meet your cash flow and/or tax needs.*

Community Leasing Associates, LLC

1-877-459-5770

www.clalease.com



Good People - Great Rates



THE BEST!

Art Blaster

Biodegradable Graffiti Remover

ART BLASTER ---

Takes off paint, pen, crayon, tar, soap scum, grease, calcium buildup and many more substances from Portable Toilets.

ART BLASTER ---

Leaves behind a *protective sheen* that prevents new offensive graffiti—even pencil wipes off!

ART BLASTER ---

Environmentally and user friendly. Created to work hard so you don't have to.



Call our customer service team for more details.

1-800-345-3303
www.jjchem.com



Juggler™

The **ONLY** **NSF** **CERTIFIED,**

solid-liquid separator
for grease traps and
septic tanks that's
SMARTER and
GREENER than
a standard
Pumper truck!



labrie
environmental group

ISO
9001
2000

1 800 463-6638 | www.labriegrup.com

Contact Robert Lamarche at 1 514 919-0347
New video at www.labriegrup.com

LIBERTY PUMPS



Omnivore LSG 200
Residential Grinder

We Carry a
Full Line of
**LIBERTY
PUMPS**
which come
with a
**2-year
warranty**



280-Series Mid-Range
Effluent Pump

Regenair®
R3105-12
Blower
\$410



**Hydromatic,
Zoeller, ABS,
Liberty &
Myers
Pumps**



**Sutorbilt & Roots
Blowers**



SDS
From 70-180 cfm



**DC-STAINLESS
Washdown Pump**



**Moro PM80
Turbo 350 cfm**



**Moro
M3
176 cfm**



**Moro
M-10
230 cfm**



Moro Pumps: from 176 to 1642 cfm

Flagg-Air Model 340

\$325

- 3450 rpm
- 1/4 hp, 115V
- Enclosed motor
- Stainless steel shaft
- High impact plastic parts
- Operates quietly
- 2-yr. warranty
- Fits in place of most original manufacturers' units
- Replacement parts available



The Flagg-Air 340 does not carry the NSF seal. Check local and state regulations for approval in your area.

**MEDO
Piston**
LA-60B \$275
LA-80B \$300
LA-100B \$445



SECOH Diaphragm
EL 60 \$255
EL 80 \$300



0523
Rotary Vane
Compressor
\$310



Septic Services, Inc. toll free 1.800.536.5564 • 636.583.5564 • fax 636.583.6432
e-mail septic@fidnet.com • web www.septicserv.com

Refuse Systems



Your truck specialists in the solid and liquid waste industries.

If you are in the market for a refuse vehicle, make Rush Refuse Systems your resource. We have one of the largest inventories of work ready trucks in the country, representing the industry's leading brands. Whether you need to buy, rent or lease, we have a full spectrum of financial resources available. And, we support you through our Rush Truck Centers network of over 50 locations — with an extensive parts and accessories inventory, highly skilled ASE-certified service professionals and exceptional body shop capabilities.



Peterbilt 340 Industrial Vacuum Trucks

Automatics and Standards in stock ready for delivery. DOT 407/412 3150 Gallon Cusco units. Moro PM100 Pump, Hydraulic full opening rear, Vibrator Box, Air actuated valves, Full Walkway with handrail, 20 Ton Dump Capacity Cylinder.



Peterbilt 340 Standard Vacuum Trucks

Automatics and Standards in Stock ready to go to work. Non Code 3600 Gallon Pik-Rite Tank. Masport HXL400WV Liquid Cooled Pump, Aluminum Hose Trays, Internal Primary to secondary Piping for clean mount. 10 yr Tank Warranty Standard. Options can be added before delivery. Compare our standard Specs to anybody!



2007 Peterbilt Model 357 Roll Off

Pre 07 Emission, Cat or Cummins, 8LL Transmission, 20 Fr/ 44-46 Rears, Air Trac or Hendrickson Suspension, 60K or 75K Hoists, Pioneer and O'Brian Tarpers, Mounted or Cab and Chassis Still Available!



2007 and 2008 Peterbilt Cab and Chassis

Whether you're putting an old tank on a new truck, or custom building a truck the way you've always wanted, call us and choose from a wide variety of models and specs on the ground. Fast shipping available to your destination. Tank dealers and manufacturers welcome.



www.rushrefusesystems.com



877-661-4511

Refuse Sales Team: Gregg Wilkinson | Jason Guzauskas | Jesse Fullilove | Hal Holloway
refusesales@rush-enterprises.com

8810 IH-10 East | San Antonio, TX 78219



TIGERFLEX™

Tiger™ Green/Tiger™ Yellow/Tiger™ - SD

- Superior EPDM compounds - longer life; more durable; superior chemical resistance.
- Superior Flexibility - 22% more flexible! Easier to handle off trucks, especially in cold weather!
- UV and weather resistant exterior.
- Specially designed abrasion-resistant helix - slides over and around objects; easier to handle and work with.
- Tiger™-SD - reinforced for both suction & pressure discharge applications.

Applications:

- Septic handling
- Liquid and dry chemical & fertilizers
- Sewer cleaning water jetting leader hose
- Construction



Kuriyama of America, Inc. 360 E State Parkway | Schaumburg, IL 60173
847.755.0360 | fax: 847.885.0996 | email: sales@kuriyama.com | www.kuriyama.com



Toll Free 888-207-2074 Fax (479) 770-6089

WILCOX TRUCK SALES, INC.

Lowell, Arkansas ... ESTABLISHED 1978

I-540 Exit #78 & Hwy 71B

2 hours East of Tulsa or 1.5 hours South of Joplin

www.wilcoxtrucksales.com

1999 Mack CH613

E7 Mack, 380 HP, 9 Speed, New 3360 Gallon Vacuum Tank, New Jurop R260 Pump, Custom Paint, 205' WB, One Owner, Fleet Maintained, AC, PS, Cruise, Ready to Make You Money



1994 Freightliner FLD120

3406E Caterpillar, 355 HP, 9 Speed, 4 Bag Air Ride Suspension, 3.91 Ratio, 219' WB, 3000 Gallon Vacuum Tank, 8) Matched Virgin Drivers.



RouteOptix Inc.

Customer Service
Optimized Routing
Visual Dispatch
Asset Management
Disposal Tracking
Customer Billing

A Complete Software Solution

(866) 926-7849

www.routeoptix.com info@routeoptix.com



WE DELIVER MORE THAN JUST A SHINY NEW TRUCK...

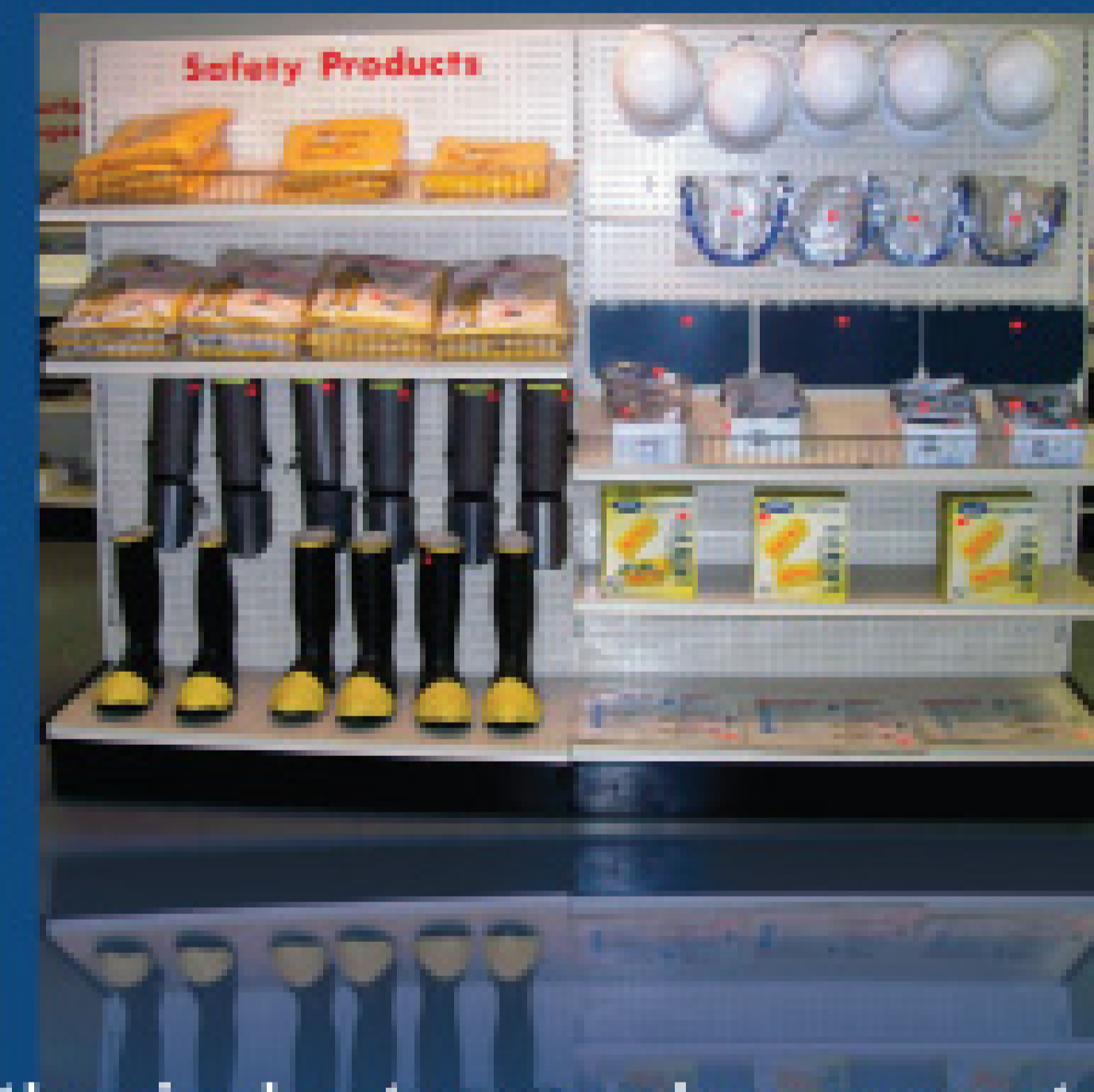
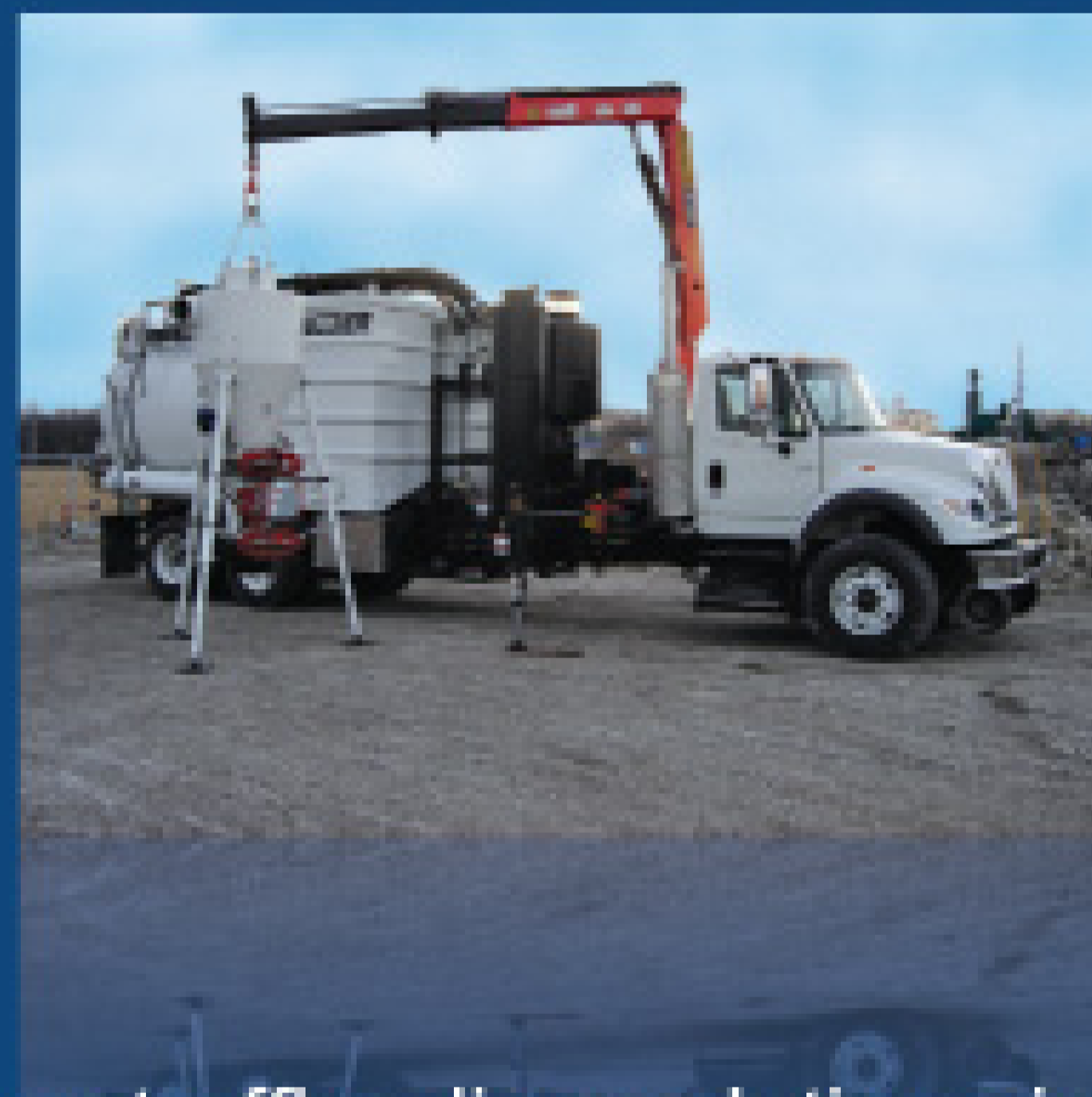
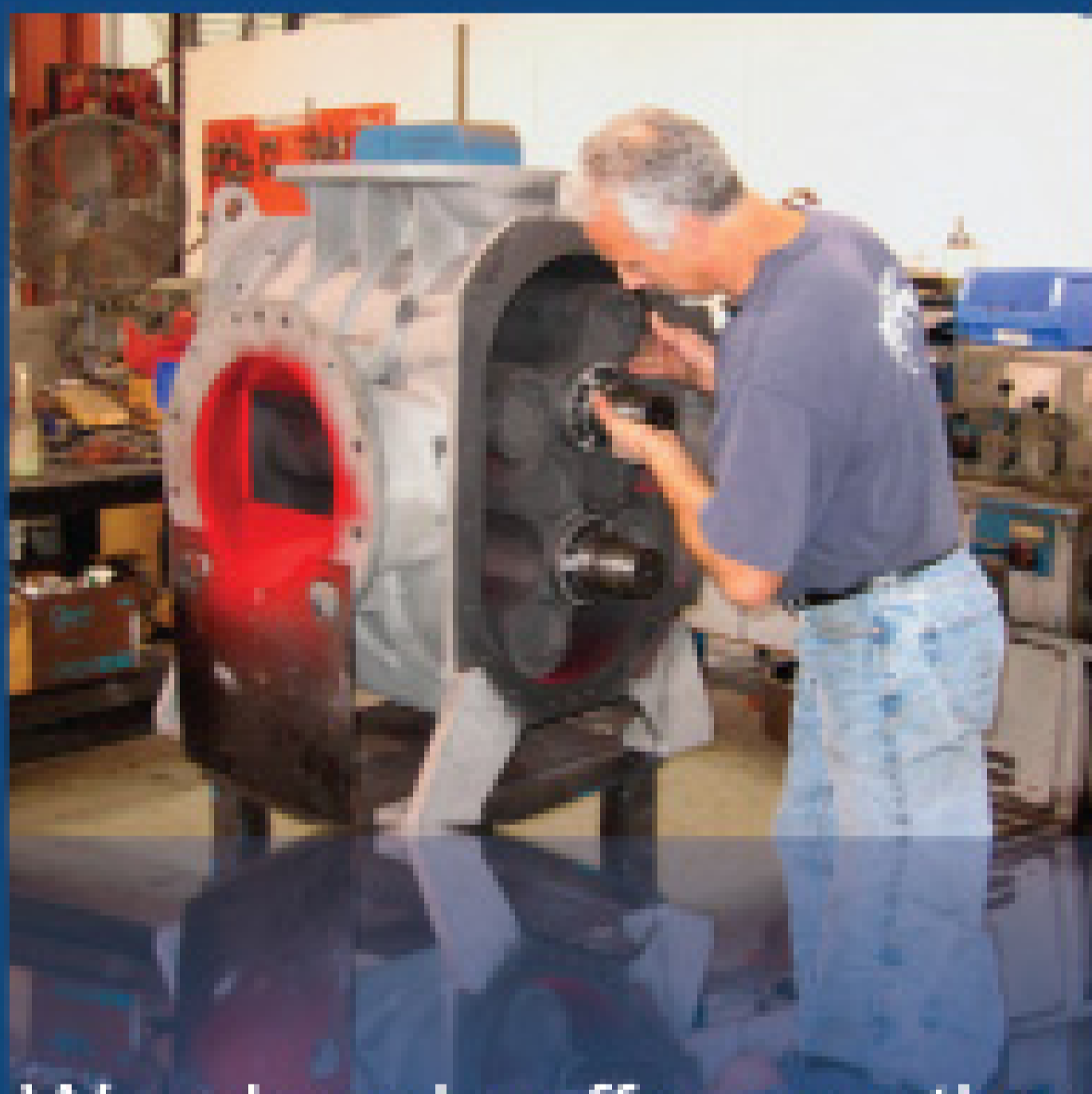

We already offer you the most offloading solutions in the industry, and can custom build our vacuum loaders to suit your exact needs. We can help you find financing. And, with our Right Start program, we personally deliver the keys, provide operator and safety training and give you all the information you need to be more productive from the very beginning.

Beyond that we support your new or hard-used old trucks with fast access to genuine Guzzler parts and a toll-free number you can call for application expertise. We also have regional FS Solution service centers that can provide anything from minor repairs and refurbishing to total rebuilds.

And because we want your business to shine as much as a new truck we will pass along customer referrals every chance we get.

For a demo of a shiny new truck*, go to www.guzzler.com today, or call 1-800-627-3171

*Some qualifications apply.

©2008 Federal Signal Corporation. Listed on the NYSE by the symbol FSS.

GUEZZLER
Subsidiary of Federal Signal Corporation

Your Turn Key Solution To Trucks "Ready to Go"

NEW! IN STOCK!

Factory Assembled For Immediate Delivery
Aluminum Slide-In Vacuum Units
Portable Restroom Service
300 Gallon Waste / 135 Gallon Fresh



\$8,500

F.O.B. Kansas City, KS

NEW! 2007 Peterbilt 340
Cummins diesel, 10 speed trans.
3800 Gallon Aluminum- 2 Compt.
Masport HXL400 Water Cooled
400 CFM Vacuum Pump
Jetter System and Tool Box.

\$129,800 Plus FET
As Low As **\$1780** mo.

Contact:

Glenn "Mac" McCallister
gmmccallister@semotank.com

Donnie Moyers
tdmoyers@semotank.com

Jeff Kalp
jnkalp@semotank.com



Front Lift Tank Hoist
Full Opening Rear Door

2000 Gallon Restroom Tank
Standard pumping system*
Dual service - (2) reels

2008 Sterling - Acterra
26,000 G.V.W, auto trans., air brakes
\$81,177
Lease from **\$1623** mo.



2000 Septic Tank
Masport HXL75
2007 Chevrolet 7500 Series
Automatic transmission, Air brakes

\$76,130 Lease from **\$1522**



800-264-8348 Voice
573-547-8420 Fax
573-450-5196 After Hours
www.semotank.com

SEMO/BAKER **ACRO**

United to Broaden Your Tank Services

456 Semo Lane, Perryville, MO 63775

PUT THE SQUEEZE ON WET WASTE ...
With Belt Filter Press Dewatering

Rentals

Skid Systems

Mobile Units



Made in the USA

Touch Screen Controls
Highest Dewatering Throughputs available
Stainless Steel Construction on Frame, Rollers and pans

Grease Trap Waste

Septage Waste

Industrial Waste

Toll Free: 800-253-0532

Phone: 269-793-7183 Fax: 269-793-8793

127 N. Water St., Hopkins, MI 49328

Contact: Julie VanderMoore at
julie@brightbeltpress.com
269-793-3423
www.brightbeltpress.com



4000 Gallon pumper on a 2007 M2 Freightliner

Tank: Bright finish aluminum-5/16" #5454 shell and heads 76" Dia.

Pumping system: Jurop LC420 water cooled pump
Chassis: Freightliner M2-54,000 GVW, C-7 Caterpillar 300 H.P., 10 speed transmission-14,600 front axle-40,000 air ride rear axle.

2800 Gallon pumper on a 2007 International

Tank: Bright finish aluminum-5/16" #5454 shell and heads

Pumping system: Masport HXL 15 (350 CFM)

Chassis: International 4300-33,000 GVW, 245 HP DT466-RDS 3500-12,000 front axle, 21,000 rear axle.



WHITE RIVER DISTRIBUTORS, INC.
BATESVILLE, ARKANSAS

(800)-548-7219
(870)-793-2374
www.lpgbobtails.com

Black Tie Manufacturing Now Offers 8' Restroom Trailers Starting at \$13,900!

Unlike our competitors, Black Tie standard features include:

- Stair System
- AC/Heat Strip
- Waste Tank
- Hot Water Tank

We CUSTOMIZE and offer attractive Financing Programs.

ASK about our **RE-RENTAL Program!**
WHEN YOU BUY a trailer from Black Tie, you become a rental resource. We don't give you leads. We become **your CUSTOMER!**



© 2008 BLACK TIE MANUFACTURING, INC.

Sample floor plans

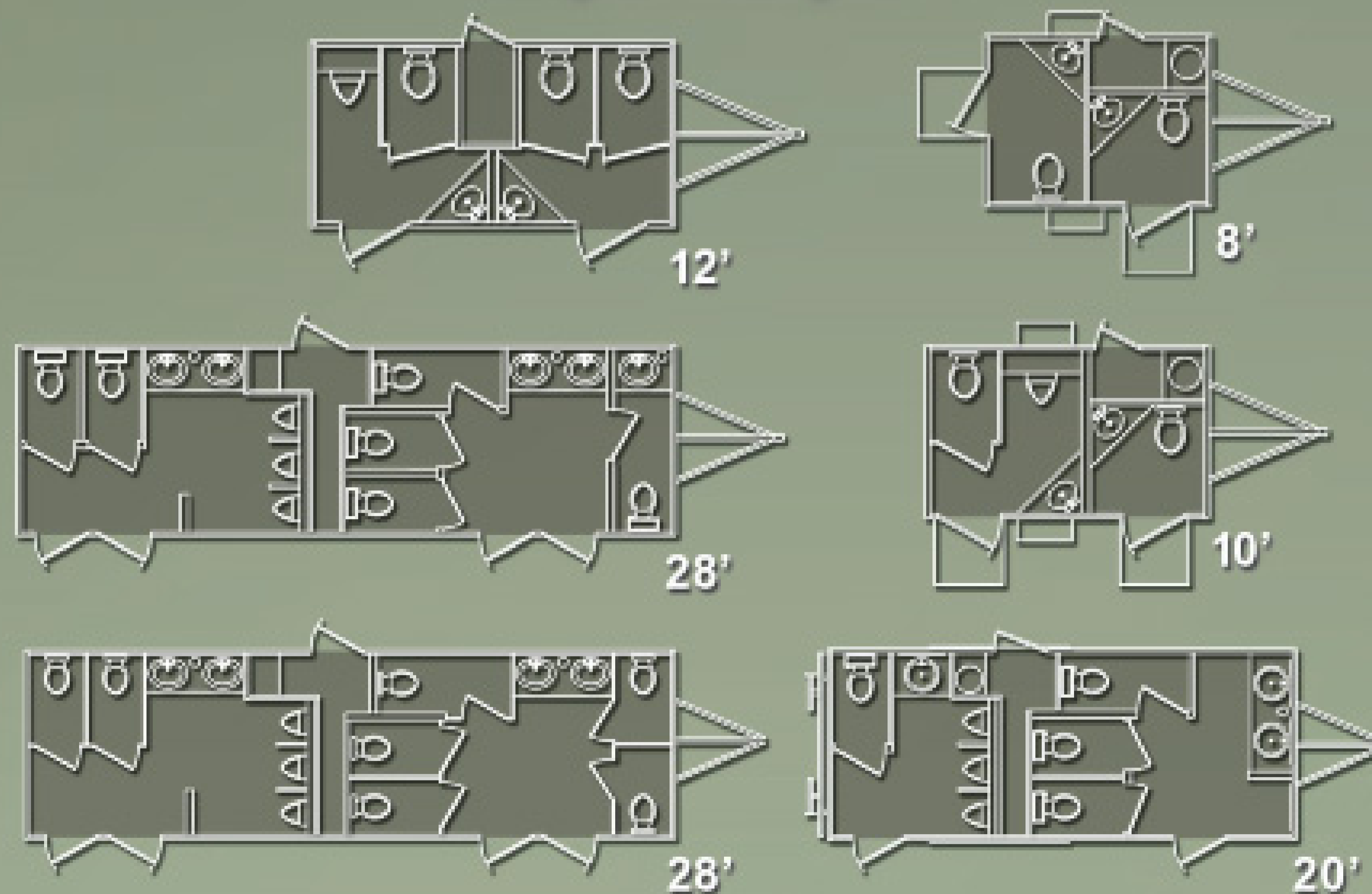

Call **877-253-3533**

BLACKTIEMANUFACTURING.com/diamondshow@blacktiemanufacturing.com



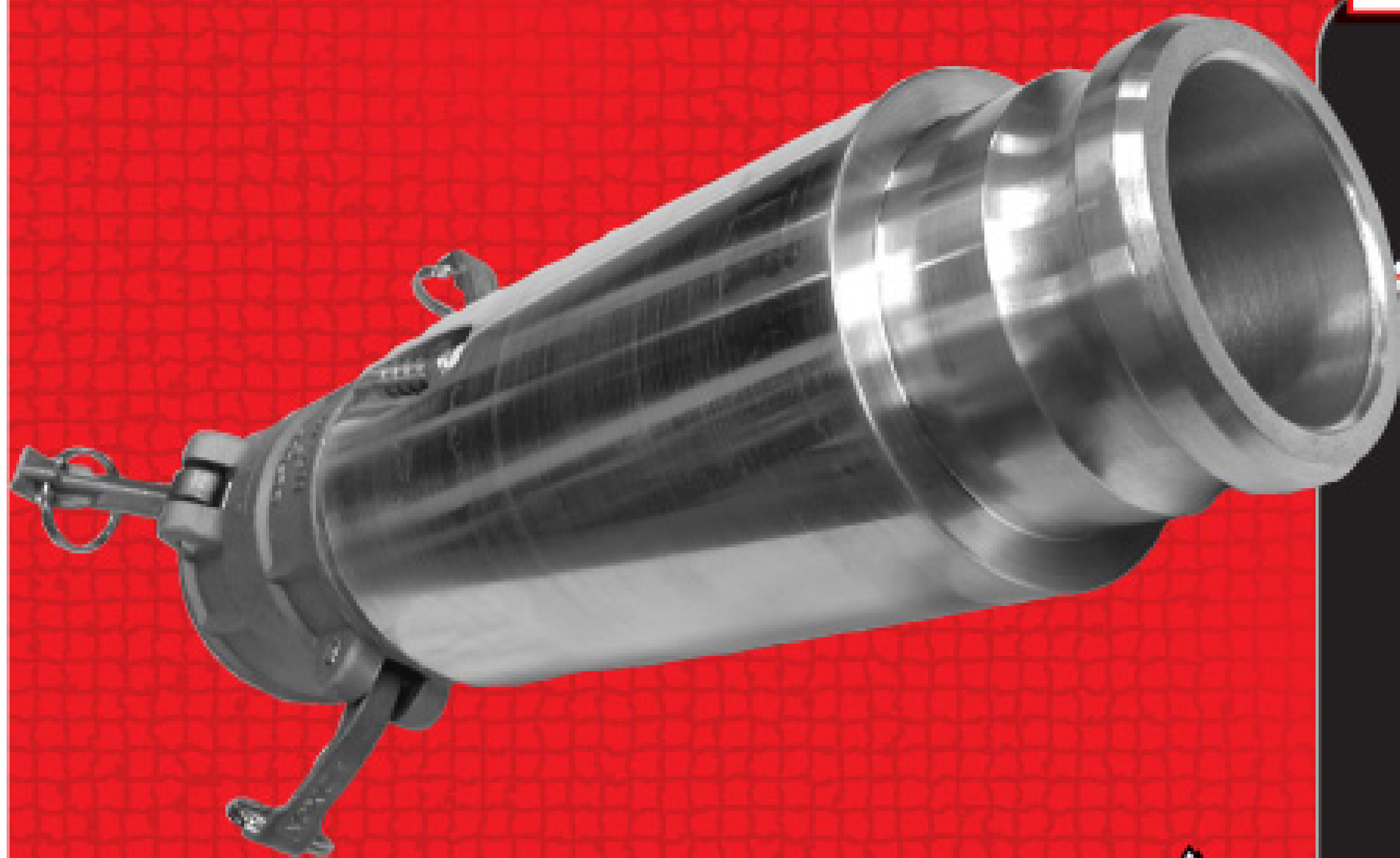

POWER BOOSTER

Pump Deeper – Pump Quicker

Patented Technology for Pumping

PL Pressure Lift Corp

- REDUCE PUMPING TIME
- INCREASE VERTICAL LIFT CAPABILITY
- INCREASE VACUUM PUMP PERFORMANCE
- DECREASE WEAR ON PUMP & EQUIPMENT

CALL TODAY FOR A
FREE DEMO DVD

972.355.0550

www.pressurelift.com

Agitation SAVES Aggravation!

CHOICE OF
2', 4' & 6'
EXTENSIONS



Patent
Pending

**Guaranteed
To Mix Up
Septic Tanks &
Grease Traps!**

High speed rotation
busts the crust and removes solids
right off the bottom of the tank into a
total liquid form

Field tested and proven to mix a
residential tank in 5 minutes or less – takes
approx. 15 minutes to agitate a 5000-10,000
gallon grease trap

**CRUST
BUSTERS**

E-MAIL pete@crustbusters.com
WEB SITE www.crustbusters.com



CHECK OUT OUR NEW
INFORMATIONAL DVD
PUMPER.COM/VIDEO.PHP

Schmitz Brothers L.L.C.
PHONE 763.878.2296
FAX 763.878.2299

1.888.878.2296

ASK ABOUT OUR "BUSTER BRACKETS" FOR TRUCK MOUNTING

When Service Life is Important,
Get the 25-Year NO Rust Guarantee

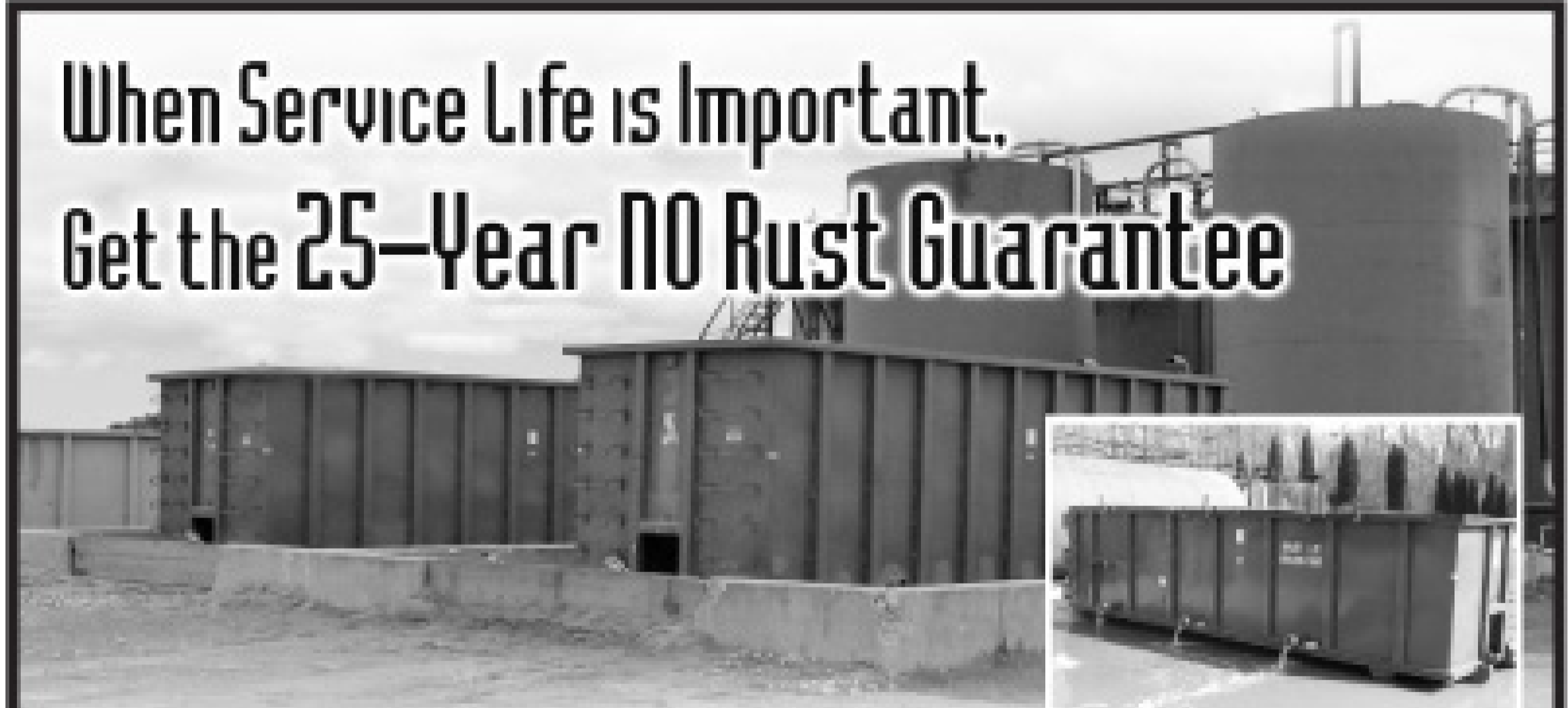

- Dewatering Systems
- Composting Systems (ECS)
- BOD COD Reduction Systems
- Polymer Systems
- Financing Available

**It's Smart to Protect Your Investment,
Get the SMART 25-Year Guarantee!**

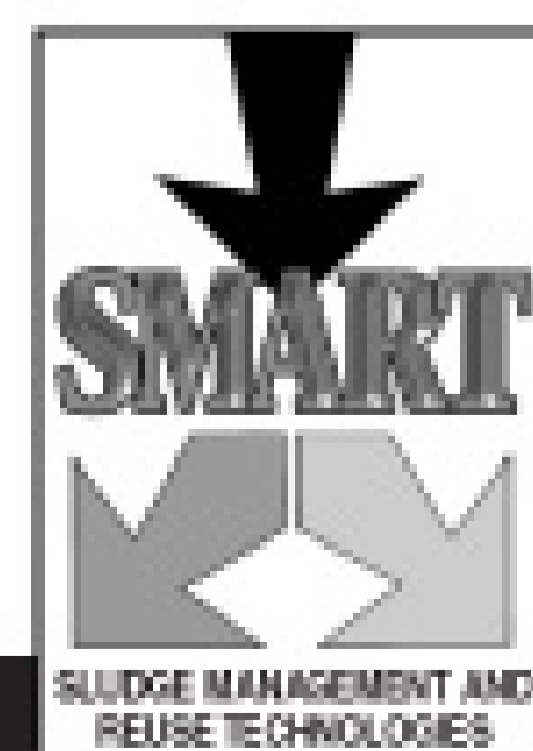

Multiple Purchase Options Available with Financing

If you want experience, give John a call.

1-800-899-1802

P.O. Box 782265 • San Antonio, TX 78278

210-269-3910

www.smartdewatering.com



TRANSPORT TRUCK SALES, INC.

Ask for Scott or Frank – 888-395-7551
After hours call Scott at 816-590-4076



What Does It Take To Be A "Qualified Chassis"?

- ✓ Pass our 12 point checklist. (We send this out with every quote!)
- ✓ Pass a D.O.T. certified inspection!
- ✓ Pass the warranty inspection!

What Does All This Do For You?

- ✓ Nationwide drive train warranty for 2 years/ 200K miles! (restrictions apply)
- ✓ A tough truck that is ready to work as hard as you do!

YOUR TRADES ARE WELCOME!

**Searching For A Brand New Chassis?
 We Have Them In Stock!**



1999 Freightliner FLD12064ST, N-14 Cummins 435HP, 10spd, jakes, 14,600# fronts, only 353K miles, AC, new 3360 gal. steel tank, new liquid cooled HXL-400 Masport vac pump.

Call For Pricing!

2-YEAR 200,000 MILE DRIVE TRAIN WARRANTY



2001 Mack CL-713, E-7 460HP, 18spd, jakes, 20# fronts, 46# rears, double framed, new 3360 gal. steel tank, new liquid cooled HXL-400 Masport vac pump.

Call For Pricing!

2-YEAR 200,000 MILE DRIVE TRAIN WARRANTY



2000 Mack CH613, E-7 380HP, 10spd, AC, jakes, double framed, new 3360 gallon steel vac tank, new Liquid cooled Masport HXL-400 Vac pump.

Call For Pricing!

2-YEAR 200,000 MILE DRIVE TRAIN WARRANTY



2002 International 9400i, Cat 475HP, 10spd, jakes, 14# fronts, 46# rears, double framed, new 3360 gal. steel tank, new liquid cooled HXL-400 Masport vac pump.

Call For Pricing!

2-YEAR 200,000 MILE DRIVE TRAIN WARRANTY



2002 International 9100i, Cat C-12 410HP, 10-spd, jakes, double framed, AC, new 3360 gal. steel tank, new liquid cooled HXL-400 Masport vac pump.

Call For Pricing!

2-YEAR 200,000 MILE DRIVE TRAIN WARRANTY



IN PROGRESS

2004 Freightliner M-2, Cat 210HP, 6spd, 33# GVW, air brakes, AC, new 2300 gallon steel vac tank, new Jurop PN-84 vac pump.

Call For Pricing!

2-YEAR 100,000 MILE DRIVE TRAIN WARRANTY

Delivery Available Anywhere in the Lower 48!!

Bruce is Bullish on Portable Sanitation

New United Site Services CEO says the industry will overcome a slump caused by the housing downturn

As the new president and chief executive officer for restroom services giant United Site Services Inc., Kevin Bruce has an interesting perspective on the portable sanitation industry.

Bruce joined USS in August 2007, bringing with him more than 30 years of senior management experience. His career includes stints as the CEO of Strategic Equipment and Supply Corp., a provider of equipment services and supplies for the food service industry; a senior officer for the North American business unit of SG Lufthansa/Sky Chefs, an in-flight airline caterer; and a senior officer at PepsiCo.

great experience.

From a business perspective, there's clearly an opportunity to bring in elements from other industries — other approaches and disciplines — that can help the company and the industry advance.

Pumper: What trends do you see emerging in the portable sanitation industry? For instance, do you anticipate more and larger national service providers?

Bruce: Interestingly, most industries are not consolidated due to difficulties and the capital required to execute a consolidation. The portable sanitation industry has traditionally had few barriers to entry, but many barriers to consolidation. Local entrepreneurs have been able to go into the business and make a good living with minimal capital investment.

Moreover, there has been little available technology that can differentiate a large player from a small one. But we are starting to see many of those factors change.

Pumper: Do you see a trend toward more technology in terms of, for example, computerized truck routing, GPS tracking, laptop computers in trucks, etc.?

Bruce: I think it all starts with service. Quite frankly, some customers don't care if there's a laptop computer in a truck. Sometimes a clipboard and a route sheet is appropriate technology. It all comes down to analyzing things and making a decision about capital investments versus return on capital. It's up to each individual operator to make that determination.

In our case, USS is moving ahead to implement the first service verification system in the country. Using a combination of third-party and our own proprietary systems, we'll be able to verify delivery and service of our restrooms nationwide. The system allows us to know — on a real-time basis, nationwide — when service is taking place, right down to the Global Positioning Systems coordinates. This allows us to deploy services in a very efficient manner. Additionally, a driver entering a large residential development will know exactly where the units are. And the service is factual and data



THE CAPITAL REQUIREMENTS OR GEOGRAPHIC CONSTRAINTS MAY CREATE BARRIERS, BUT THAT DOESN'T STOP FOLKS FROM THINKING ABOUT BROADER SERVICES. NECESSITY IS THE MOTHER OF INVENTION ... LOOK AROUND AND SEE HOW YOU CAN LEVERAGE YOUR STRENGTHS ELSEWHERE.

Kevin Bruce

based, which helps resolve potential disputes with customers.

Pumper: Do you see increased sanitation regulation on the horizon?

Bruce: Yes, I would expect to see regulations increase. The Portable Sanitation Association International is a leading provider of expertise to many governmental agencies and, as a result, we can really help craft regulations that accomplish a good public purpose while also supporting our industry.

It is clear, for instance, that the health, morale and productivity of construction workers are improved when there are adequate sanitation facilities onsite. The PSAI has been working with the Occupational Safety and Health Administration to change the current regulation of one restroom for every 20 workers to one for every 10 workers. We fully support PSAI in these efforts.

We've seen California adopt hand-washing regulations for jobsites and special events. We expect to see this expand to more states as health officials recognize the positive effect it can have on public health.

In short, we have to be very mindful that we're dealing with a service that, when properly executed, is very low profile. When it's not properly executed, it's not low profile. Philosophically, I'm as free market as you can get — but there's definitely a need for regulations.

Pumper: What is your opinion of standards of professionalism in the industry?

Bruce: Bringing a strong level of professionalism to our industry is helpful to both our customers and our employees, and I would expect to see an ongoing effort for certification and education. New technologies, such as call recording, will help companies improve the

Pumper Interview

By Ken Wysocky

USS has purchased dozens of smaller portable sanitation companies and has ambitious plans to grow via further acquisitions. Its equipment inventory includes more than 156,000 portable restrooms and more than 1,000 service and delivery vehicles. USS does business in more than 50 locations nationwide, providing service throughout the continental United States.

Along with portable restroom services, the company responds to emergencies and disasters with equipment and supplies, ranging from fuel and trucks to fencing and mobile command centers that can operate when phone and power lines are down.

Overall, Bruce is bullish on the portable sanitation industry, and shares some thoughts on the increasing role of technology, the potential for increased industry regulation, the rewards of business diversification and the need for professional standards of service for portable sanitation operators.

Pumper: What prompted you to switch gears and join the portable sanitation industry?

Bruce: I think the industry has a tremendous amount of upside. It provides a service that's often overlooked — until it's needed. You're involved in everything from large special events down to important family occasions, such as reunions, barbecues and such. I think providing that kind of service is a really

skills of their customer service teams.

With call recording, we have a consolidated call center that includes the ability to record phone calls so employees can learn how to better manage customer needs over the phone. We can zero-in on training opportunities, and reward those who are doing a good job.

Pumper: What do you think the future holds for the special events and construction markets?

Bruce: I think these will remain very important areas of emphasis, regardless of the current situation in the residential homebuilding segment. We have contracts with large national customers that are an important part of our growth. That said, we also work hard to capture every small event possible. We'll serve any customer from a backyard wedding with one portable toilet to a huge air show with hundreds of portable toilets and a fleet of restroom trailers.

Pumper: What are some logical areas where portable restroom operators can diversify?

Bruce: Well, for USS, diversification includes septic, stormwater pollution prevention programs, erosion, fencing, power, recre-

ation and special events. Different market segments require different services.

PHILOSOPHICALLY, I'M AS FREE MARKET AS YOU CAN GET — BUT THERE'S DEFINITELY A NEED FOR REGULATIONS.

Kevin Bruce

For example, when we provide emergency response for a disaster, we see urgent needs for potable water, power generation and showers. Special events, on the other hand, often require temporary fencing, barricades, mobile storage and temporary offices. Some of these services overlap market segments, while others are somewhat unique to a particular segment.

Let's put it this way: A rising tide lifts all boats. The name of our company is United Site Services, and there's a reason for that — we're not limited to portable sanitation. We look for ways to help our customers meet their particular needs. We do that by asking them about their needs ... and I would encourage all operators to think that way.

The capital requirements or geographic constraints may create barriers, but that doesn't stop folks from thinking about broader services. Necessity is the mother of invention ...

look around and see how you can leverage your strengths elsewhere.

Pumper: What challenges does the portable sanitation industry face going forward?

Bruce: The most obvious challenge is our nation's homebuilding downturn. Each region of the country has been affected differently. Red-hot markets, such as California and Arizona, have seen the biggest corrections.

But other areas, like the Northeast, have been affected less because housing represents a smaller part of the portable sanitation market. Other strong markets, such as Houston, haven't been as affected by the subprime lending market problems because strong underlying economic growth sustains demand for housing.

The long-term forecasts for population growth in the United States remain strong, and this is the underlying driver of housing demand. We don't see the current housing market creating a fundamental change in the demand for portable sanitation; it's more of a short-term, over-supply issue. Our industry will have to work through this dynamic. Growth will begin again, but on its own timetable. ■

PORTABLE TOILET
SERVICE UNITS
SLIDE IN UNITS
HOISTED UNITS
ROLL OFF UNITS
CUSTOM UNITS

www.pikrite.com

Do Your Shopping At Pik Rite and Save



pikrite

Manufacturing & Sales - 60 Pik Rite Lane - Lewisburg, PA 17837

1-800-326-9763

10280 Brecksville Road Brecksville, Ohio 44141



R.A. ROSS N.E., INC.

INDUSTRIAL & TRUCKING BLOWERS • VACUUM PUMPS • SALES, SERVICE, & INSTALLATION



We have a **FULL SERVICE REPAIR SHOP** capable of servicing and repairing a wide variety of different makes and models of blowers and vacuum pumps from all your top manufacturers including
**Tuthill/MD • Drum • Gardner Denver • Cycloblower • Duroflow • Sutorbilt • Roots • Hibon
 Fruitland • Moro • Masport • Wittig • NVE Challenger • Jurop • Battioni • Presvac
 Blackmer • Roper • Ranger • Viking**



NVE FRUITLAND CHELSEA
 A DIVISION OF Parker



Vacuum Pumps • Components • PTO's • Hydraulics • Valves • Manways • Gear Boxes • Mufflers • Silencers • Gauges • Camlocks • Hose

TOLL FREE 1.800.678.4581 PHONE 440.546.1190 FAX 440.546.1188 EMAIL RAROSSNE@RAROSSNE.COM WEBSITE WWW.RAROSSNE.COM



DENVER TRUCK SALES

Nobody Beats Our Quality!



1996-2001 Western Stars

435 Cats, Jake, 18 speeds 46,000 LB rears on Hendrickson air suspension. New 3360 gallon tank, HXL-400 Masport pump, serviced and checked.

From \$64,950 plus F.E.T. on the tank



1996 IHC 9400

14,000 LB f/a 3406 Cat, Jake, 15 speed transmission, 46,000 LB rears Hendrickson air suspension. New 3360 gallon tank HXL-400 pump serviced and checked from

\$62,950 plus F.E.T. On the tank

Complete Line of Pumps and Parts



1997 KW T-800 Series

60 Detroit, Jake, RTLO-16713 transmission, RT46160 46,000 LB 4.33 ratio, New 3360 gallon tank, Masport HXL-400 pump, New paint serviced and checked.

\$66,950 plus F.E.T. on the tank



2001 Freightliners FL 120

C15 475 Cat, Jake, RTLO-18918 trans, RT46160 on Hendrickson spring suspension, 4-way locks. New 3360 gallon tank HXL-400 pump

\$79,950 plus F.E.T. on the tank

Easy Financing and Lease-To-Own WAC!

**Denver Truck Sales • 5293 Vasquez Blvd. • Denver, CO 80216
 Phone: 303-291-0960 • Fax: 303-291-0244 • www.denvertruck.com**

**"DON'T BE EMBARRASSED AGAIN!"
 HOW AWFUL...**

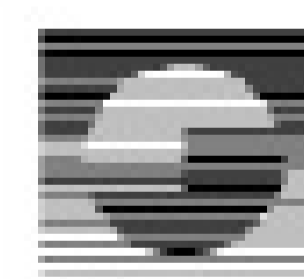
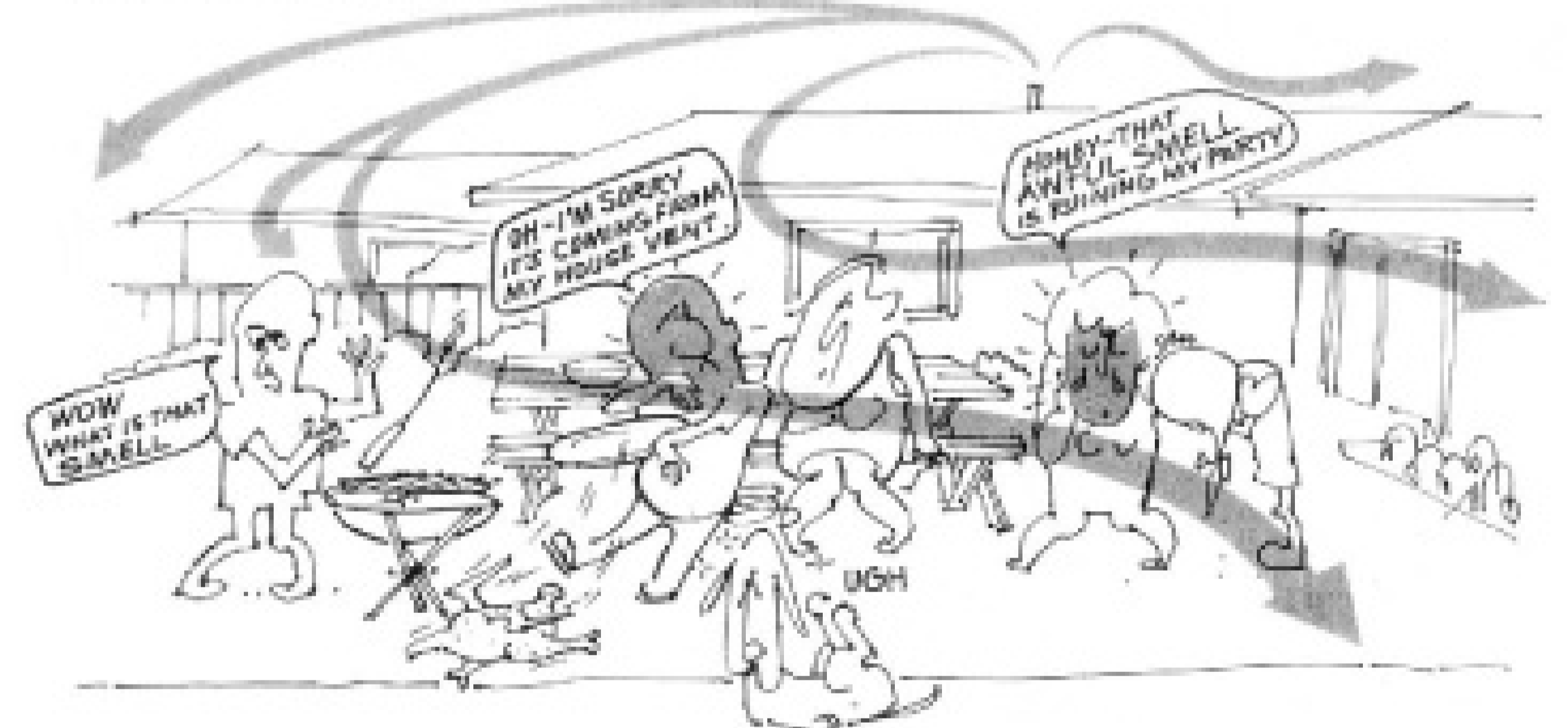

800-622-8768
 sweetair.com

SWEET SEPTIC SYSTEMS, INC.
 5701 Mother Lode Drive • Placerville, CA 95667
 Fax: 530-622-1087

SWEET AIR™ FILTERING DEVICE

PAT PENDING

HOW WONDERFUL...

UPC Approved

Sweet Air



**America's Sales Leader In Aluminum
Truck Mounted Tanks & Tank Trailers
nationwide - worldwide
Stock Tanks & Trucks
Financing & Lease Plans**



1-800-971-7657

www.tstllc.com

email us from our website



1700 Restroom Tank

PORTAVAC 400 fresh / 1300 waste

Masport HXL 4 w/ pre-filter, Burks wash down, Hot shift PTO w/remote, 4" Discharge, Unit hauler and tow package.

2008 Kenworth T300

22,000 GVW, Auto trans., hydraulic brakes

\$74,900

Monthly lease plans from ...\$1,027.

2000 Gallon Restroom Service

Masport HXL 4 w/ pre-filter, Burks wash down, Hot shift PTO w/remote, 4" Discharge, Unit hauler and tow package.

2008 International M7

26,000 G.V.W. Auto trans., air brakes.

\$77,900

Monthly lease plans from ...\$1,558.

6300 Gallon 'Brushed Aluminum'

Full length hose trays, 3 manholes, 4" low profile primary, 3- 5" sight eyes in rear head, 4" inlet/discharge, Betts L.E.D. lights, bumper...much more.

from...\$55,000 Plus FET

F.O.B. Arthur, IL

3800 Gallon (2) Compt Septic Tank

Masport HXL400 water cooled Jetter system with reel

2008 International 4400 Auto transmission

\$116,247 Plus F.E.T.

Monthly lease plans from ...\$2,324.



SUCCESS COMES IN



TUFWAY



TAURUS



NO MATTER
WHAT YOUR
OPERATION REQUIRES, WE
HAVE YOUR SUCCESS IN MIND.

Whether your business caters to construction, recreation, or special events, the Satellite/Synergy family of portable restrooms has you covered. From the dependable and economical Tufway to the most sophisticated flushing restroom in the industry, the High Tech II Deluxe Flush, we've taken the guesswork out of success. We can help you choose the right solution for the job – for a single unit or an entire fleet.

► Contact your area manager to discover what we have in mind for your success.

ALL SHAPES & SIZES.



MAXIM 3000



HIGH TECH II

CONTACT YOUR AREA MANAGER AT:

1 (800) 328-3332

VISIT US ON THE WEB AT:

SatelliteIndustries.com | PortableToilet.net



SYNERGY WORLD



PARTNERSHIPS MADE FOR SUCCESS

WHY LET YOUR COMPETITION BEAT YOU?



Hundreds of portable restroom operators are using the Gamajet 9 Cleaning System and giving themselves a strong competitive edge. By cutting cleaning times, eliminating hand scrubbing and offering a much cleaner restroom, they're taking business away from you.

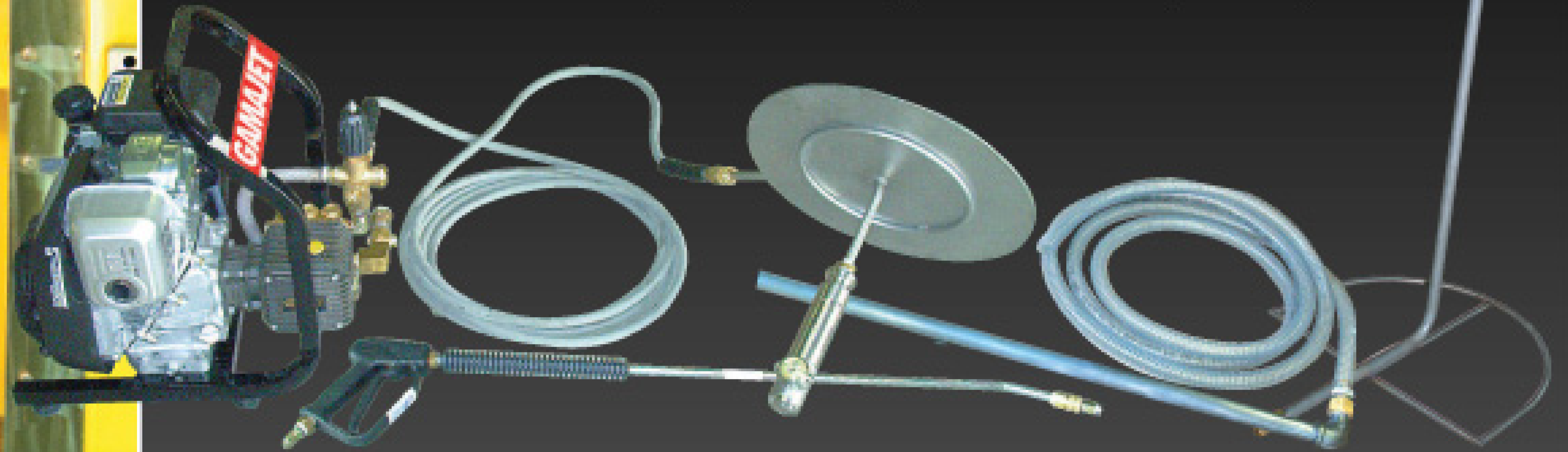

GAMAJET 9 PORTABLE RESTROOM CLEANING SYSTEM

Unmatched cleaning convenience • Proven by hundreds of operators
Hands-free cleaning - including the holding tank • Satisfaction guaranteed
Get a Gamajet 9 and cleaner units, before your competition does.

1-877-426-2538

www.gamajet.com

604 Jeffers Circle Exton, PA 19341

GAMAJET®

Gamajet Cleaning Systems, Inc.

We Squeeze the Crap Out of Water™

Rotary Thickening and Dewatering

Simple systems that are
totally enclosed, compact
and easy to operate.



**PRIME
Solution
inc.**

PH: 269-673-9559

www.primesolution1st.com

Made In USA

435 GALLON VACUUM TANK



- 1/4" Aluminum Construction
 - Conde Super 6 Pressure Vac Pump with 5.5 hp Honda Electric Start
 - 12 Volt Water Pump
 - 300 Waste/135 Fresh
 - 25' Hose and Wand
 - 2" Sight Eyes in Waste
 - Sight Tube on Fresh Water
 - Completely Self-Contained
 - Ready to Work
- *OTHER SIZES AVAILABLE***

Robinson Septic Service Inc.

125 Rockrimmon Dr., Bellefonte, PA 16823 • f: 814.353.0263 • email: honeydippers@aol.com

1.800.252.3848 • www.robinsonseptic.com

We have names for people like you

Galbreath

Toter

Accurate

Cusco

Parts Place

Mountain Tarp

Pioneer

There is a name for a company offering the best products and selection in the waste handling equipment industry - **Wastequip**. No matter what you call them, Wastequip is the name to contact to find the top product names and widest selection all under one roof. Partner with Wastequip and you get access to each of our nationwide facilities at your fingertips. Each one is ready to be your business supplier and company resource. Support like that means streamlining your business in the name of increasing profits to your bottom line. *One call, one relationship, one name...Wastequip.*

1.877.GOT.WASTE

www.wastequip.com



WASTEQUIP

Nationally known for personal service

CUSCO



**“The Right Solution”
Complete line of Liquid Waste
and environmental equipment.**

HITTING the BOOKS

Mike Ellingson is a one-man crew serving eastern Washington State, pumping septic systems and providing portable sanitation. (Photos by Melissa Ellingson)

**M-n-M
Sanitary**
Republic, Wa.
(509) 775-2115

50,000 GYW

(509) 775-2115

Profile

M-n-M Sanitary Republic, Wash.

Owner: Mike Ellingson

Years in business: 13

Service area: About a 75-mile radius around Republic in northeastern Washington

Specialties: Portable sanitation and septic tank cleaning

Affiliations: Portable Sanitation Association International

Web site: www.mnmsanitary.com



WASHINGTON

Stidious Washington pumper does his homework and overcomes financial and technological challenges

By Ken Wysocky

When Mike Ellingson married his wife, Melissa, in 1999, he drove to the wedding in a Ford F-350 restroom service truck — fully stocked with toilet paper.

“I was working the day of the wedding, so I drove my work truck to the ceremony,” he recalls. “I had an ample supply of toilet paper inside, which was a big mistake. I wasn’t really thinking — I was just trying to get there.”

Of course, by night’s end, there was more toilet paper on the truck than inside it.

That anecdote illustrates two things that have helped Ellingson build a successful portable sanitation and septic pumping business in Republic, a small town in rural northeastern Washington: Work is an integral part of his life, even on special occasions, and he

learns from his mistakes. “When I started out, I had no clue,” he candidly admits. “The whole business thing was one big learning process. But I like to learn how things work, and it’s always interesting to me to see how other businesses work, and apply what they do in my business. I’m always trying to improve.”

“Over the years, I’ve learned a lot and come a long way.”

HUMBLE BEGINNING

Ellingson’s education in Business 101 began in the early 1990s, when he started working for 10-7 Septic Service, a small portable restroom and septic tank cleaning outfit run as a side business by a retired police officer. (In case you’re wondering, “10-7” is police call code for “out of service.”)

“The owner wanted to get out of the business, so his son and I were going to buy it,”

Ellingson explains. “But then the son got married and moved away, so that left me to run the business, which consisted of about 100 accounts, most of them septic service customers.”



Ellingson, working with a unit, started his business by buying out a former employer.

“THEN YOU LEARN MORE ABOUT IT AND REALIZE YOU DO MAKE YOUR OWN HOURS — 24 HOURS A DAY, SEVEN DAYS A WEEK! BUT I’VE NEVER BEEN AFRAID TO WORK HARD, SO THAT WAS A GOOD THING.”

Mike Ellingson

Ellingson was 19 years old when he took over the business in 1994. His motivation at the time was very simple:

“As a young, dumb kid, I just loved to drive trucks,” he says with a chuckle. “Plus, I guess owning your own business seemed kind of neat — you know, be your own boss and make your own hours.

“Then you learn more about it and realize you do make your own hours — 24 hours a day, seven days a week! But I’ve never been afraid to work hard, so that was a good thing.”

A good thing, indeed. On a typical day, Ellingson rises at 5 a.m. and tries to catch up on paperwork at his home office. On three days of the week, he then heads out to service restrooms — about 30 a day. The accounts are far apart; it’s common for Ellingson to drive 250 miles a day.

On the other two days of the week, Ellingson cleans septic tanks. He handles emergency septic calls on Saturdays and Sundays.

“I work an average of 60 hours a week, and 80 hours in summer isn’t out of line,” he notes. The only respite is during the slower months from January through April.

STEADY GROWTH

After he got married, Ellingson changed the name of the business to M-n-M Sanitary, which stands for Melissa and Mike. Business grew, slowly but surely.

“I had no master plan, though I wish I would’ve,” he says. “It all just kind of happened. I just kept doing good work and kept answering phone calls.”

At first, Ellingson obtained more and more special event work — local festivals and celebrations, dirt-track car races and county fairs. Then, in 2001, the U.S. Forest Service asked M-n-M to provide portable restrooms for a camp of firefighters battling a forest fire. That

led to an annual renewable contract to provide the forest service with restrooms from May through October.

“One year they wanted more than 100 units, and I had only 10 available,” he says. “To avoid buying more, I rented units from companies in Spokane (about 125 miles southeast of Republic).”

As business mushroomed, so did the company’s inventory. Ellingson now owns about 135 standard portable restrooms. About 110 are from Satellite Industries Inc., and the rest are PolyJohn Enterprises Corp. units.



Ellingson operates with two trucks. The septic pumper is a 1993 Kenworth T600 that he built out himself with a 3,000-gallon steel waste tank and a 135-gallon aluminum freshwater tank that used to be a fuel tank. It’s equipped with a Masport H75V pump. The restroom service truck is a 2001 Chevrolet 3500 equipped with a 600-gallon waste/100-gallon freshwater/275-gallon deodorant mix steel tank that he bought from another service provider.

Ellingson also owns a trailer that carries a 725-gallon plastic freshwater tank. It’s used to

Pumping, drain cleaning and associated work make up about half of Ellingson’s work. The other half is portable sanitation.



Left, the septic rig for M-n-M Sanitary is this 1993 Kenworth T600 with a 3,000-gallon tank. It’s pulling a utility trailer carrying RIDGID drain cleaning machines.

clean out vault toilets in the area’s national forests. In addition, he carries RIDGID K-1500 and K-50 sectional cable drain cleaning machines in a small cargo

trailer.

Portable restrooms make up about half of M-n-M’s total revenue, and septic tank cleaning adds another 25 percent. Two smaller business sidelines, drain cleaning and waste disposal, round out the balance.

LEARN FROM MISTAKES

Making a go of the business was anything but easy during the early years, Ellingson remembers.

“For the first seven years, I also worked at a local mine and as a postal service employee to make ends meet,” he says.

One of the biggest stumbling blocks was lack of financial know-how. For instance, he borrowed money early on to buy new restrooms, something he rarely even considers now.

“I don’t finance anything anymore,” he explains. “A low debt load is a lot less risky. For instance, if I’d get hurt, I wouldn’t be able to make the payments on a loan.

“On one hand, if you don’t borrow money, your business will grow slower. But we’re not



Ellingson runs his restroom route with this 2001 Chevrolet 3500 with tanks for waste, freshwater and pre-mixed deodorant. He services about 30 restrooms per day and runs three routes a week.

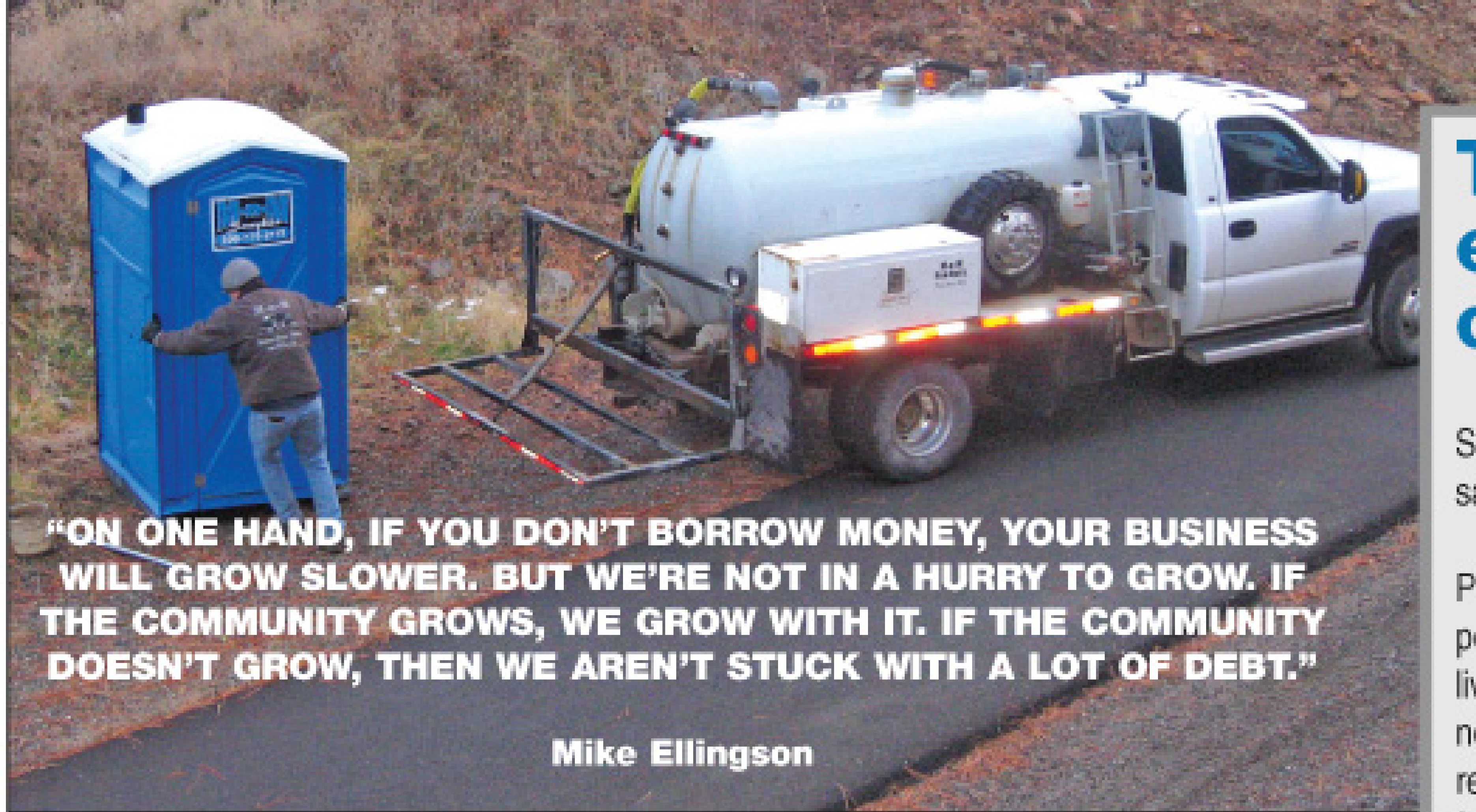

"ON ONE HAND, IF YOU DON'T BORROW MONEY, YOUR BUSINESS WILL GROW SLOWER. BUT WE'RE NOT IN A HURRY TO GROW. IF THE COMMUNITY GROWS, WE GROW WITH IT. IF THE COMMUNITY DOESN'T GROW, THEN WE AREN'T STUCK WITH A LOT OF DEBT."

Mike Ellingson

Most of Ellingson's restroom inventory is from Satellite Industries, with additional units from PolyJohn Enterprises Corp. He serves the U.S. Forest Service and many events in northeastern Washington.

in a hurry to grow. If the community grows, we grow with it. If the community doesn't grow, then we aren't stuck with a lot of debt."

Ellingson has also learned it's critical to keep up with paperwork, especially invoices. He also found out that knowing the costs of doing business is essential to proper and profitable pricing.

"You've got to know what your costs are before you even make a dime," he emphasizes. "And you can't forget to consider your own wages in that equation. I think that a lot of times, people underprice themselves."

Ellingson points out that a good accountant is invaluable to any small businessman. Initially, Ellingson hired one just to handle federal income tax payments.

"Now our accountant reviews our profit-and-loss statement on a monthly basis and

keeps us on track. They're helping us spend money in the right places and be sure we have enough money to pay quarterly taxes," he says.

"Before that, I was going through life blind and not paying much attention to money," he continues. "I'm a worker, not a bookkeeper. But now I'm more of a bookkeeper, and I don't mind it because I know what my expenses are, which makes it easier to price correctly instead of underbidding yourself."

SERVICE SPURS GROWTH

Fortunately, Ellingson didn't need any lessons in customer service. Meticulously cleaned restrooms are a high priority, and customers take notice.

"You have to take time to clean the toilets, not just wash them out," he asserts. "And don't forget to wash the doors. When you sit down on a toilet, the only thing you see is the door, and if

it's dirty, people think that's really gross."

Good service provides another benefit — less money spent on marketing. While Ellingson admits that being the only operator in the area helps immensely, he still has to do a good job to obtain repeat business.

Technology advances even a remote one-person operation

Embracing new technology is one way that M-n-M Sanitary increases efficiency, profitability and customer satisfaction, says owner Mike Ellingson.

For example, Ellingson recently purchased a Global Positioning System to help him navigate his way to new portable restroom and septic tank cleaning customers who live in the sparsely populated region he serves in far northeastern Washington. As the only septic and portable restroom operator in a rural area, he services everything from farms to remote bus stops.

"I grew up here, and there are still a lot of roads that I don't know about," Ellingson says. "Also, there's not a lot of good road signage, or address numbers on houses.

"The GPS gives me peace of mind, more than anything," he adds. "There's a lot less anxiety when I'm trying to find a place, and you think you should be there and you're not, or you're wondering if you've gone too far and don't know about it."

Ellingson now can tell customers with reasonable accuracy what time he'll arrive for a service call because the GPS system estimates how long it will take to get to a destination. That's a benefit customers really like, he says.

Back at home, Ellingson also invested in accounting software to help him with everything from finance management to invoicing to estimates.

"QuickBooks is a very simple program — I taught myself how to use it," he notes.

Two years ago, Ellingson hopped on the information superhighway with a sophisticated Web site. The site highlights the various services his company offers and includes photos of the various restrooms available. He includes a Web page with value-added information about how septic systems work, how often they should be pumped, basic "dos-and-don'ts" for onsite system newcomers."

"I don't do any marketing at all, except for the phone book and a Web site," he observes. "Business just seems to come to me. And during summer, I'm usually so busy that I'm not worried about getting new customers.

"But it's a lot of feast and famine; you work your butt off in summer and can't wait for winter, then come winter, you can't wait for summer so you can start earning some money again."

Busy or slow, Ellingson enjoys one constant in his life as a hard-working sole proprietor: his continuing education in the world of business.

"I'm always trying to improve," he says. "Every day I learn something new." ■

Ellingson washes down his rig after dumping a load at a local disposal site.



MORE INFO:

Masport Inc.
800/228-4510
www.masportpump.com

PolyJohn Enterprises
800/292-1305
www.polyjohn.com

Ridge Tool Co.
440/323-5581
www.ridgid.com

Satellite Industries Inc.
800/883-1123
www.satelliteindustries.com

WHAT DO YOU NEED TO STOCK YOUR BUSINESS NOW?

- lower payments...
- longer terms...
- less interest...
- deferred payments?

Why limit your options to inflexible delayed payment plans when you can choose the options that are best for you?

FLEXIBLE FINANCING* on trucks, restrooms and hand-wash stations enables your money to work harder for your business.



POLYPORTABLES

Call your regional manager at **(800) 241-7951**.

PRO-VAC

INDUSTRIAL PUMPOUT STATION

There is no substitute for professional pumping equipment

- Ideal for grease trap pumping
- Extremely maneuverable, can go just about anywhere
- Pumps fast, 60 GPM, 60 gal. capacity
- Will not blow 15 amp breakers
- Will not overflow
- Has odor control technology
- Comes complete with everything needed for pumping
- Factory direct with factory support

Call today for complete information and specifications on the industries' most complete portable pumpout unit.

Toll Free 800-367-0972

Westmoor Ltd.

P.O. Box 99
Sherrill, New York 13461

NOW 30% More Power!



On The Web At: www.westmoorltd.com, e-mail: pumps@westmoorltd.com

RABCO 800-2-DRAINS

Hose Hook

Safer, Easier Way to Pick Up Suction Hoses!



Waste Water Analysis

pH Meters

Dissolved Oxygen



Multiparameter

BOD

Free & Total Chlorine

Soil Samplers

3/4" Dia x 6.5" Long
Stainless Steel
Cylinder Carbon
Steel Bits.

Rubber Coated
Cross Handle
Stelite Hard
Surfaced Cutting
Edges

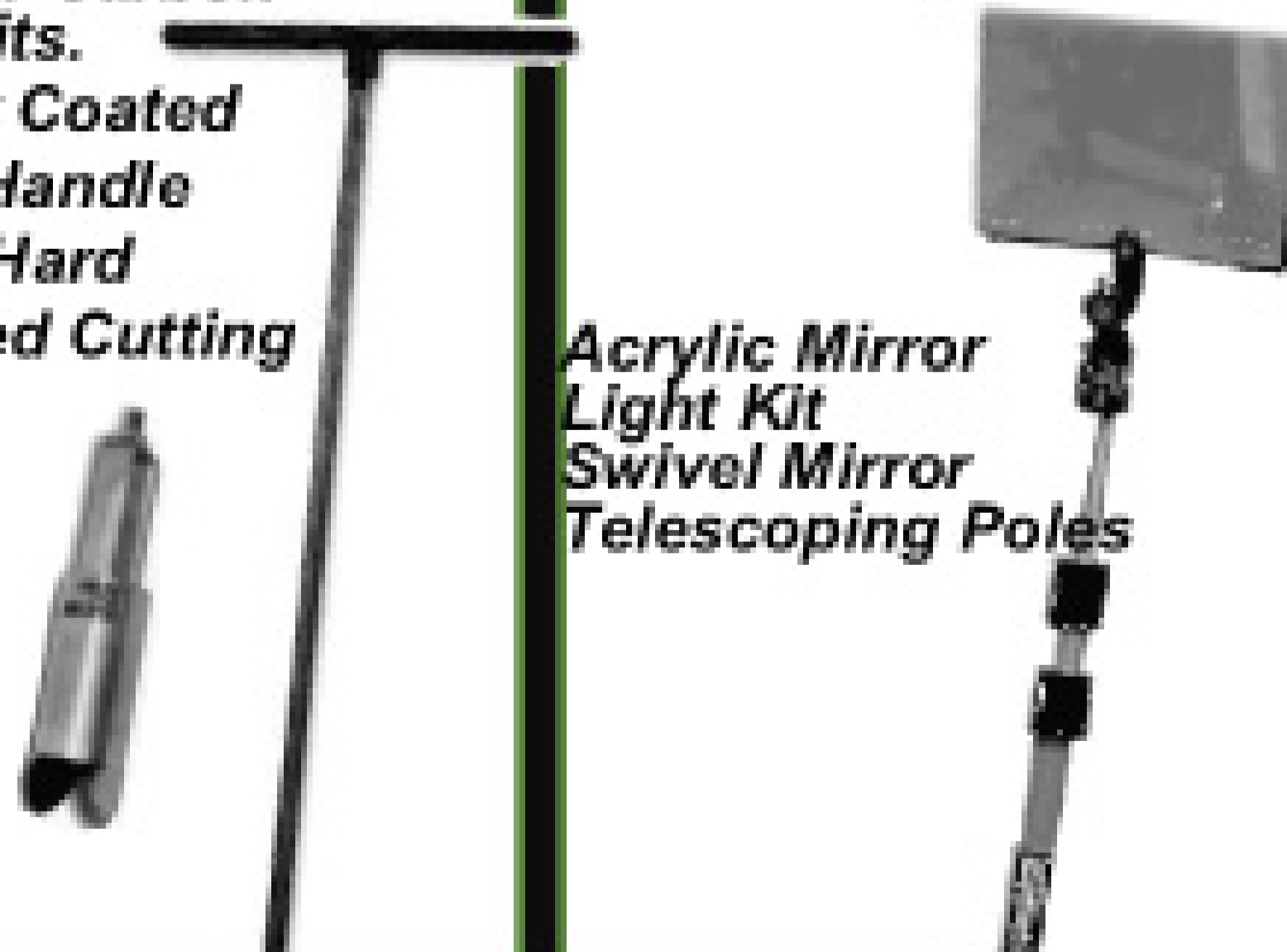

Extend-A-Vue™

Safely Inspect Septic
Tanks, Manholes
Confined Spaces!

Acrylic Mirror
Light Kit
Swivel Mirror
Telescoping Poles

Sludge Judge™ Tank Samplers

Accurate Readings
of Settled Solids
in a Variety of
Liquids.

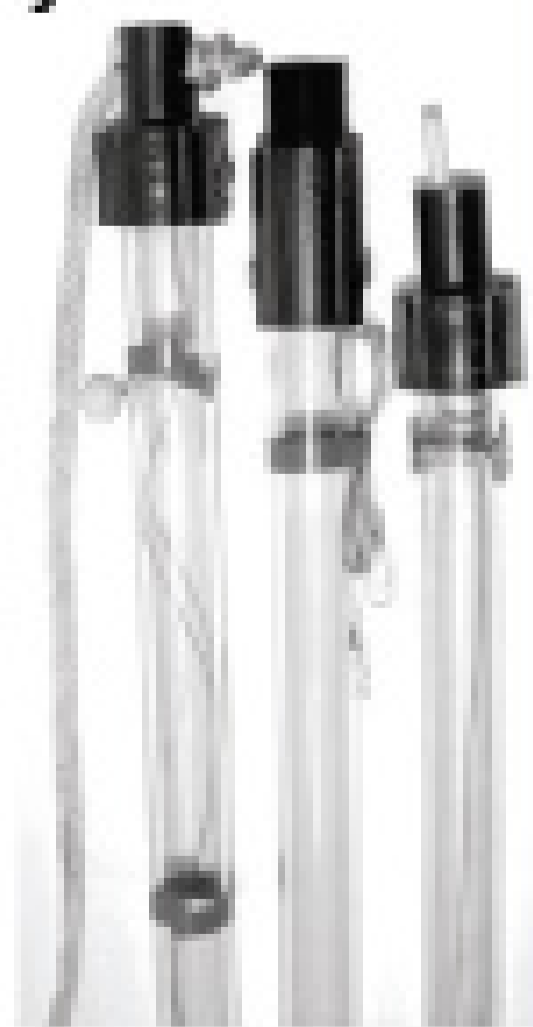

PumperSupply.com

RABCO

Tel: 203-230-1693 · 800-237-2467
Fax: 203-230-2956 · 800-332-3335

**PT
&E**

PRECISION TANK & EQUIPMENT CO.

www.precisiontank.com | 1.800.258.4197

CENTRAL ILLINOIS Manufacturer Celebrating 40 years of steel and stainless steel tank equipment innovations. Tank sizes from 100 to 5000 gallons in stainless steel or steel.

Manufacturing plants in Virginia and Athens, Illinois bringing quick completion of your pumper truck!

40 years of excellence!

PRECISION TANK & EQUIPMENT CO.



Standard models or
custom built units

Single or multiple
compartments

1.800.258.4197

Strong like bull.



The most durable and affordable restroom available, the Global from Hampel.

No bull.



Engineered for strength, durability and value.

www.hampelcorp.com • 800-549-1558

JUST ONE MORE CHANCE FOR SHOW SPECIALS!

- Fabricated to the best industry standards using the highest quality products available
- Custom configurations to your specifications
- VISA, American Express, MasterCard, & Discover
- Fast, same day shipping, low freight rates



**ATLANTA
RUBBER &
HYDRAULICS**

1640 D Sands Place
Marietta, GA 30067
Toll Free: 800.282.6272
Phone: 770.955.5225
Fax: 770.955.2377
e-mail: dragsdale@atlantarubber.com

FACTORY AUTHORIZED SERVICE

for: *ROOTS-DRESSER, ROBUSCHI, HIBON, H&H,
HOLMES and KAISER Blowers*

**Fast Delivery - Large Selection - Best Price - Great Service
New - Rebuilt - Core Exchange**

**Exchange Units - Most Models
of Roots, Robuschi, Hibon,
Holmes, H&H and Kaiser**

- ◆ Roots 1125 Trinidad
- ◆ Roots 1021 DVJ
- ◆ Roots 1024 RAS
- ◆ Roots 1021 RAS
- ◆ Roots 824 RCS
- ◆ Hibon SIAV 840
- ◆ Hibon SIAV 8702
- ◆ Hick Hargreaves 4084

**New Blowers & Pumps
Available From POWER VAC**

- ◆ Roots
- ◆ Robuschi
- ◆ Hibon
- ◆ Hick
- ◆ Masport
- ◆ Moro
- ◆ Aerzen



hibon  **KAISER**

ROBUSCHI



1-800-822-4887

W228 N2792 Duplainville Rd. • Unit G. • Waukesha, WI 53186
(262) 542-8989 • Fax: (262) 542-6262 • www.powervacinc.com



Tanks For Your Business

Mid-State Tank manufactures stainless steel and aluminum tanks and has become a well-known and respected supplier for the agricultural, aviation, industrial and fire services, as well as pressure/vacuum tanks.

Mid-State Tank holds an ASME stamp and is D.O.T. approved.



Mid-State Tank Co., Inc.

PO Box 317 • Sullivan, IL 61951
(800) 722-8384 • Fax: (217) 728-8384
www.midstatetank.com



Septic Tank Riser, Lid & Safety Pan™

FREE FREIGHT ON FULL CARTONS!

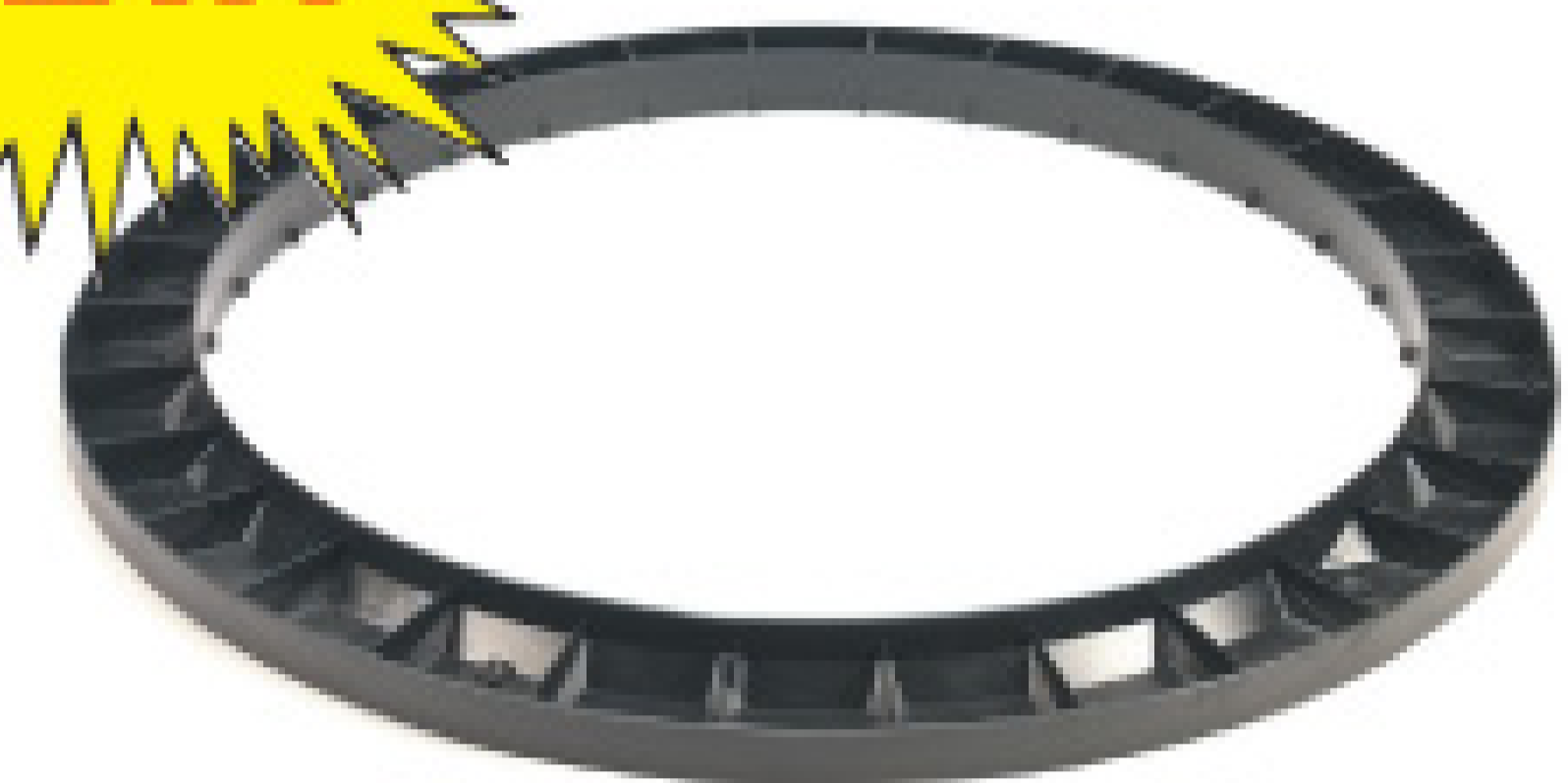
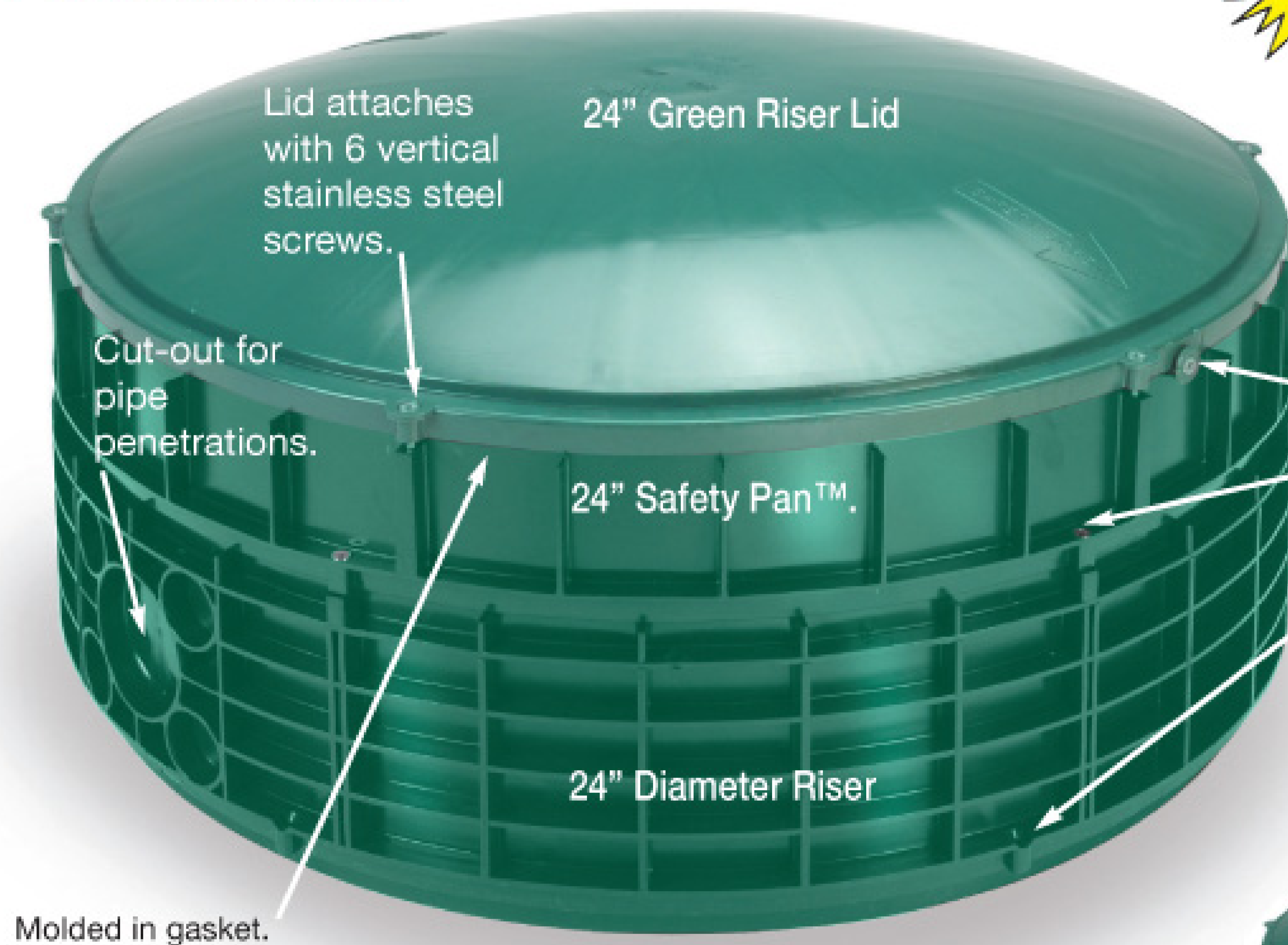

Tank Adapter Ring

New - Horizontal Safety Screw.

Safety Pan™ to Riser attachment with 6 vertical stainless steel screws.

Riser to Riser attachment with 6 vertical stainless steel screws.

Patent Numbers
 5,617,679 &
 5,852,901; other
 pats. pending.

Riser Lid

with Molded-in gasket.
 Available in 12", 16", 20" and 24" diameters.

Concrete Lid w/handle

Safety Pan™

Safety Pan™ available in 16", 20" and 24" diameters.

Riser

For septic tanks. Stackable in 6" increments. Available in 12", 16", 20" and 24" diameters.

Tank Adapter Ring

For mounting riser flush to top of tank when casting-in is not an option.



Molded in gasket.

Available in 12", 16", 20" and 24" diameters.

Effluent Filters

Patent Numbers
 6,319,403; D 431,629; other
 pats. pending.

800 GPD
 ANS/NSF
 Standard 46

4" Sch. 40 &
 SDR-35

EF-4
 4" Filter

1500 GPD
 ANS/NSF
 Standard 46

4" Sch. 40 &
 SDR-35

244 ft. of
 1/16" filtration
 area.

EF-6
 6" Filter

Gas/Solids
 Deflector



One-Piece Tank Seal

For concrete Septic tanks and D-boxes.
 Accepts pipes from 1-1/2" to 4".
 Mounts with or without concrete flash.



TS-4-RUBBER TANK SEAL
 (will hold 10psi)
TS-4PRO TANK SEAL
 (will hold 5" vacuum)



Free Freight: 32¢

Patent No's
 4,951,914,
 5,624,123
 & 5,711,536;



the
Choice
 is yours

Get exactly what you want
 and need in a restroom
 trailer. ACSI gives you
 the options...

www.restroomtechnology.com
1-800-927-2271

Inventory of New & Used!

We Build Pumper Trucks

1,500-3,400 Gallon Vacuum Trucks

Featuring a 1500 Gal. Gooseneck Vacuum Tank

CHECK OUT THESE OPTIONS:

- Under 84" height
- Light tare weight
- Controls operated from ground level
- Moveable axles to distribute weight
- Inside tank coating
- Pintle/ball hitches
- Choice of brake systems
- Any brand of vacuum pump



Redneck Trailer
Parts Dealer



Moro Pump
Dealer

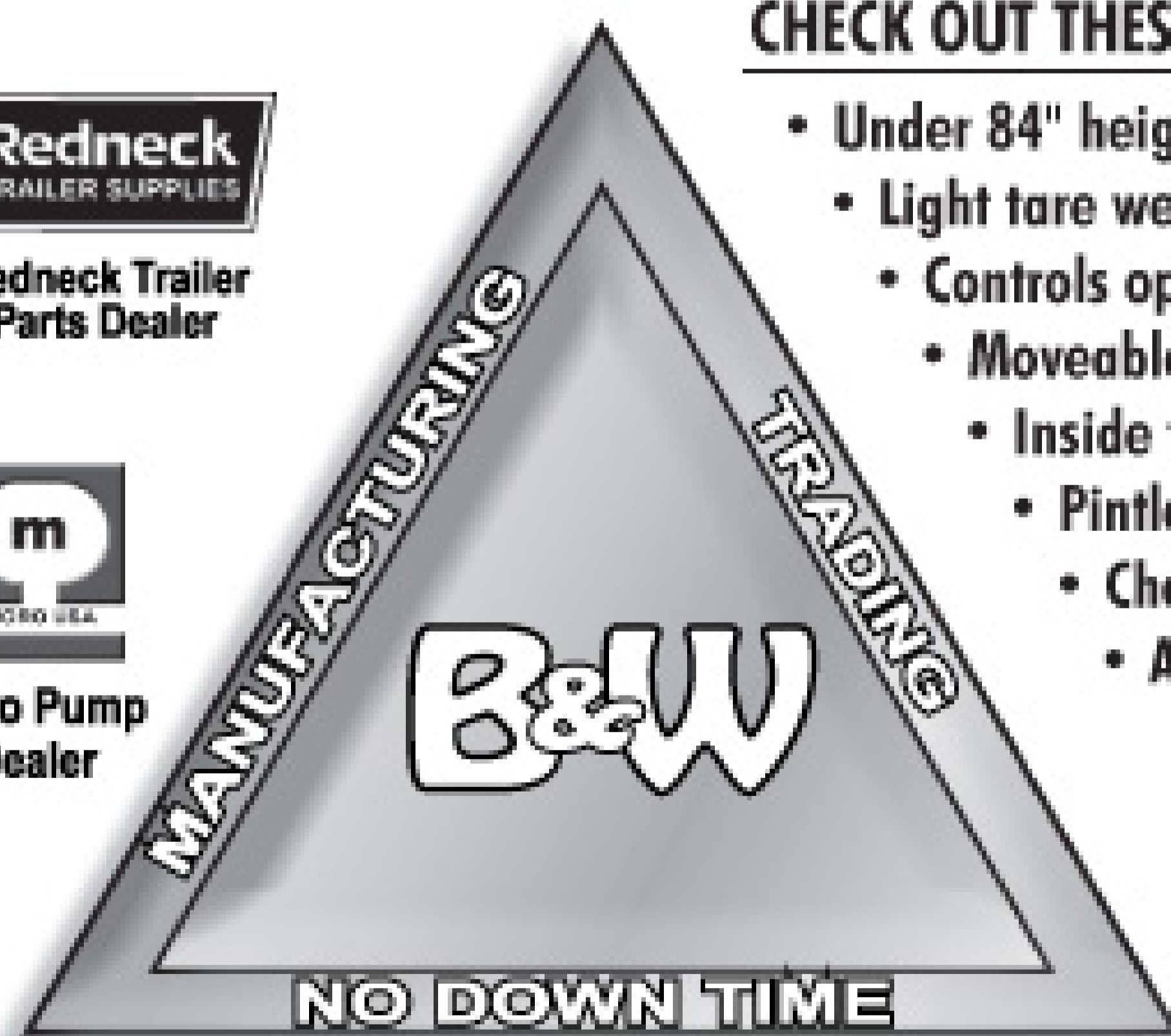

ALL TANKS ARE MADE IN THE USA
ALL TANKS ARE COMPLETED AND THEN PRESSURE TESTED



B&W MANTRAD INCORPORATED
 4000 E. Jackson • Macomb, IL 61455

309-837-1989 • fax 309-837-1919 • bandwent@macomb.com

*40 Years
Experience*

**B&W .. Because Nobody
Has Time for Down Time**

**CALL TODAY
FOR INFORMATION OR PRICES
ON TANKS, PUMPS AND ALL PARTS**

T **RANSWAY** *SYSTEMS INC.* **PROFESSIONAL VACUUM EQUIPMENT**

Toll-Free: 800-263-4508

DELIVERY SERVICE
AVAILABLE

T: 905-578-1000

F: 905-561-9176

314 Lake Ave. North
Hamilton, Ontario L8E 3A2

WE PAY BORDER CROSSING CHARGES • LEASING? WE CAN REFER YOU TO THE SPECIALISTS • OVER 40 YEARS IN BUSINESS

HEAVY-DUTY EQUIPMENT THAT WORKS!

**LET 45 YEARS
OF EXPERIENCE
WORK FOR YOU !**



ProCAM™ DVD

Color Mini Camera Inspection System with DVD Player/Recorder

- 10.4" Color LCD Monitor
- 110 VAC or 12 VDC Operation
- Power Control Unit Weighs Only 17 Pounds
- Optional Rechargeable Battery Pack Kit Available
- Optional Pro Eye Color Self-Leveling Camera Available



Optional Rechargeable Battery Pack Kit Includes:

- (1) 14.4 V NiMH Environmentally Friendly Battery
- Dual Bay Fast Charger with Carrying Case
- Additional Batteries Available
- Charges on Both AC & DC



ProCam DVD Ultra with Reel & Optional Battery Pack Kit

UEMSI
PIPELINE CLEANING & TELEVISION EQUIPMENT

Corporate Office: 1.800.666.0766 • Fax 1.800.691.0031
www.uemsi.com • E-mail: info@uemsi.com

We Accept:

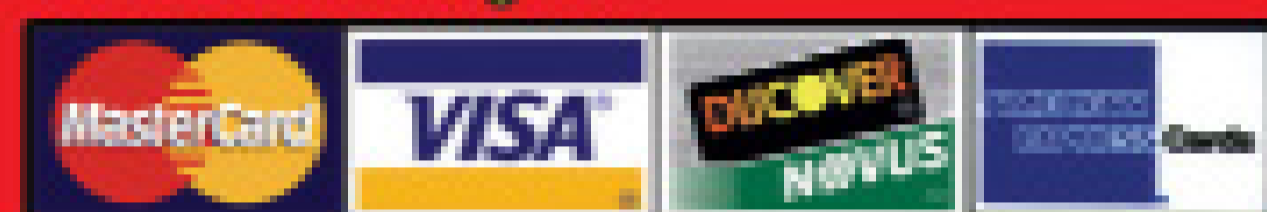

Oil Skimmer Sucking up money for vacuum trucks

Many times when oil is spilled, vacuum trucks are called for clean up. A vacuum truck using our skimmer will always get the job over a conventional rig because a vacuum truck using our skimmer is:

- 97% efficient
- Environmentally efficient
- Cost efficient
- Equipment efficient
- Simple and easy to use
- Recovers all types of oil
- Ideal for pits, lagoons and industrial oil recovery operations

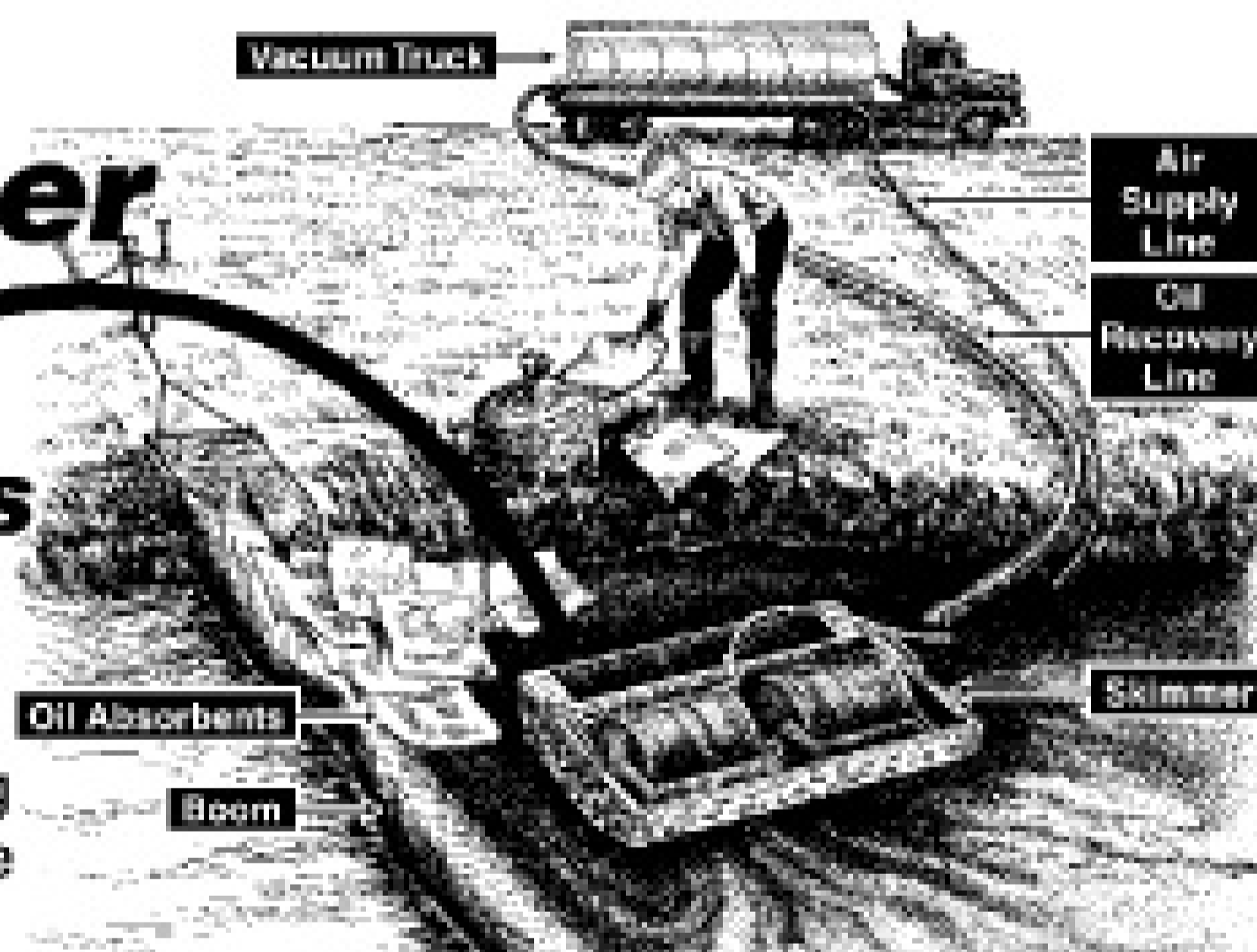

DrumIt The drum filling vacuum head with auto shut off



DrumIt quickly connects to vacuum truck. Ideal for chemical, oil or hazardous materials. Works on liquids, solids and sludges.

Trailer Mounted Vacuum Systems are Our Specialty



PACS is designed for easy dumping with fully opening rear door.

- Wide flotation tires and surge brakes for highway or off-road
- Various models available
- Standard units normally in stock
- Built with heavy-duty components
- Low maintenance with simple controls
- Designed for ease of towing
- Automatic mechanical shutoff
- Efficient and easy to use
- Extra strong frame withstands the difficult conditions of remote locations

Call for more info.
(618) 382-2525

www.elastec.com

ELASTEC
AmericanMarine
FOR INNOVATIVE ENVIRONMENTAL PRODUCTS

121 Council St., Carmi IL 62821 • Tel: 618-382-2525 • Fax: 618-382-3610 • Email: elastec@elastec.com

PU03-05

**Post Show
Specials**

VSI
VACUUM SALES, INC.

51 STONE RD. • LINDENWOLD, NJ 08021

Low Interest Rate Financing Available!



Stock # 4648V 2003 Sterling Model LT9513 Cab & Chassis with a Vac-Con Model VPD4216LHA/1300 combination vacuum loader & high pressure sewer cleaning system. Less than 95,000 miles. **\$169,000**



Stock # 13234 Pipehunter Truck mounted jetting unit, 3,000 psi at 50 gpm with a 1,000 U.S. gallons water tank, rear mounted hose reel with a Jet Eye Camera system mounted on a 2006 GMC TC6500 cab & chassis. Less than 6,000 miles. **\$175,000**



Stock # 13297 2008 Peterbilt 340 with a new Presvac 3,600 gallons (US), aluminum vacuum tank unit. **\$126,000** Includes F.E.T.



Stock # 13294A 2008 Sterling LT9500 with a New Presvac 3,500 gallon c/s DOT certified 407/412 vacuum tank dump type with full open rear door. Presvac PVB750 vacuum pressure pump. **\$305,000** Includes F.E.T.



Stock # 13329V 2001 Freightliner C120 cab and chassis with a NEW Presvac 3,200 gallon DOT 407/412 Certified Vacuum -pressure tank. **\$115,000** Includes F.E.T.



Stock # 13273 B 2007 New Acro Trailer 7,000 U.S. gallon aluminum vacuum pressure tank. **\$79,000**



Stock # 5008V 1990 Presvac 5,000 stainless steel D.O.T. with pump & engine. **\$69,000**



Stock # 13289 2007 Chevy C7500 cab & chassis W/ a New 1500 waste & 500 water aluminum portable. **\$78,000**

Sales, Parts & Service

888.VAC.UNIT

(888.822.8648)

www.VacuumSalesInc.com

Strength in Numbers

Atlanta-area companies join hands to trade ideas on dealing with an economic downturn and raising professional standards

By Ken Wysocky

Challenged by an economic downturn and concerned about a lack of industry professional standards, a group of veteran portable restroom operators in metropolitan Atlanta has banded together to share equipment, ideas and resources.

“Jeff Wigley (owner of Pit Stop Portables Sanitation Services Inc.) and I thought it was a good time to see if other companies out there



Name:
Jeremy Hawkins
Company:
Blu-John.com Portable Sanitation
Location:
Cumming, Ga.
Years in Business: 7

Jeremy Hawkins

would be interested in forming a group that could come up with ideas to help each other out — explore possible synergies and efficiencies,” explains Jeremy Hawkins, owner of Blu-John.com Portable Sanitation in Cumming, Ga.

Other operators enthusiastically agreed, and the Metro Atlanta Work Group, or MAWG, was born. To be a member, a company must have at least five years of operating experience in Georgia and be an active member of the Portable Sanitation Association International, which advises the group to be sure matters are conducted in a professional, above-board manner, says Hawkins.

The group has met about a half dozen times since forming in 2007. It is only a work group, not a formal association or organization. The only forbidden subject at meetings is pricing, Hawkins emphasizes.

“Our goal is not to exclude people, but rather include the professionals who are going to be here in the long run,” notes member Claudette Orzech, owner of Happy Can in Atlanta.

Adds Hawkins, “We want to raise the operating bar so that every Tom, Dick and Harry can’t jump into this business overnight.”

So far, members agree the collaboration is a resounding success. Whether it’s sharing equipment, covering parts of each others’ routes when it makes sense geographically, bouncing ideas off each other or just simply commiserating, the group’s efforts are helping each member weather the economical storm.

“There’s no reason why other companies around the country can’t do this, too,” Hawkins notes. “In fact, we plan to stay together even after the economy rebounds to help strengthen our industry in our marketplace.”

Here’s what other members had to say about the group’s benefits.

“I agreed wholeheartedly when I was asked to join,” recalls Mark Slade, who says the meetings offer a valuable opportunity for members to talk about changes in the industry.



Name:
Mark Slade
Company:
Comfort Zone Portables
Location:
Alpharetta, Ga.
Years in Business: 10

Mark Slade

“This group will be much more beneficial in two years than it is now. I think we’ll be invited to air our views on legislation and regulations affecting our industry, which probably wouldn’t happen without this group. Even this early, there’s a little bit of clout here.”

Lewis Carter

“We all run into each other from time to time and talk, so with the downturn, it started to make more sense ... to trade ideas — war stories, if you will — and see if we can’t create efficiencies on our own profit-and-loss statements.”

Experienced operators know how to “batten down the hatches” during an economic downturn and reduce costs by cutting company fat that’s built up over the years. Inexperienced operators, however, tend to cut prices as a knee-jerk reaction, which then induces a ripple effect that harms everyone, he notes.

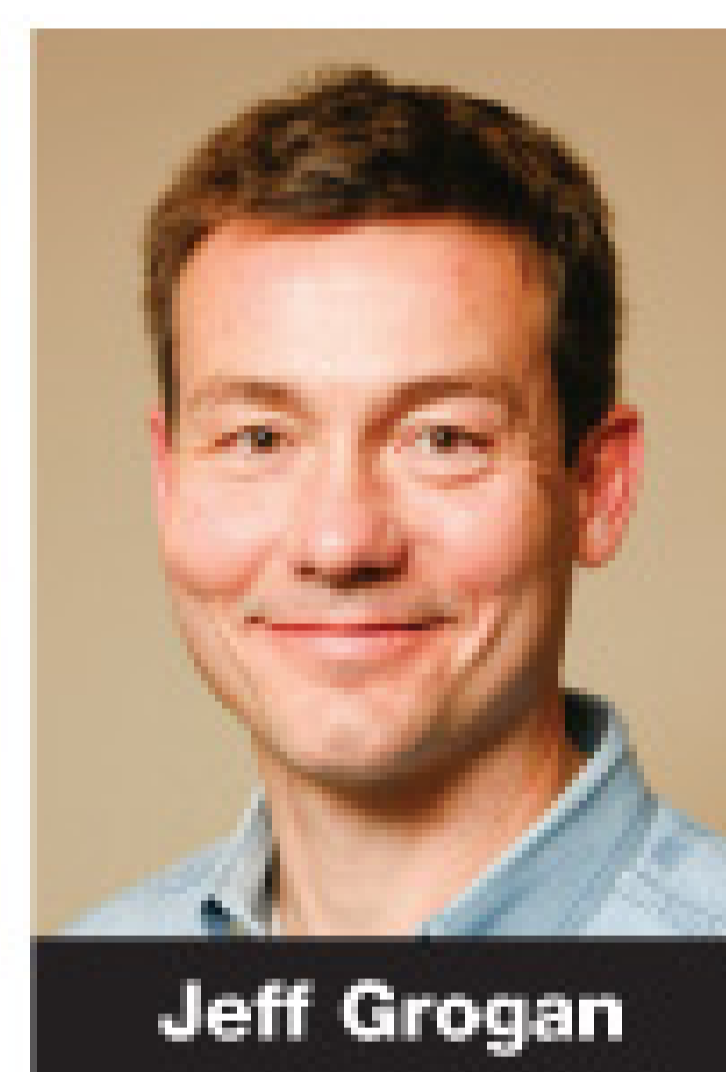

Name:
Jeff Grogan
Company:
Grogan’s Sani-Service Inc.
Location:
Cumming, Ga.
Years in Business: 20

Jeff Grogan

“I was excited about joining,” says Jeff Grogan. “It gave me comfort knowing I wasn’t the only one having a hard time.”

The information exchanged at meetings led Grogan to change from fuel cards good for only one brand of gasoline to generic

cards that can be used at many different gas stations. That way his drivers can shop for the best fuel prices on a daily basis.

“Even a few cents a day adds up when you’re fueling several trucks,” Grogan notes.

Because of the meetings, Grogan now buys products in larger quantities to get volume price breaks.

“I’m real excited to be a part of the group,” says Chuck Shropshire. “I think it would have come about even without an economic downturn — it’s been on the verge of happening for a couple years.”

As for benefits, Shropshire says the group has created some synergies on servicing routes, as well as borrowing equipment he otherwise would have been forced to buy at a time when money is tight.



Name:
Chuck Shropshire
Company:
Johnny On the Spot Inc.
Location:
Cartersville, Ga.
Years in Business: 20

Chuck Shropshire

"Right now, I'm servicing units for other members and they're servicing units for me, so it's a win-win situation all the way around," he comments.

One of the best benefits of the meetings was a unified push to get route drivers PSAI-certified, Shropshire adds.

"The certification process was very successful at my company," he notes. "It defined our processes, our cleaning procedures and our overall standards ... and gave my drivers much more pride in what they do than they had before. Prior to this certification process, they didn't realize that they could be recognized for meeting a professional standard in this industry."



Name:
Claudette Orzech
Company:
Happy Can
Location:
Atlanta, Ga.
Years in
Business: **7**

"It's a wonder we didn't think of this earlier," says Claudette Orzech about the group's formation.

One of the group's main goals is to elevate the status of the industry in Georgia, she points out.

"Specifically, we're working with lobbyists to pass legislation regarding operating procedures — things like drivers and certification, waste disposal, safety and insurance requirements," Orzech says. "We want to ensure smaller companies that come into the area know what the minimum standards are, and we want contractors to know that we're certified and are handling liquid waste properly."

Orzech also agrees that the PSAI certification class was a huge success, and she plans to use the certifications as a marketing angle to differentiate her company from those without certified drivers.

"We had 65 drivers turn out for the certification," she notes. "Without this group, there wouldn't have been that many in the class."

"Just getting to know each other has been fun," observes Terri Wigley. "It's hard to put a value on that ... it's good to know you're not alone."

Terri Wigley said that because of the meetings, Pit Stop is doing more volume buying to take advantage of price breaks.

"I think there's even a possibility in the future of ordering supplies

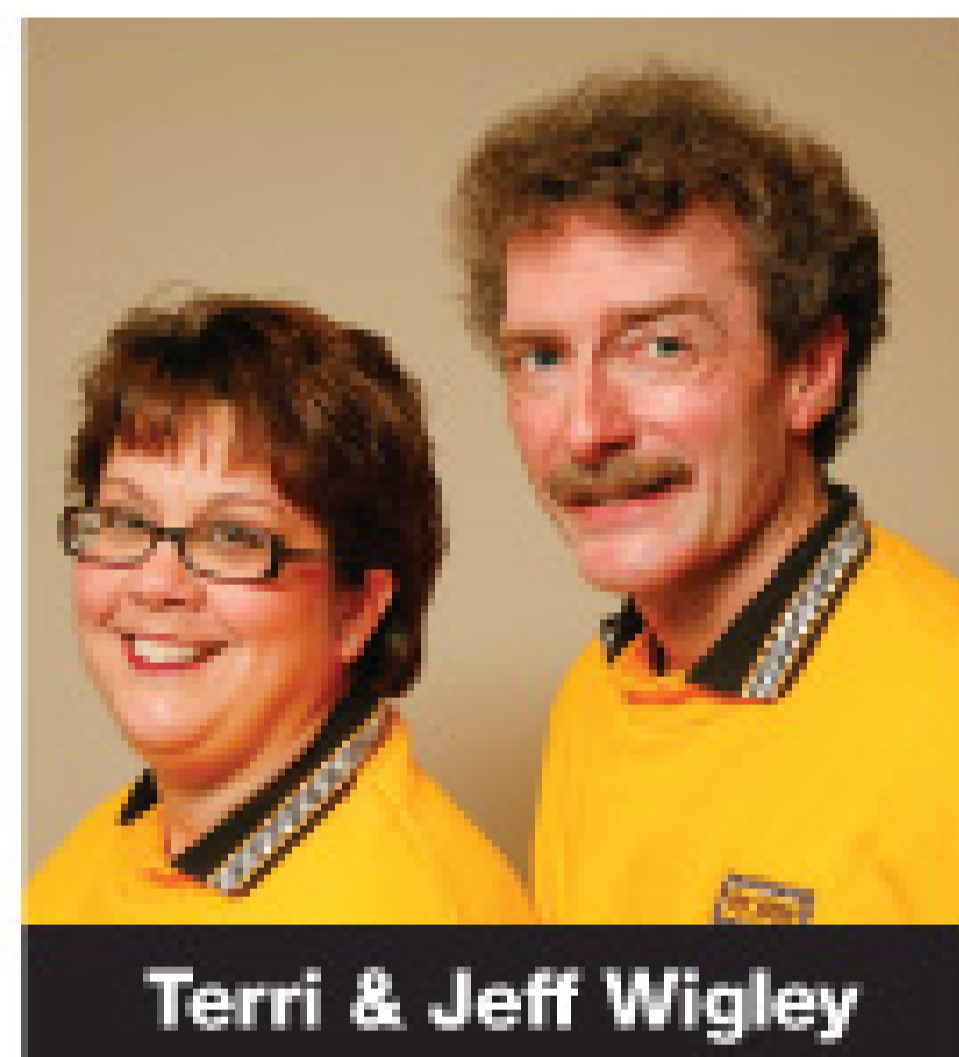

Name:
Jeff and Terri Wigley
Company:
Pit Stop Sanitation Services Inc.
Location:
Hiram, Ga.
Years in
Business: **13**

Terri & Jeff Wigley

as a group," she points out.

Jeff Wigley said one of the main reasons to form the group was to dispel the notion that portable restroom service is a commodity.

"If it was a commodity, and all service was the same, then customers could just pick the cheapest company and keep going," he explains. "But we all feel there's value in what we do. There should be a difference when you use a PSAI-certified company. It's all about professionalism."

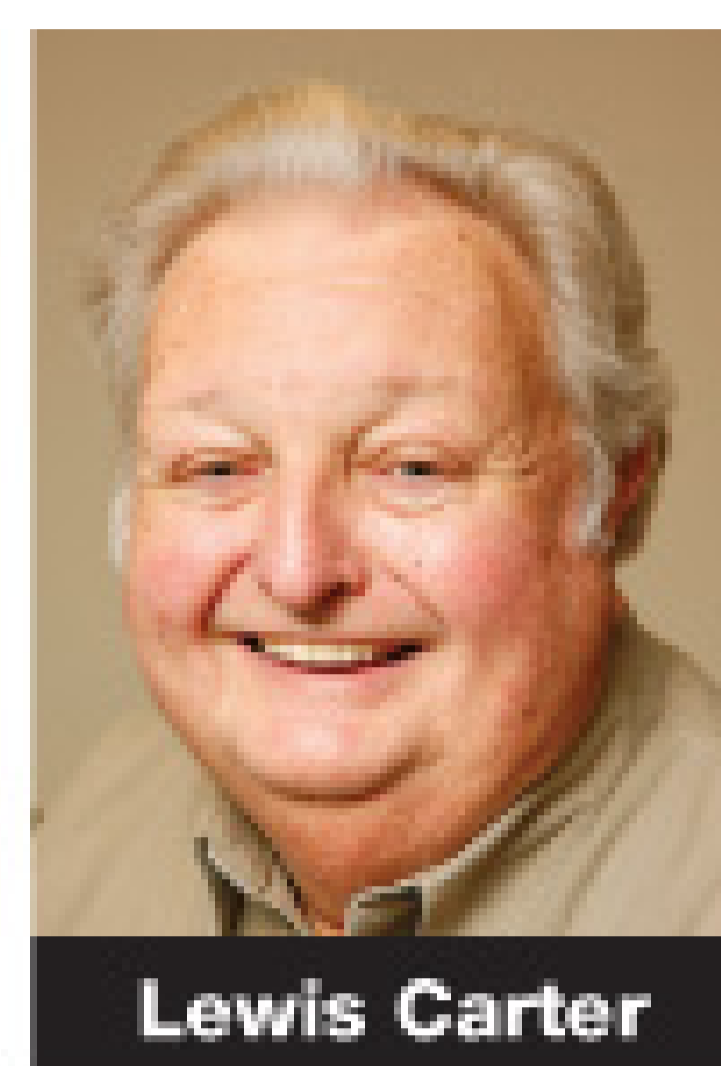

Name:
Lewis Carter
Company:
King Can
Location:
Conyers, Ga.
Years in
Business: **8**

Lewis Carter

"We all knew a group like this was needed," says Lewis Carter. "We just didn't know who would step forward, or whether there'd be good chemistry among the people involved. But I'm very pleased."

Carter is convinced the group's value will grow dramatically in the future.

"This isn't just about getting through some economic trouble," he observes. "This group will be much more beneficial in two years than it is now. I think we'll be invited to air our views on legislation and regulations affecting our industry, which probably wouldn't happen without this group. Even this early, there's a little bit of clout here."

Carter echoed other members' concerns about industry newcomers diluting professional standards.

"If a job with a contractor lasts a year, we want to be able to assure the contractor that we'll still be around doing business by then, as opposed to someone who just drops a hose in a tank and thinks that's all there is to it," he emphasizes. ■



Simple Solutions

D I S T R I B U T I N G L L C

Wolverine Brand Vent Filters Stop the Stink Guaranteed!

UPC Certified
IAPMO Lab Tested
Model #WLW-4

Odor Adsorption
Filters For:
Plumbing and Septic
Vents, Lift Stations,
Sewer Line Vents,
Manholes and
Industrial Applications



1/2, 3/4 & 1" models shown



www.IndustrialOdorControl.com www.StopSepticOdor.com

Offering a Complete Line of Portable Toilet & Septic Needs

*Introducing our two newest
All-Natural Products!*

Nano Eliminator Deodorant and Graffiti Remover

**Non-Toxic
Environmentally Friendly**



Del Vel Chem

C O M P A N Y

Servicing the Industry with Pride Since 1994

250 Old Marlton Pike • Medford, New Jersey 08055
609-714-2424 • Fax: 609-714-3030 • 800-699-9903



Tanks designed
and made for years of
dependable service.



Amthor is Value

Looking for a new tank? Think Amthor.

At Amthor, we deserve our reputation for quality, innovation and expertise.

Our products meet the demands of today's consumer AND exceed industry expectations. With a nationwide distribution network, delivery is simplified. Plus, we add special features and benefits you won't find elsewhere. And, you'll enjoy exceptional customer service.

Visit us online for specific product information.



AMTHOR
International
www.AmthorInternational.com

For your nearest distributor contact: Hank Vanderveen

VA Office: 434.656.6233 • Tel/Fax: 252.293.1284 • Cell: 845.494.0104



Aqua-Zyme Disposal Systems

"From the Grease Trap to the Garden"
– Dewatering & Composting –

#1 Box on the market!

The ADS Dewatering System

is built by a pumping company for pumpers. You are welcome to come and watch the 30 yard box dewater 20,000 gallons of grease trap waste and/or septic tank waste in only 2 hours!

By using the ADS dewatering system along with our Compost Facility, we have turned our disposal costs into a profitable venture!

Call 979-245-5656 for Info!
\$ Financing Available \$

P.O. Box 489, Van Vleck, TX 77482 • www.aqua-zyme.com
1-979-245-5656 • zymme@aqua-zyme.com • U.S. Patent # 6,364,122

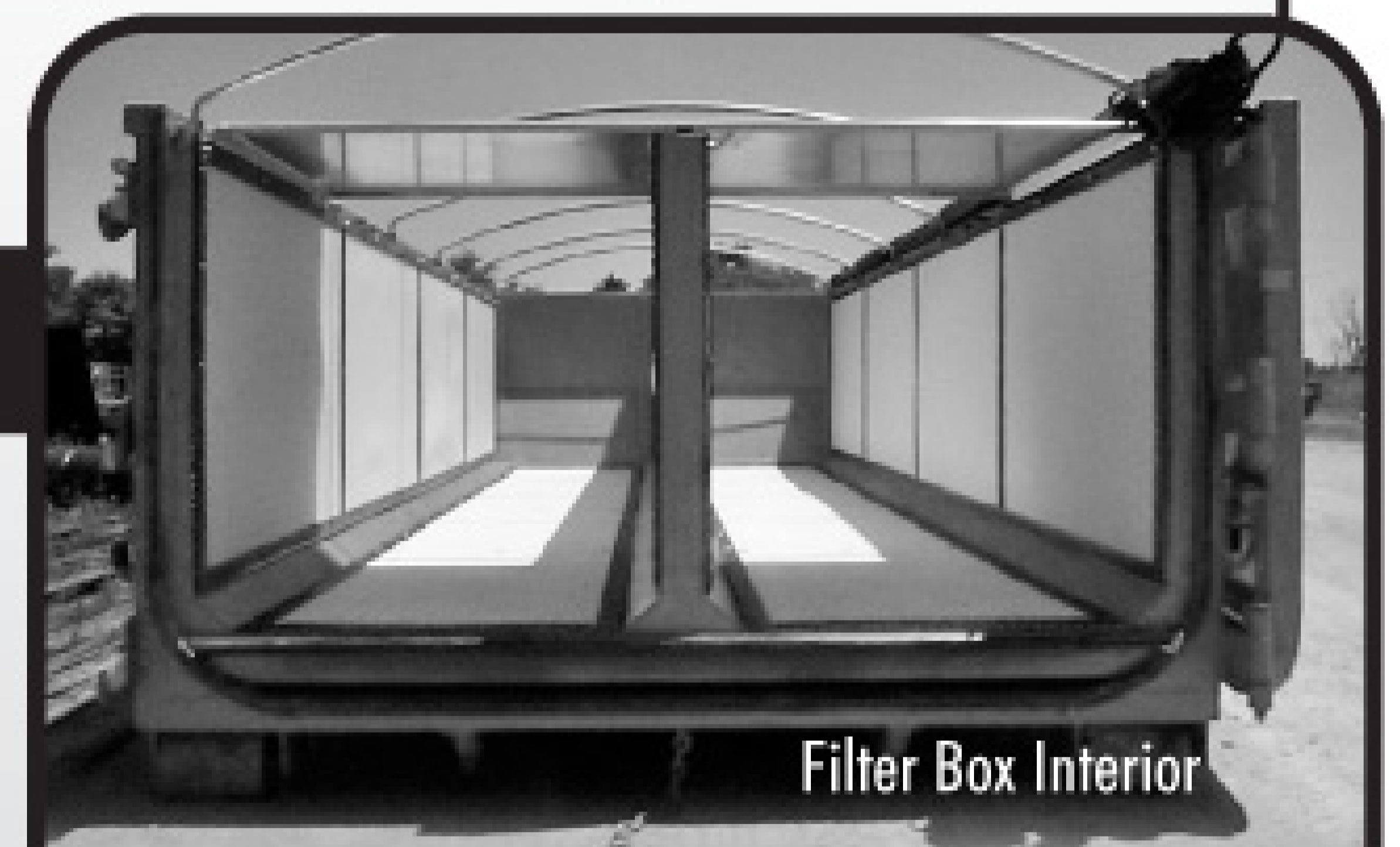

Filter Box Interior



Draining Down

Experience the raw power of...

SURCO®

BLUE • MUSCLE™

THE MOST POWERFUL PORTABLE TOILET DEODORANT IN THE INDUSTRY

Stock up and Order Today!

1-800-556-0111

or on the web at:

www.surcopt.com



SURCO®

— Since 1946 —

292 Alpha Drive • Pittsburgh PA 15238

1-800-556-0111 412-252-7000

www.surcopt.com



©2008 SP



Sludge Mate
& Poly-Mate

The Flo Trend® Sludge Mate® and Poly-Mate® form an economical and simple to use sludge dewatering system. The Poly-Mate® conditions sludge through the addition of polymer prior to the dewatering process which occurs in the Sludge Mate®. These units are designed to dewater sludge from a multitude of waste stream sources including: water and wastewater treatment plants, septic tanks, car washes, industrial sumps and lagoons, grease traps, rendering plants, and food processing plants. The Sludge Mate® and Poly-Mate® are available in a variety of sizes and configurations, and are built to custom specifications.



DEWATERING MADE SIMPLE.

Flo Trend Systems Tel - 713-699-0152
 707 Lehman St. 800-762-9893
 Houston, TX 77018 Fax - 713-699-8054
 sales@fлотrend.com



SIDE DUMP

Call 800-779-8099
 www.sidedump.com

30902 C38
 Le Mars, Iowa 51031

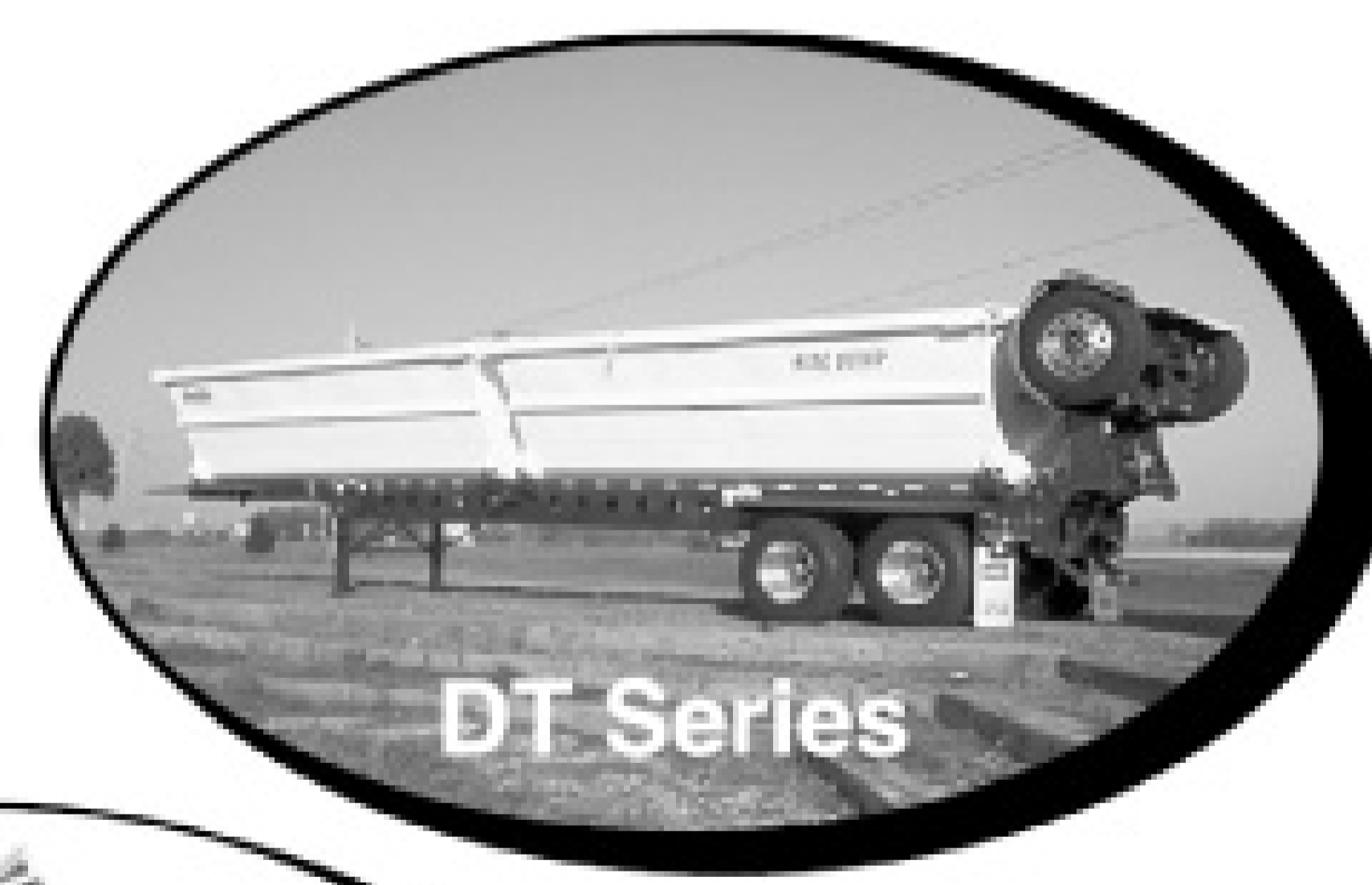

*Manure, Slurry, Sludge, Green Waste, Food Residuals, Compost, SmithCo Hauls it All.
 Stock Pile, Spread, Stability, Selection, Service...SmithCo*

1-YEAR, 100,000 MILE ENGINE WARRANTY NATIONWIDE • COMPARE OUR TRUCKS AND PRICES TO ANYONE



2005 MACK CX 613 VISION
3600 gal US Tanks, Water Cooled Pump 420 CFM, Double Frame



2000 FREIGHTLINER
3600 gal US Tanks, Low Miles 249,937, Ready For Delivery



2001 MACK CH 613
3600 gal US Tanks, Jurup LC 420 Water Cooled Pump, Ready To Work



2000 FREIGHTLINER FL 70
2200 gal US Tanks, Water Cooled Pump, Low Miles, \$45,500



2005 MACK CX 613 VISION
4000 gal US Tanks, Double Frame, 3 In Production



MACK CH 613
3600 gal US Tanks, 420 CFM Water Cooled Jurup



2000 STERLINGS
4000 gal US Tanks, Double Frame, Low Miles, Two In Production, Pick Your Colors Now

IN PRODUCTION
2003 MACK CX 613 VISION
4500 GAL
2004 MACK CX 613 VISION
4000 GAL
2002 MACK CX 613 VISION
4500 GAL, Automatic



2005 MACK CX 613 VISION
4000 TO 4500 gal

SOLD



THANKS TO ULTRA ENVIRONMENTAL SERVICES

**Jetters,
Digital Level
Indicators &
Heated Valves,
No Problem**



THANKS TO THOMAS TRUCKING



THANKS TO ATLANTIC UTILITY



THANKS TO ACE ENGINEERING, INC

Please Call
For More Info

ISRAEL VERA:
305-525-6406

New Salesman

GEORGE GONZALEZ:
954-558-0816

OUR 28TH YEAR

NATIONAL TRUCK CENTER

9750 N.W. 27th Ave. | Miami, FL 33147

Phone: 305.691.8407 | Fax: 305.691.8416

www.nationaltruckcenter.com

★ **WE EXPORT OR DELIVER** ★

U.S. Tanks
THE TOP DOG OF VAGUUM TANKS



CIRCLE D TRUCK SALES

www.circledtruck.com



NEW TANK

(2) 1998 MACK RB688S, E-7 Mack 350 HP, 9 Speed, Engine Brake, Camelback Suspension, 4.64 Ratio, 190" WB, 24.5 Tires, Aluminum / Steel Wheels, Tandem Axle, 12,000# FA, 38,000# RA, HD frame, AM/FM Stereo, P/S, A/C, New Chrome Bumper, (2) 80 Gallon Aluminum Fuel Tanks, Detailed And Serviced. New White Paint. "NEW" 2007 Bulldog Vacuum Tanks, 3,360 Gallons (80bbl), 1/4" Head & Shell Thickness, Primary & Secondary Shutoff, (2) Top Man Ways, (1) Rear Clean Out, (2) Internal Baffles, Sump With (2) 4" Rear Outlets With Wafer Style Butterfly Valves, Front Sight Glass, Vacuum & Pressure Relief Valves, Full Length Hose Trays, Rear Bumper, Jupop R260 Vacuum / Pressure Pump With Pump Stand And Right Angle Drive. Stk. #1487 **\$74,500 each**



VERY NICE!

2001 MACK CX613 VISION, E7-427 Mack, 10 Speed Autoshift, Engine Brake, Air Ride Suspension, 3.70 Ratio, 220" WB, 22.5LP Tires, All Steel Wheels, Tandem Axle, 500-600K Miles, Tilt, Cruise, AM/FM Stereo, Fleet Maintained, (2) 145 gal Aluminum Fuel Tanks, "NEW" 2007 Bulldog Full Tilt Vacuum Tank Hydraulic driven, Controls on driver side, 3,360 Gallons (80bbl), 1/4" Head & Shell Thickness, Primary & Secondary Shutoff, (2) Top Man Ways, (1) Rear oversized Clean Out air operated, (2) Internal Baffles, Sump With (2) 4" Rear Outlets With Wafer Style Butterfly Valves, Front Sight Glass, Vacuum & Pressure Relief Valves, Full Length Hose Trays, Rear Bumper, Jupop R260 Vacuum / Pressure Pump Hydraulic driven fan cooled. Stk #1790 **\$89,500**



VERY NICE!

2002 MACK CX613 VISION, AC-460 Mack, 10 Speed, Engine Brake, 40,000lb RA, 12,000lb FA, Mack Air ride Suspension, 3.90 Ratio, 11R22.5 Tires, Aluminum front Wheels, Chrome exhaust, Tilt, Cruise, AM/FM Stereo, AC, PS, Heated mirrors, Visor, Fleet Maintained, (2) 90gal. Aluminum Fuel Tanks, Super Nice!!! "NEW" Presvac DOT-MC MC 412, 3150 Gallon, Tilt With Full Open Rear Head, 4" Load Line With Riser, 6" Discharge, Catwalk With Handrails, Fruitland RCF 500 Vacuum Pump. **128,000**



4 IN STOCK

2005 MACK VISION CX613 "NEW" Presvac DOT-MC MC 412, 3150 Gallon, Tilt With Full Open Rear Head, 4" Load Line With Riser, 6" Discharge, Catwalk With Handrails, Fruitland RCF 500 Vacuum Pump. Tilt, Cruise, AM/FM, Fleet Maintained, (2) Alum Fuel Tanks **\$135,000**

Available Soon: 1992 Volvo w/Vactor unit, good spec's, being refurbished - Call for price!

MORE TRUCKS AND TRAILERS AVAILABLE, IF WE DON'T HAVE IT WE'LL FIND IT!

Lee Dill, Richard Roberts, John Trammell, Gary Chandler
CIRCLE D. TRUCK SALES

4502 E. OVERLAND TRAIL • ABILENE, TX • 79601
325-677-0474 • FAX: 325-673-7207

888-433-0474



READY TO HAUL

2008 TIGER 1308BL VACUUM TRAILER, non-code, 4 Spring Suspension, Steel Composition, 24.5 Tires, All Steel Wheels, Tandem Axle, Steel Composition, 5460 Gallons, 1 Compartments, Full length walkway with Tool box, (2) 4" butterfly valves, scrubbers, Full length hose trays. Ready to haul!!! **\$37,950**

MEGA Holding Tank

1250 Gallon Size



Options

Black Color • Level Alarm • Custom Fittings

LOW PROFILE Portable Holding Tank

100 • 210 • 300 Gallon Sizes

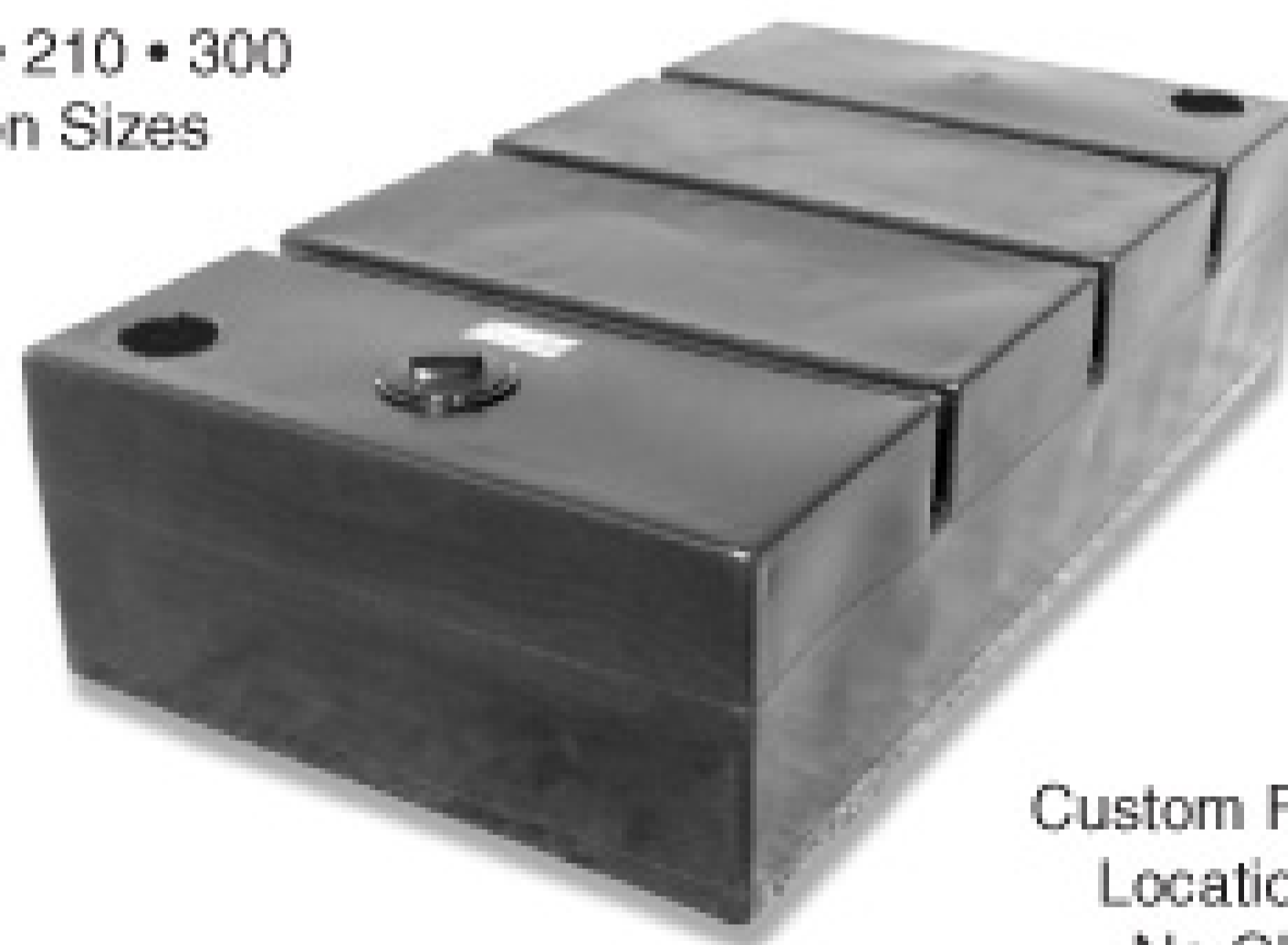

Custom Fitting Locations at No Charge

On-Site Water System

OSW PLUS —

- Tough 65 gal. Tank
- Removable cover for easy cleaning
- 115V On-Demand Pump 3.5 gpm 45 psi
- Low water shut-off
- GFCI Protected
- Filter
- Ships UPS



Easy View Natural

Office Grey

OSW DELUXE —

- Add external fill connection w/float valve

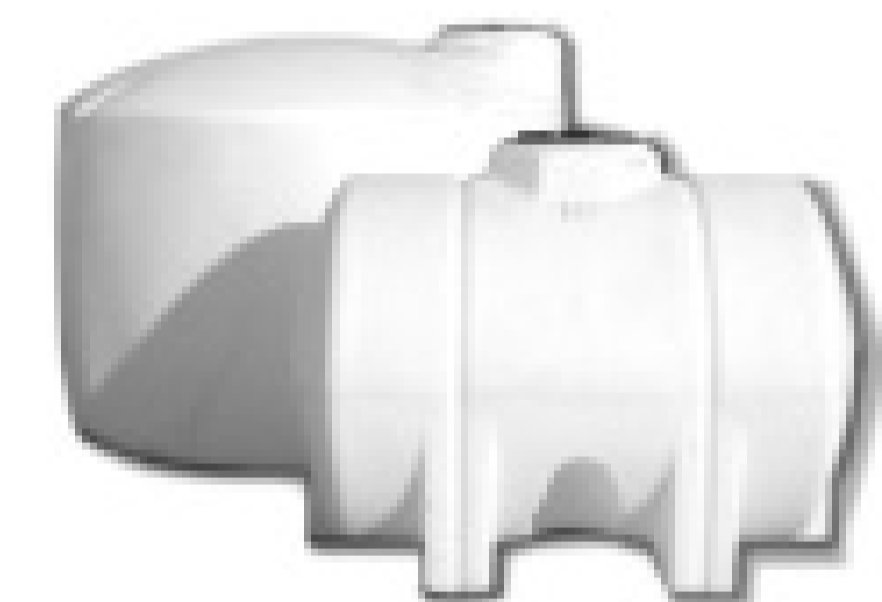

Bulk Storage and Transport Tanks



Septic and Cistern Tanks



Ball Valves and Cam Lock Couplers

NORWESCO

Distributor Since 1987

Nationwide Shipping Points

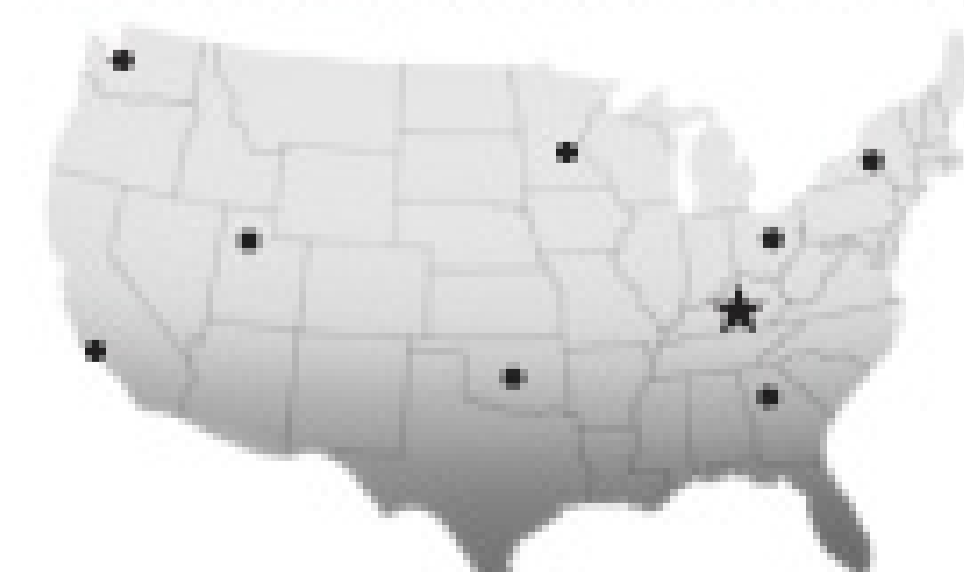

KentuckyTank
Plastic Tanks and Accessories

1-888-459-8265

www.kentuckytank.com

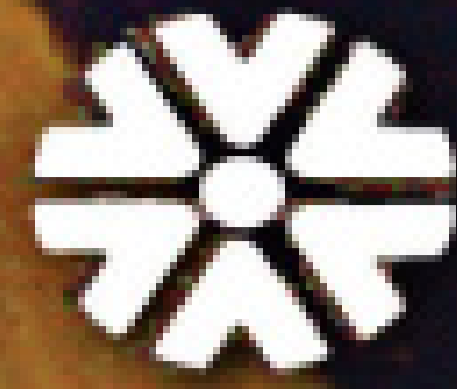

CENTER CAPITAL CORPORATION®

A Webster Bank Company*

Financing geared toward your business success.

THE INTELLIGENT CHOICE

FOR INNOVATIVE FINANCING SOLUTIONS

Environmental Equipment Financing Division

Financing Geared To Your Business Success!

The Intelligent Choice For Innovative Financing Solutions

Center Capital's Environmental Equipment Financing Division offers equipment leasing and financing services tailored to the unique requirements of the waste management and environmental industries. Unlike traditional lenders, our sales team has expertise in both financing and waste management. We understand the kind of payment plans that make sense for your industry. We understand the equipment. We understand the day-to-day business issues you face.

When you work with Center Capital, you're partnering with professionals who understand your business and what it takes to help it grow.

We Cover 50 States!

PAYMENT PROGRAMS

STRUCTURED TO FIT YOUR NEEDS

VENDOR VALUE-ADDED

PROGRAMS

APPLICATION PROCESS

SIMPLIFIED

MORE INFORMATION

CONTACT

Robert A. Marino
Sr. Vice President



Thank you for visiting us in Louisville

Phone: 800-344-2224 • Fax: 215-542-1307
Website: www.centercapitalcorp.com

*Center Capital Corporation is a Subsidiary of Webster Bank, N.A., Member FDIC

chempace[®]

corporation

www.chempace.com

Serving the Industry for Over 40 Years!

One-Stop-Solutions For PORTABLE SANITATION & SEPTIC & GREASE HAULERS

**BUYING DIRECT
ALWAYS EQUALS
COST SAVINGS**



Big Shot[®] Con2 & Con2 Plus

- Super Strength Concentrate
- Non-Formaldehyde
- Ideal for Summer Use

**NEW
FEATURES
ON 3 GREAT
PRODUCTS!**

**NEW
FORMULA!**

**ENHANCED
FRAGRANCE!**

**STRONGER
DYE**

Ultra PowrPak XL

Convenient Carry Pail
Effervescence



**SEPTIC TANK
ADDITIVES \$6** (Per Pkg)



**NEW
PACKAGING
OPTION**

**LONG
LASTING
PINK CUBE
\$160** (Per 4x5 lbs.)

*Designed to last in
hard to service
liftstations/grease traps*



SEWER FOAM \$59.75 (Per Pail)

*Reduce solids and hydrogen sulfide odors -
Economical approach to sewer maintenance.*



**BUY DIRECT CALL CHEMPACE
1-800-423-5350**

**Clearly,
A Good Idea!**



NO CONCEPTS

Solar Powered, Self-Contained,
Special Event Restrooms

www.nuconcepts.com

800-334-1065

CUSTOM SIGNS AND DECALS

United
SITE SERVICES
877-340-0004
800-638-1233

(800) 448-4889
A-Throne
LIVE IT UP!

Another...
**ANDY GUMP
FENCE**
1-888-263-9486

Diamond
environmental services
1-888-744-7191

**TROJAN
PORTABLE
SERVICES**
1-800-427-2673

HAULAWAY
STORAGE CONTAINERS
800-222-3337
haulaway.com

All Of Our Custom Manufactured Products
Are Quality Engineered For Long Term
Outdoor Durability.

- Very Competitive Pricing
- Knowledgeable, Helpful And Courteous
Customer Service Staff.
- Dependable Delivery.
- Digital Print And Vinyl Cut Lettering
- Generic Signs And Decals

And Much More!

**DURABLE, AFFORDABLE AND BUILT TO LAST
SINCE 1949**

J.C. Gury Company Inc.

530 East Jamie Ave, La Habra, CA 90631 Call (800) 903-3385 or (800) 556-5576
www.jcgury.com

'08 International / 3600 Gallon Aluminum



ALUMATANK

Masport HXL 400 system
 water cooled 400 CFM
 Hot shift PTO
 20" top manway
 20" rear cleanout
 rear sump
 with 6" discharge
 and 6" flange
 Large tool box

\$114,200

Lease from **\$1030.** mo.



NOW IN STOCK!

New from **progress tank** SLIDE-IN VAC UNITS



300 Waste / 135 Fresh
 Masport or Conde pump
 Honda electric start
 12 volt water pump

Totally self contained!

\$8,500 M.S.R.P.
 Unit # 4638



1500 Gallon

Masport HXL4, Burks DC10, P.T.O.
 2008 Sterling Bullet - 20,500 GVW
 Cummins 305 HP, / 6 speed trans.

\$66,900 Unit #1420

Monthly lease from **\$1,338**



1-800-392-3513

www.excel-equipment.com

Tel: 317-882-1300 Fax: 317-889-0052
 585 Sayre Court, Greenwood, IN 46143



Unit #1316

2000 Gallon "Combo" Restroom/Septic

500 Water/1500 Septic

Rear manway,

Walkway to manway passenger side

Masport HXL15 - 350 CFM

2008 International 4400 26,000 G.V.W.

Auto trans / hydraulic brakes

\$83,040 Monthly lease from **\$1,660**

The Solution For All Of Your Aluminum Vacuum Tank Needs



**5 YEAR
WARRANTY
ON NEW TANKS**



IN STOCK

7000 Gallon aluminum trailer, full length fender/hose trays, 60,000# Watson Chalin air ride suspension, polished aluminum wheels
\$59,000 + FET

IN STOCK

3,800 Gallon aluminum tank on 2000 Freightliner chassis, with Jurop PNR 142 vacuum pump, \$64,900 tax included

Longhorn Tank Co.

P.O. Box 1147

Gravette, AR 72736

800-422-9840

479-787-7910



We Have Financing Available!



2007 Sterling AUTO TRANS 4000 Gallon Steel tank, Jurop pump, Cat 330 HP, Allison auto 18K ft, 40K rear exhaust brake, ALUMINUM TRAYS.

\$102,000 Plus FET

Now In STOCK!

On-The-Lot Selection Call For Prices & Pre -Approval!



2007 Sterling AUTO TRANS 2500/300 Gallon Aluminum, PM80 pump Cat 275 HP, Allison auto, Exhaust brake, Traction Control.

\$92,000



2007 Sterling 2500 Gallon Steel, Jurop pump, Mercedes 260 HP, 10 spd, engine brake, Traction control ALUMINUM HOSE TRAYS.

\$77,500 Plus FET

Call Us Today Toll-Free:

888-201-9166

Septic - Portable Toilet - Hoisted Vacuum - Slide-Ins
New! Units Available / Trade-ins Accepted! / Financing & Lease Plans



Top Line

Scentbox

LEONES



# of toilets	8	104
DISCOUNT PRICE	\$399.00	\$349.00
FREE DELIVERY <small>Continental US only.</small>		

# of toilets	8	104
DISCOUNT PRICE	\$439.00	\$389.00
FREE DELIVERY <small>Continental US only.</small>		

International Patent Pending
PCT/IT2007/000700

Top Line

The new portable toilet **TOP LINE**: more durable, easier to handle and simpler to clean. With **TOP LINE** you get a high quality toilet at an unbeatable price and free delivery.

Color available:

Light blue, Dark blue, Light green, Bright red, Bright orange, Bright yellow, Caramel, Ash gray.

Walls do not have any graphics and Armal logo.

Scentbox

The first portable toilet with **scented wall panels**. Sturdy and easy to clean **Scentbox** is available in 5 fragrances and 5 new colors.

Fragrances available:

Strawberry Field, Apple Blossom, Pinewood Trail, Rose Sensation, Vanilla Balm.

Armal
www.armal.biz

Armal Inc. - Griffin USA - Phone 770 491 6410 - Fax 770 491 9458 - Toll Free 866 873 7796 - armal-inc@armal.biz

Choose Drainfield Carefully

Get under the topsoil and research the best possible effluent distribution plan before you start digging

By Roger E. Machmeier, Ph.D.

Q Of course, the flow numbers given in your article ("Depth Charge," October 2007) are for trenches ... reflecting a common attitude (bias) found in many areas that all normal systems are trenches. A drainfield is, in this view, a network of trenches. But, in New Hampshire and Maine, with thin, rocky soils often with shallow water tables, trench systems are rare. Many contractors have never installed one. We have installed leach beds as a mainstay system since the beginning of design rule, with other types as a less common alternative, until the advent of the fabric-based systems in the '90s. The proportion of bottom to sidewall is very different for beds versus trenches. Yet, as the bed ages, it becomes, in essence, a "fat trench."

I see your numbers reflect an important factor: regarding the soil unit as a whole, rather than as, say, bottom area only. This is from the notes on reducing length based on depth of stone (gravel or rock).

A I appreciate you having taken time to write to me with your opinion of trench systems and describing the leach bed systems being installed in thin, rocky soils with shallow water tables in your area. Frankly, this doesn't seem like a good treatment practice to me and I'll explain why.

Any soil absorption system

must have a large enough area of a suitable soil exposed for adequate treatment of the average daily sewage flow. Some of the key words here are "suitable soil" and "adequate treatment." Suitable soils have percolation rates of from 1 to 60 minutes per inch and no seasonally saturated conditions closer than three feet to the bottom of the absorption area.

DO THE MATH

The soil absorption area can be available in leach beds, but more absorption area is available in drainfield trenches. It is a common practice to size the absorption area based on the bottom area. For example, if 600 square feet of absorption area is called for in the design, this could be a leach bed 10-feet-wide by 60-feet-long. It could be 200 lineal feet of 3-foot-wide trench with a minimum of six inches of rock below the 4-inch pipe and two inches above the pipe for a total rock depth of 12 inches. It could also be 300 lineal feet of 2-foot-wide trench.

The total amount of soil exposed to sewage tank effluent is quite different in each of these three systems when the amount of sidewall area is added. The following table shows the amount of total absorption area of the three examples above:

Square feet of soil exposed to effluent in various systems			
	10- x 60-foot leach bed	200 feet of 3-foot wide trench	300 feet of 2-foot-wide trench
Bottom Area	600	600	600
Sidewall Area	140	400	600
Total Area	740	1,000	1,200

Heavy construction equipment with wheels must not be used in mound construction. Track-type equipment with a low ground pressure must be used. There is a definite art and science to properly constructing a sewage treatment mound.

It is for this reason that the bottom area of a leach bed should be sized 50 percent greater than a trench system. If 600 square feet is the required bottom area, a leach bed should be sized as 600 plus 50 percent of 600 for a total of 900 square feet. Then the soil exposed in a leach bed will begin to approach the amount of soil exposed in a trench system.

You referred to my column on increasing the depth of rock. Trench bottom areas can be reduced when there is more than six inches of rock under the distribution pipe. The reason for the reduction in bottom area is the increased sidewall area. The reductions are as follows:

- For 12 inches of rock below distribution pipe, reduce bottom area by 20 percent
- For 18 inches of rock, reduce bottom area by 34 percent
- For 24 inches of rock, reduce bottom area by 40 percent

The bottom area of a leach bed cannot be reduced with additional rock depth, simply

because there is very little sidewall in a leach bed.

You state that "as the bed ages, it becomes, in essence, a 'fat trench.'" As the biomat develops in the bottom of a leach bed, the effluent level rises. But I would not refer to it as a "trench." As one can see from the table, there is very little sidewall in the leach bed as compared to either the 3-foot-wide or the 2-foot-wide trenches.

I do not understand how leach beds can be effective to properly treat sewage tank effluent where the soil is thin and rocky with shallow water tables. One could certainly keep the bottom of a trench as far above the shallow water table as the bottom of a leach bed. If there is any slope on the ground, a leach bed would require some excavation on the upslope side to keep the bottom level. This would not be necessary with shallow trenches.

The soils you describe as not being suitable for trenches do not seem to be suitable for leach beds either. From your description, it seems that sewage treatment mounds would be the most effective sewage treatment system.

I have written about mounds before, so this is just a little refresher course. Installation of a mound uses a 10-foot-wide rock

Readers are welcome to submit questions to the Answer Man. Send your question to COLE Publishing by e-mail to editor@pumper.com, by fax to 715/546-3786; or by mail to P.O. Box 220, Three Lakes, WI 54562. We will pass your question along to Dr. Machmeier.



bed with pressure distribution. There is no excavation of the original soil, which, as you state, is "thin."

The soil should be slightly roughened, but handled with care to preserve the soil structure. A layer of clean sand is placed on the original soil after vegetation and other surface trash is removed. The top surface of the sand layer is level. The sand layer tapers down on each side of the 10-foot-wide rock bed to expose more of the original soil to the effluent.

PERFORATED LATERAL

Heavy construction equipment with wheels must not be used in mound construction. Track-type equipment with a low ground pressure must be used. There is a definite art and science to properly constructing a sewage treatment mound.

The pressure distribution system is perforated plastic pipe, usually 1-1/2 inch in diameter,

placed on 40-inch centers in the 10-foot-wide rock layer. Perforations of 1/4 inch are drilled every 36 inches in the bottom of the perforated laterals. A pumping station is required in addition to the sewage tank. The pump delivers about 25 percent of the average daily sewage flow to the perforated lateral system with each cycle.

My opinion is that leach beds are not the best system to use for proper sewage treatment in the soils you describe. If those leach beds do in fact treat the sewage, then trenches can be used. If leach beds do not treat the sewage because of poor soil conditions, then sewage treatment mounds must be used if proper treatment is the goal, as it should be. ■

Dewatering Equipment



Use The Right Equipment To Get The Best Results.

Liquid Reduction = Reduced Transportation Costs

Dewatering = Reduced Tipping Fees

Non Organic Separation = Facilitate Land Application of Liquids

ACCENT
MANUFACTURING INC.

Designed for Simplicity. Engineered for Durability.

Toll Free: 877.855.4890

info@accentmanufacturing.com • www.accentmanufacturing.com

ENGINE & ACCESSORY, INC.

Toll-Free: 1.800.327.5431

Tel: 305.573.2268

Fx: 305.576.4617

www.eamfg.com



Engine & Accessory is your one stop shop for all of your vacuum truck needs. Delivering the best possible customer experience.

Benefits include:

- *ISP Program - In stock tank and truck program*
- *Direct access to all major chassis manufacturers*
- *State of the art manufacturing facility complete with service shop*
- *Extensive parts inventory and complete product support*
- *Full engineering capabilities using the latest technology*
- *Knowledgeable sales staff*
- *Customizable units with a broad range of options*
- *Nationwide product delivery*
- *Complete package of financing and lease options*



2007 Ford F750 - 2000 gallon tank (1500/500) - Low work station - Masport pump system - Several Available

Several Pre-Emission Units Available

Many 2007 Pre-emission Fords and Isuzus available for Portable Restroom Service Units.



Aluminum vacuum trucks. Sizes range from 2000-5500 gallons with many pumping system options available.

Call Today!



Spec your Industrial Unit. Options for Hoist and Full open rear doors. DOT Code and Non Code.

Call Today!



Steel vacuum trucks. Sizes range from 2000 - 4000 gallons with many pumping system options available.

Call Today!



Comfort Elite Mobile Restroom Trailers



See what over 50 years of trailer manufacturing experience can do for a restroom. See what the other guys will be trying to keep up with next.

Ask Us About Our NEW:

- ◆ GPS Monitoring System
- ◆ Negative Ion Air Purifiers
- ◆ Lead Referral Program
- ◆ Corian Countertops
- ◆ New Platinum Edition
- ◆ ADA Units
- ◆ Arctic/Winter Packages

Effective **Solutions.** Uncompromising **Quality.** www.wellscargocog.com **888.574.4222**

POWER



1-800-758-4788

Vacuum Pumps & Tank Parts at
WHOLESALE PRICES!

Juop

PRODUCTS

INC.



PN84
• 252 cfm @ 18"
• Air Cooled

PN 23, 33, 58, 84, 106
IN STOCK.



LC20
• 425 cfm @ 18"
• Liquid Cooled



R260
• 304 cfm @ 18"
• Ballast Port Cooling

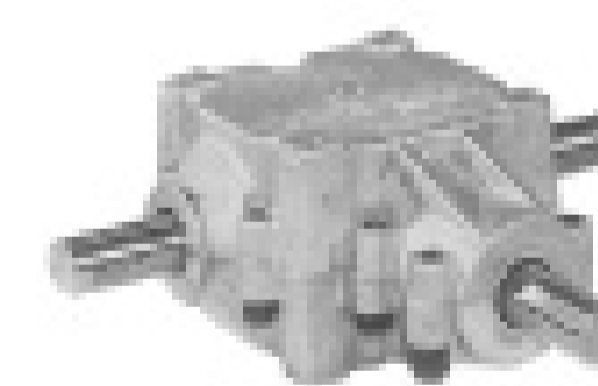

RT Angle Gearbox
1" - \$199
1 1/4" - \$299

Lever Action Gate Valve

Brass
2" - \$10
3" - \$98
4" - \$157
6" - \$288



Piston Action Gate Valve

Brass
4" - \$69
6" - \$183



Secondary

Nylon/Brass
2" - \$160
3" - \$206



Manway Special Gasket in lid

20"
35"

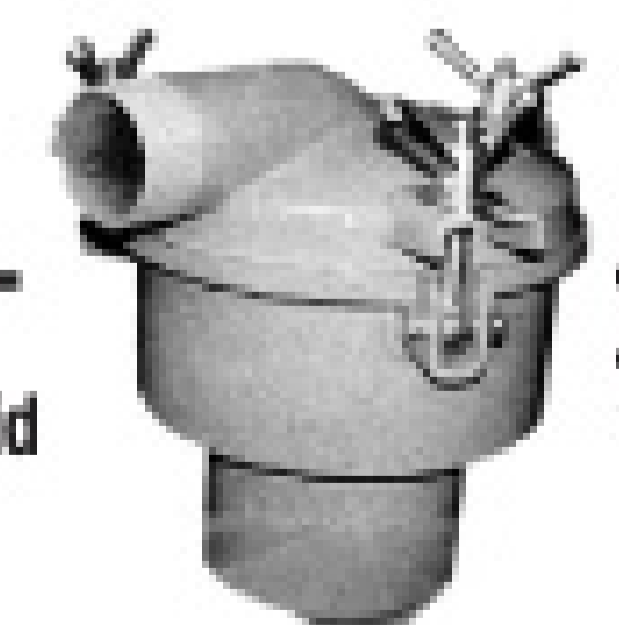
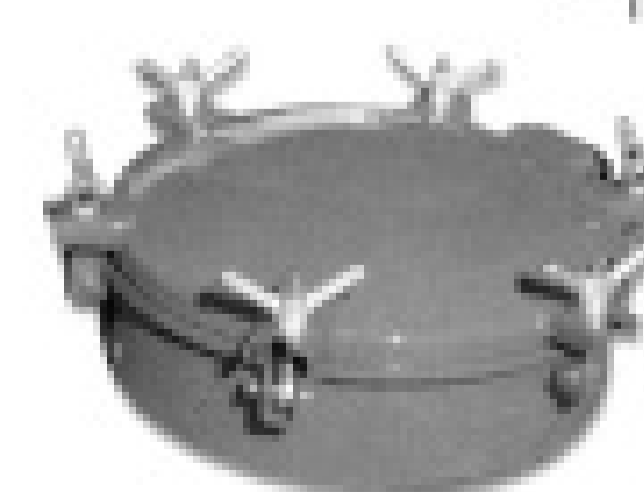

Low Pro Primary

\$295

POWERFLO MODEL:	PF330	PF540
Air capacity displacement	258 cfm	300 cfm
Air capacity displacement @ 15" Hg	248 cfm	290 cfm
Minimum vacuum	95%	95%
Minimum pressure	30 psi	38 psi
RPM	1200	1200
Weight	308 lbs	357 lbs

Performer Series PF540

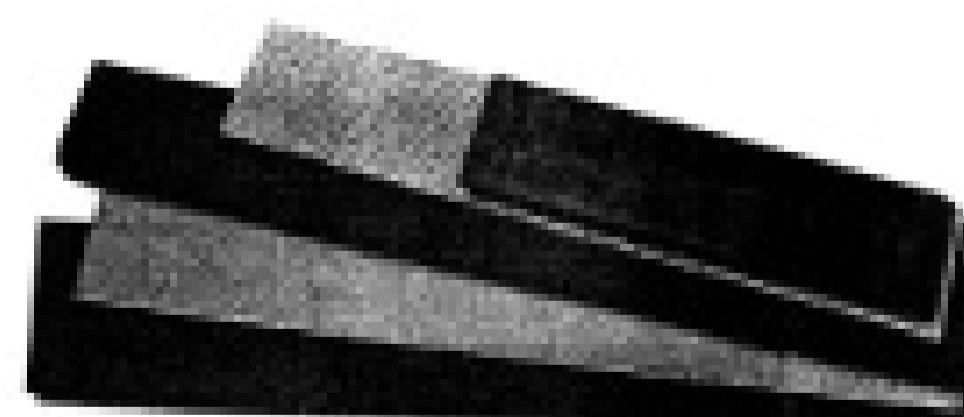

Dura-Comp Pump Vanes

Exclusive manufacturer since 1991. 400 non-asbestos material. Long lasting, self lubricating, satisfaction guaranteed!



DC-10

Heavy-Duty Washdown Pump

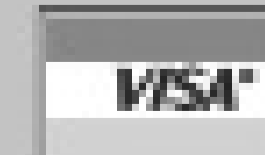

POWERFLO PRODUCTS INC. • 2755 N. Gaviota Ave. • Signal Hill, CA 90806 • Phone: 562-997-0720 • Fax: 562-997-0724

BEST ENTERPRISES, INC

Not Just Another Satisfied Customer - 70 Trucks Purchased

Call-A-Head Corporation is located in Broad Channel New York and has been a customer of Best Enterprises since 2002. Call-A-Head Corp. is one of New York's largest portable toilet companies. They service all five boroughs of New York City, Nassau, Suffolk and Westchester Counties. They sell, rent and service portable toilets of every description. Call-A-Head's service is service people trust. Every Call-A-Head Truck is never over 3 years old. This allows their drivers to have the best equipment and supplies available in the industry. Call-A-Head Corp. has been buying equipment from Best Enterprises for 6 years, and now only has Best Enterprises trucks in their fleet. Call-A-Head

has just purchased their 70th truck from Best Enterprises. The brother duo of Charles & Kenny Howard head up this corporation with style and integrity. Call-A-Head was started by their father in 1976, and has been going strong for 32 years. Charles took over as President and CEO in 1981, with Kenny following as Vice President in 1989. The company runs over 60 trucks in their fleet. A normal day is 52 trucks running with an average of 50 to 70 stops per day for each truck . They plan to have at least 10,000 toilets set out by 2009.

CALL - A - HEAD
Portable Toilets of every description

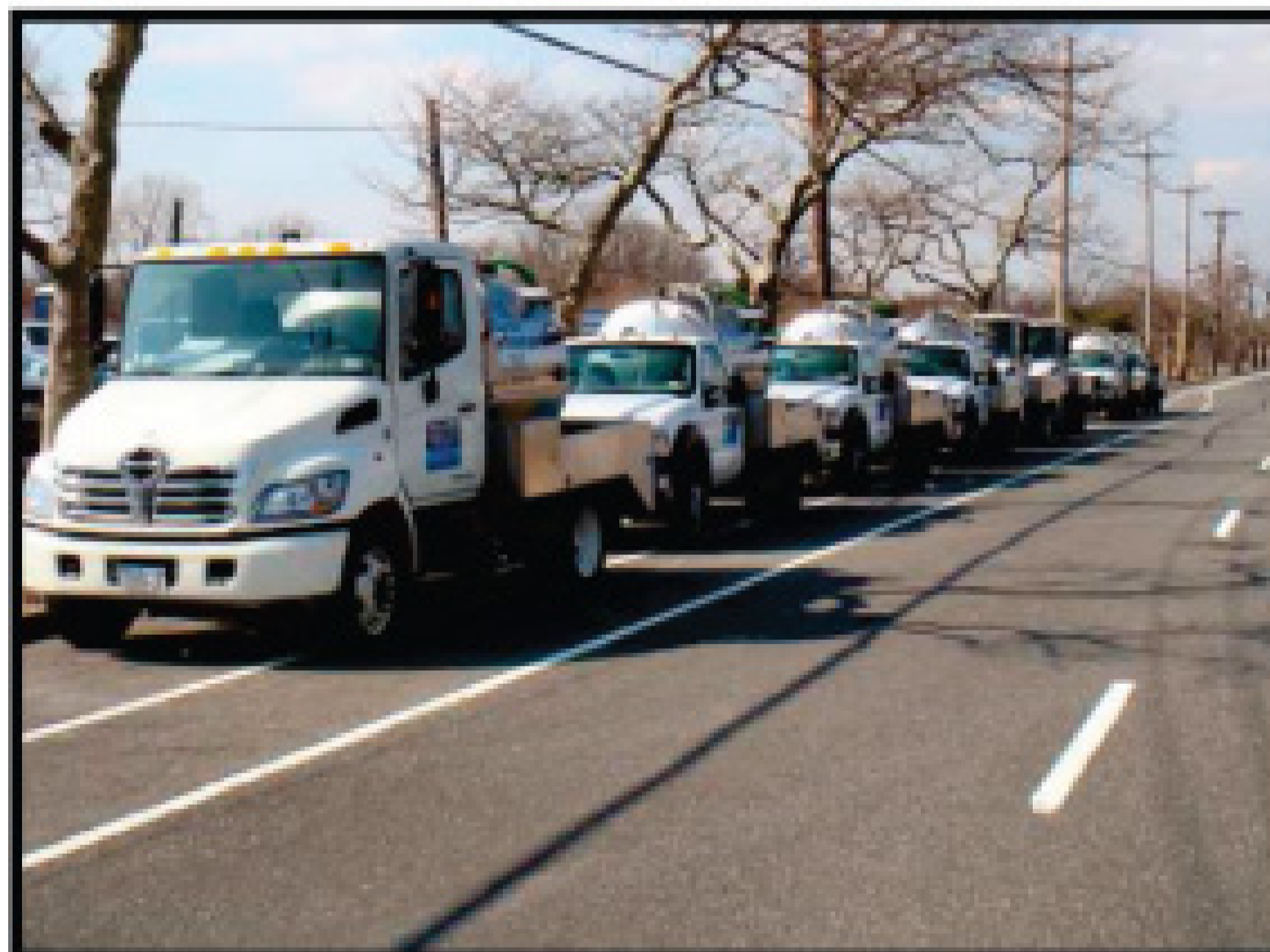

With just a quick phone call you get impeccable service from this dedicated team. They offer on call service, daily and weekly services as well. It is no wonder with the selection of portable equipment they offer that they are one of the first ones called upon to do special events in the New York area. Best Enterprises is proud to be the only Truck and Stainless Steel Tank Supplier that Call-A-Head will use. Kenny Howard had this to say; "Call-A-Head and Best Enterprises has created and designed the most reliable, best looking and easiest to operate portable restroom truck."

We congratulate Call-A-Head on their 70th truck purchased from Best Enterprises, Inc. As it says on their web site, "Our drivers have the **best equipment** and supplies available in the industry" we believe this is true. Check out Call-A-Head's web site at www.callahead.com and you will see why these brothers are the leaders of portable sanitation in the New York area. Thank you Call-A-Head for your continued business.



Best Enterprises, Inc.
3513 W. Mt. Springs Rd

1-800-288-2378
www.bestenterprises.net

Stainless Steel Vacuum Tanks for the Portable Sanitation Industry

No COMPROMISE

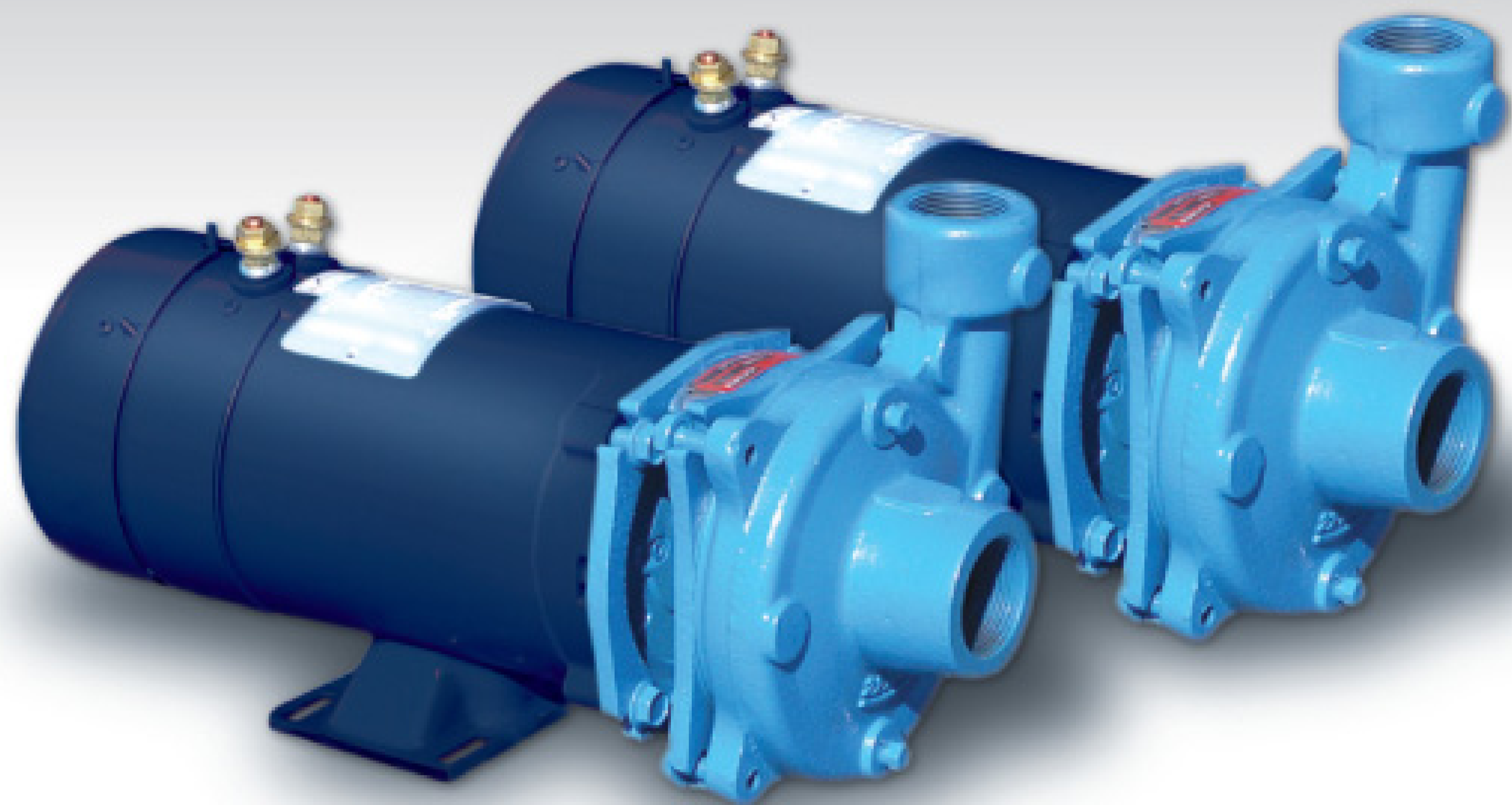

Don't accept a substitute for quality. The Burks DC-10 is still the most popular, high volume washdown pump available.

With flow rates to 20 gpm and pressure to 40 psig, the Burks DC-10 is the pump of choice for filling and washing your portables.

Contact your local tank manufacturer for more info, or call us toll-free at:

800-699-7557

**ARMSTRONG
EQUIPMENT
INC.**

11200 Greenstone Ave. • Santa Fe Springs, CA 90670
562-944-0404 • Fax: 562-944-3636

www.vacpump.com

Lenzyme

Quality Sells ~ Sell the Best



Top-Rated

- ➔ *Premeasured Packets*
- ➔ *FREE Educational Brochure*
- ➔ *FREE Private Labeling*

BEST PACKAGING - BEST PRODUCTS - BEST PRICES



Call Today for Your **FREE** Sample

1-800-223-3083

920-436-8266 • Lenzyme, Inc.

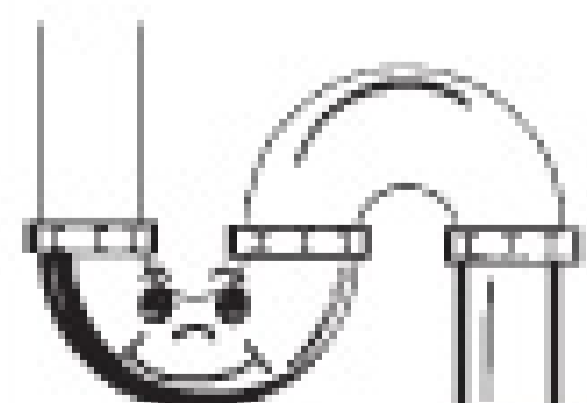

The **5**

Enzyme - Bacteria
Grease and Waste Digestant

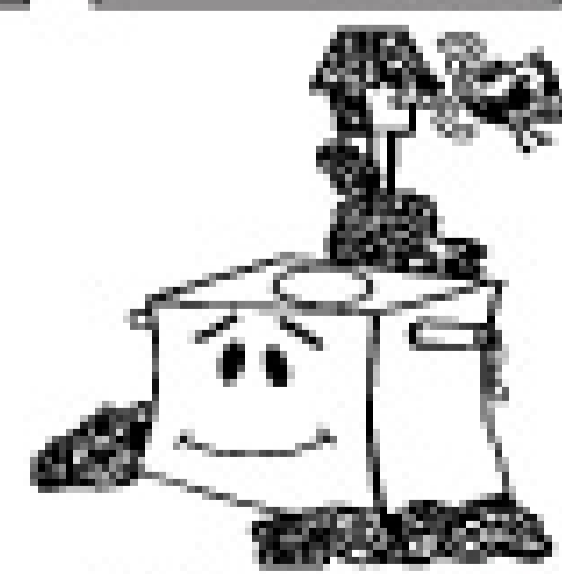
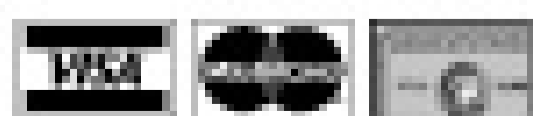

FINANCING

FOR ALL YOUR
NEW & USED EQUIPMENT

**GIVE US A CALL TODAY!
866-769-2345**

**31 YEARS OF EXPERIENCE
WORKING FOR YOU!**



CAPITAL PARTNERS

101 N. Main Ave. Suite 215
Sioux Falls, SD 57104
www.yourcapitalpartner.com
866-769-2345

**YOUR ONE STOP
FINANCING PARTNER**

*Competitive Pricing, Simple Processing,
Honest Answers*



What you **learn** on these pages could be worth **\$1,000s.**
It's all yours for **\$1 a month.**

That's right. Some **25,000** of your industry peers welcome **Pumper** every month for the value it brings to their business. Each issue shows you:

- **New tools** to help you win jobs and earn more profit.
- **Ways to save** on office expenses, supplies, advertising, taxes.
- **Money-saving** deals on equipment.
- And much **more.**

Best of all, you'll learn from **other successful business owners** – how they did it, and how you can, too.

Don't miss an issue –
subscribe today!



Pumper

DEDICATED TO THE LIQUID WASTE INDUSTRY

- 1 Year (12 issues) ... **\$16**
 2 Years (24 issues) ... **\$26**
 3 Years (36 issues) ... **\$36**
 (U.S. rates only. Call for intl. rates)

Start my subscription to Pumper magazine.

Signature (required) _____ Date _____

Attention _____

Company Name _____

Mailing Address _____

City _____ State _____ Zip _____

Phone _____ Fax _____

E-Mail _____

METHOD OF PAYMENT (please check one):

- Check enclosed (payable to COLE Publishing Inc.)
 Charge to VISA ___ MasterCard ___ Discover ___

Card # _____ V-Code _____

Cardholder Name _____ Exp. Date _____

What is your company's primary function? _____

What else does your company do? (circle letters below):

- | | |
|--|--|
| A TV/Video Inspection | M Manufacturer of _____ |
| B Pipeline Rehabilitation/Sewer Repair | N Septic System Design |
| C Drain/Sewer Cleaning (Rooting, Jetting) | P Plumbing/Heating/Cooling |
| D Dealer/Distributor of _____ | Q Excavation/Grading |
| E Grease Pumping/Disposal/Treatment | R Refuse (Solid Waste) Hauler |
| F Septage or Sludge Disposal/Treatment | S Septic Tank Service-Pumping/Maintenance |
| G Government/Municipality/POTW | T Portable Toilet Rentals |
| H Hazardous/Industrial Liquid Waste Hauler | V Industrial Plant Service Vacuum/Cleaning |
| I Septic System Installation/Repair | W High Pressure Waterblasting |
| J Non-Hazardous Liquid Waste Hauler | Y Hydroexcavation |
| K Directional Drilling/Boring | Z Equipment Rental Center |
| L Consulting | Other _____ |

Fax this form (with payment option selected) to 715-546-3786

Mail this form (with payment option selected) to
 COLE Publishing, P.O. Box 220, Three Lakes, WI 54562

Phone 800-257-7222 **Online** at www.pumper.com

7000 Gallon Aluminum



Manufacturing

- *Stainless Steel*
- *Aluminum*
- *Code & Non-Code*

800-589-5254

ACRO Trailer Company

*Vacuum Trailers for the
Liquid Transportation Industry*
Parts • Repair • Complete Pumping Systems

www.acrotrailer.com • 417.862.1758 • fax 417.862.8084 • 2320 North Packer Road • Springfield, Missouri 65803

WANT A TRUCK THAT REALLY SUCKS?



Vacuum Trucks from Rocket Supply

The Amthor Matador Flat Vac

The Amthor Matador Flat Vac offers an exclusive improved tank design available in 5/16" aluminum, 1/4" steel and 1/4" stainless steel with capacities from 500 to 2000 gallons with full internal baffles. This unique body is used to service portable toilets and can carry 8 to 12 at one time, making it a very efficient vehicle. Features a rounded floor that allows for easy product drainage.

The Amthor Matador

The Amthor Matador offers an exclusive improved tank design available in 5/16" aluminum, 1/4" steel and 1/4" stainless steel with capacities from 500 to 7000 gallons. With full internal baffling and a heavier side shell than the competition, it allows for the absence of external rings, which provides a smoother looking tank when adding your brand or logo to it. Dumping options are also available.

For Excellent Price and Fast Delivery!

Rocket Supply

Since 1959

Contact Us for More Details



Roberts, Illinois • 800-252-6871 • www.rocketupply.com



A Subsidiary of The Gorman-Rupp Company™

12 VOLT DC HIGH HEAD WASHDOWN PUMP

- 1 HP Washdown Duty Motor for Severe Operating Conditions
- Investment Cast 316 Stainless Steel, Cast Iron or Cast Bronze Construction
- All Models Equipped With High Efficiency Stainless Steel Impeller
- Discharge Port Rotates in 90° Increments
- Four Front Drain Plugs
- Maximum Flow 56 GPM
- Maximum Head 80 Ft. (35 PSI)
- Maximum Temperature 200° F



The AMT 12 Volt DC Washdown Pumps are designed for pumper, septic service, OEM, and marine applications requiring a DC motor. The motor has a one hour duty rating and is furnished with a grade 303 stainless steel shaft. Washdown Duty Pumps are available in a variety of construction and seal materials to meet your specifications. Pull-from-the-rear design for easy servicing without disturbing piping.

Call us toll free at 888-268-7867 or visit our website www.amtpump.com for more information.

American Machine & Tool
A Subsidiary of The Gorman-Rupp Company
400 Spring Street
Royersford, PA 19468



814.535.6766



www.gapvax.com

NEW TOWN...NEW VENUE...SAME ATTITUDE!

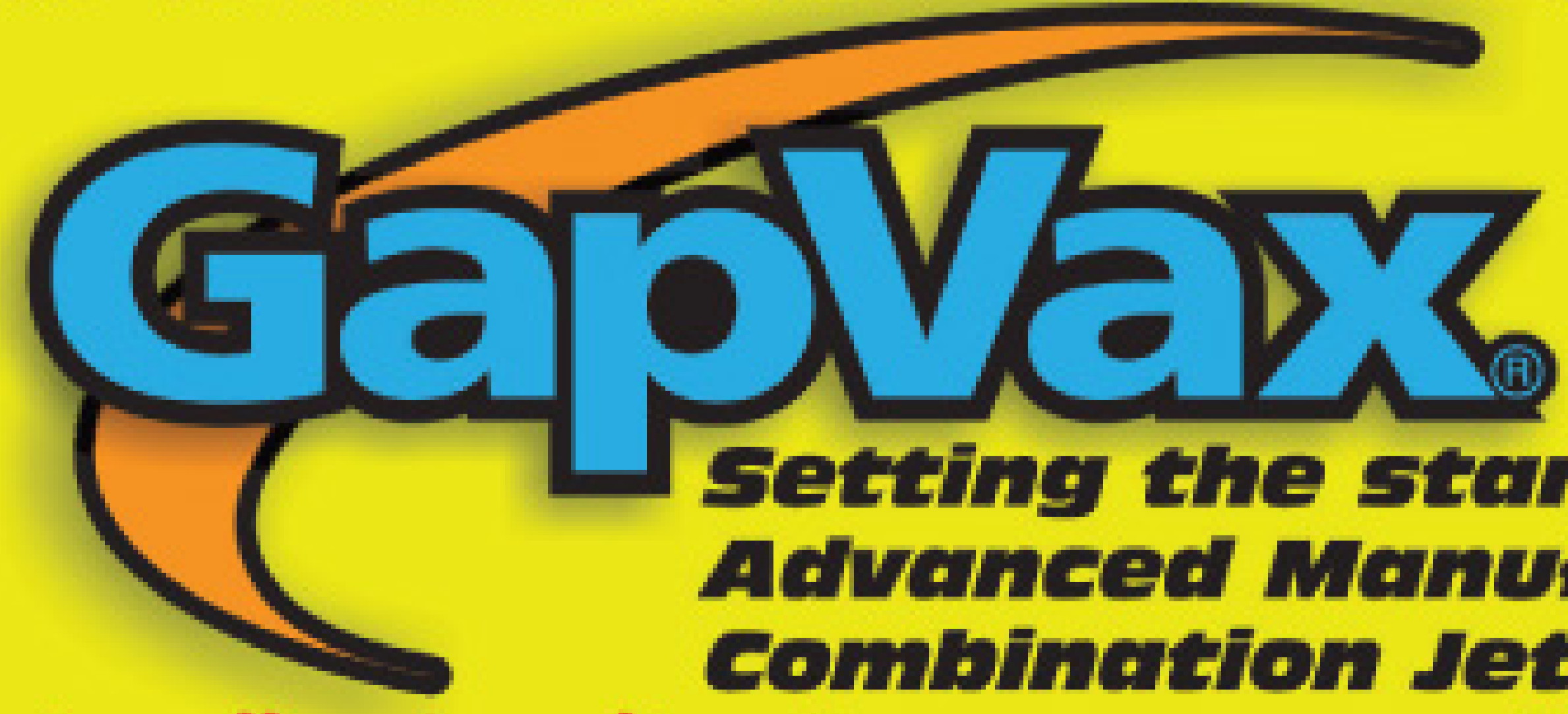

Setting the standard...as The World's Most Advanced Manufacturer of Industrial and Combination JetVac Equipment!

Thank you for attending the show...give us a call...let us know what we can build for you!



MTM Technologies presents the PRO Solutions Toolkit

Improve Your Quality... Lower Your Costs



Portable Restroom
Tracking



Fleet
Management



Service
& Delivery
Confirmation



Performance Reporting
to Maximize Efficiencies

Integrated with
Total Activity Control
CLEAR COMPUTING

www.clearcomputing.com • 888-332-5327

**Call now to reserve
your Pumper Show
reduced pricing.**

For more information
please contact us:

1.888.996.4276

www.microtargetmedia.com

techsales@microtargetmedia.com



TANKS SHIPPED TO YOUR LOCATION

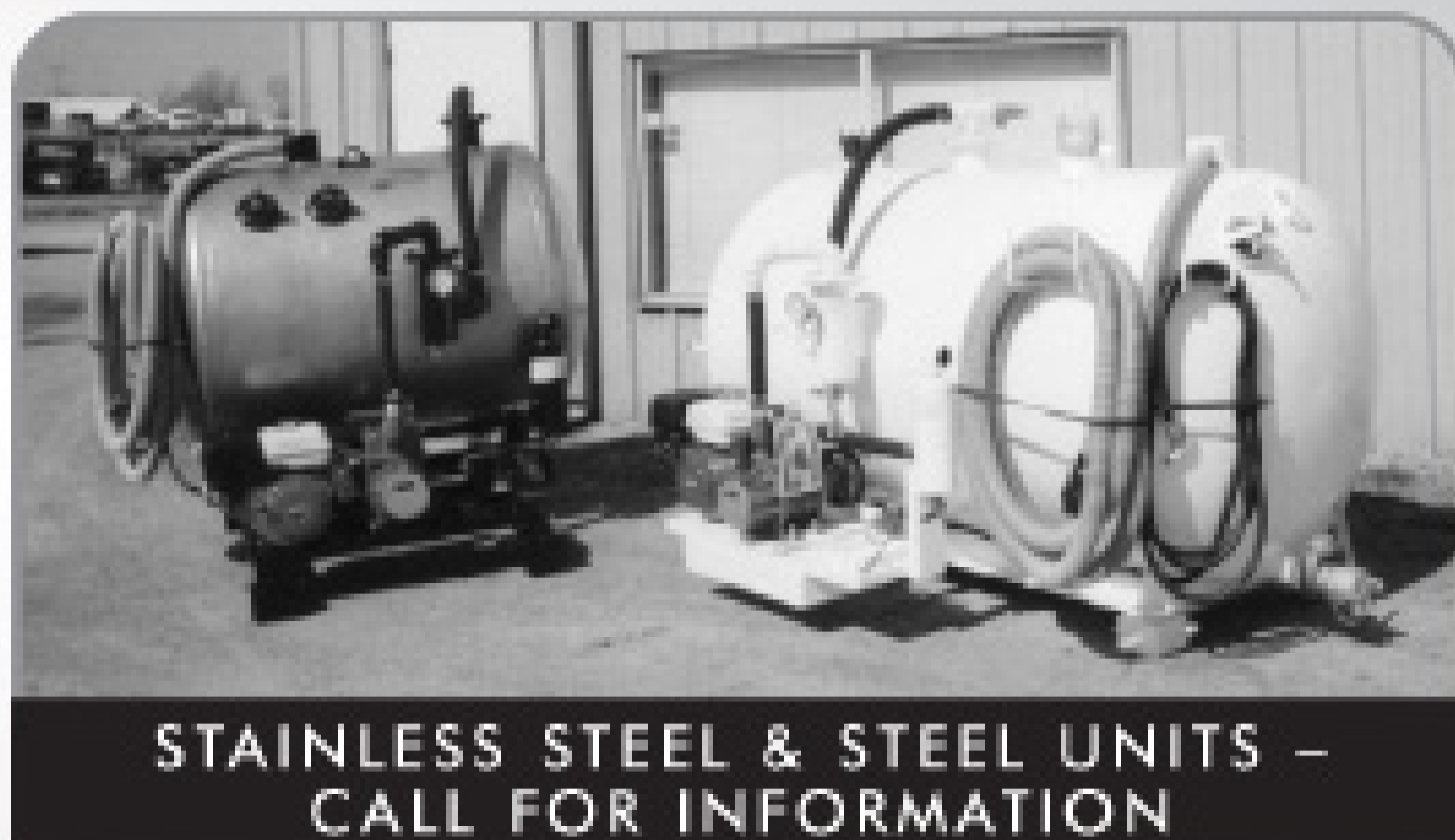

STAINLESS STEEL & STEEL UNITS -
CALL FOR INFORMATION



TANKS MANUFACTURED TO YOUR SPECIFICATIONS

PUMP DISTRIBUTOR

- * BATTIONI
- * JUROP
- * BOWIE
- * MASPORT
- * FRUITLAND
- * MORO

Pump Rebuild Kits In Stock

**CALL TODAY FOR
INFORMATION
OR PRICES ON
TANKS, PUMPS
AND ALL PARTS**

Secondary Shutoffs

Sight Glasses, Valves & Couplings

12" Primary Shutoffs

21" & 36" Manways

BASE TANKS INCLUDE:

1/4" Thick Steel • Pipe Reinforced Baffles • Primary Shutoff
Flanged and Dished Heads • 21" Top and Rear Hatches
Full Length Under Carriage on Bottom of Tank

BASE TANK PRICING

2100 GALLON.....	\$6150	3360 GALLON.....	\$8910
2500 GALLON.....	\$7080	3570 GALLON.....	\$9470
3000 GALLON.....	\$7820	4000 GALLON.....	\$10,520



800.364.7307

2100 EAST BOOTH ST. • SEARCY, AR 72143
Fax: 501.279.0003 • E-mail: sbs@cdlworld.net



IT'S FREE!

Buy a drum or tote of any Green Way Products deodorizer or cleaner and get a Protect Your Investment Kit FREE*.

You have thousands of dollars invested in restrooms, trucks, tanks, hoses, and other equipment. It makes good business sense to protect your investment with strong, safe cleaners rather than using harmful chemicals like bleach which may damage your equipment, shorten the life of your restrooms and create a health hazard for your employees.

The FREE Protect Your Investment Kit contains one gallon each of our powerful cleaners: Power Works, Clean Works and a quart of Water Works. Also included is a can of Good as Gone

graffiti remover, six Wipe Out sponges, and two bristle brushes. The kit is completely FREE with the purchase of any drum of deodorizer, cleaner, or 15 cases of Turbo Tubes.

But you must act quickly. **This is a limited time offer.**

Call **(800) 241-7951** to order.

** Limit of one free Protect Your Investment Kit per order.*



99 Crafton Drive, Dahlonega, GA 30533 USA • Phone (800) 241-7951 or (706) 864-3776 • Fax (706) 864-8111 • www.polyportables.com

Only PolyPortables offers high-performance Green Way Products

TOILET DEODORIZERS • TOILET CLEANERS • AIR FRESHENERS • INSECT REPELLANT

All Green Way deodorizers, cleaners and air fresheners are earth-friendly, people-friendly products. They are developed and manufactured in our facilities in Dahlonega, Georgia by Green Way Products, a PolyPortables sister company.



FRUITLAND VACUUM PUMPS. SIMPLY THE BEST

We are the #1 vacuum vane pump servicing the oil fields across North America.

The reason is simplicity.

**We don't need gimmicks or water cooling to serve the harshest of applications.
Simple uncomplicated design that works.**

Features:

- Every Pump "Factory Tested"
- Low Maintenance Cost
- Continuous Duty
- Air - Cooled
- No Washboard
- Vacuum to 28 hg.
- Pressure to 30 psi.
- ISO Certified
- 2 Year Factory Warranty
- Automated Lubrication System
- User friendly Maintenance Features
- Models for Tanks sizes from 1000 to 12000 Gallons
- Drive option include; Hydraulic, Direct, Belt, and Right - Angle
- Proven in all environments (sub-zero to 100 degrees plus)



Markets:

- Industrial •
- Oilfield •
- Septic •
- Grease •
- Environmental •
- Wastewater •

**Used and Proven by
World's Top Liquid
Vacuum Service Companies.**

**Vacuum Pump Training
Courses available*

Fruitland Tool & Manufacturing

" Committed to Quality, Reliability, and Guaranteed Performance "

Contact us today: **1-800-663-9003**
Visit us @ www.fruitland-mfg.com For more info.

Introducing... *the Most Durable & Economical Septic Lid in the Market Today.*

Now Available!
18"

- Durable Roto-Molded Construction
WILL NOT Crack Like Concrete!
- Lightweight Polymer is Easier to
Handle & Transport
- Corrosion Resistant Stainless Steel Screws Included
- For use with Standard 18" & 24" I.D. Corrugated Pipe
- Easy Slide-in
Installation
- Optional
Sand Filled

Cost Effective
**6 Pack
Shipping**



Give Us a Call for
More Information

800.868.0973

Roto Solutions

Don't Waste Money On Expensive Riser Systems!

LEASING SOLUTIONS



If you have special or unique needs,
for straight answers and a quick
response, call Jim Thomas.

Conserve your working capital. Keep
existing credit lines intact, and enjoy the
security of knowing financing is there
when you need it. We offer loan and
leasing plans tailored to individual needs.

- Portable Toilets
- Pumper Trucks
- Water Jetters
- Vacuum Trucks
- Sewer Equipment
- TV Inspection
- New and Used
Equipment

- Programs offer longer terms
for older equipment.
- We do start ups.
- 90 Day Delayed Billing.
- Seasonal Payment Programs Available

*Get Pre-Approved for the Pumper
& Cleaner Environmental Expo*

Prompt, no nonsense financing designed to meet individual requirements.
Payment plans that are generally lower than other finance plans. With years
of experience, we understand the competitive nature of your business.
We're prepared to act quickly and decisively!

Toll-Free 877-333-4539 • www.keycommercial.com

KEY COMMERCIAL CORP.
Commercial Equipment Leasing
"Getting You The Credit You Deserve"

READY FOR IMMEDIATE DELIVERY
CALL US TOLL-FREE: 877-296-2555



2001 International 4900,
 DT466, 210HP, 33,000 GVW,
 7 speed, 236,000 miles

NEW 2300 gallon carbon steel
 tank with 3-inch inlet, 4-inch
 outlet, rear and top manways

Price **\$42,900**

NEW MEC 8000 Battioni
 pump (242 CFM), gearbox
 driven, air PTO

In Stock



IN STOCK

34-foot black Portable Toilet Trailer holds
 18 units. Includes three 3500 GVW Torflex
 axles. 80-inch rear fold-down center T-bar
 to accommodate a handicap unit.

Price**\$9,278**

Thank You



Thank you, Mark and Matt Herman of
 WYCO Construction for purchasing our
 show truck, a new 2007 Sterling with a new
 4200 gallon, 2-chamber tank. We equipped
 it with a hoist, full rear opening door, a
 Giant jetter, and a new NVE 506
 Challenger pump.

SPRING MOUNTS de-
 crease fatigue on your
 tank frame, universally
 mounts to most tanks,
 Easy bolt or weld on
 style, Compact, Heavy-
 duty stress relieved
 springs.

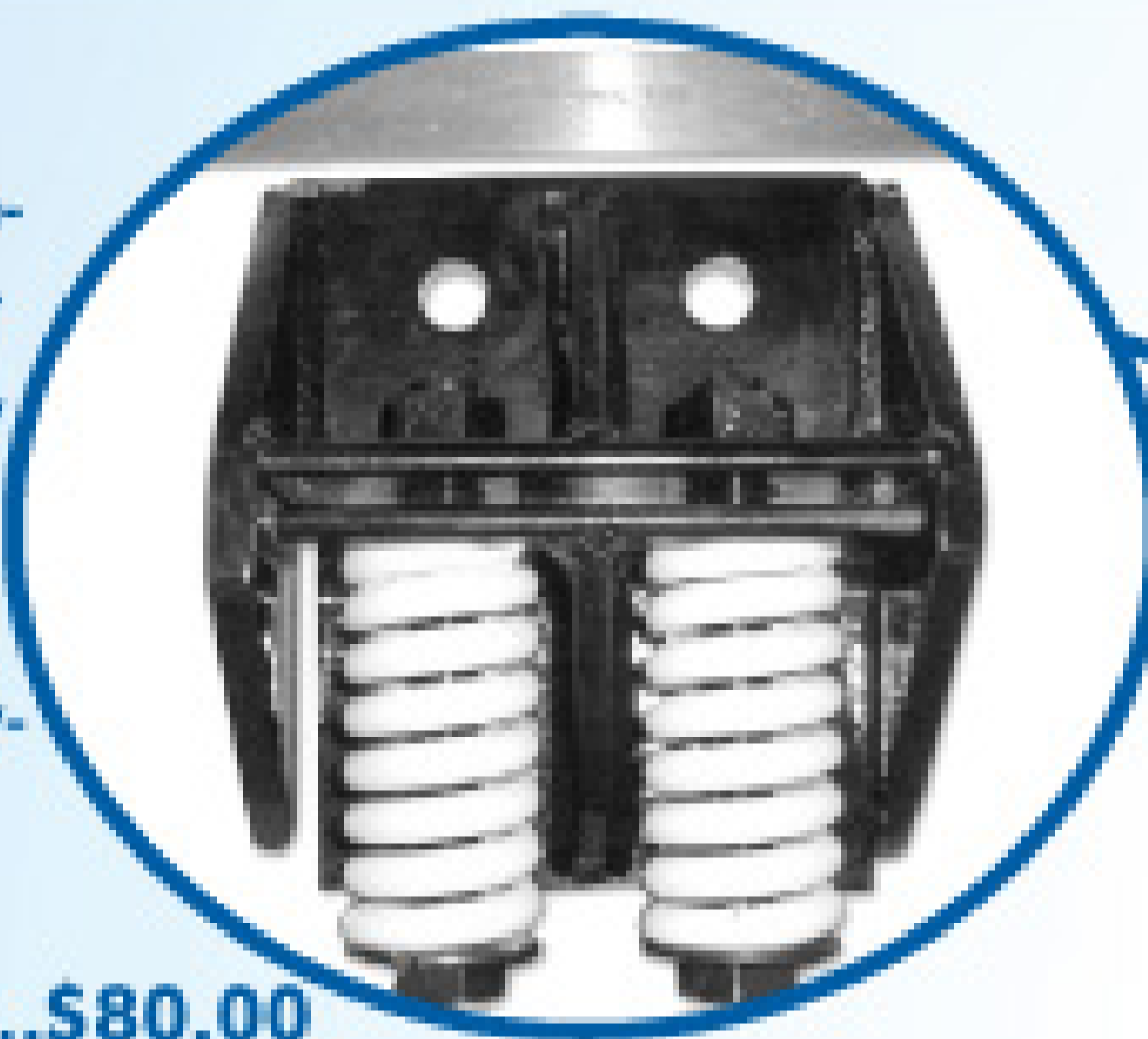

Mounts with springs..\$80.00
Springs alone\$10.00 each

WE

Wee Engineer
 WITH IMAGINATION

Wee Vac

No more 3" sewer hoses running
 through restaurants. The Wee Vac
 fits through a standard doorway
 and can pump up to 45 gallons at
 a time. Wee Vac will even go up
 and down stairs when empty. It
 has a 3" female camlock so it can
 be downloaded into your truck. It
 features a 1 1/2" hose with wand &
 a 105 cfm, 110 volt vacuum pump.
Price: \$1060.00



Thanks to all who
visited us at the
Louisville show!

satisfaction

Test our imagination with
a custom design for you.

WE

Thank You



Thanks to Jim Kristich of A Jax Services for
 purchasing our show trailer. It is 24 feet and
 carries 12 standard toilets.

Thank You



Thanks to Jerry Jones of AAA Sanitation for
 purchasing at the show this 28-foot trailer.
 It carries 14 standard toilets.

P.O. Box 39 Dayton, IN 47941 Toll-Free: 877-296-2555 Phone: 765-296-2027 Fax: 765-296-3027
www.wee-engineer.com

Classy Truck

of the Month



Martin Septic Service

Winchester, Va.

Owners Terry and Susan Carlyle capture a lot of attention for their business with this red and white 2001 Mack Vision built by House of Imports in Miami, Fla. The truck, built in 2007, is powered by a Mack 430 engine with a 13-speed Eaton-Fuller transmission, which pushes a 3,600-gallon steel tank (3,300 gallons waste/300 gallons fresh). A Jurop pump handles the vacuum. The truck also features a 3,000-psi jetter with an automatic hose reel and 200 feet of hose. The outside is appointed with aluminum diamond-plate hose trays and storage boxes and aluminum wheels. The truck was lettered with a simple design by Jay Pennington Signs. The gray-colored cab features air conditioning, CD stereo, cruise control, air-ride suspension, Jake Brake and power and heated mirror. Driver Paul Sites uses the truck for residential and commercial pumping, jetting service lines and cleaning drainfields.

Show us yours!

Got a truck with real WOW appeal? Show it off to Pumper readers — and to the whole world through www.pumper.com!

Send photos of your truck after it has been lettered with your company name, and please pose the owner(s) with the truck. Any industry-related truck is acceptable. Please limit your submission to one truck only.

Your submission must include your name, company name, mailing address, phone number, and details about the truck, including tank size, cab/chassis information, pump information, the company that built the truck, and any other details you consider important. In particular, tell us what features of the truck help make your work life more efficient and more profitable. E-mail your materials to editor@pumper.com or mail to Editor, Pumper, P.O. Box 220, Three Lakes WI 54562. We look forward to hearing from you!

H&M

**Vacuum Pumps
& Equipment, Inc.**

Toll Free: **800-533-5858**
www.hmvacuumump.com



ONLY THE FINEST PRODUCT LINES!

CHALLENGER • CHANDLER • CONDE • JUROP • MORO • ROBUSCHI • THOMPSON TANK • UTILE

PROVIDING SERVICE WORLDWIDE - CALL TODAY!



2008 V.E. Enterprises Eagle Vacuum Trailer



Why Choose A V.E. Enterprises Trailer?

Ten good reasons:

1. Built by ASME certified welders
2. All vertical welds are sub-arc welded providing 100% penetration
3. ASTM SA-36 grade 1/4" steel barrel, heads and baffles
4. Barrel padded with 1/4" plate at all contact points
5. 4" channel ring supports on barrel
6. 4-wide hose troughs with added bracing for pumps
7. Wedge shaped sump with 4" butterfly valves extended close to bumper
8. Trailers prepped with steel shot blast creating a 2.5 mil anchor profile
9. Dual EZ access side / rear entry to walkways (optional)
10. Built for and by our customers with over a dozen design improvements in 2007

* ASME & non-code bobtails / trailers available from 80 to 200 barrels

Setting the Standard For Liquid Storage and Transport Markets Since 1987.

800-234-2329

www.veenterprises.com
sales@veenterprises.com

10834 St. Highway 53 • P.O. Box 369 • Springer, OK 73458



ENTERPRISES, INC.

WHEN YOU REALLY NEED A WORK TRUCK NOW!

1-800-822-8785

www.fssolutionsgroup.com



ID #26707, 1999 Vactor 2110, Roots 824 Blower, Automatic Transmission
NICELY EQUIPPED!



ID #25135, 1998 King Vac 3000 USG, Moro Vane Pump, New Tires
READY TO WORK!



ID #24468, Clean Earth Safe Vac, Roots 1024 Blower, New Paint
READY TO WORK!

Many More Units Available • Call for Details!

Parts and Service
Financing for Used Equipment and Service
Warranties for Most Equipment
We Sell and Service
The Largest Selection of Refurbished
Vacuum Trucks in the World



Wolf Creek Co.

Original Bauer

Portable Piping

Bauer Fittings

Polybarb™ Pipe & Tails

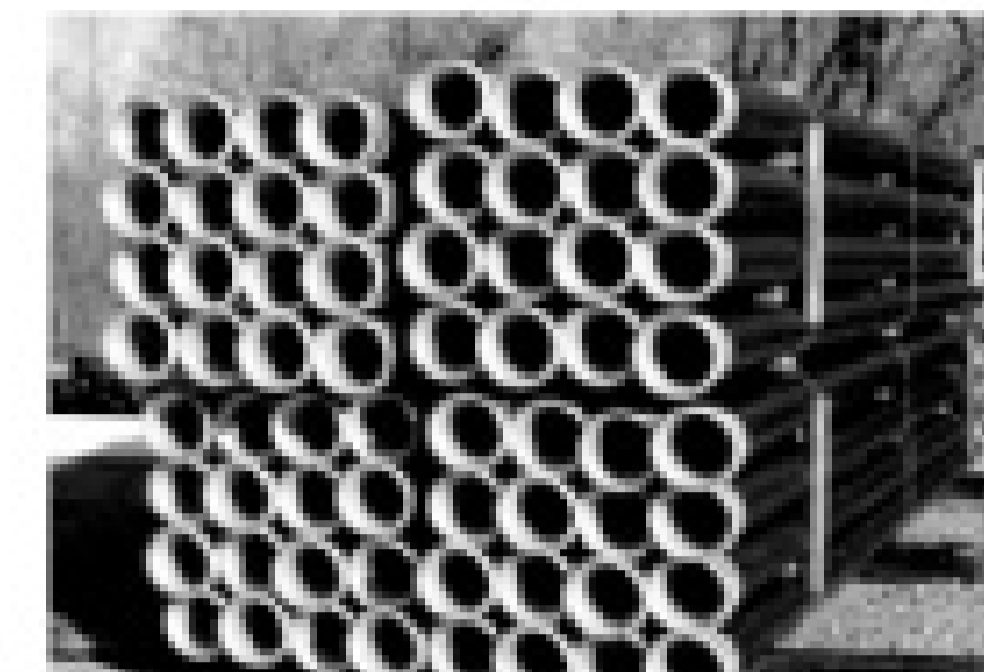

Polybarb™ HDPE pipes and fusible tails available in 4" to 12" diameters up to 40' in length.

Available in weldable, hose insert, and flanged connections. Fittings available from 2" to 12".

Industrial Vac Tubes

We can fabricate aluminum vacuum evacuation or suction tubes per your specifications. Using the Bauer Coupler or Anfor Coupler.



Bauer Pipe

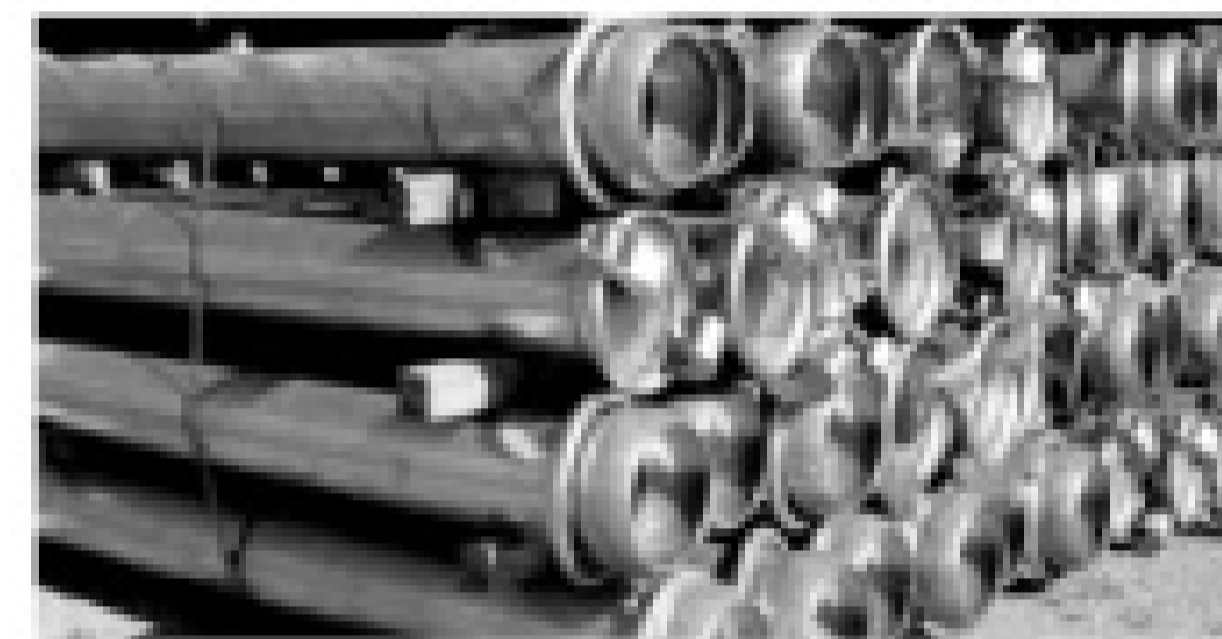

Galvanized piping available in 2" to 12"

800.488.7305 • www.wolfcreekcompany.com

Seal it Tight!
Seal it Easy!
Seal it Fast!



↑ RISER: Dual-wall plastic culvert pipe.

↑ Inner safety lid.

- Easy 10 minute installation!
- Secure fit for all systems!
- Made & sold by septic installers!
- Prevent ground water infiltration and save money at the same time!



Apply foam inside to tank.



Place riser over opening and apply foam.



Place plastic manhole pipe on top.



Install lid.

Are you tired of using risers that are too tall or too short for the job you are completing? Plastic riser pipe will give an exact height each time. Try our system and you will never have to carry concrete pipe and lids again. Save time by not having to assemble multiple sections.

Seal-R™ Lids Available in 12", 15", 18", 24", 30", 36".
Seal-R™ Rings Available in 18", 24", 30".
Inner Safety Lids Available in 18", 24".

Seal-R™ Lids can be personalized. Seal-R™ Lids are constructed with UV stabilizer to resist degradation from exposure to sunlight.

For more information, call us today!

BrenLin Company, Inc
Manufacturers of Seal-R™ Products
Herman, MN
888-606-1998

Fax 320-677-3001 • Email: brenlin@brenlinet.net

www.seal-r.com



Wondering what all the JAG buzz is about?

Ask the steadily increasing number of proud
JAG Mobile Solutions owners.

They'll tell you to expect:

- > Uncompromising Quality
- > Outstanding Customer Support
- > Custom Marketing Materials
- > Qualified Web Referrals
- > Enrollment in the *JAG Owners' Network*



Fantastic

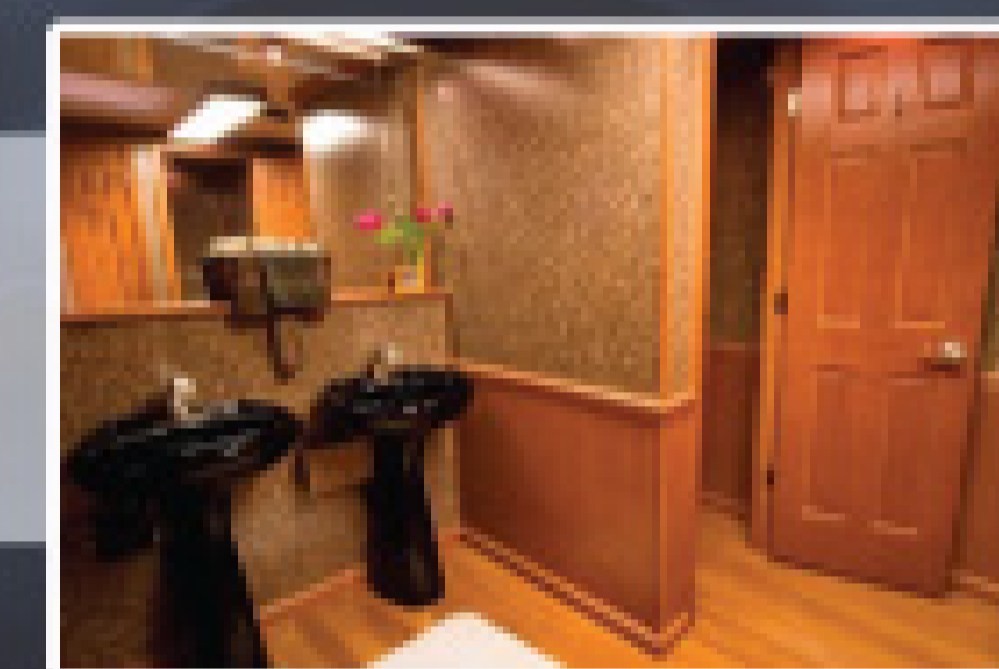
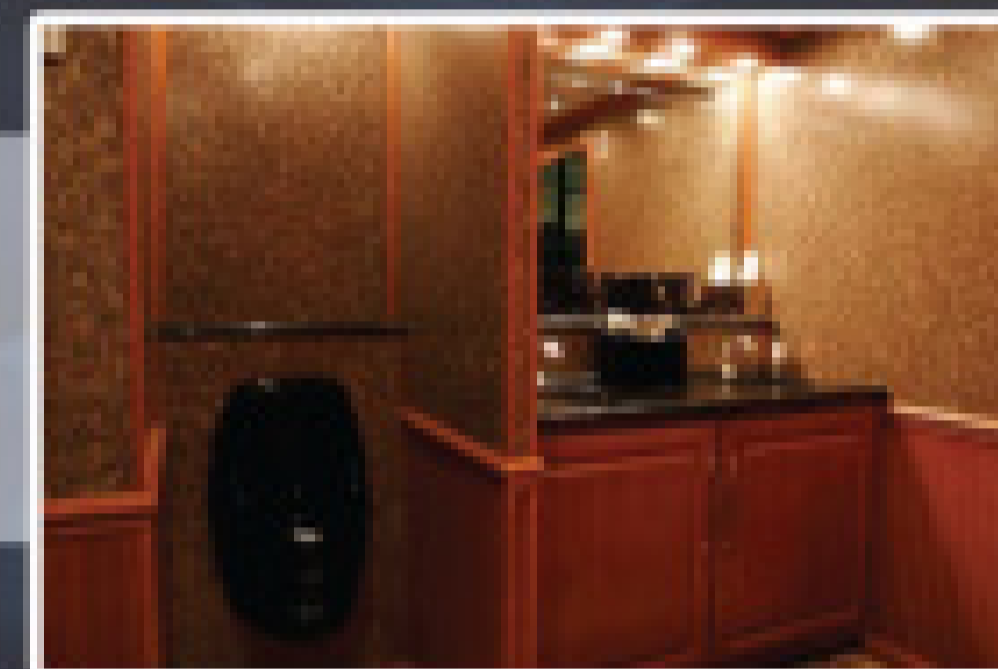

Industrial Giant



Porta Lisa Plus

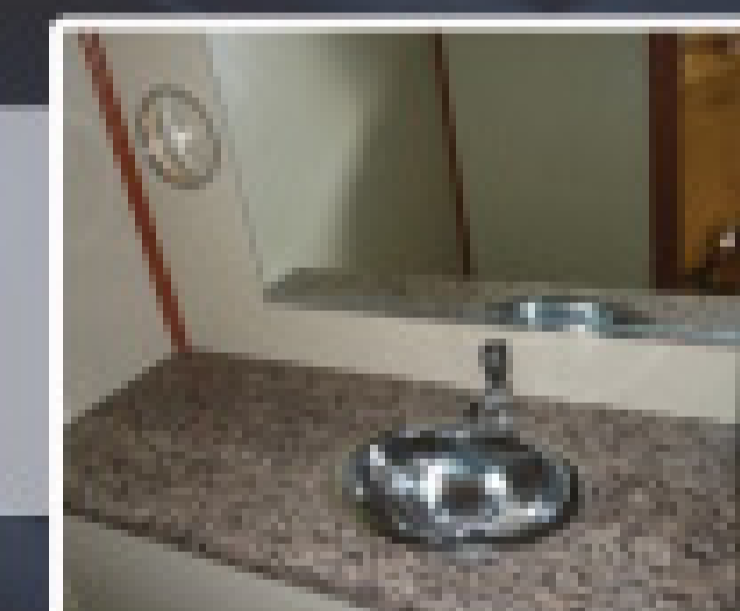
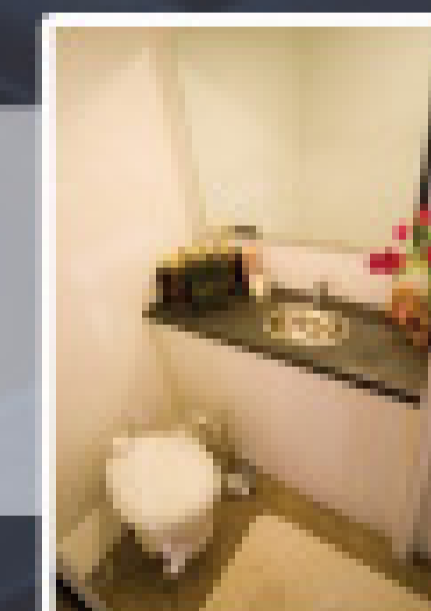
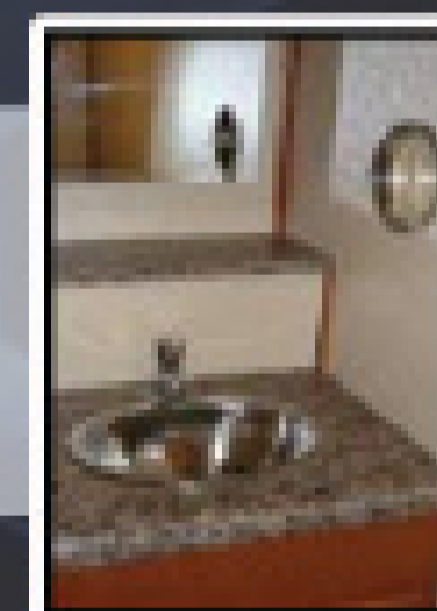
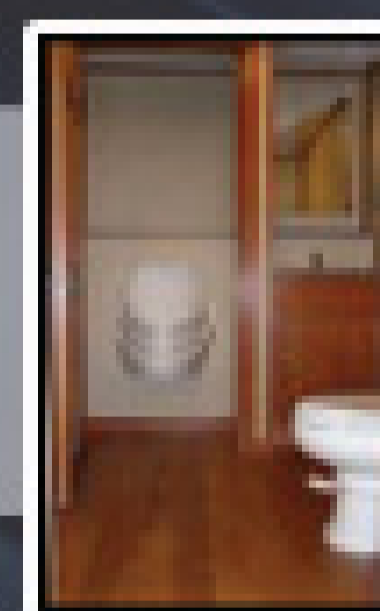

Porta Lisa

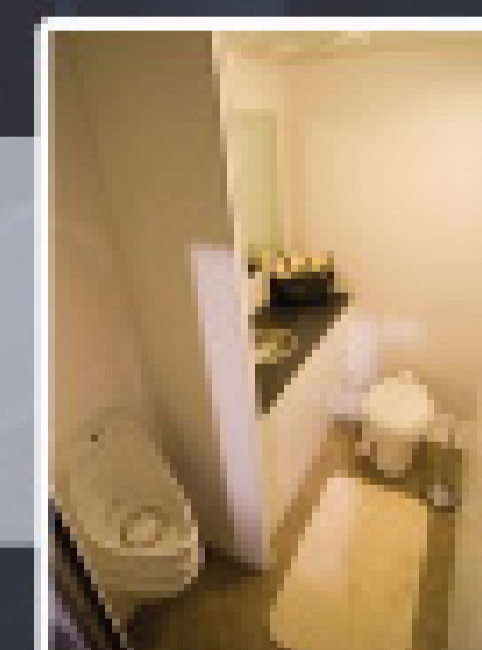
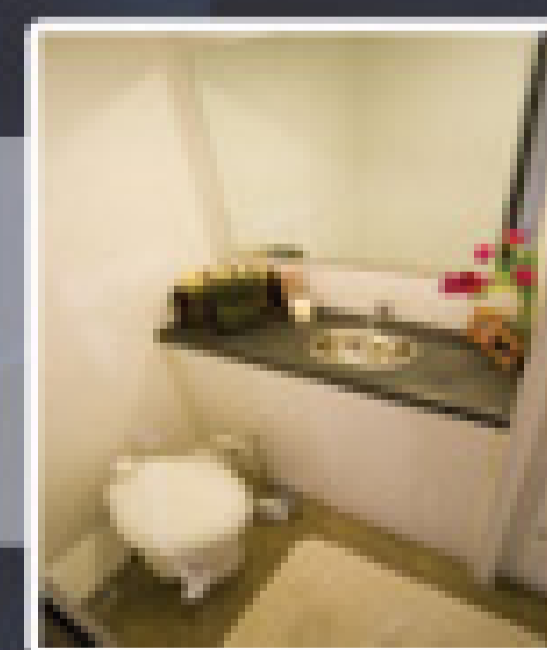

32' Functional Shower

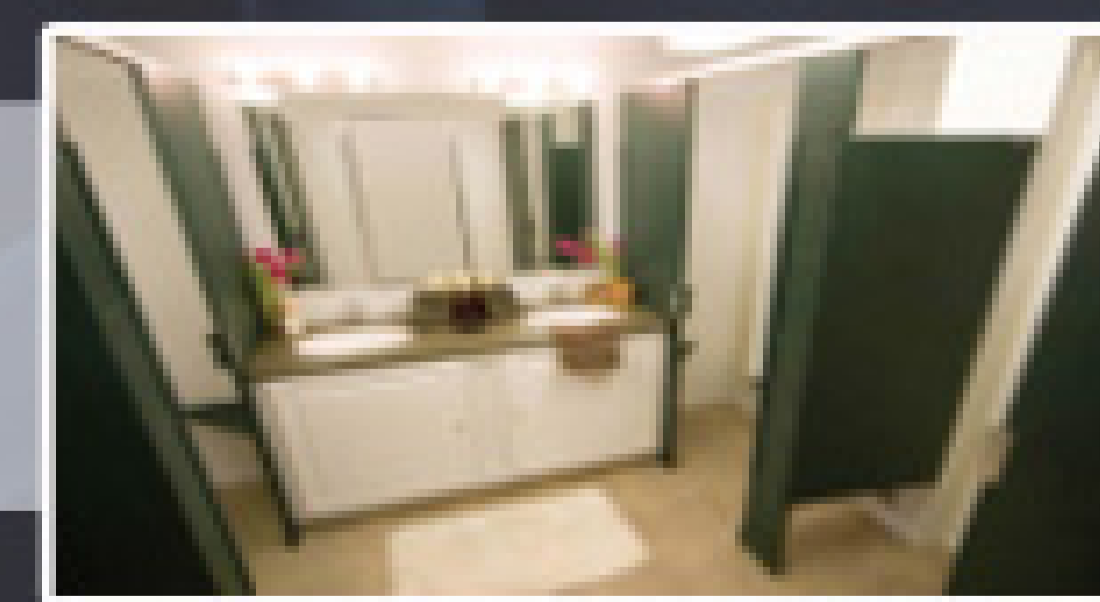
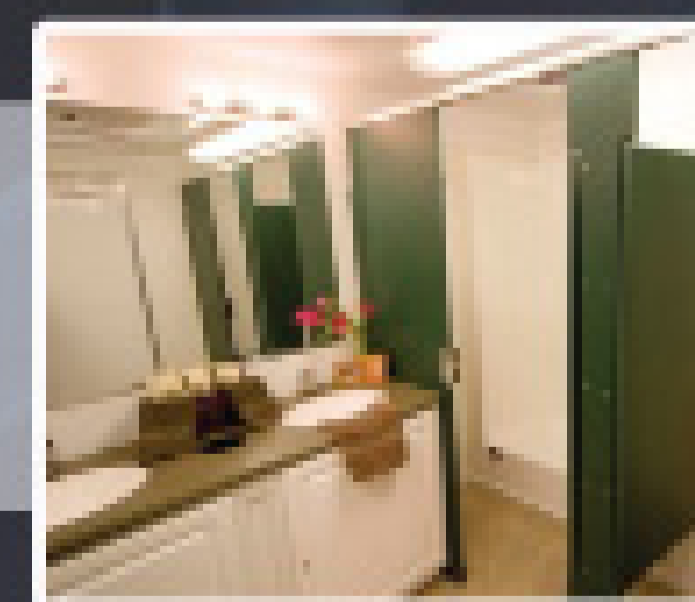

Give us a call at **800-815-2557** or stop by our brand new website **www.jagmobilesolutions.com**
for more information about our Restroom, Shower and Specialty trailers.

Quality People Doing Quality Work

Industrial Vacuum Units

DOT Code & Non Code Vacuum Trailers



Vacuum Septic Units

Aluminum or Steel Tanks in a Variety of Capacities



Portable Restroom Service Units



Thank You Clean Green Porta Potties from Sebree, KY for purchasing this new 950 gallon portable restroom service unit mounted on a 2008 Ford Truck

Mini Vac Trailers

DOT Code & Non Code



Slide-In Units



IN STOCK - Slide-In Portable Restroom Units - Call for Details Industrial Skid-Mounted Units Also Available



P.O. Box 1107 - 135 E Mile Road - Kalkaska, MI 49646
p: 231.258.4870 - f: 231.258.2019 - sales@marshind.com

800.952.1537 - WWW.MARSHIND.COM

Septic-Scrub™

The Demonstrated Drainfield Restoration/Maintenance Solution

Backed By Science ■ Proven with Experience ■ Many Satisfied Homeowners

Septic-Scrub™ is a superior product for the maintenance and restoration of septic system drainfields. Customers appreciate that it is environmentally safe, contains no organic chemicals and does not produce any toxic by-products. Most importantly, **Septic-Scrub works.** It breaks down sulfide buildup in the biomat and soil to allow for better water absorption.

Learn more about Septic-Scrub at www.arcan.com.



arcan

P.O. Box 65
Scotch Plains, NJ 07076-0065

For information on increasing sales and providing a valuable service to your customers, call Arcan Enterprises at **888-35ARCAN (352-7226)**

\$ We've Got the Money \$

For All Your New and Used Equipment Needs

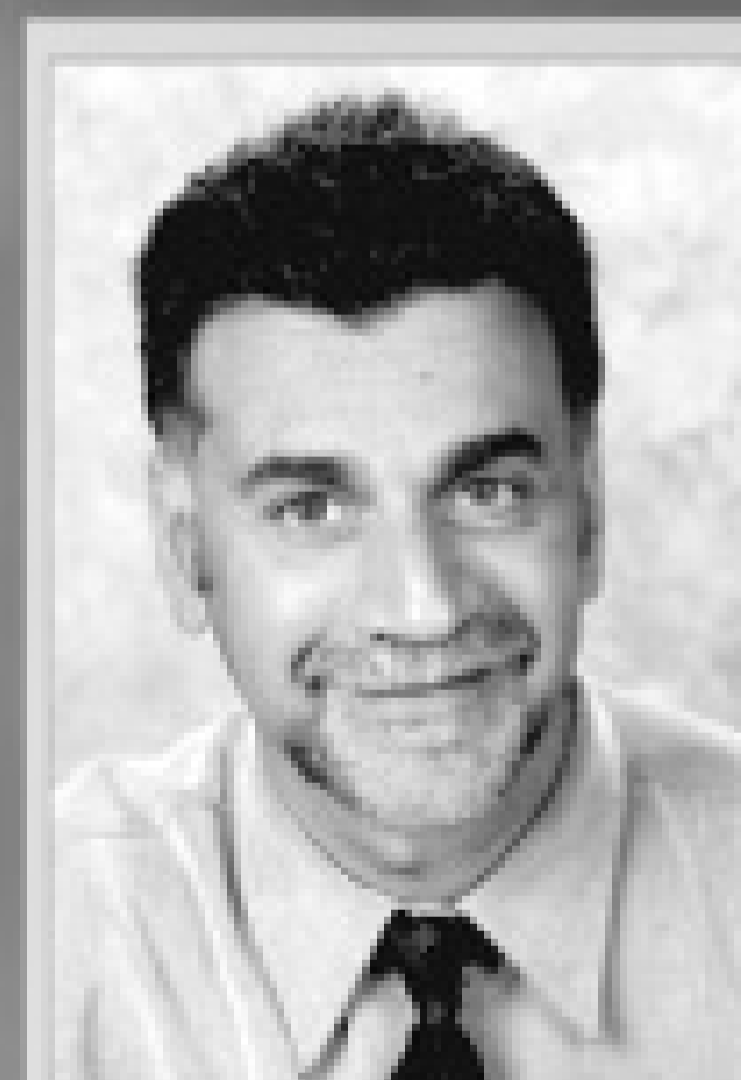

Chuck Territo



Mike Rausch

- \$250k Application Only
- Simple Approval Process
- Lease or Loan Options
- New & Used Equipment
- Flexible Finance Options
- Start Up Programs

Let us put our 35 years of experience to work for you! Call today and see why...

It pays to lease with us!

Granite Leasing Co.

800.246.7997
www.graniteleasing.com

FIVE PEAKS TECHNOLOGY INTRODUCES THE ALPINE



You asked for it... We Delivered!

This spring the Alpine-marches-into Five Peaks, adding its rugged personality to our family of classic portable restrooms. Portable sanitation providers will enjoy the Alpine's answer to their request for a rugged, heavy-duty, industrial strength unit.

- Solid German Engineering
- Modern contours for easy cleaning
- Industrial strength door hinges
- Heavy-duty rotational molded skid bases
- Textured non-slip floors
- Molded side runners with recessed slots for ease of loading and off-loading



The Five Peaks product line includes the popular and stylish Aspen and K2 (available in standard, flushing and elite models), the Matterhorn (ADA Compliant), inside sinks, portable hand-washing stations, sanitation products and accessories, deodorizing products, and service trucks.

To add the Alpine to your product line this season, contact us today at 866-293-1502.



1790 Sun Dolphin Drive • Muskegon, MI 49444
Phone: 231-830-8099 • Toll Free 866-293-1502
Fax: 231-739-2131 • www.fivepeaks.net

 GREEN RIBBON PARTNER



The most rugged, dependable
longest lasting vacuum pumps
in the industry!

wallenstein septic pumps

Components



Dome Style
Hatch



Secondary



Primary



220 CFM



275 CFM



350 CFM



Oil Catch



4 Way
Valve



Stem
Valve



500 CFM

only available through
factory authorized distributors.
Some territories still available.

Series	Rating CFM	Vacuum "HG	HP Engine	Tank Size US Gallon
403	220 @ 1150	27	18	2000
553	275 @ 1150	27	24	2500
753	350 @ 1150	27	30	3500
1054	500 @ 1000	27	40	5000+

Toll Free 1-800-801-6663 fax 519-669-8331 email info@wallensteinpumps.com

Call for product literature and your nearest Authorized Distributor.



1-800-333-9274 East * 1-800-786-9274 Custom
1-800-351-7283 HONDA Parts * 1-800-964-9274
1-800-454-9274 Open Till 7:00pm West

* Apply For 30 Day Terms Account
* Low Interest Lease Plan
* 5 Offices To Serve You
* Free Lifetime Tech Support

SWIVELS  Moismatic & Super Swivels \$22.10 & Up	BYPASS VALVES  From 500-7000PSI 120 Models In Stock \$19.99 & Up	TRIGGER GUNS  Extreme Duty From \$7.99 & Up	HOSE REELS  200' Manual Reel \$79.99	Portable Hose Reels  250' \$299 350' \$349	HOSES  Up To 5800PSI 316Deg F. Rated Up To 200' \$29.99 & Up	TURBO NOZZLES  Up To 5800PSI Best Seller 4500PSI Only \$39.99	PRESSURE GAUGES  Stainless Steel Industrial Quality Up to 6000PSI Only \$23.99	BALL VALVES  Ball Valves Brass, Steel & Stainless Steel New 6000PSI Stainless From \$23.99
Honda Engines  * 5Hp GC \$199 * 6.5Hp GX \$349 * 8Hp GX \$459 * 9Hp GX \$489 * 18Hp GX \$1,099	Honda Twins  * 18Hp GX610K1 \$1,099 * 20Hp GX620K1 \$1,279 * 24Hp GX670T \$1,599	Compact Electric Hand Carry  \$649 EHC2015G 2GPM @ 1500PSI	Compact Honda Hand Carry  Includes Pulse Valve \$799 HJ3028HC 3GPM @ 2800PSI	Hose Reels All Types Available  200' Portable As Shown \$165.98	LT Replacement Engines  Recoil & Electric Start Available	CAT Pump Volume Distributor  Complete Pumps Plumbed From \$179		
Customized Electrics  Auto Stop/Start Hose Reels, Etc	BEST Sellers ALWAYS on Sale  5.6GPM @ 4000PSI \$399 8.0GPM @ 3500PSI \$499 7.0GPM @ 5000PSI \$599 Call For Free Quotation. We Also Stock Pumps With Left Hand Drive, Tapered Shaft, Car Wash Duty, 316 Stainless Steel and Unique Applications 1-800-964-9274	High Performance AR Pumps  13GPM @ 1450PSI \$579 11GPM @ 3000PSI \$629 5.8GPM @ 7250PSI \$1,099 10GPM @ 7250PSI \$2,899 44GPM @ 1500PSI \$4,199 We Stock 1000's of Pumps For Same Day Shipping!	New On Board Hose Reel Option  50' x 100' Available On Some Models	Hose Reels Up To 350' Capacity  Jetter Packages Available All Sizes	Replacement Pumps 1-800-454-9274  Up To 41GPM Up To 7250PSI	Replacement Coil Specialists - For Hot Water Pressure Washers 		
Truck or Trailer Mount  Skid Mount & Tank Feed Options Available On Some Models	Hydraulic Drive Pressure Washers  3.0GPM @ 2000PSI \$539 4.0GPM @ 2200PSI \$649 4.0GPM @ 3000PSI \$689 Call For Details & Hydraulic System Requirements 1-800-454-9274	Cleaning Heads  Full Line Of Cleaning Heads Available	Up To 8GPM Hot Boxes  Adjustable Thermostats, Jumper Hoses & Options Available L.P. Diesel Models Available	HONDA Best Seller  \$2,999 4000PSI Hot 4040HG-115	Frames & Frame Parts Available  Belt & Direct Drive With Custom Options	Mobile Wash - Detailer System  Self Contained On Board Water Supply		

NEW! 2008 Sterling Bullet

Cummins 6.7 Liter Turbo Diesel-305 HP
6 Speed Automatic, 7,000 lb. Front / 13,500 lb.
Rear Axle, Exhaust Brake, AM/FM-CD, Cruise.
1000 Gallon PORTA VAC

650 Waste / 350 Fresh
Single service, Masport HXL4,
Burks DC10 washdown, Hot Shift P.T.O.

\$67,900

Monthly lease from... **\$1316.**

4 Wheel Drive \$72,500

Tank sizes from 800 to 1500 Gallon



200 Services
FREE DEODORANT
With Purchase Of Your
Toilet Truck or Slide -In

1425 Gallon / 3 Compartment Combo Unit

375 Fresh- 800 waste- 250 fresh

2007 International 4300

Auto trans, DT466 'old emission'

22 Gallon hot water

wash system, Jurop PN 33

Tool Boxes, Work

station, Lift gate

Will carry 4 toilets

Call For Pricing!



NOW IN STOCK!

New from **progress tank**

SLIDE-IN VAC UNITS

300 Waste / 135 Fresh

Masport or Conde pump

Honda electric start

12 volt water pump

Totally self contained!

\$8,495



3800 Gallon (2) Compartment Septic Tank

Masport HXL400 water cooled

Jetter system with reel

2008 International 4400

Auto transmission

\$116,247

Plus F.E.T.

Lease from **\$2,324 mo.**



Aluminum Vacuum Trailer

6300 Gallon, 1 Compartment



from... **\$55,000**
Plus FET

Flexible Financing Options To Fit Your Needs.

1500 Gallon Restroom Tank

Standard pumping – dual service, 2 reels

2008 International "Cab Forward"

19,000 G.V.W. auto trans – hyd brakes

\$72,730

Monthly lease from... **\$1454. mo.**



TRANS LEASE, INC.

Randy Satrom or

Cassie Bergo

877-600-6423



Distributor of:



KeeVac
Industries Inc.

Call Kevin. Call Matt. ...Just Call KeeVac

866-789-9440

www.keevac.com



Kevin Keegan
31 Years
Experience

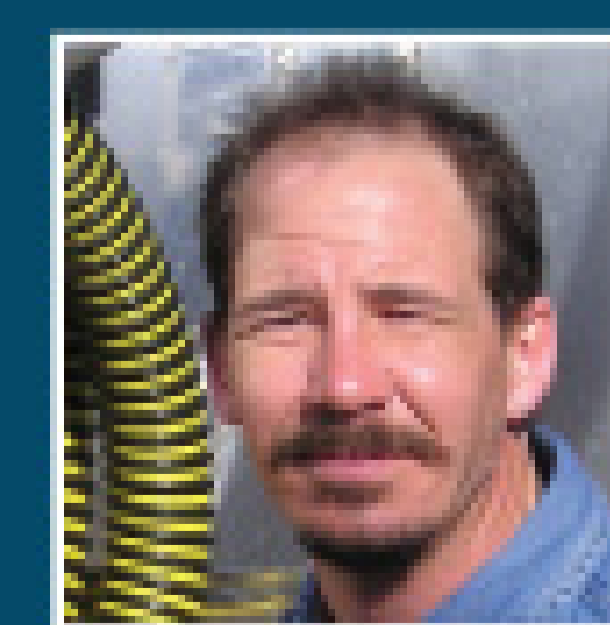
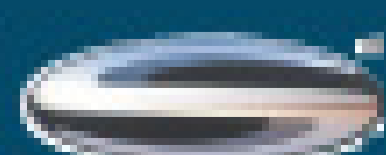

Matt Crowell
17 Years
Experience

Association News

By **Scottie Dayton**

Texas Hosts No-Dig Show

The Gaylord Texan Resort and Convention Center in Grapevine is home to the No-Dig show, April 27-May 2. Four educational tracks representing more than 100 presentations and panel discussions will cover sewer, stormwater, and potable water solutions, theoretical models, gravity and pressure pipes, design/build and assessment concepts, case histories, and mainline and lateral trenchless rehabilitation.

Special pre- and post-conference seminars include new construction techniques and rehabilitation methods, good practices guidelines in horizontal directional drilling and new installation methods, damage investigation workshop, and the NASSCO Pipeline Assessment Certification Program and Manhole Assessment and Certification Program. For more information, visit www.nodigshow.com.

Training & Education

National Association of Wastewater Transporters Inc.

NAWT has scheduled sessions in the following locations:

- June 5 – Inspector Recertification Training, Flagstaff, Ariz.: Call Kitt Farrell-Poe at 928/782-3836; kittfp@ag.arizona.edu
- Aug. 26-27 – Inspector Training and Certification, Tucson, Ariz.: Call Kitt Farrell-Poe at 928/782-3836; kittfp@ag.arizona.edu
- Oct. 14 – Inspector Training and Certification, Tucson, Ariz.: Call Kitt Farrell-Poe at 928/782-3836; kittfp@ag.arizona.edu

Alabama

Licensing classes are the joint effort of the Alabama Onsite Wastewater Association and University of West Alabama. Courses are at UWA's Livingston campus unless stated otherwise:

- May 1-2 – Pumpers
 - May 7-9 – Advanced Installer Level 2
 - June 11-13 – Basic Installer
 - June 26-27 – Continuing Education, Dothan
- Call Allen Tartt at 205/652-3803 or visit www.aowatc.uwa.edu.

California

Certification courses are sponsored by the California Onsite Wastewater Association and National Association of Wastewater Transporters Inc. Check Web site for locations.

- April 17-18 – Inspector Training and Certification
 - April 24 – Soils
 - June 12 – Soils
 - July 17-18 – Operation and Maintenance, Part 1
- Call Cliff Trammel at 707/579-4882 or visit www.cowa.org.

Florida

Courses are at the Florida Onsite Wastewater Association's Training Center in Polk City unless stated otherwise.

- April 7-8 – Master III-Basic Florida Soils
- April 9-10 – Master I-System Design and Function

C A L E N D A R

April 4-5

Alabama Onsite Wastewater Association Trade Show, Pelham. Call 888/737-2162 or visit www.aowb.alabama.gov.

April 7-10

National Onsite Wastewater Association Conference, Cook Convention Center, Memphis, Tenn. Call 800/966-2942 or visit www.nowra.org.

April 15-17

North Carolina On-Site Wastewater Treatment Conference, North Carolina State University, Raleigh. Call Joni Tanner at 919/515-1678 or visit www.soil.ncsu.edu, then Training, Short Courses and Workshops.

April 27-May 2

North American Society for Trenchless Technology No-Dig Show, Gaylord Texan Resort and Convention Center, Grapevine, Texas. Visit www.nodigshow.com.

May 12-15

California Onsite Wastewater Association Conference and Exposition, DoubleTree Hotel, Sacramento, Calif. Call or visit 707/579-4882 or visit www.cowa.org.

June 29-July 2

American Society of Agriculture and Biological Engineers International Meeting, Providence, R.I. Call Sharon McKnight at 269/428-6333 or visit www.asabe.org.

Sept. 10-11

Septage/Grease Trap Waste Treatment Symposium, Holiday Inn Woodbine, Union, Mo. Call 800/236-6298 or visit www.nawt.org.

Oct. 14-15

Delaware Onsite Wastewater Recycling Association Conference and Exhibition, Dover Downs Hotel & Casino, Dover. Call 302/739-9331 or visit www.dowra.org.

Oct. 23-26

Ontario Association of Sewage Industry Services Conference and Exposition, Best Western Conference Centre, Orillia. Call Don Kelloway at 877/202-0082 or visit www.oasisontario.on.ca.

Nov. 5-9

Portable Sanitation Association International Convention & Trade Show, Hilton Hotel Ocean Beach and Ocean Center Exhibit Hall, Daytona Beach, Fla. Call 800/822-3020 or visit www.psai.org.

- April 10-11 – Master II-System Materials & Regulation Requirement
- April 22 – Smart Business Practices, Portable Restroom Industry
- April 23 – Septage and Grease in Florida
- May 6 – Smart Business Practices, Portable Restroom Industry
- May 20-21 – O & M Service Provider Program I, II, III, Miami
- June 10 – Management of Decentralized Systems, Jacksonville
- June 11 – Management of Decentralized Systems, Daytona Beach
- June 16-17 – Master III-Basic Florida Soils
- June 18-19 – Master I-System Design and Function
- June 19-20 – Master II-System Materials and Regulation Requirement

Contact FOWA at 407/830-4381 or www.fowaonsite.com.

Iowa

The Iowa Onsite Wastewater Training Center has the following courses:

- May 14 – Drip Irrigation Dispersal Systems, Ankeny
- June 19 – Basic Soils, TBD

Call Annette Adams at 800/362-2127, ext: 6464 or e-mail Dennis Hayworth at dahayworth@dmacc.edu.

Michigan

The Michigan Onsite Wastewater Training and Education Center at MSU Tollgate Center in Novi is offering these courses:

- April 8-9 – Onsite Wastewater Systems 101
- May 6-7 – Soils Training

Contact Barb DeLong at 517/355-4720 or visit www.egr.msu.edu/age, then Extension & Outreach.

Minnesota

The University of Minnesota Extension has these hands-on workshops:

- April 3-4 – Installing Onsite Systems, Bemidji
- April 11 – Contractor Safety/Pipelayer Certification, Continuing Education, Little Falls
- April 14-15 – General-Continuing Education, White Bear Lake
- April 16-18 – Designing Onsite Systems, Detroit Lakes
- April 22-23 – Inspecting Onsite Systems, Waseca
- April 28-30 – Introduction to Onsite Systems, White Bear Lake
- May 1-2 – Installing, White Bear Lake
- May 5-7 – Pumping and Maintaining, Mankato
- May 5-9 – Pumper/Maintaining and Service Provider Combo, Mankato
- May 6-9 – Service Provider, Mankato
- May 29-30 – Soils, Brainerd
- June 2-4 – Designing Onsite Systems, Mankato
- June 5-6 – Soils, Mankato
- June 10-11 – Soils, Sartell
- June 12-13 – Inspecting Onsite Systems, Waseca
- June 20 – Soils-Continuing Education, Sartell
- June 26 – Soils-Continuing Education, North Branch

Call 800/322-8642 (612/625-9797) or visit www.extension.umn.edu.

Missouri

The Department of Health and Senior Services is offering the following professional CEU courses:

- April 15 – Troubleshooting, Springfield
- April 15-16 – Advanced Installer, Cape Girardeau
- April 16 – Hydraulics, Springfield
- April 22 – Basics on Onsite Wastewater, Chillicothe
- April 23 – Basic Drip Irrigation Design and Installation, Chillicothe
- May 6 – Troubleshooting, Grandview
- May 7 – Hydraulics, Grandview
- May 20-21 – Operation and Maintenance, Camdenton
- May 27 – Troubleshooting, Maryville
- May 28 – Hydraulics, Maryville
- June 17-18 – Operation and Maintenance, Hannibal
- June 24-25 – Operation and Maintenance, St. Louis

Call 573/526-6095 or visit www.dhss.mo.gov/Onsite

New Hampshire

The New Hampshire Department of Environmental Services is offering the following at its Concord auditorium:

- April 8 – Installers, exam
- April 16 – Onsite Designers, review class
- April 22 – Onsite Designers, exam

Call NHDES Public Information Center at 603/271-2975

North Carolina

North Carolina Soils and On-Site Wastewater Training Academy is offering the following courses:

- May 5-8 – Spray Irrigation Systems Operator, Raleigh
- May 13-14 – Writing A Certified Nutrient Management Plan, Raleigh
- May 20 – Introduction to Decentralized Wastewater, Fletcher
- May 21-22 – Onsite Wastewater System Inspector, Fletcher
- June 10-12 – Subsurface Wastewater Operator Training, Fletcher
- June 25 – Soil Survey in the 21st Century, Raleigh

Call Joni Tanner at 919/515-1678 or visit www.soil.ncsu.edu/training.

Rhode Island

The University of Rhode Island Onsite Wastewater Training Center offers these professional development workshops at its Kingston campus:

- April 17 – Bottomless Sand Filter Design and Installation
- April 30-May 1 – Conventional Onsite Wastewater System Inspection
- May 8 – Innovative and Alternative Technology Overview
- May 14 – Hands-On Component Installation
- May 29 – Innovative and Alternative Systems Field Tour
- June 4-5 – Innovative and Alternative Systems Operation and Maintenance
- June 18 – Soils Basics for the Onsite Wastewater Contractor (contact Mark Stolt)
- June 25 – Bottomless Sand Filter Design and Installation

Call Holly Meehan at 401/874-5950 or Mark Stolt, when directed, at 401/874-2915 or visit www.uri.edu/ce/wq.

Texas

The Texas Onsite Wastewater Association is offering a Basic Maintenance Provider course on May 8-9 in the Beaumont area. Call 888/398-7188 or visit www.txowa.org.

Washington State

The Washington On-Site Sewage Association and Washington State Department of Health in cooperation with Washington State University are offering these certification courses at the training center in Puyallup unless stated otherwise:

- April 16 – Pumps
- April 23 – Design/Install Subsurface Drip Systems
- May 6-7 – Combined Basics of Onsite Sewage
- May 14-15 – Installation Basics, Part 2
- May 20 – Mounds/Sand Filters
- May 22 – Maintenance Basics, Bremerton

Call John Thomas at 253/770-6594 or visit www.wossa.org. ■

**Non-CDL
19,500 GVW to
66,000 GVW
Septic / Grease Trap
Portable Restroom
Vacuum Service**



**Complete
'Work Ready'
IN STOCK
Selection!**

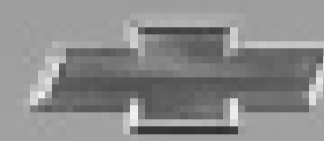
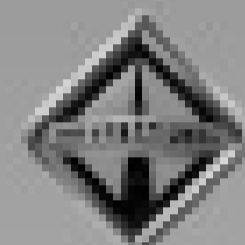

Contact: Mark C. Langworthy **800-261-9009**
e-mail: mlangwor@tanktruckservice.com www.tanktruckservice.com
Tank Truck Service & Sales, Inc.
25150 Dequidre, Warren MI 48091

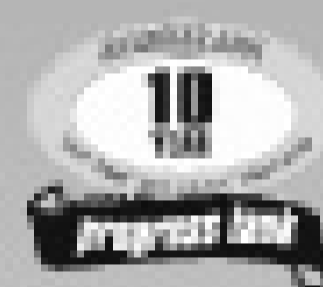

Get a Life!

...with software that will give you your life back!

Summit™ XP Service Profit Builder™

Customer & Job Tracking
Reminders & Repeat Jobs
Dispatching & Mapping
Parts Inventory
QuickBooks® Link
...and much more!

DEMOS ONLINE!

Demo DVD/CD also available

Ask about our other software programs for:

- Portable restroom & other rental businesses
- Sales Contacts • Incentives
- Fleet Maintenance (Vehicles/Equipment)

Easiest to use!

...Over 25 years experience



Ritam Technologies, LP

Sales: 800-662-8471 Email: info@ritam.com Web: www.ritam.com

THE LEADER IN PUMPER/CLEANER REELS SINCE 1933



Washdown and Clean Up With Hannay Reels

Applications

- Power washing
- High pressure washing
- Vehicle and equipment washdown and clean up

Advantages

- Flexibility of mounted and portable designs
- Hose pickup and storage is quick and neat
- Tried and tested technology
- Tough reels for the toughest environments

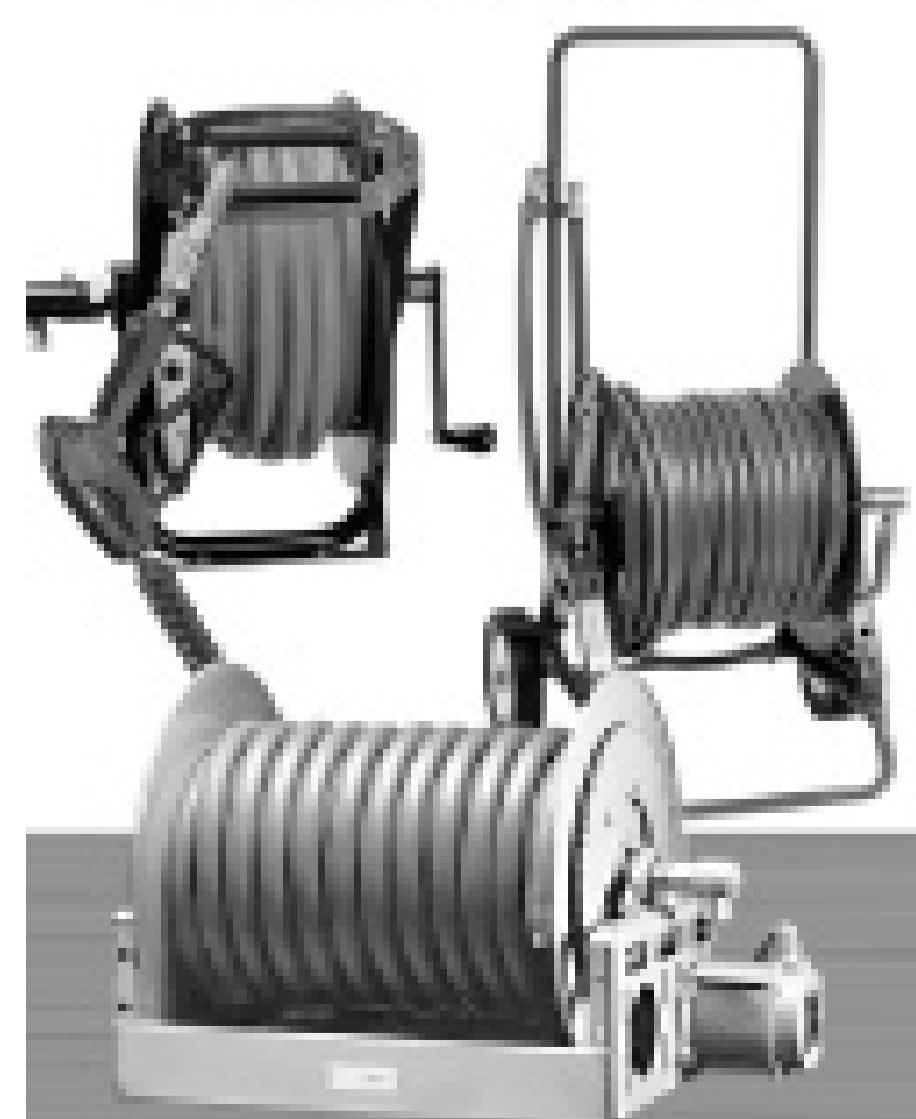

Download or call for your FREE catalog
<http://go.hannay.com/S15> 877-467-3357

Tired of your Web Site?

Let COLE Publishing
redesign and host
your web site!



• **Competitive Rates**

• **Fast Service**

For information call

1.800.257.7222

colepublishing.com/web

Mid Continent Truck Sales, Inc.

891 Adkins Hill Rd. • Norman, OK 73072 • 405-329-5365 • Fax: 405-329-5381 • After Hours: 405-288-6502 • www.vacuumtrucksales.com

Trucks - Trailers - Vacuum Tanks - Pumps



2001 IH 4700, DT466E, Allison auto, non-CDL, air brakes, new MEC 6500 vacuum pump, new 1100/400 vacuum tank.



2000 Freightliner, Detroit 60 series (430/470 hp) w/fresh overhaul, 10-speed, double frame, new Wally 753LNHR vac pump, new 3400 gallon vacuum tank.



2001 Freightliner FL70, Cat 3126 (230 hp), 6-speed, 33,000 lbs., double frame, new MEC8000/PAL vac pump, new 2300 gallon vacuum tank.



1981 IH S1854, DT466, 10-speed, Wally 403 HR vac pump, 1600 gallon vacuum tank.



1998 Freightliner FL60, Cummins 5.9 (210 hp), 6-spd., Masport H75V vacuum pump, General 47 series triplex, 1100/200 gallon vacuum tank.



LET US QUOTE YOUR NEXT VACUUM TANK!



1990 IH 9400, Cummins NTC350 w/fresh inframe, 9-spd., new Wally 753LNHR vac pump, 3500 gallon vacuum tank w/full opening rear door.

MID CONTINENT TRUCK SALES

manufactures and stocks all necessary components to complete your vacuum system. Whether it's pumps, valves, moisture traps, oil catch mufflers, pump frames, etc.

CALL US BEFORE YOU BUY!

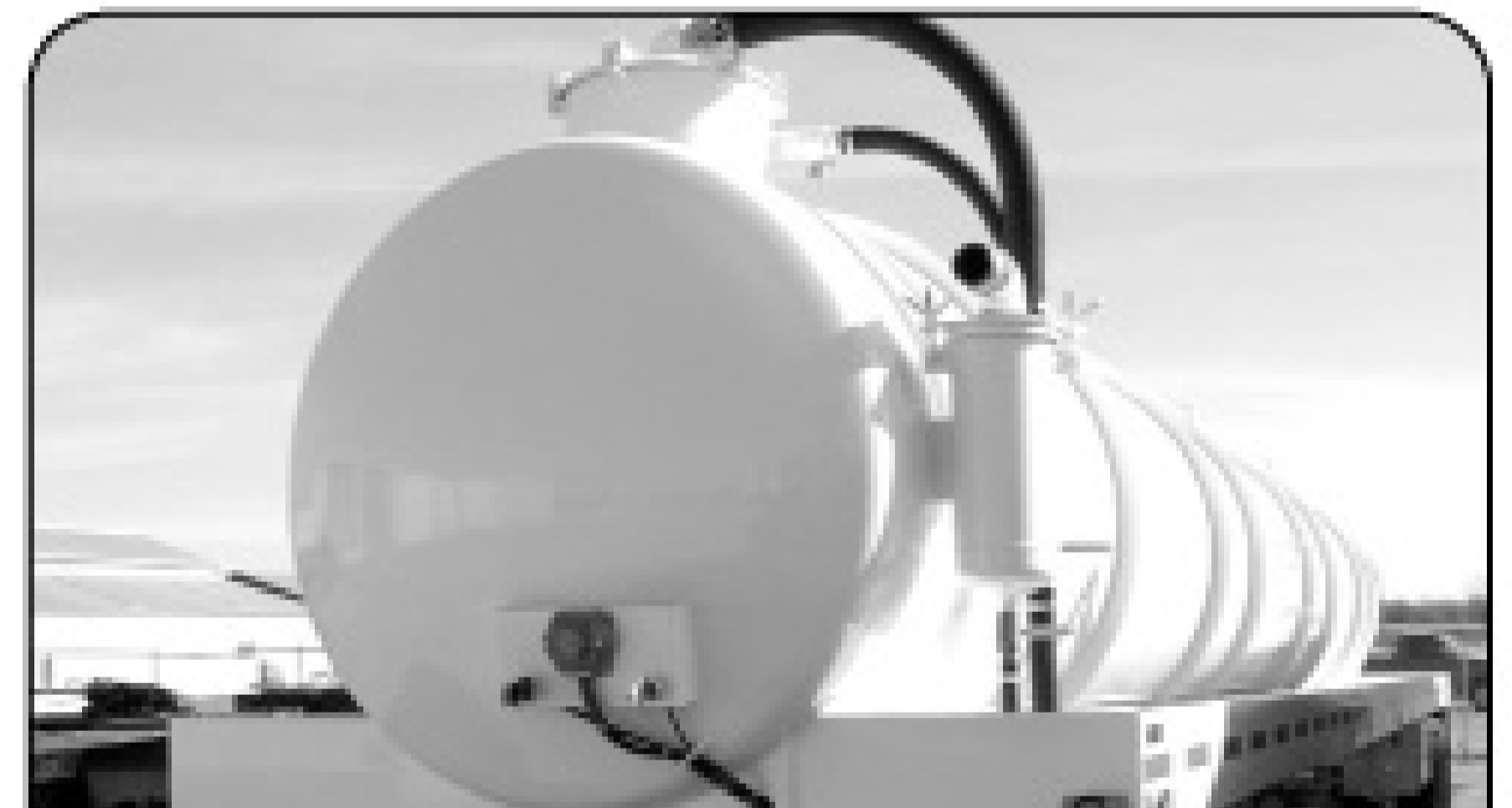

New Fluidmaster 5460 gal. vacuum trailer in stock. Also several used vacuum trailers in stock.

Keep Pumps
Since 1946

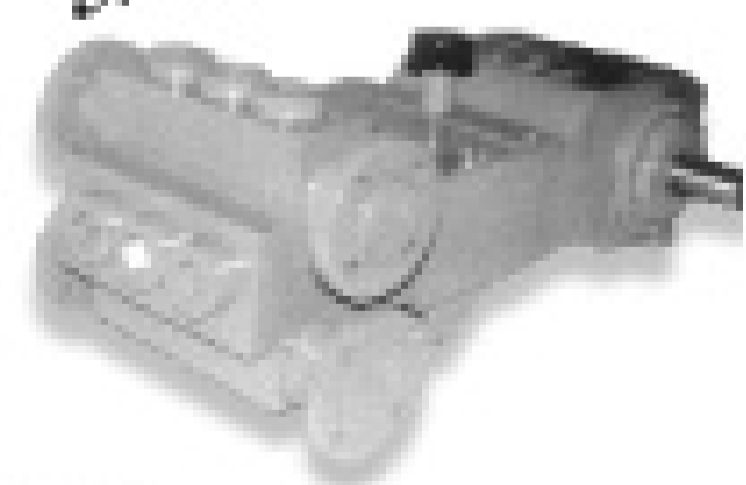

Masport

NVE

AUTHORIZED DISTRIBUTOR



vallenstein
vacuum pumps

BOWIE



FLUID AND SLURRY
PUMPS

WE CARRY MOST BRANDS OF VACUUM PUMPS AND PARTS!



WE WILL BUILD TOILET UNITS TO YOUR SPECS!

Call DAVE PERRY for TRUCK quotations and CHUCK RODGERS for TANK quotations.

APRIL Pumper CLASSIFIEDS

2008

- ▶ Advertising
- ▶ Aerators
- ▶ Bucket Machines
- ▶ Businesses
- ▶ Business Opportunities
- ▶ Cable Machines
- ▶ Computer Software
- ▶ Dewatering
- ▶ Drainfield Restoration
- ▶ Drain / Sewer Cleaning Equipment
- ▶ Dredges
- ▶ Excavating Equipment
- ▶ Hazardous Waste Units
- ▶ Hydroexcavation
- ▶ Jettors-Trailer
- ▶ Jettors-Truck
- ▶ Jet Vacs
- ▶ Lease Financing
- ▶ Locators
- ▶ Miscellaneous
- ▶ Parts & Components
- ▶ Pipeline Rehabilitation
- ▶ Portable Restrooms
- ▶ Portable Restroom Sinks
- ▶ Portable Restroom Tanks
- ▶ Portable Restroom Trailers
- ▶ Portable Restroom Trucks
- ▶ Positions Available
- ▶ Positions Wanted
- ▶ Positive Displacement Blowers
- ▶ Pressure Washers
- ▶ Pumps-Dredge
- ▶ Pumps-High Pressure
- ▶ Pumps-Submersible
- ▶ Pumps-Vacuum
- ▶ Pumps-Water
- ▶ Rodding Machines
- ▶ Roll-Off Containers
- ▶ Roll-Off Trailers
- ▶ Roll-Off Trucks
- ▶ Root Control
- ▶ Safety Equipment
- ▶ Septic Tank Forms
- ▶ Septic Trucks
- ▶ Service / Repair
- ▶ Slide-In Unit
- ▶ Sludge Applicators
- ▶ Tanks
- ▶ Tools
- ▶ Trailers- Vacuum / Tanker
- ▶ TV Inspection
- ▶ Vacuum Loaders
- ▶ Vanes
- ▶ Vehicle Tracking
- ▶ Wanted
- ▶ Wastewater Transfer
- ▶ Waterblasting

ADVERTISING

REMINDER POSTCARDS: Advertise full color postcards of your truck, service or products. Great marketing tool. Visit www.postcardprinting.com. Toll Free 1-888-334-4553. (PBM)

BUCKET MACHINES

GRADEBLADE — Convert your toothed bucket to toothless in 60 sec., NO tools needed, fast, inexpensive, fits backhoes, mini-excavators and large excavators. 1-888-372-8933 FREE DVD, literature. www.gradeblade.com. (P14)

BUSINESSES

FOR SALE: 23-year-old restaurant service company specializing in hood system cleaning and ceiling restoration. Serving WV, OH and KY. Large loyal customer base. Grossing average \$500,000. All vans, equipment and experienced service techs in place. \$300,000. Will train. 304-372-2158. (CP7)

FOR SALE: SOUTHERN CALIFORNIA SEWER BUSINESS: Sewer and septic company in Redlands, California established late 1940s. Most respected sewer company in area. A lot of room for growth. In center of nation's largest housing development. Owner retiring; can assist with transition of company for at least one year. Equipment includes: 3 pump trucks (one needs work), 2 backhoes, 2 skid steers, 2 mini excavators, 1 dump truck, 1 equipment trailer, 1 skip loader. Also miscellaneous buckets, compactor, generator, air compressor and other tools. \$825,000. Please contact Tim Patrick 909-795-6164. (P5)

BUSINESSES WANTED: Septic pumping, grease trap, drain cleaning and other ancillary businesses wanted. We are buying well run businesses in New England, Mid-Atlantic and Florida. All opportunities will be given proper consideration. Confidentiality ensured. Will move quickly for the right opportunity. Serious inquiries only. Please contact Richard Bedard @ 617-326-3344 or rbedard@bwseptic.com. (PBM)

BUSINESSES

2003 F350 4X4 diesel Dyna Vac 125/300 vac system new April 07; Dyna Vac 125/300 vac system spare new in 2003; Explorer trailer hauls 12 toilets, new in 2004; 4 flush toilets, with sinks, 2 handicap toilets, 63 reg. toilets. Asking price \$85,000. Business located in Worcester Boston area. Computer and telephone number included in price. Contact Attorney William Cotting. 508-845-6006. (P4)

Septic service, repairs, excavating co. Phoenix, AZ. est. 1953. Does \$2.1 million gross, \$425K plus annual net. Assets \$600K plus. Retiring. Price \$1.2 mil. Call Joe Herron, West USA Realty, 480-948-5554. (P5)

Septic, sewer and drain cleaning business located near resort area. High potential with lots of room for growth. Sale includes 3.9 acres of land with 2000 sq. ft double wide home, single wide mobile home with 1-1/2 baths, office trailer, 40x56 garage, 3 Keith Huber Dominator combination trucks, 2 locating ferrets, Cues camera, 2 Scooter cameras, Terralift with truck and trailer, backhoe, 5-ton dump trailer, plus many more extras. Service area is the Peninsula of Maryland and Delaware. Call Mike for details. 410-430-3431 or 410-546-2162. (P4)

Family owned pumper and septic installation business offered in sunny, warm, New Mexico. Large customer base, state mandated pumping on all home transfers. \$150-\$300K yearly income possible. Asking \$140K negot. Serious inquiries only. 1-575-434-5158. (P6)

BUSINESS FOR SALE: Unique opportunity to own a well established septic pumping business w/portable toilets. Located in scenic mountain valley within family oriented community and schools. The nearest competition for portable toilets is 40 miles away. Business established 15 plus years with growth each year. Available with business 40x80 shop and office on 2 acres, industrial property. Call for information 406-222-0025 M-F 8:00 am to 5:00 pm. (P5)

BUSINESSES

Long Island, New York: For Sale: Cesspool, Septic, Sewer and Drain Cleaning Company For Sale. 2 pump trucks, 2 porta-pottie trucks (service and delivery). Quality workmanship, has established 3000+ loyal customer base. Great opportunity for right person. Jump in on busy season! Money maker! Debt free! Office/shop/yard also available. Call for more information. 631-472-0677. (PBM)

Thriving septic business in the beautiful northwoods of Wisconsin. One 3500 gallon tank on a 2003 Sterling Acterra, 210,000 miles. Room for growth in area. 2007 sales \$187,000. Asking \$170,000. 715-820-1709. (P4)

Septic Tank Pumping & Grease Business in Tennessee: Owner retiring, family owned, in business for 20 years. Two trucks: 2002 Peterbilt, 3,000 gal. tank; 1999 Chevrolet, 2500 gal. tank, garage kept and regularly maintained. Great opportunity for growth. \$160,000 last year; \$200,000 this year. Residential & commercial. \$250,000. 865-579-5699. Ask for Bob or Patti. (P4)

FOR SALE: Septic pumping business located in lake region, central New Hampshire. 20 years in business. Government contracts. Three trucks. Owner retiring. \$77,000. Call 772-664-1931 or 603-279-4063. (P6)

FOR SALE: Septic and portable toilet business Located in Highland, MI. Family owned for 60 years. 3 pumpers, 1 portable toilet truck, 1 dump truck, backhoe, dozer, approximately 90 portable toilets. Excellent client base, residential and commercial. Selling price \$350,000. Further details for serious buyer only. 248-889-0483 or 248-420-7779; email jan7mom@sbcglobal.net. (P4C5)

FOR SALE: Family owned portable toilets restroom business. Retiring after 33 years. 900 units plus handicapped units, portable wash stations, 4 trucks, 5 holding tanks, 4 trailers. Located in North Western Illinois. Serious inquiries only. Call 1-800-698-6928 or 815-441-8527. (P4)

BUSINESSES

SEPTIC PUMPING, INSTALLATION AND POTTYHOUSE BUSINESS: Central Illinois. Established 13 years, 2000+ customer base. Great expansion for your current business. Most work in 30-mile radius. Will stay on for 6 months of training if needed. \$125,000. OR buy only name, phone number and customer files, \$110,000. 217-417-0374. (P5)

FOR SALE: Septic and Portable Toilet Business located in White Mountains, Arizona. 150 toilets, 2 ADAs, 3 trucks. For more info, respond to: 11448 East Monte Ave., Mesa, AZ 85209. (PBM)

BUSINESS OPPORTUNITIES

Attention PolyJohn Owners: Receive a **free CD-Rom** of our products to use in your company marketing efforts. Ask your PolyJohn business coach in your area to send you this material today. 1-800-292-1305 Kell. (PBM)

WWW.ROOTERMAN.COM. Franchises available with low flat fee. New concept. Visit web site or call 1-800-700-8062 x26. (CPBM)

National Grease Recycling Inc. Let us teach you how to recycle restaurant's waste fryer grease and oil (yellow grease) only. **No trap grease.** Big \$. Over 30 yrs. experience. Will guide you through complete process from collection to processing to marketing to end users. Don't lose your trap business to competitors that offer both services. Call for information. Dewey Walker. 813-752-9535 or 813-758-2552. (PBM)

COMPUTER SOFTWARE

Pumper Plus Billing Software: Regularly \$795. Mention this ad in Pumper.com and purchase for only \$595. Pumper Plus is a billing software package from Galaxy Systems, www.galsys.com/pumperdemo.asp, that handles billing for septic pumping and portable toilet service-type companies. Inquire at solutions@galsys.com or call 800-985-3029. (PBM)

PLACE YOUR AD ONLINE AT www.pumper.com - IT'S ALWAYS THERE TO MEET YOUR BUSY SCHEDULE

COMPUTER SOFTWARE

WINTAC is the #1 software for scheduling, billing, CRM, service tracking, accounting, marketing, vehicle management. FREE demo at www.wintac.net. 1-800-724-7899. (P6)

DEWATERING

Alar 660 vacuum drum, components built on skid, 7 years old, works great on septage. We've outgrown system, will do 1500-2000 gph. Call Steve 520-744-1100. (P5)

DAF, 6X12 F.R.C. All stainless steel w/2 dissolved air pumps. Top paddle and bottom worm drive skimmers removes suspended solids particles and colloidal materials from liquid waste, such as fats, oils, grease, latex, pump and paper fiber. Treating approx. 140 gallons per min. \$23,000. 770-409-1615. (CP4)

Alar, Model 650, very good cond. Completely automatic with all controls and panels, filters down to 1/2 micron, sludges generated by septic and grease haulers. Reducing BODs, F.O.Gs, TGS, total phosphorus, meters and NH3-N. \$35,000. 770-409-1615. (CP4)

Buy - sell - trade - lease: Filter presses, belt presses, vacuum filters, filter cloth, dewatering bags, tanks, mixers and more! Call Waste Treatment Equipment Specialties at 440-808-8844. www.wescoequip.com. (PBM)

Two 40-yd. dewatering boxes and one polymer mixing and pumping units with Seepex sludge pumps. 5 years old. Excellent condition. Asking \$20,000/box and \$25,000/pumping unit. Call 1-506-672-2100. (PBM)

DRAINFIELD RESTORATION

1996 Terralift, 700 hours, has two probes, beads and tandem trailer. Going out of business, medical reasons. \$12,000. 515-321-2366. Chuck. (P4)

1996 Terralift, low hours, well maintained, updated control box; \$12,000. 251-209-6031. (P15)

IF YOU ARE USING AN
800 NUMBER

IN YOUR AD, BE SURE IT CAN BE USED
IN ALL AREAS NATIONWIDE.

HAZARDOUS WASTE UNITS

1997 Peterbilt 379 heavy spec with a 3200 gallon, carbon steel, DOT certified, Cusco master vac wet/dry industrial vacuum loader with dual baghouse, PD blower, rotary vane vacuum pump (no boom), 8 top fitting on rear door. Full open rear door dump unit. Very clean. (Stock #1499V) www.VacuumSalesInc.com, (888) VAC-UNIT (822-8648). (PBM)

2008 Sterling LT9500 triaxle with a new Presvac power vac 3,500 gallon carbon steel DOT certified 412 wet/dry industrial vacuum loader, 3800 cfm, 27" Hg PD blower with PVB750 vane pump. 8" top load boom with wireless remote pendent, 70 gallon aluminum tank with washdown system. This is on our lot and ready to go. (Stock #13294A) www.VacuumSalesInc.com, (888) VAC-UNIT (822-8648). (PBM)

1994 Mack RD686ST heavy spec triaxle with Presvac 4400 gallon carbon steel 2-compartment (1200/3200) DOT certified vacuum tank unit with Masport water-cooled pump. Excellent truck; very well taken care of. This could be a real money maker for the right application. (Stock #5371C) www.VacuumSalesInc.com, (888) VAC-UNIT (822-8648). (PBM)

2009 Peterbilt 340s loaded with every option except with automatics with a new Presvac 3200 gallon carbon steel, DOT 412 certified, full open rear door, dump style units. PVB750 vacuum pumps. (Stock #13335 A,B,C&D) In production for April & May. www.VacuumSalesInc.com, (888) VAC-UNIT (822-8648). (PBM)

2001 Freightliner C120 factory refurb. heavy spec with 10-speed auto shift, new Presvac 3200 gallon carbon steel, DOT 412 vacuum tank with Fruitland RCF 500 pump. 12 month/10,000 mile and drive train warranty. (Stock #13329V) www.VacuumSalesInc.com, (888) VAC-UNIT (822-8648). (PBM)

1990 Presvac 5,000, stainless steel DOT certified vacuum tank trailer with PV750 pump, Deutz diesel engine package. Mirror type polish finish tank with trim paint black. Less than the price of a new one with a great thickness report. (Stock #5008V) www.VacuumSalesInc.com, (888) VAC-UNIT (822-8648). (PBM)

HAZARDOUS WASTE UNITS

2008 New Presvac 5,500 gallon, carbon steel, DOT 412, vacuum tank trailer with PVB750 and Deutz diesel engine package. (Stock #13325) www.VacuumSalesInc.com, (888) VAC-UNIT (822-8648). (PBM)

ATTENTION: Fleet of Mack vacuum, emergency response service trucks for sale/trade by owner. Tanks and misc. pumping equipment. 417-619-5111. (PBM)

JETTERS-TRAILER

1987 Aquatech, 600 gal. tank, Myers pump, 35 gpm, 1800 psi, industrial 4 cylinder gas engine, great condition. \$10,000. Call Harry 843-556-4320. (P4C5)

2006 Spartan 798 jetter, 4000 psi @ 18 gpm. Only 25 hrs. Like new. \$25,000 OBO. In California. 209-854-1816. (CP4)

1993 SECA Model 747 4000 trailer jet, 4 cyl. diesel, Myers pump, 18 gpm, 4000 psi. Was a city owned unit. 714-639-8352. www.empireequip.com. (CPBM)

New PipeHunter Model 38T44 jetting unit, trailer mounted unit, w/335 Poly water tank, 4,000 psi @ 25 gpm, 600' of hose and attachments. In Stock!!! (Stock #13317) www.VacuumSalesInc.com, (888) VAC-UNIT (822-8648). (PBM)

2 SECA trailer jets. Both have Myers 35 gpm, 2000 psi pumps. New paint on both. Located in Dallas. 972-938-1905. www.empireequip.com. (CPBM)

1995 Harben 4016, good shape, new hose, \$8,200. 2008 laser jet, 4000 psi, demonstrator, \$12,000. 1988 Aqua Jet trailer mount, 2000 psi, 40 gpm, great shape, new paint, wheels, and axles w/brakes, \$9,800. 702-456-5388. (P4C5)

Myers Camel Jet with 368 original hours, always garaged, 30 gpm, 2000 psi, 500' of 3/4" hose. Was city owned. Located in the Chicago area. 815-693-9986. (CPBM)

JETTERS-TRUCK

1997 Sreco HV 2000 truck jet, 65 gpm, 2000 psi water pump, 1500 gallon aluminum water tank. Was a city owned unit. Located in Dallas. 972-938-1905. www.empireequip.com. (CPBM)

JETTERS-TRUCK

2006 Chevy TC6500 cab & chassis truck mounted jetting unit with JET EYE camera system, 3,000 psi @ 50 gpm, 1,000 gallons water, 600' hose, 500 cfm blower, debris tank and attachments. (Stock #13234) www.VacuumSalesInc.com, (888) VAC-UNIT (822-8648). (PBM)

Vactor water jet on a 1998 Ford F-800, Cummins diesel, 17,338 miles, automatic, 1000 gallon water tank. Needs water pump. This truck is like new. 972-938-1905. www.empireequip.com. (CPBM)

JET VACS

1990 Ford LTL-9000 with 1992 Guzzler Jet Vac Chassis: 3406-CAT (425 hp) engine, 396,579 miles, RTO #14613, 13-speed trans., John-Deere rear auxiliary engine, 1890 hours. Meyers D65-20VAD jet-pump, 2000 psi, 70 gpm. Sutorbilt blower Model #721-4500. 11-yd. debris tank, 1500 gallon stainless water tank, telescopic boom. Price \$34,900. Call 734-722-8922, M-F 8am-5pm EST. (C4)

2003 Sterling LT7501 cab & chassis with a Vac-Con Model VPD4216LHA/1300 16 cubic yd. debris body and a 1300 gallon water capacity combination vacuum jetter unit. This unit has been very well maintained. This unit is ready to be released even though his new unit is not complete. (Stock #4648C) www.VacuumSalesInc.com, (888) VAC-UNIT (822-8648). (PBM)

1999 Vac-Con, 12 cubic yard on International, factory rebuilt engine 2005, running complete, 63,436 miles, 80 gpm, 2000 psi, PD, Spicer trans., articulating hose reel. \$98,000. 610-692-9160. (CPBM)

Jack Doherty Supplies Inc. offers a full range of late model combo units and DOT industrial vacuum loaders. Call us @ 1-800-3DOHE NY. (CPBM)

1998 Vactor 2110 on a Freightliner FL80, 28,213 miles, 2-stage fan, 80 gpm, 2,000 psi pump off system accumulator. Was a city owned unit. Located in Dallas. 972-938-1905. www.empireequip.com. (CPBM)

1997 VacCon V390THA on a Ford, 3-stage fan, articulating hose reel, extendible boom, new white paint. Located in Dallas. 972-938-1905. www.empireequip.com. (CPBM)

JET VACS

1998 VacCon V312THA on a Ford LT8000, 3-stage fan, 65 gpm, 2000 psi pump, extendible boom, articulating hose reel, 12 yard debris tank, new paint. Was a city owned unit. Located in Dallas. 972-938-1905. www.empireequip.com. (CPBM)

1994 Vactor 2110/1995 International 2554, 10-yd. debris body, 1,000 gal. water, 8' telescopic boom, rotating hose reel, dual roller wind guide, hot shift PTO, fuel/water separator. Call Joe Donlon 312-208-6373. (P4)

Low hours, 1995 Vac-Con, 12-yd. debris, new water pump, newly rebuilt Roots blower, auto. trans., AC, tank vibrator, privately owned. \$65,000. 1-800-930-1123 or 954-981-2133. (CPBM)

2002 VacCon V390LHA on a Sterling L7501, articulating hose reel, 10' extendible boom, 3-stage fan, pump-off system, 65 gpm, 3000 psi pump, new paint, excellent condition. Located in Dallas. 972-938-1905. www.empireequip.com. (CPBM)

1992 Vactor 2100. 10-yd debris body, 80 gpm, 2,000 psi pump, single stage fan unit, low hours and miles, rebuilt by Vactor distributor. \$43,500. Call Joe Donlon 312-208-6373. (P4)

Vac-Con model VPD4209THA on a 1997 Ford, PD blower, 4200 cfm, articulating hose reel, extendible boom, new white paint. Was a city owned unit. In excellent condition. 972-938-1905. www.empireequip.com. (CPBM)

1999 Vactor 2100 on a Sterling chassis. Cat 3126 engine, Allison auto trans., 80 gpm @ 2500 psi, accumulator, debris body flush-out, 4' extend. boom, fold-down pipe rack. Call Joe Donlon 312-208-6373. (P4)

LEASE/FINANCING

BSM Financial Group is a nationally recognized finance company. We offer flexible payment schedules for all types of equipment new or used. Trucks, pumps, jettors, portable toilets, and software easily financed. We do first time start-ups, established businesses, and challenged credit. Call Brett at 877-524-7972 or email brett@bsmfinancialgroup.com. (PBM)

BUY IT - SELL IT - PLACE IT - www.pumper.com - AVAILABLE ANYTIME, ANYWHERE, ANY DAY

LEASE/FINANCING

North Star Commercial Credit: Commercial Loans for Trucks or Equipment. Flexible purchase programs to fit your budget. 21 yrs. in the industry. Contact **Tom Myers - 877-804-2274.** (CPBM)

EASY FINANCING! Specializing in new or used Trucks and Heavy Equipment. Start-ups welcome. Call IRON CAPITAL at 1-877-982-5111 or www.Iron-Capital.com. (P6)

Buying/Selling? We finance both. 100% financing, lowest payment. 6 months no payment. Trusted company who listens to all credit story. 888-798-3976. (P6)

MISCELLANEOUS

Top quality aerators at wholesale prices. We have replacement units for most name brands and also carry Linear Regenerative Rotary Vane pumps. Flagg Air, Gast, Thomas, FPZ, Secoh, Medo and more. Call a company that understands aerators and aeration systems. Septic Services Inc. 800-536-5564. (CPBM)

DISCOUNT ALUMINUM: ARE YOU PAYING TOO MUCH? 1,000 lb. minimum quantity. 5052/5454/5083/5086. .063 - 5.0" thick. All widths. Contact Jayson. 1-888-540-0066. (PBM)

FULL OPEN DUMP TANK, 2000 gallons, mounted on 1987 Ford F700, diesel, 5 speed, 310 CFM vac pump, big tool boxes, same owner since 1989. \$8,900. 405-235-8600. (P4)

PORTABLE RESTROOMS

Excess PolyPortable units (50+) in good to very good condition in North Georgia. \$175 each. E-mail toilets4sale@bellsouth.net. (PT5)

Gently used aqua Satellite Tuffways for sale. Approximately 4-5 years young, \$325 each. Also Satellite "wave" free standing sinks in good working condition, \$250 each. Call Sweet Pea Sewer & Septic in Missoula, Montana. 406-728-3533. (P4)

Over 600 PolyJohn units 1-2 years old. Starting at \$300 each. Minimum purchase of 26 units. 772-562-4604. kim@reliablepolyjohn.com. (PBM)

PORTABLE RESTROOMS

PolyPortables: 43 standard size, yellow w/white tops @ \$275 each unit, 4 yrs. old, nice shape. Durand, Michigan. 989-743-5055. (PT4)

Over 500 grey PolyJohn units next to new condition. Starting at \$200 each. Ready to earn you money! Located in SW Florida. Call 877-697-5954; erin@amberjack-inc.net. (PT5)

26 used PolyPortables. Fair condition. \$200 each. Located in SW Virginia. 540-382-2205. (P4)

40 Blue Taurus toilets for sale. Good condition. \$200 each. Call Chris or Bruce 770-439-3131. Atlanta. (P4)

Two-year-old portable toilets for sale. Units are in great condition. Must sell fast. \$150.00 non-negotiable. Assorted brands and colors available. Please call 561-202-2355. (P6)

300 tan PolyPortable units fair to good condition and jobsite ready. \$250 ea. OBO. Please call 863-655-2940 or email midflorida@areyoureadytopotty.com. (P4)

Used white fiberglass toilets for sale. Fair to good condition. Price range from \$55 to \$100. Call 757-566-1136. (PT5)

FOR SALE: Used portable toilets: Polysans, Hightechs models in Northern Ohio. \$100 to \$200 each. 419-466-1349. (PT5)

FOR SALE: PolyJohn, Poly-Portable tan units; plastic skids, excellent condition. Call for special pricing and shipping. Bob at 352-796-4540. (P6)

Portable Toilets: Poly constructed, molded seat, urinal, latching door. Handicap accessible units available. New and used. CCI/Brian Touey 805-896-3777. (PBM)

PORTABLE RESTROOM TANKS

Single or multiple compartment tanks. Choose mild, stainless, or galvanized steel. Capacities from 100 to 6000 gallons, any diameter. Parts and accessories to build your own and save money. 800-545-0174. www.tanksandpumps.com. (PBM)

PORTABLE RESTROOM TRAILERS

2006 - 820 Royale American restroom trailer (2) mens stalls, (3) urinals, (1) sink. (4) womens stalls w/baby changing station, (2) sinks. Touchless faucets, A/C, heat, hot water, CD player, skirting. Cost \$52,000. Asking \$39,000. 410-778-9145. (PT5)

Prestige Portable Restroom Trailer For Sale. Single axle trailer, men's and women's rooms, lights, vanity, pressure sensitive floor. \$15,000. Email for more info westernconnect2006@yahoo.com. (P4)

Restroom Trailer - Gold Series: 32', new and used. Women's - 5 stalls, 2 sinks. Men's - 2 stalls, 2 urinals, 2 sinks. CCI/Brian Touey 805-896-3777. (PBM)

New and used **RESTROOM TRAILERS** available immediately. 8 to 34 foot luxury trailers. Comforts of Home Services Inc. 877-382-2935. (PBM)

1999 ACSI 32' Advantage Restroom Trailer. 7 women's stalls, 3 men's stalls, 4 urinals. Pictures at www.arisrentals.com. (Aris 6000) \$30,000. 1-800-347-3778. (P4)

RESTROOM TRAILERS FOR SALE: New in 2007. Various sizes available. Ready for immediate use. 410-266-7812 or go to www.restroomtrailers.org for pictures and details. (P4)

Restroom Trailer - Platinum Series: 30', new and used. Women's - 4 stalls, 2 sinks. Men's - 2 stalls, 3 urinals, 2 sinks. CCI/Brian Touey 805-896-3777. (PBM)

PORTABLE RESTROOM TRUCKS

2004 Ford 550, 4WD, automatic, 130K, Abernethy tank, 700 waste, 300 water, excellent condition. View @ ablerentajon@charter.net or call 877-658-0982. (P7)

2002 GMC 3500 4x4 V8 gas/auto transmission, 142,000 miles, 12' flatbed w/liftgate, carries 6 units, 400/100 slide-in, Conde/Honda, can deliver. \$19,500. 920-655-7065. (PT5)

2005 GMC W5500 cabover, 17950 GVWR, 4 cyl. dsl., 190 hp, auto, 350 fresh/900 waste alum. tank. Masport pump, fold-down toilet carrier. 125K miles. \$43,500. Call 770-439-3131. (P5)

PORTABLE RESTROOM TRUCKS

2004 Chevy 1-ton, Duramax diesel, 373 axle, flatbed w/power liftgate, 2 storage boxes, 300 gal. waste & 120 gal. fresh, Honda electric start engine, new tires, 70,000, excellent cond., tank & truck. \$29,000. Michigan. 989-743-5055. (PT4)

Model 1100 (750/350) Crescent Rectangular Vacuum Tank up-fitted to a **2007 International 4100** (pre-emissions) chassis. Carry 8 units, Masport pump and traps. **Now Available!** View our website www.crescent-tank.com. **Crescent Tank Mfg. 585-657-4104.** (P4)

1999 Freightliner FL60 with a 6-speed manual and a 1000 waste, 250 mix, 250 water, stainless steel, portable toilet service unit. (Stock #2104V) www.VacuumSalesInc.com, **(888) VAC-UNIT (822-8648).** (PBM)

2002 4300 International, 25500 GVW, DT466, Allison, A/C, air brakes, 3-compartment tank (450/950/250), M-10 Moro pump, spot lights, 2 Burk water pumps for fill and spray down, restroom carrier. Pictures www.aacoinc.com/classified. Located Phoenix, AZ. \$40,000. 208-362-3193. (P4)

Portable Toilet Service Trucks: Reducing fleet, photos on request. Must sees: 2000 International 4700, 16' flatbed, 171,824 miles. 2004 International 4300, 2000 gallon Huber aluminum tank, 1500 waste/500 water, 116,475 miles. 2006 Freightliner M2-106, 22' flatbed will haul 12 Poly Portables, side lift gate and 100 gal. water tank. 2006 Freightliner M2-106, 47,000 miles, 1900 aluminum tank, 1400 waste/500 water. Call Anthony or Joey Boyett for prices at 251-946-3250. (PT4)

Model 1100 (750/350) Crescent Rectangular Vacuum Tank up-fitted to a **2007 GMC 5500** (pre-emissions) chassis. Carry 8 units, Masport pump and traps. **Now Available!** View our website www.crescent-tank.com. **Crescent Tank Mfg. 585-657-4104.** (P4)

1998 International 4700 with a 1,500 US gallon, 2-compartment (1100/400 split), carbon steel, portable toilet service unit. (Stock #8734C) www.VacuumSalesInc.com, **(888) VAC-UNIT (822-8648).** (PBM)

PORTABLE RESTROOM TRUCKS

Model 800 (550/250) Crescent Rectangular Vacuum Tank up-fitted to a **2008 Isuzu NPR-HD** chassis. Carry 6 units, reduce fuel costs and improve productivity. View our website www.crescent-tank.com. **Crescent Tank Mfg. 585-657-4104.** (P4)

2001 4700 International, 25500 GVW, engine DT466, 7-spd./OD, A/C, air brakes, 3-compartment tank (450/850/200), M-10 Moro vacuum pump, spot lights, pressurized water spray down & fill, restroom carrier. Pictures www.aacoinc.com/classified. Located Salt Lake City, \$38,000. 208-362-3193. (P4)

2004 GMC 5500 with a 1,000 US gallon, 2-compartment (700/300 split), carbon steel, portable toilet service unit. (Stock #0226V) www.VacuumSalesInc.com, **(888) VAC-UNIT (822-8648).** (PBM)

(2) 2005 335 Peterbilts, none CDL, 40,000 miles, like new, auto, air, 1500 waste/500 water with pressure washer, Progress tank, 2-unit carrier. \$68,000 each. 608-835-3459. (PBM)

1999 Isuzu FTR, 190 hp, 6 cyl. diesel, 25,900 GVW, new Allison auto with 2-yr. warranty, Jay's Inc. 1,300 gallon 800/500 split, National 190 cfm vac. pump, Burks DC-10 wash down pump, heated dump valve, heated bucket fill, heated water pump, 60' hose reel, 2-unit toilet carrier, and more. 123,800 miles. \$35,000. Call Dale 708-878-4391. Located in Illinois. (PBM)

1995 International 4700 Series w/auto trans., 280,500 miles, GVW 23,100, carbon tank by Coleman Co., 1200 cap. 275/850/75 hot water wash down system, 1000 psi w/reel dual toilet rack, \$11,000. 1992 GMC Topkick, 170 hp Cat diesel w/Allison auto trans, 251,000 miles, carbon tank by Coleman Co. 1,000 cap 400/600, electric pressure washer w/reel, dual toilet rack, \$5,500. Purchase both for \$15,500. Contact Bob Johnson 708-799-5533 Ext 3301. (P5)

2006 C5500 Chevrolet, miles in 40s with aluminum and steel tanks. Still under warranty. Slide-ins 600/250, \$9,000. Portable toilet transport trailers: 8, 10, 12, 14, 16, 20 haulers. New portable toilet trucks and new and used septic trucks. We stand behind everything we sell. Lane's Vacuum Tank Inc. 1-800-592-3308. (PBM)

PLACE YOUR AD ONLINE AT www.pumper.com - IT'S ALWAYS THERE TO MEET YOUR BUSY SCHEDULE

PORTABLE RESTROOM TRUCKS

2002 International Pumper Truck: 4700 series, DT466, automatic, air brakes, 1200 gallon waste, 300 gallon fresh water, Masport 75 pump. CCI/Brian Touey 805-896-3777. (PBM)

2007 Chevy C7500 cab & chassis with a new 1500 waste, 500 water, aluminum portable. Call for pricing. (Stock #13289) **www.VacuumSalesInc.com, (888) VAC-UNIT (822-8648).** (PBM)

POSITIONS AVAILABLE

Plumbing company in Florida seeking enthusiastic class B CDL tanker endorsement licensed pump/vac truck operator. Experience preferred. Medical, 401K, holidays, vacations. 1-800-930-1123 or 954-981-2133. (CPBM)

Looking to relocate to Sunny South Florida? Are you an experienced plumber or sewer and drain professional? Then you deserve to earn \$80K/year, \$5,200 bonus and a new truck and full benefits. Please call Don at 1-800-930-1123 or 954-981-2133. (CPBM)

PUMPS-SUBMERSIBLE

Wholesaler for Hydromatic, Zoeller, Myers, Liberty and ABS pumps. We also supply Grinder pumps and basins. Will help you size them. Septic Services Inc. 800-536-5564. (CPBM)

PUMPS-VACUUM

460 Challenger pump, approx. 7 years old, clockwise rotation. \$1,000 OBO. Day 810-560-3268; Evening 734-878-5228. (PBM)

Complete line of Moro, Conde and engine-driven, stand-alone pump systems, DC10 washdown pump. Call us for any of your vacuum truck parts from shut-off valves, primary and secondary valves, hoses, vacuum pumps and drive systems. Septic Services Inc. 800-536-5564. (CPBM)

New **Masport** pumps and genuine **Masport** components. Compare our price before you buy. W-K Machine & Supply Co. Call 1-800-633-8947. Distributor. (PBM)

PUMPS-VACUUM

Vacuum Pumps – New, used, or rebuilt. 30 to 900 cfm. All major brands; air, water, or fan cooled. Rebuild specialists - rebuilt PB, M3, M10, and others available. 800-545-0174. **www.tanksandpumps.com.** (PBM)

Need a vacuum pump for your portable pumper? Try our new 30 cfm, 12 volt system. Less noise, no fuel. Automatic oiling, cheaper than a gas engine. 800-545-0174. **www.tanksandpumps.com.** (PBM)

SAFETY EQUIPMENT

Large quantity of Tyvek, Saranex and CPF3 suits, slush boots. Rubber, leather and nitrile gloves. Fittings and tank entry equipment. Retail value over \$300,000. Sale price \$150,000 OBO. Will separate. 716-284-1260 or 716-510-2482. (CP4)

SEPTIC TRUCKS

2001 Sterling septic truck, brand new 3500 gallon tank and pump, new tires, C12 Cat engine, works great, closing septic division. A steal at \$49,000. 702-456-5388. (P4C5)

2004 International 4300 with 2500 gal. tank, 4 heated valves, TSI 500 pump, excellent condition, 125,000 miles. \$49,900. 607-746-3003. (P5)

1994 Ford ITRA 9000, 52K GVW, tandem with locking differential, engine brake, new clutch, good rubber and brakes, 400 cfm liquid cooled Masport pump, 2600 gallon tank, both approx. 2 years old. Runs great. Colorado. \$37,000. 719-748-3721. (P5)

2005 Huber Dominator 4200 gal., hoist, HYD open rear door. Water jet system, 500' reel. Truck is 1986 Peterbilt 359 triaxle. Full frame up restoration. Absolutely immaculate, call for full specs. 978-423-7538. (P6)

1999 Peterbilt, 435 hp Cat, 13 spd., with new 3400 gallon vacuum tank, new Moro M10 pump, new paint and tires, exc. shape. \$65,000 OBO. 309-224-8772. (CP7)

1990 International septic truck. DT 230 hp engine. 2600 gal. tank. Fruitland pump. New paint and tires. Call for more info. \$16,000 neg. 1-920-743-5099. (P6)

SEPTIC TRUCKS

2003 International 4400 DT466, 2500 gal. aluminum tank, 350 cfm pump, 65,000 miles. Was Jay's Show Truck. Plus 250' Tiger flex hose. Excellent condition. \$54,500 OBO. Please call Jim @ 312-543-0570. (CPT6)

1993 International FH900 PresVac PV750. Runs great. Steel tank. Picture can be emailed upon request. Call 1-203-838-7000, ask for Bill or Dave. (CP4)

1993 Int. Model 9400, 360 hp Cummins, 386,000 miles, 3600 gal. tank, 450 cfm Wallenstein pump, 4' side intake/discharge, rear 6' intake/discharge. Truck, tank and pump in excellent condition. \$30,000 Firm. 717-354-5867. New Holland, PA. (P4)

1977 Ford F700 septic pump truck. 361 motor, 5-speed with 1500 gallon Lely tank with good 5-year-old Masport vacuum pump PTO driven and 100 feet of hose. \$2,500. 573-276-5264. (P4)

1999 Vactor 2115, 1999 International, 15CF debris body, Roots PD vac. blower, 8' hydraulic boom w/joystick, hydraulic rotating hose reel, 600'x1" sewer jet hose, 80 gpm @ 2000 psi water jet system. Call for full specs and details. 305-251-8104. (P4)

2001 Mack RD686ST heavy spec. with a 3200 gallon **stainless steel** vacuum tank, large tool boxes, NVE 466 Challenger pumps. Excellent truck; very well maintained by one operator. (Stock #7665V) **www.VacuumSalesInc.com, (888) VAC-UNIT (822-8648).** (PBM)

2003 Sterling 9513. 430 Mercedes power. Aluminum rims, fuel tank and tool boxes. Custom built unit. 4000 gallon steel vacuum tank. 750 water cooled vacuum pump. 35,000 miles. Mint condition. Always garaged. \$65,000. Call 781-585-1725. (CP4)

2001 Freightliner, 3300 gallon, Mec 8000. Looks and runs excellent. Washed daily and garage kept. \$49,900. 231-228-7499. (P5)

2001 Mack RD686ST heavy spec. with a 3200 gallon **stainless steel** vacuum tank, large tool boxes, NVE 466 Challenger pumps. Excellent truck; very well maintained by one operator. (Stock #7948V) **www.VacuumSalesInc.com, (888) VAC-UNIT (822-8648).** (PBM)

SEPTIC TRUCKS

2004 Peterbilt Model 330, CAT motor, air ride susp., fully loaded, 3600 gal. Transway tank. Truck is like new, 50K miles, red. Asking \$82,000. 978-692-3085. (PBM)

New Presvac 4000 gallon, aluminum polished shell with primary shutoff, 20" top & rear cleanout, 4" intake, 6" discharge. Diamond plate hose trays with full length paint protection. (2) full baffles. (Stock #13290) **www.VacuumSalesInc.com, (888) VAC-UNIT (822-8648).** (PBM)

1992 Ford L9000, AC, 3700 gallon tank. Moro M-9 pump, hoisted unit, full opening rear. Good truck for washbay cleaning and septic tanks. \$27,000. 913-631-5201. (P4C5)

1984 International S2300 vacuum pump truck, 2600 gallon tank with Moro M10 pump. Good starter or backup truck. \$19,500 OBO. 229-834-4775. (P4)

2000 Pioneer 6300 gallon, carbon steel, vacuum tank trailer with primary & secondary. Hose trays on both sides and a hutch suspension. Nice trailer. (Stock #0224) **www.VacuumSalesInc.com, (888) VAC-UNIT (822-8648).** (PBM)

1997 Peterbilt Model 357, CAT 3306 motor, Fuller 8-speed trans., 4200 gal. Transway tank, 800 Transway pump, 220K miles, red. Excellent condition, ready to work. \$55,000. 978-692-3085. (PBM)

1994 Freightliner, 3176 Cat engine, 10-speed, 260 Juroop vacuum pump, two-year-old 3,500 gallon tank, heated valves, \$42,000 OBO. Call for pictures. 920-743-8801. (P4)

2001 Intl. DT-466, 7-spd. tandem, new 3600 gal. tank, Masport 350 cfm vacuum pump, 237,000 miles, \$49,000. 2000 Intl., DT-466, auto., new 2300 gal. tank, 350 cfm Masport pump, 147,000 miles, \$44,000. Other new & used toilet & septic trucks available. Everything we sell has warranty. Lane's Vacuum Tank Inc. 1-800-592-3308. (PBM)

1997 Mack pumper, 3800 gal. steel tank, 450,000 miles. Asking \$42,500. Call 1-716-432-2885. (P4)

1994 FL 70 Freightliner, 1620 gal. full door dump, new Masport water cooled pump, new tires, new brakes, 6" air dump, 125-gal. wash-down tank. Excellent condition. One owner. 605-286-3359. (P4)

SEPTIC TRUCKS

Pre-owned 3,500 gallon, carbon steel tank with primary and secondary full length trays, top and rear manholes. Great thickness test report. (Stock #VS102V) **www.VacuumSalesInc.com, (888) VAC-UNIT (822-8648).** (PBM)

2008 new Acro trailer, 7,000 gallon double conical, 12" drop to center, aluminum trailer. On our lot and ready to go. (Stock #13273B) **www.VacuumSalesInc.com, (888) VAC-UNIT (822-8648).** (PBM)

Need a tank and truck, any size, any make truck? Let us help you get the best deal. Custom built to your specs. For information and a price quote call 800-545-0174. **www.tanksandpumps.com.** (PBM)

2008 Peterbilt 340s **loaded with every option except with automatics**, with a new Presvac 3600 gal., aluminum vacuum tank units with Masport HXL400WV water cooled pumps. (4) 2009 Models coming in April & May. (Stock #13297 C, D & E). **www.VacuumSalesInc.com, (888) VAC-UNIT (822-8648).** (PBM)

SHOWER TRAILER

Shower Trailer - Gold Series: 32', new and used. Men and women sides each have 3 private shower stalls with changing area, 1 restroom stall, 1 sink. CCI/Brian Touey 805-896-3777. (PBM)

SLIDE-IN UNITS

Start up/Back up — Complete package; '07 slide-in unit (250/200), '07 Dodge 2500 4x4. Slide-in unit has a Masport pump with a Honda electric start 5 hp engine. The '07 Dodge has a HO Cummins diesel engine with a 6-speed transmission. See pictures on website **www.crescent-tank.com. Crescent Tank Mfg.** 585-657-4104. (P4)

SLUDGE APPLICATORS

1987 I.M.E. Super/Jector 3500 gal. vac/pressure tank, 250 hrs. on 3208 Cat re-man. motor. Pearson PB8 vac pump, four-knife shank, tires 66x43.00/25 at about 60%. Unit in good condition. \$38,500 OBO. Day: 810-560-3268; Evening: 734-878-5228. (PBM)

SLUDGE APPLICATORS

For Sale: 2001 AgChem 3104 Terragator NMS liquid tank. Must sell. Phone 204-526-2040. (P4)

Agco Terra Model #2004 Gator sludge applicator. 4 hours on rebuilt engine, 4 newer tires. Located in Ohio. Call 412-403-4027. (P5)

1995 004 Terra Gator, 8.3 Cummins, 3,000 hours on motor, 6-speed Funk power shift transmission, 5-shank DMI chisel plow. \$50,000 OBO. 262-677-9067. (P5)

TANKS

WANTED: A complete good condition used truck mounted vacuum pressure 23-2500 gallon tank with PTO pump. In western US. 541-280-4995. (P4)

New/unused 462 BBL Dragon Products round bottom Frac tank, epoxy lined. \$25,000. Contact Tim 858-622-0545; cell 619-977-8791. (P4)

Used 3050 gal. vacuum tank 72" x 16", primary/secondary shutoffs, hose trays, 20" top/rear manways, 3/3" site glass, 4" air valve with rebuilt DRUM S440 vac, pump 400 cfm. \$5,900 OBO. Pictures 402-371-7024. (P6)

New 3400 gallon tank, never used, 36" manway bottom, 20" manway top, 3" intake, 4" dump, hose trays. \$10,000. Delivery available. Other tanks available. 800-721-2774 or 239-656-2774. (P4)

5000 gal. ISO TANKS, steel, 8'x8'x20", single compt., exterior rings, 2" discharge valve, internal heat coils, 1/4" steel plate, mfg. GTAX, for 20' or 40' container chassis or flats. For mobile, stationary or vacuum use. Excellent condition. 3 units. \$3,750 each. ATLANTIC. 904-387-3276. (P4)

New 5000 gal. tank w/primary, 2-21" manways top, 36" bottom, 4" intake, 6" discharge w/valves. Painted white. \$15,000. Delivery available. 800-721-2774 or 239-656-2774. (P4)

Vacuum tanks, 100 to 6000 gallons. All options available; hatches, primary, secondary, valves, catwalks, ladders, etc. Every-thing needed to build your own septic truck. Choose mild, stainless, or galvanized steel. Ask about full open doors. 800-545-0174. www.tanksandpumps.com. (PBM)

TANK TRAILER

New Presvac 4000 gallon, aluminum polished shell with primary shutoff, 20" top & rear cleanout, 4" intake, 6" discharge. Diamond plate hose trays with full length paint protection. (2) full baffles. (Stock #13290) www.VacuumSalesInc.com, (888) VAC-UNIT (822-8648). (PBM)

New Presvac 5,500 gallon, carbon steel, DOT, vacuum tank trailer with pump & engine package. (Stock #13325) www.VacuumSalesInc.com, (888) VAC-UNIT (822-8648). (PBM)

1990 Presvac 5000 gallon stainless steel, DOT with pump engine. (Stock #5008V) www.VacuumSalesInc.com, (888) VAC-UNIT (822-8648). (PBM)

2000 Pioneer 6300 gallon, carbon steel, vacuum tank trailer with primary & secondary. Hose trays on both sides and a hutch suspension. Nice trailer. (Stock #0224V) www.VacuumSalesInc.com, (888) VAC-UNIT (822-8648). (PBM)

2008 new Acro trailer, 7,000 gallon double conical, 12" drop to center, aluminum trailer. On our lot and ready to go. (Stock #13273 A&B) www.VacuumSalesInc.com, (888) VAC-UNIT (822-8648). (PBM)

Pre-owned 3500 gallon carbon steel tank with primary and secondary full length trays, top and rear manholes. Great thickness test report. (Stock #VS102V) www.VacuumSalesInc.com, (888) VAC-UNIT (822-8648). (PBM)

1990 Presvac 5,000, stainless steel DOT certified vacuum tank trailer with PV750 pump, Deutz diesel engine package. Mirror type polish finish tank with trim paint black. Less than the price of a new one with a great thickness report. (Stock #5008) www.VacuumSalesInc.com, (888) VAC-UNIT (822-8648). (PBM)

TOOLS

T&T Tools: Probes, Hooks. Probes feature steel shafts with threaded and hardened tips. The insulated **Mighty Probe™** tested to 50,000 volts. **Top Poppers™** open manhole covers easily. Free catalog. www.TandTtools.com. Phone 800-521-6893. (CPBM)

TOOLS

Crust Busters - Portable, lightweight machine guaranteed to mix up septic tanks and grease traps! Save time and money! www.crustbusters.com, 1-888-878-2296. (PBM)

TOYS

Septic pumper and vacuum die-cast toy trucks in your choice of colors and logos. Several cabs available. Call 877-450-2100 or write to Granite State Collectibles, PO Box 440, New Ipswich, NH 03071. (PBM)

TRAILERS VACUUM/TANKER

1993 Presvac 5,800 gallon steel vacuum tank trailer. Asking \$15,500. Call 1-716-432-2885. (P4)

5000 gal. STEEL vacuum tank trailer MC330, 1978 STRICK, 1-compt., rear 36" manways, 2-top dome lids, full chassis, tandem axles, excellent, 11R:22:5 radial tires, air brakes, 2-spd. landing gears, side walkways, clean, excellent condition, for your vac pump. \$11,500. ATLANTIC. 904-387-3276. (P4)

1500 gal. STEEL vacuum tank, 1995 Badger, 2-compt. w/21" manways, 3" discharge valves, bottom mounting rails, length 9', tank 3/8" welded steel, dome ends, w/Masport vacuum pump mod. H75W, PTO drive, overall excellent condition. \$7,950. ATLANTIC. 904-387-3276. (P4)

TRUCKS\ DELIVERY

1985 Mack DM600, 6-spd, cab replaced, 4000 gallon tank, 3 valves, Moro A-C4 pump, 1-15,000 lb. Bethlehem Mfg. mountrail bed, 18' bed, 10' boom, double post on back. 252-491-2321. (P6)

TV INSPECTION

Must see! 2 X Envirosight camera systems 2005 pan-and-tilt camera 4X digital zoom Rovver 100 steerable crawler 4-12" automatic motorized reel PCU with monitor, text generator, footage counter. Portable or truck installation. Serviced and inspected Envirosight. 613-227-8659. (CP4)

TV INSPECTION

2001 Aries Saturn 3 Pipeline Video Inspection System mounted in an enclosed trailer. VC-3000 video capture system, TR-2000 camera transporter 6" to 30", 1200' reel/winch with level wind, PE-1111 pan & tilt camera with aux. lights. Misc. skids, poles, tiger tales, emergency repair kit. Unit is ready for work. PRICED TO SELL \$9,999. 715-967-2838 or 1-866-203-2033. (P5)

1998 Cues TV grout unit, 34,880 miles, color camera, diesel, generator. 972-938-1905. www.empireequip.com. (CPBM)

Aries TV sewer inspection system, pan & tilt, on tracks, color, in 1993 Ford E350 box van, roof air, 7.3 diesel, 80K miles, Martin diesel generator 7.5 kw, TV, VCR, 3 units available. Call or email for more info and pictures. We can ship to any location. Very nice City owned trucks. Asking \$29,950 ea. Call 573-374-8785 or email elitemotors@charter.net. (CP4)

2001 Chevy Cube Van, white with 48,000 miles, with roof top AC, Aries pan/tilt camera with two tractors, 550' of cable, DVD or VHS. Call 641-660-6991 or 641-673-9377. (P5C6)

VACUUM LOADERS

1997 Peterbilt 379 heavy spec with a 3200 gallon carbon steel DOT certified, Cusco master vac wet/dry industrial vacuum loader with dual baghouse, PD blower, rotary vane vacuum pump (no boom), 8 top fitting on rear door. Full open rear door dump unit. Very clean. (Stock #1499V) www.VacuumSalesInc.com, (888) VAC-UNIT (822-8648). (PBM)

1989 series 2000 Vector vacuum box, excellent condition, auger from bag house, hydraulic boom, photos available upon request. \$5,000. 204-633-4879. (CP5)

2008 Sterling LT9500 tri-axle with a new Presvac, Powervac 3800, 3,250 gallon US, DOT, wet/dry industrial, vacuum tank loader. (Stock #13294B) www.VacuumSalesInc.com, (888) VAC-UNIT (822-8648). (PBM)

1995 Vector/Guzzler model 1645, CAT diesel powered. Truck bought October 2008 and not used. Previously bought in 2007 and used for one six month project. Truck is in excellent working condition. Call for more details. 803-783-3314. (P5)

VACUUM LOADERS

1999 International heavy spec with Guzzler ace wet/dry industrial vacuum loader. 8" top load boom truck is in excellent condition. Blower was reconditioned approximately one year ago. (Stock #7390V) www.VacuumSalesInc.com, (888) VAC-UNIT (822-8648). (PBM)

2003 Guzzler/Sterling chassis. 147,000 chassis miles, 335/1250 CAT C-10, 10 speed Eaton, 27" Hibon 285. 64K GVW. Good shape. 414-349-3225. (P4)

VACUUM TRUCKS

1982 GMC Brigadier Hi-Vac Vacuum Truck, Cat 3208 (175 hp) engine, Fuller RT-610 trans., 10,107 miles, 664 engine hours. Detroit diesel 371 rear-engine, 2,528 hours. Blower M#H-46-5518-46L3 installed new Nov., 1997. 2500 cfm @3600 rpm, 15" vacuum. Price \$19,995. Call 734-722-8922, M-F 8am-5pm EST. (C4)

VANES

Dura Comp 535, high-quality non asbestos vacuum pump vanes. Good to 400°F. Buy factory direct and save. Same day shipment on most models. Juroop, Battioni, Moro, Masport, Fruitland, Demag. Long lasting Dura-Comp 535 pump vanes carry a "Money-back" guarantee. Call us today. Powerflo Products 800-758-4788 or 562-997-0720. (PBM)

American Industrial Components: Our vanes are manufactured from the highest quality laminated materials available and are fabricated to exact tolerances and specifications. Please see our ad in this issue. 800-272-7557. (PBM)

WANTED

WANTED: 2505 Terra Gator Tool Bar, 4 or 5 shank, straight bar, model P-16 Case IH reset style. Ph: Ron @ 204-745-8310. (CPT4)

Water jetting equipment. We rent, sell and repair water blasters. Visit us at: www.waterjettingequipment.com or phone 714-259-7700. (CPBM)

WATERBLASTING

Wanted to Buy: Vector 2100s and late model Guzzlers. Cash. Phone 800-336-4369. (CPBM)

PLACE YOUR AD ONLINE AT www.pumper.com - IT'S ALWAYS THERE TO MEET YOUR BUSY SCHEDULE

ABERNETHY

WELDING & REPAIR INC.

Vale, North Carolina 28168

Call Bill Abernethy at **1.800.545.0324**

Fax: 828.324.2401 • E-mail: abernethyinc@charterinternet.com

authorized distributor for:



www.abernethywelding.com

**2008's
Are Here!**

- International
- Ford • GM

2008 PETERBILT

2500 gal. tank, 2 with 6-spd.

2008 KENWORTH T300

2500 gal. tank, 6-spd., 260 hp

(2) 2008 INTERNATIONAL 4400

2500 gal. tank, (1) 6-spd. transmission & (1) auto transmission

NEW PORTABLE TOILET UNITS:

(2) 2008 INTERNATIONAL 4300s

1500 gal. portable toilet service units, auto transmission

2008 5500 CHEVROLET

1000 gal. 700 waste / 300 fresh, 2 Wheel Drive & 4 Wheel Drive available

2008 KENWORTH

1500 gal. portable toilet service unit, auto transmission

2008 PETERBILT

1500 gal. portable toilet service unit, auto transmission

WE WILL CUSTOM BUILD YOUR TANK UP TO 5000 GALLONS!

600-1500 Gallon Portable Toilet Trucks: Our Truck or Yours

SEVERAL GOOD, OLDER TRUCKS TO CHOOSE FROM:

- 1995 International
2500 gal. tank
- 1997 Volvo
4000 gal. tank
- 1998 Volvo
4000 gal. tank
- 1997 Ford
2500 gal. tank

PORTABLE TOILET UNITS:

- 1999 Freightliner
1500 gal.
- 1999 Sterling
1500 gal.
- 1991 4700 International
1400 gal. tank

**MANY OTHER
UNITS IN STOCK!**

**CALL FOR
UPDATE**



2008 International 4400E Series, 260 hp diesel DT 466 engine, 6-spd. trans. and world class auto, air brakes, 33,000 GVW, air conditioned, 2500 gal. tank, Masport HXL400 pump. **IMMEDIATE DELIVERY!** Also, 2500 and 3500 gal. tanks **READY FOR IMMEDIATE DELIVERY.**



2008 International 4300, 220 hp DT466, Allison auto. trans., air brakes, 25,999 GVW, air conditioned, total tank capacity: 1100 waste/400 fresh, Masport HXL75V pump. **IMMEDIATE DELIVERY!** Also, 1500 gal. tanks **READY FOR IMMEDIATE DELIVERY.**

Check with us on financing for the purchase of a new truck!

COMPLETE PARTS AND IN-HOUSE SERVICE FOR:

AIC Vanes • Moro • Battioni • Jurop • Masport • Fruitland • NVE • Powerflo • Plus many other brands

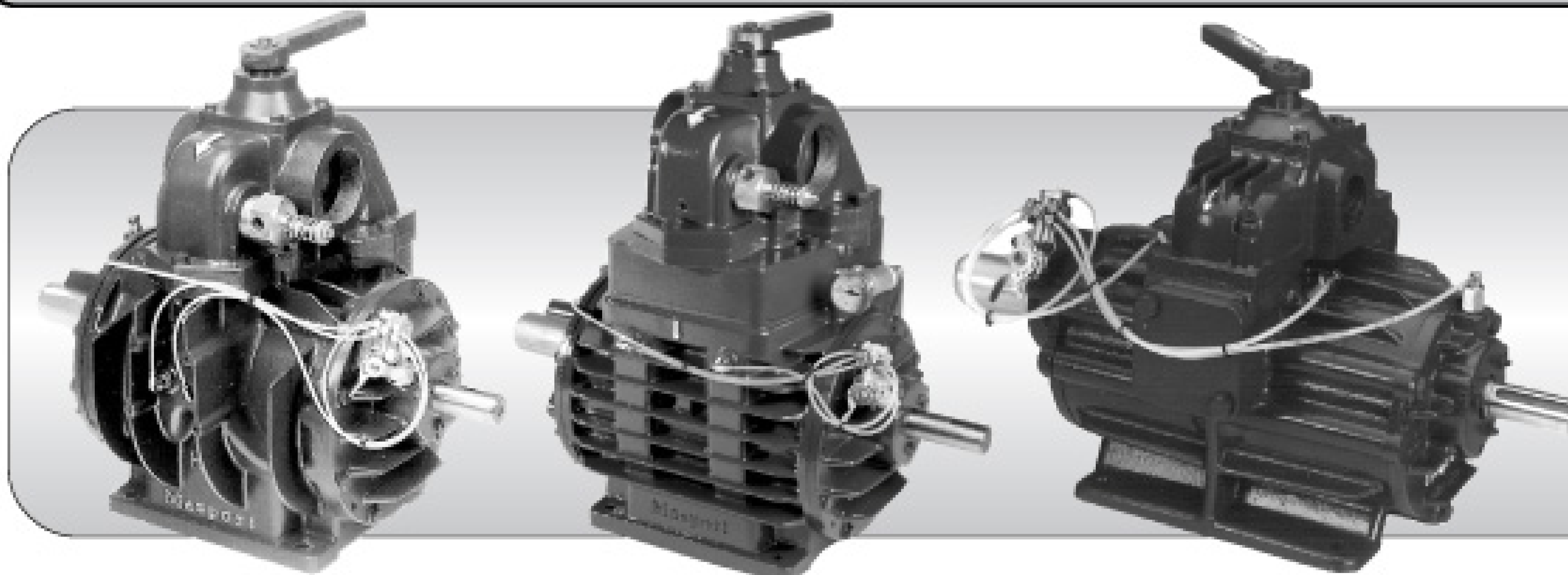

**Complete Line of
Masport Pumps
Available**

Immediate Delivery

OVERNIGHT DELIVERY ON PARTS • SAME DAY SHIPMENT ON PUMPS

WE SPECIALIZE IN PORTABLE SANITATION AND SEPTIC PUMPING EQUIPMENT

Marketplace Advertising

NEED GLOVES?

- 14" Gauntlet
- Plastic Coated
- Sandpaper Finish Grip
- Jersey Liner
- One Size Fits All

\$35 PER DOZEN \$189 FOR 8 DOZEN

TO ORDER, SEND A CHECK / MONEY ORDER OR CALL US TOLL FREE! Make checks payable to: ADVANCE GLOVE CO. Please include UPS shipping address.

Major Credit Cards Accepted!

ADVANCE GLOVE CO.
80, BOX 149 • LEMMON, MI 48449
300-4951 7-800-323-1223

SEPTIC ODOR PROBLEM?

ODORHOG™ Charcoal Activated Vent Pipe Filters Remove Sewer & Septic Odors from Plumbing Vents



ODORHOG™ Filters Come in 5 Standard Sizes or Any Custom Size You Specify
SAME DAY SHIPPING & PRIVATE LABELING AVAILABLE

A&M BIO-FILTER, LP
1.800.963.6746

www.odorhog.com

30% OFF FOR ALL ORDERS OVER \$2000

Mobile Dewatering Service

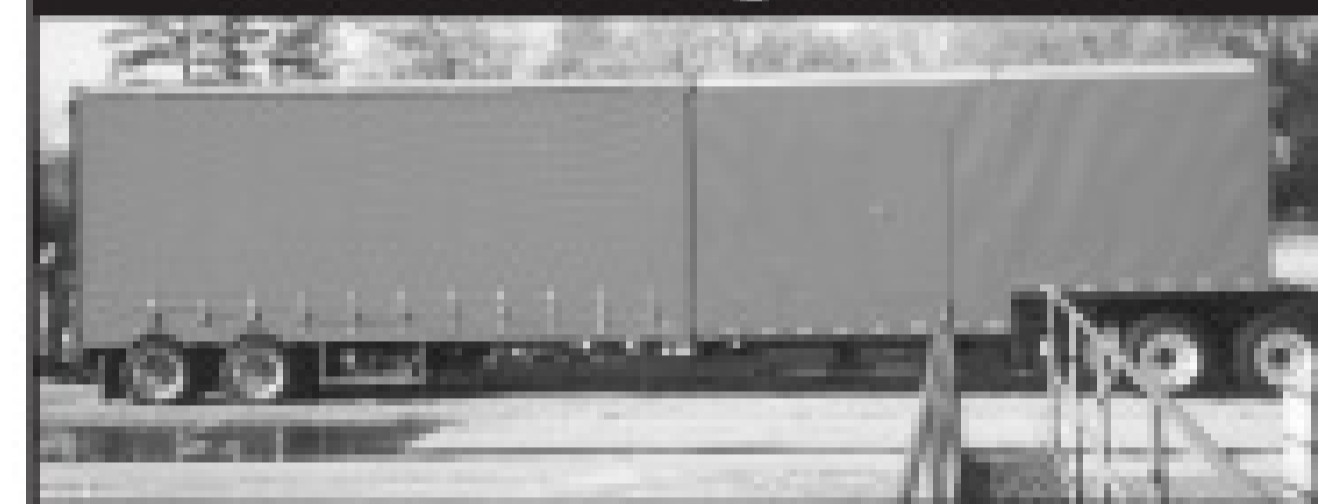

Municipal & Industrial Sludge Digesters, Lagoons, Ponds, etc.

- Double Belt Filter Press
- Up to 25% Drier Cake
- Professionally Staffed
- US & Canada

Fluid Technology, Inc.

P.O. Box 937, Oxford, OH 45056
Phone: 513-981-7808
E-mail: sales@fluidtechinc.net
Web site: www.fluidtechinc.net

Aluminum Vacuum Tanks

ALUMATANK

progress tank.com

PORTAVAC

Septic & Restroom Service

DISCOUNT ALUMINUM

SHEET, COIL, PLATE

3003/5052/
5454/5083/5086
AND MORE

20 MILLION POUND INVENTORY

ARE YOU PAYING TOO MUCH?

1-888-540-0066
ASK FOR JAYSON

FAX:
440-286-2229

E-MAIL:
captaluminum@msn.com

Refrigerator MAGNETS

500 Minimum -
Call for pricing

43¢ EACH!



Actual Size: 4" x 1-3/4"

2-color Imprint - Quantity Discounts

CONFINED SPACE ENTRY PACKAGE
ONLY \$3,295

The best package on the market includes:

- 4-Gas Air Monitor (3 Year Sensor Warranty)
- 7' Tripod
- 3-Way Fall Protection
- Work Winch
- Full Body Harness



Add a Blower with 15' of duct for only \$ 300!

Other Equipment Available

- Sewer Maintenance Tools
- Magnetic Lid Lifters
- Camera Systems
- Smoke & Dye Testing Items
- Blowers / Ventilators
- Vacuum Pumps and Acc.
- Aluminum Folding Ladders
- PPE
- High Pressure Water Jetters

MTECH 800.362.0240

www.mtechcompany.com

EASILY MOVE RESTROOMS

- ✓ Aluminum Frame
- ✓ Ships UPS
- ✓ Carry ADA's
- ✓ Models starting at \$380



Available with 2, 4, 6 or even 8 wheels and your choice of air or solid foam tires.

Super Mongo Mover®

DA
Deal Assoc. Inc.

www.dealassoc.com

866.599.3325

90 DAY JETTER TRIAL

Plumbers - Let us improve your bottom line



13HP 4000 PSI \$1,949

Free Freight

COMPLETE DETAILS AT

www.amazingmachinery.com

1-800-504-7435

WWW.ROOTERMAN.COM



Franchises available with low, flat fee
New concept. Call 1-800-700-8062.

FRANCHISE PACKAGE \$7,950.

"You're going to WORK, not WAR!"

ARE YOU STILL USING A HOOK OR PICK AXE TO REMOVE SEPTIC TANK COVERS?
NOW THERE IS A BETTER WAY!



Call for a FREE 30 Day Trial

phone: 866.926.5438
fax: 866.271.9057
email: info@BigsEasyLift.com
www.BigsEasyLift.com

BIGS EASY LIFT

Eliminate back injuries with BigsEasyLift

PADLOCKS

- Your Padlocks
- Your Key Number
- Any Quantity
- Best Prices

PUMP

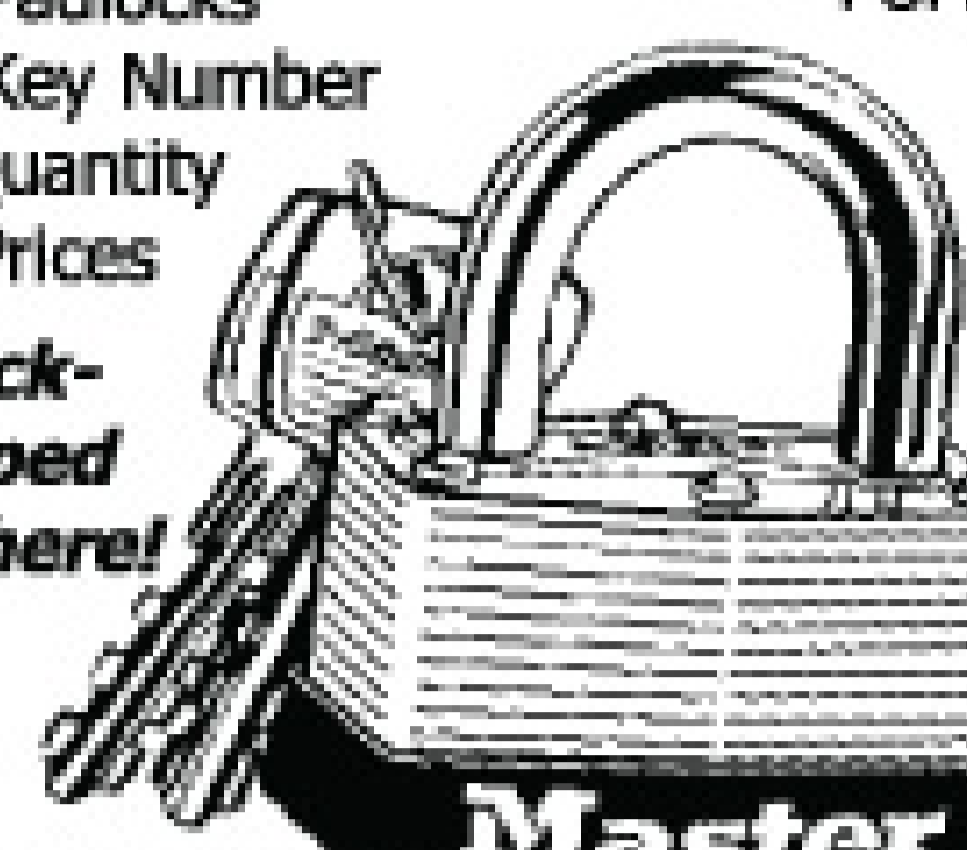

Quick-Shipped Anywhere!

Master

SERVING THE PORTABLE SANITATION INDUSTRY FOR 14 YEARS—WE'RE THE BETTER WAY TO BUY PADLOCKS™

Call For FREE CATALOG or Instant Quote!

LockMasters
1-800-461-0620
www.lockmastersusa.com

sales@lockmastersusa.com • Fax (850) 914-9754



- GPS Vehicle Tracking
- GPS Route Statusing
- Automatic Notifications
- Driver Scheduling
- Paperless Time Cards
- Payroll Interface
- Real-Time Mapping
- Productivity Reports

...and much more

800-928-7688
www.dispatchgps.com

PIT HOG PUMPS WASTE

LWT manufactures manned and remote controlled lagoon dredges and pumps. Rental dredges also available.



LWT LIQUID WASTE TECHNOLOGY.

Box 250, 422 Main St., Somerset, WI 54025
www.lwtpithog.com / 1-800-243-1406

1-800-333-9274
www.watercannon.com

Pressure Washers

HONDA @ 2700PSI \$377
HONDA @ 3000PSI \$416
HONDA @ 4000PSI \$859



Honda Engines

5Hp	GC	\$199
6.5Hp	GX	\$349
8Hp	GX	\$459
9Hp	GX	\$489
13Hp	GX	\$589
18Hp	GX	\$1,099

BEST Sellers ALWAYS on Sale

5.6GPM @ 4000PSI	\$399
8.0GPM @ 3500PSI	\$499
7.0GPM @ 5000PSI	\$599



Call For Free Quotation.
We Also Stock Pumps With Left Hand Drive, Tapered Shaft, Car Wash Duty, 318 Stainless Steel and Unique Applications
1-800-964-9274

Water Cannon - 5 Offices Nationwide, Repair Parts Specialists Since 1981



ASHLAND PolyTraps

Grease, Oil, Hair and Lint Traps and Interceptors

- NO Rust or Corrosion
- Lightweight
- Very Cost Effective
- Sizes up to 560 Gallons
- Made in the U.S.A.!

LIFETIME WARRANTY!

Certified by U.P.C., IAPMO and P.D.I.

800-541-8004

PolyTraps@Amplex.net
www.ashlandpolytrap.com

TrakMats™

Ground Cover Mats

- * Tough, Lightweight
- * Cleats for traction
- * Light color prevents burnt grass
- * Hand cutouts for lifting



800-762-8267

SVE Sales, Inc. www.trakmats.com
Charlotte, NC 28216 email: sales@trakmats.com

WATER JETS FOR RENT



- Units from 4,000 to 40,000 psi, including convertibles
- 60-600 hp, diesel or electric
- Rent, buy or lease
- Branches in MI, TX, NJ, CA, LA

NLB Corp. 1-877-NLB-7996
www.nlbcorp.com

Kwik-Lokk

Vacuum Truck Couplers and Hose.

www.kwik-lokk.com
(814) 899-3644



1.800.257.7222

Marketplace

advertising

Now Available In 4-Color

Deadlines:
Pumper: 10th of the month*
*PRECEEDING ISSUE DATE

Pumper

Pumper Marketplace gives you nationwide exposure to thousands of industry professionals. Layout and design is included **FREE**, and we can fax or e-mail you a proof for final approval!

Choose a size that works best for you!

Size A: \$309^{00*} 1.875" w x 4.875" h <small>This size is great for 2 photos!</small>	Size B: \$209^{00*} 1.875" w x 3.2" h <small>Perfect size for one photo!</small>	Size C: \$109^{00*} 1.875" w x 1.5" h <small>A great value!</small>
--	---	--

*Black and white prices, call for 4-color pricing.

[Send ad materials and payment to: COLE PUBLISHING INC. • P.O. BOX 220 • THREE LAKES, WI 54562]

Waterblaster Rentals

Houston, Texas



Boatman Industries

1K to 50K psi
60 hp to 1000 hp
Waterblasters & Accessories
Used Equipment Sales
713-641-6006
www.boatmanind.com

Michigan Vacuum Trucks

Custom Built Tanks to Your Specs!

P.O. Box 234 Carleton, MI 48117



Custom Built Vacuum Trucks to Meet Your Business Needs

All trucks are equipped with Masport Pumps
1/4" Steel Construction

Totaled Your Truck?

Rent a Vacuum Unit while your truck gets fixed

THANK YOU

U.S. Ecology Idaho for purchasing a 4000 gallon vacuum unit from Michigan Vacuum Trucks.

Masport
NVE

Specializing in
New Vacuum Trucks,
Used Vacuum Trucks,
Toilet Trailers & Slide in Units.

Purchase a New Portable Toilet Truck for only \$45,000*

In Progress: **2007 Freightliner M-2**
250 HP Cat, 6-speed manual, 18,000 miles full factory warranty, NEW 2500 gallon vacuum body Masport HXL400WV vacuum pump, 2 manways, 3 sight eyes, 4" discharge, 3" inlet, painted to suit. **\$67,000**
Call Terry at Michigan Vacuum Trucks 734-777-0390

We Can Also Mount a Custom Designed Vacuum Tank on Your Chassis!

Call for a FREE quote today!

734.777.0390

*Prices are subject to change.

"Duel Power Lid"

Plugs, Lids & Adaptor Rings

Sizes Available: 18", 24",
30" & 36"



Thanks for visiting us!



Fergus Power Products
Providing "Environmental Products"

The Company who maintains a pulse on the environment!

Toll Free 1-800-243-7584

E-mail fpproducts@prtcl.com

Come In
We're

OPEN

www.pumper.com

Celebrating 30 YEARS in business

Coagulants and Flocculants for Septic, Grease, Municipalities and Industry

- Dewatering polymers for all dewatering equipment
- All forms: Dry and Emulsion
- Variety of packaging sizes to meet customer needs
- Both East & West coast shipping points
- Expert technical staff
- Specific solutions for our customers

Save Money
Save Time
Save Polymer

Call Toll-free: 877.771.6041

Aqua Ben Corporation
1390 N. Manzanita St. • Orange, CA 92867
www.aquaben.com • sales@aquaben.com

SAFE FRESH™

Deodorizers

Protection That Pays™



Scientifically Superior!



Online Ordering!



Unmatched Rewards!



Our exclusive ROI Program pays you back with FREE restrooms when you purchase SAFE-T-FRESH Deodorizers. (Special bonus for new customers)

Unique Triple Action Formula

Earn FREE RESTROOMS

Order A Custom Blend

Expert Advice and Service

Express Shipping



www.safetfresh.com

Place Your Order Online
www.safetfresh.com
 Anytime - 24/7
 Safe and Secure

For Assistance Call:
877-ROI-PAYS
 877-764-7297

SAFE  FRESH™
 Deodorizers
Protection That Pays™

Pumper

see photos in COLOR at www.pumper.com

TRUCK STOP



April



2005 Peterbilt "Juggler": 500 cfm blower, reel for hose, truck has 50,000 miles, AC, 10-spd. Located in Qc, Canada.
.....\$145,000 Cdn.
819-827-2772 or
m.gascon@videotron.ca P4



1995 Ford: 800 series Cummins, 10-spd., 3000 gal. Fruitland pump, new rear suspension.\$21,500
1-800-858-3111 P5



1993 Int. 9400: 360 hp Cummins, 386K miles, 3600 gal. tank, 450 cfm Wallenstein pump, 4" side intake/discharge, rear 6" intake/discharge. Truck, tank and pump in excellent condition.\$30,000 Firm
717-354-5867 • New Holland, PA P4



2000 International Septic Tank Pump Truck: Rig approximately 2 years old, 3500 gallon tank, runs daily.\$35,000
205-841-3060 P4



2007 International (Pre-Emission) DT 466 - 4300: Air brakes, auto. Allison trans., stainless steel tank, 1100 waste, 400 fresh, Conde pump, 43,000 miles, excellent condition. Built by Best Enterprises. ..\$69,900
417-257-4088 P4



1962 B Model Mack: New motor, trans., air ride susp., completely new and restored front to rear, built to work, ready for show. Call Tom with serious inquiries or email.
.....\$52,500
Tom 516-790-5554 -or- tj228@aol.com P5



1999 Ford F450: 4WD, 7.3 diesel, auto trans., 186,000 miles, new trans., newer Crescent tank w/liftgate, 600 waste, 250 fresh, excellent condition, garaged in So. Oregon.\$25,000
541-882-0045 P4



1986 Floater: 3000 hours, 4 shank injector, 250 hp Cat engine, automatic transmission, 3,000 gal. tank\$22,000 OBO
574-848-7704 P4



2000 Freightliner FL80: 250 hp Cat, 2300 gal., 318 cfm Moro pump new in 2006, 100' of 3" hose on a reel, 84,000 orig. miles, owner operated since new, garage kept.
717-733-2339 P4



1999 Ford F550: 7.3, 6-spd. manual trans., 202,000 miles, new clutch, new pump, Satellite 650 waste, 300 fresh. Well maintained and garaged.\$20,000
541-882-0045 P4



1993 Ford LTS 8000: One owner, well maintained, road ready. Lots of extras and new parts. 252,000 miles, 56,000 GVW. Call for all truck details!\$23,500 OBO
262-968-3257 P4



2002 GMC 3500: 4x4 V8 gas/auto., 142,000 miles, 12' flatbed w/liftgate, carries 6 units, 400/100 slide-in, Conde pump w/Honda, water pump, can deliver.
.....\$19,500
920-655-7065 P5



1988 Ford L800: Ford diesel, 2200 gallon tank, runs and pumps good, great starter truck.\$12,000
205-841-3060 P4



1998 IHC 4900, Sreco HV-2000 Sewer Jet: 6 cylinder John Deere diesel upper, DT-466, Allison automatic, 55,115 miles, 1,894 hours. ..\$39,900
814-696-4343 - Hollidaysburg, PA P4



1999 Freightliner: Air, cruise, 10-spd., 215 Cummins, airtag, new rubber, like new, 3250 tank, Masport liquid cooled pump, 160,000 miles, mint condition.
.....\$54,000
989-743-5055 P4



1995 Mack Septic/Great Pump Truck: 5-spd. trans., 3,200 gal. tank, new Demag/Wittig vac pump truck. Looks and runs excellent.\$38,500
561-753-3446 P4

Pumper TRUCK STOP

see photos in COLOR at www.pumper.com



April



Shower and Restroom Trailers: Platinum and Gold Series, new and used available. Each with separate men and women sides.

CCI/Brian Touey 805-896-3777 PBM



2005 F550 4X4 Diesel: 6-spd., XL package, H2 Masport pump, 950 gal. tank, 600 waste, 200 chemical, 150 fresh, 2-place toilet rack, 75,000 miles.....\$37,500

Call Ryan at 801-430-7287 P5

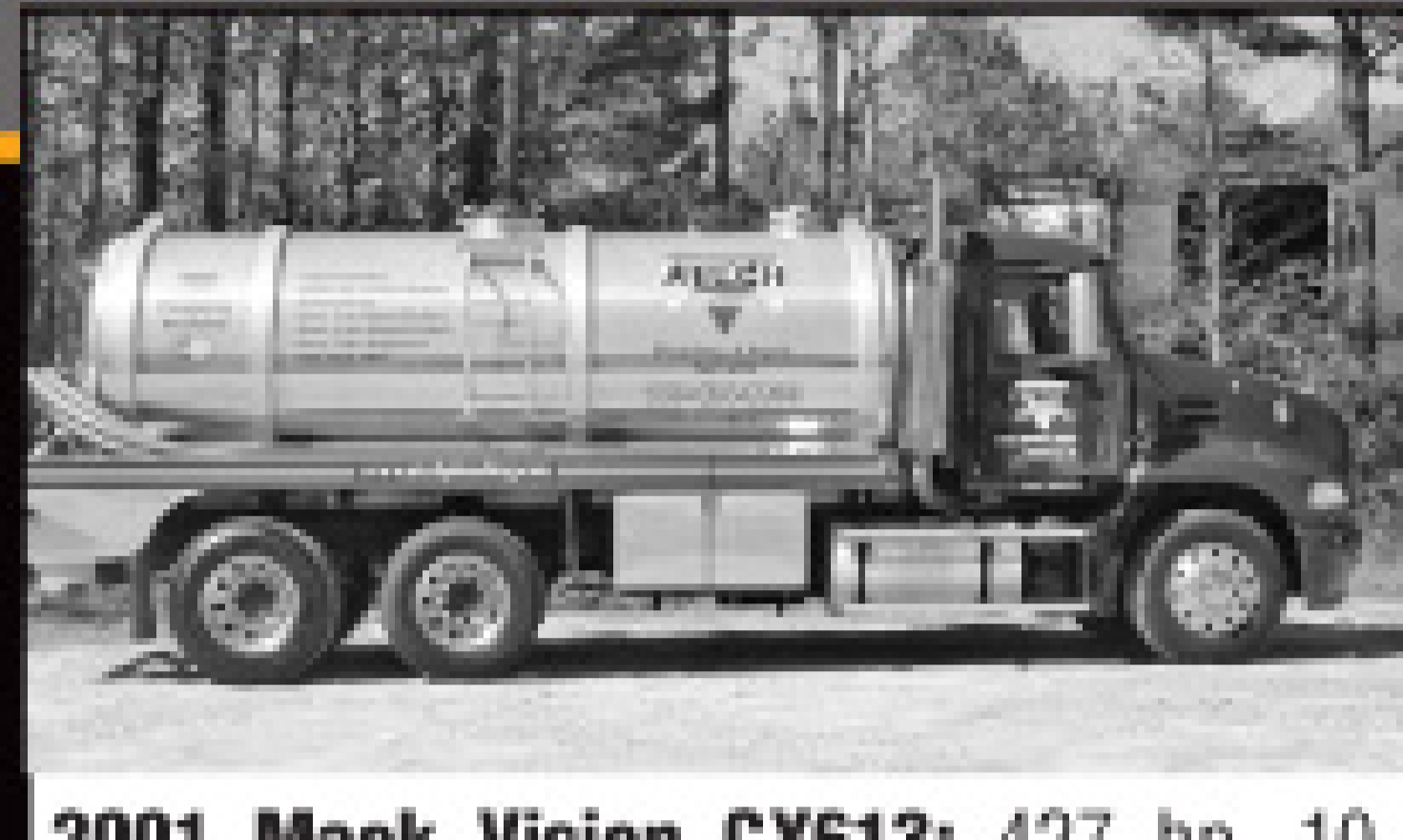

2001 Mack Vision CX613: 427 hp, 10-spd., Jake brake, A/C, cruise, air ride, custom paint, 3600 gal. aluminum tank, 200' hose, Fruitland pump RCF 500, 350 cfm, 2-4' inlets.\$68,900 OBO

770-434-8600 P4



2001 International 4900: DT466, 6+1 transmission, 87,000 miles, 2150 gallon vacuum unit, 2-3" inlets, 1-6" discharge, 200' 3" suction hose.\$34,000

Call Terry 734-777-0390
Michigan Vacuum Trucks P4



1987 S1900 International: Diesel w/Myers high pressure power jet, 45 gpm pump, 1200 gal. fresh water holding tank, single rear axle, 2-stage trans.\$16,500 OBO

1-866-352-6870 P4



1987 Vactor 810 Ford L8000: 136,826 original miles, single stage 60 gpm pump, 1200 gal. fresh water holding tank, single rear axle, newly painted.....\$25,500 OBO

1-866-352-6870 P4



2006 International: 4000 Series, Model 4300, DT 466, 6-spd., H4 Masport pump, 1500 gal. tank, 1000 waste, 150 chemical, 350 fresh, 2-place toilet rack, 130,000 miles.\$36,000

Call Ryan at 801-430-7287 P5



1975 Chevy: 366 V8 engine, 10-wheeler, Model 175B Calwell drill/bucket rig, triple Kelly capable of 90 drill depth, 42 ring gear capable of drilling 8' diameter.\$50,000

Paul 909-721-2608 P4



2007 Sterling Cab: With 3600 gallon aluminum P/V tank with Juro-Pak R260.

.....\$116,000 including FET
800-722-8384 PBM



1998 Terralift: Extra probe, extra parts. Included is the 1995 Pequea trailer that carries the system.\$15,000

724-222-6080 P4



IN PROGRESS 2007 Freightliner M-2: 250 hp Cat, 6-spd. manual, 18,000 miles, full factory warranty, NEW 2500 gal. vac. body, Masport HXL400WV vac pump, 2 man-ways, 3 sight eyes, 4" discharge, 3" inlet, painted to suit.\$67,000

Call Terry 734-777-0390 P4



2005 GMC 4x4: 30,000 miles, 10,000 GVW, auto, 400/200, brand new Masport pump, new water pump, 2-toilet fold-down carrier, excellent shape.\$26,500

Massachusetts 978-386-5616 P4



1995 Guzzler Vac Truck: 28" H.G. liquid ring vac pump, new tires, new paint, great running truck.\$65,000 FIRM

609-332-4149 P4



Vac-Con V390 Combo Units: Low mileage, refurbished 2004, 9 cu. yd. capacity, 60 gpm pumps. Call for more information.

.....\$45,000
703-313-6771 P4

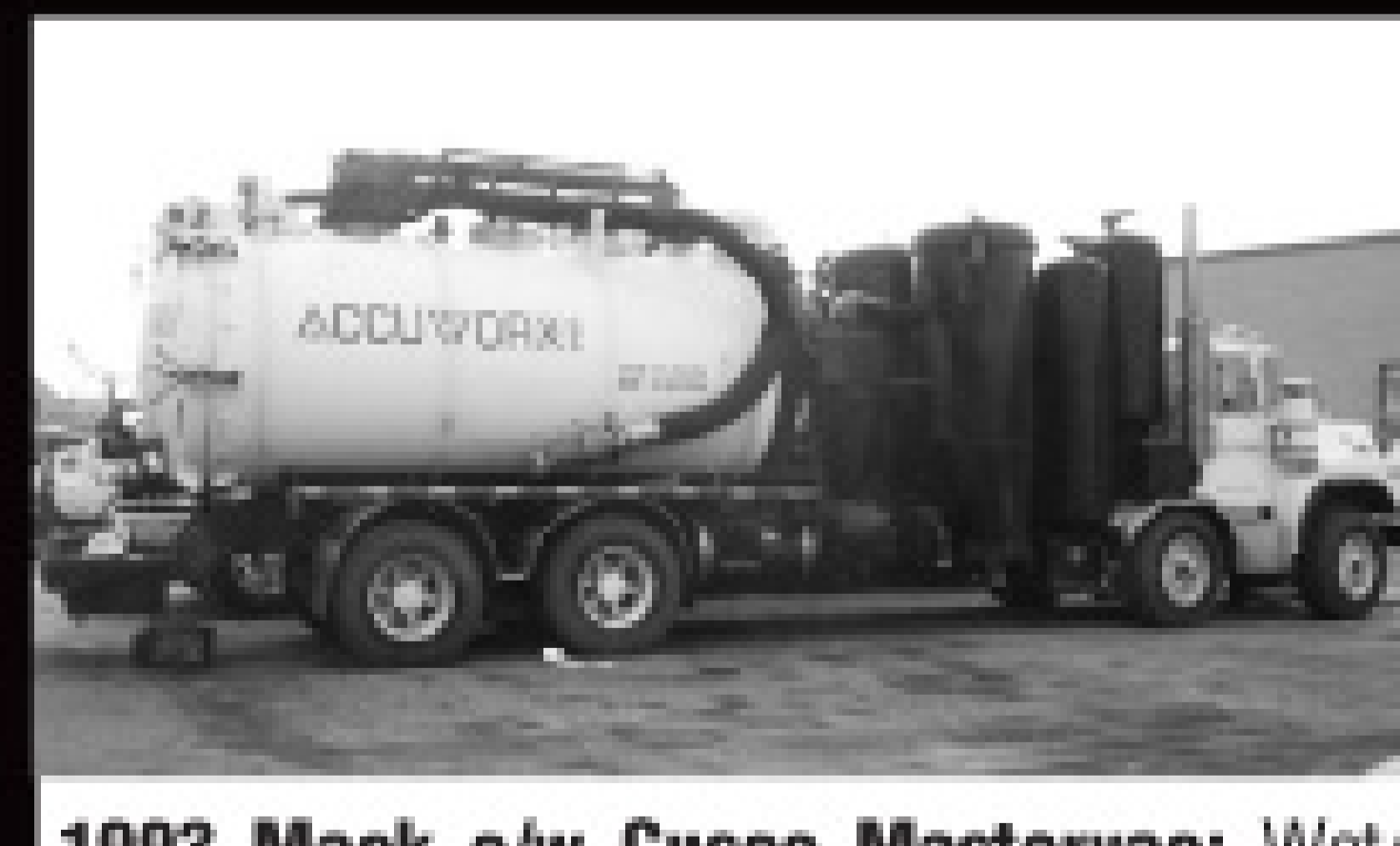

1993 Mack c/w Cusco Mastervac: Wet/dry, 5300 cfm blower, with pump off, full opening rear door, full dump, dual bag-house, hose trays, boom, PERFECT.

.....\$90,000
Call Jason 416-509-5520 P4



2000 International 4900 Nearing Completion: DT466/225 hp, manual trans., NEW 2500 gal. vacuum body, Masport 400 cfm vac. pump, 24"x24"x60' alum. tool box, 100' 3" suction hose.\$39,400

Call Terry 734-777-0390 P4

Pumper TRUCK STOP

see photos in COLOR at www.pumper.com



April



1999 IHC 8100: New 2500 gal. carbon steel tank, new NVE pump package, 6' dump, 4" inlet, 36" rear manway, Cummins M-11 350 hp, standard trans., 32,000 GVWR.....\$41,250

352-323-6284 X 201

P4



2000 US Jett 10K and 4K: 600 gal. tank, 100 hp Deutz, 747 hrs., mounted in 14' heated box on a 2000 Chevy 6500, 45K, Cat dsl., excellent condition.

641-673-9377 or 641-660-6991

CPBM



2000 Mack Tri-Axle: 4895 gal. alum. vac tank, 280 fresh water, 1/4" 3300 psi water jetter, winter ready, heated valves & jet unit, 20,000 front axle, 44,000 rear, AC, power windows, 4" load, 6" discharge, hot shift PTO, 24" manway.....\$65,000 OBO

608-568-3000

P4



DM 600 GK 1991 Mack: 250 hp, 6-spd., 300K on truck, 4000 gal. tank, fresh paint, very nice truck, ready to work.\$19,000

410-287-3545

P4



2001 Ford F-750: Diesel, 6-spd., 180,000 miles, 2150 gal steel tank, Battioni pump, runs and drives good.\$30,000 OBO

Paul 616-218-3155

Hamilton, MI

P4



2002 FL60 Freightliner: 180K miles, 3126 Cat motor, new clutch, trans., A/C compressor. 1500 gal. waste, 200 gal. water, new MEC 8000 pump. Lots of extras. Please call!\$47,400 OBO

830-560-0021

P4



2000 Freightliner FLD 112: C-10 CAT 370 hp w/Jakes, 10-spd., 12 FA/40 RA air-leaf susp., new 80 BBL vac tank with new 350 cfm liquid cooled Wallenstein vac pump. Excellent condition and ready to work. Only 370,000 miles!!\$58,500

720-253-8014

P4



1976 FWD 6X6: 5000 gal. carbon steel non-vac truck, injection unit, 6" load, 30" top load.\$18,000 OBO

608-568-3000

P4



IME Vacuum Hydro Vac: 500 gal., PB-3 vacuum pump, Onan engine, tandem trailer, new tires.\$7,000 OBO. Also 2001 Imperial slide-in unit, 450 gal., Honda engine, very good. \$5,000

Paul 616-218-3155

Hamilton, MI

P4



1997 Mack: 350 hp Mack engine, 20 front, 46 rear, Hendrickson suspension, new 3500 gal. tank and Masport 400 vac pump, new paint and tires.\$59,000

877-898-5104

hullstruckbodies.com

P4



2005 Freightliner: FMI 1500/500 aluminum tank, Masport pump, pressure washer, dual service, cabinets, 29K miles, 2683 hrs, CAT C-7, 9-speed, new tires, like new condition.....\$67,000

719-633-8709

www.bestwaydisposal.com

P4



1985 Ford L 9000: Fresh 350 hp Cat engine, 8LL transmission, 4,000 gal. tank, 500 cfm pump, new tires, strong productive truck.\$30,000 OBO

574-848-7704

P4



1998 Peterbilt Vacuum Truck: 3500 gal., 275 hp Cummins, 8LL, 20,000# ft., 38,000# rr, 150,000 miles. Very good condition.

845-279-6069

P4



1991 Vactor 2110-38: Ford L8000 3-axle, Ford diesel, Allison, engine brake, rebuilt PD blower, 60 gpm @ 2000, 65,000 miles on axles, 256,000 miles on odometer. Located in NorCal.....\$42,000

707-433-8053

P4

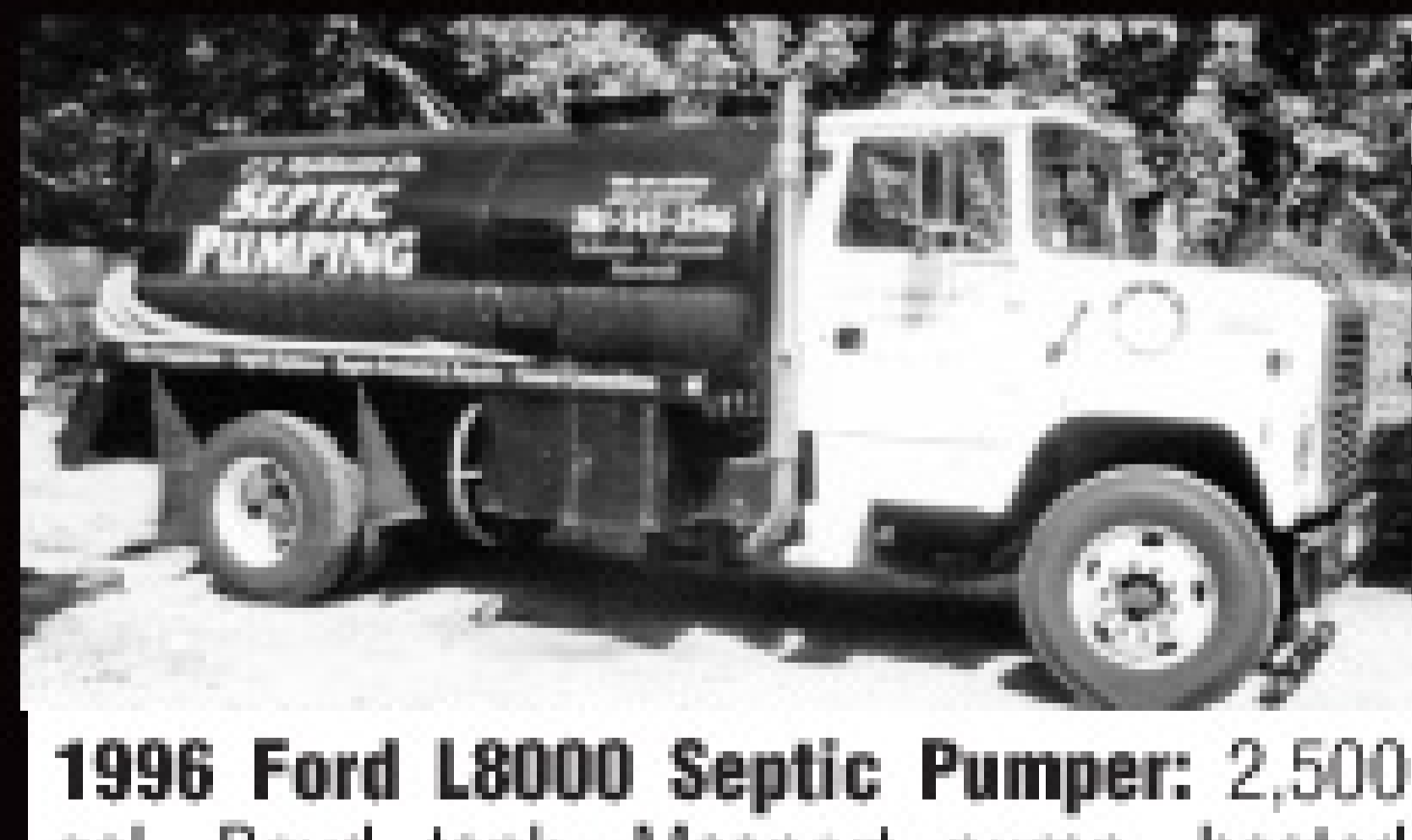

1996 Ford L8000 Septic Pumper: 2,500 gal. Boyd tank, Masport pump, heated valves, 63K miles, 33K GVW, Ford/Cummins 8.3L diesel, 6-spd. trans., A/C. Located in Scituate, MA 02066. ..\$32,900

781-545-2596, 617-697-2607,

617-697-2606

P4



1999 Vactor 2115: 15-yd. debris body, 1500 gal. water capacity, 80 gpm, 2,500 psi pump, PD blower.

Call Joe 312-208-6373

P4

PLACE YOUR AD ONLINE AT www.pumper.com - IT'S ALWAYS THERE TO MEET YOUR BUSY SCHEDULE

Irrigation fittings are for irrigating – NOT vacuum.
 How many dollars are you spending **SUCKING AIR?**
 Industry-proven, quality vacuum couplings from Bandlock
 will put money into your pockets.

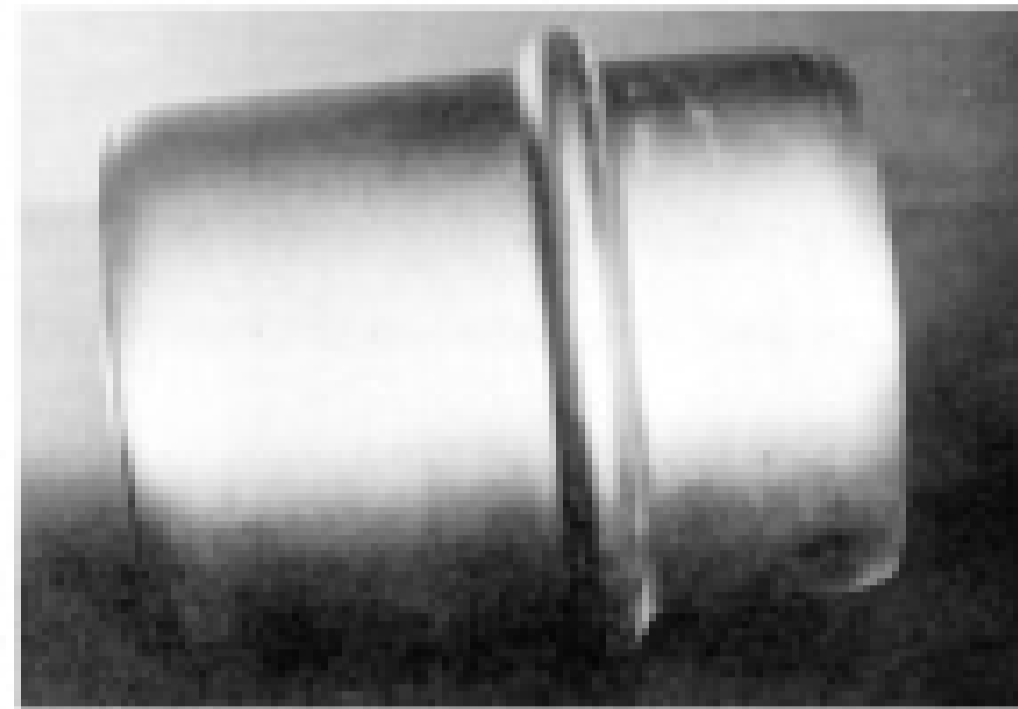

BANDLOCK BL
4" to 12" MR Male Coupler



BANDLOCK BL
4" to 12" FR Female Coupler



Aluminum Coupler RLM
6" and 8" Aluminum
Male Weldon



Steel
Crown
4", 6"
and 8"
Press
End

**CLOSE TOLERANCE
 COUPLERS AND
 FITTINGS BRING
 "SAFETY" TO YOUR
 WORK PLACE.**

**Recognized
 as the
 #1
 Relief Valve
 in the
 World**

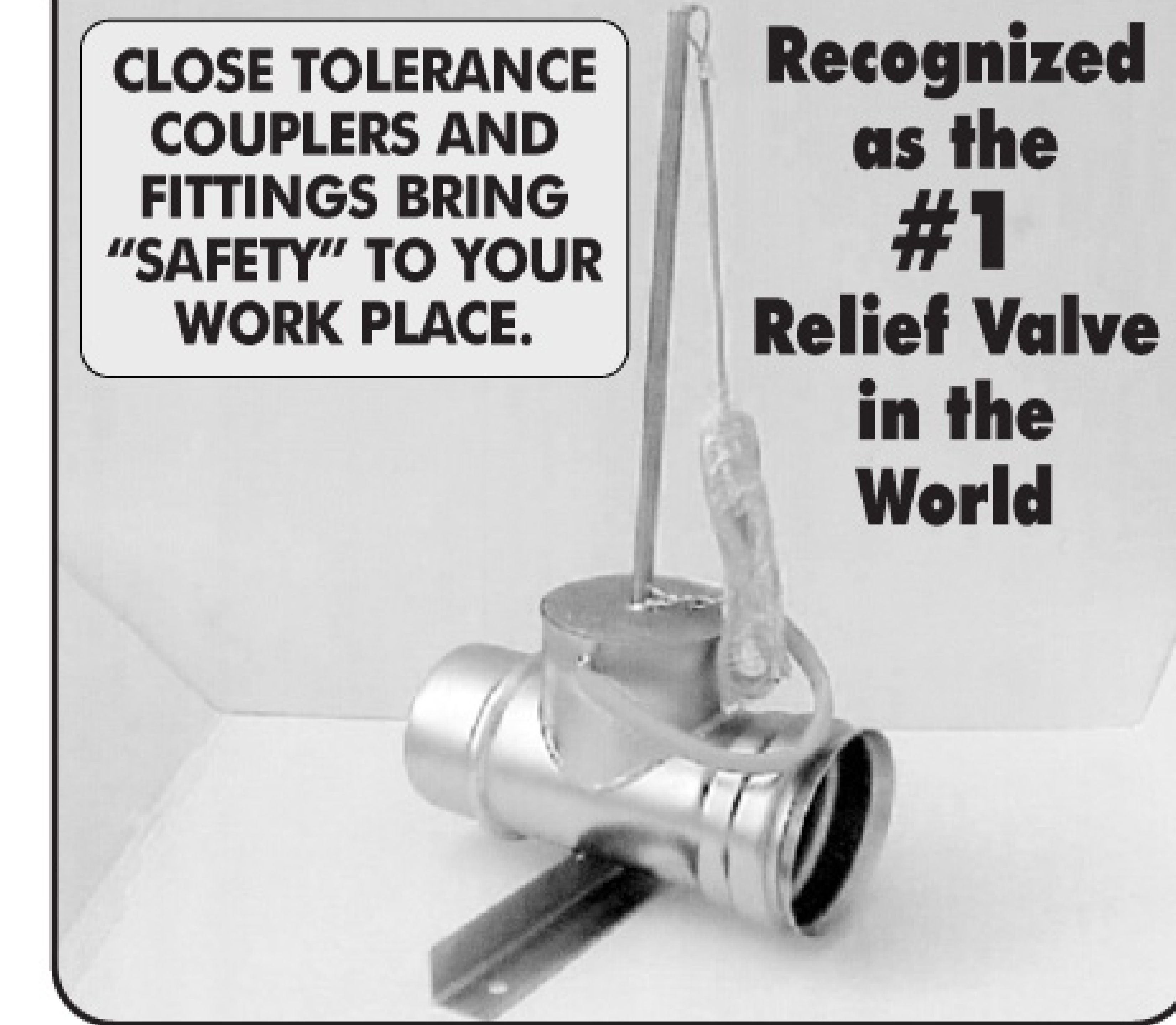

Aluminum Pipe with Steel Press Ends,
Steel Pipe Weldons, Aluminum Weldons

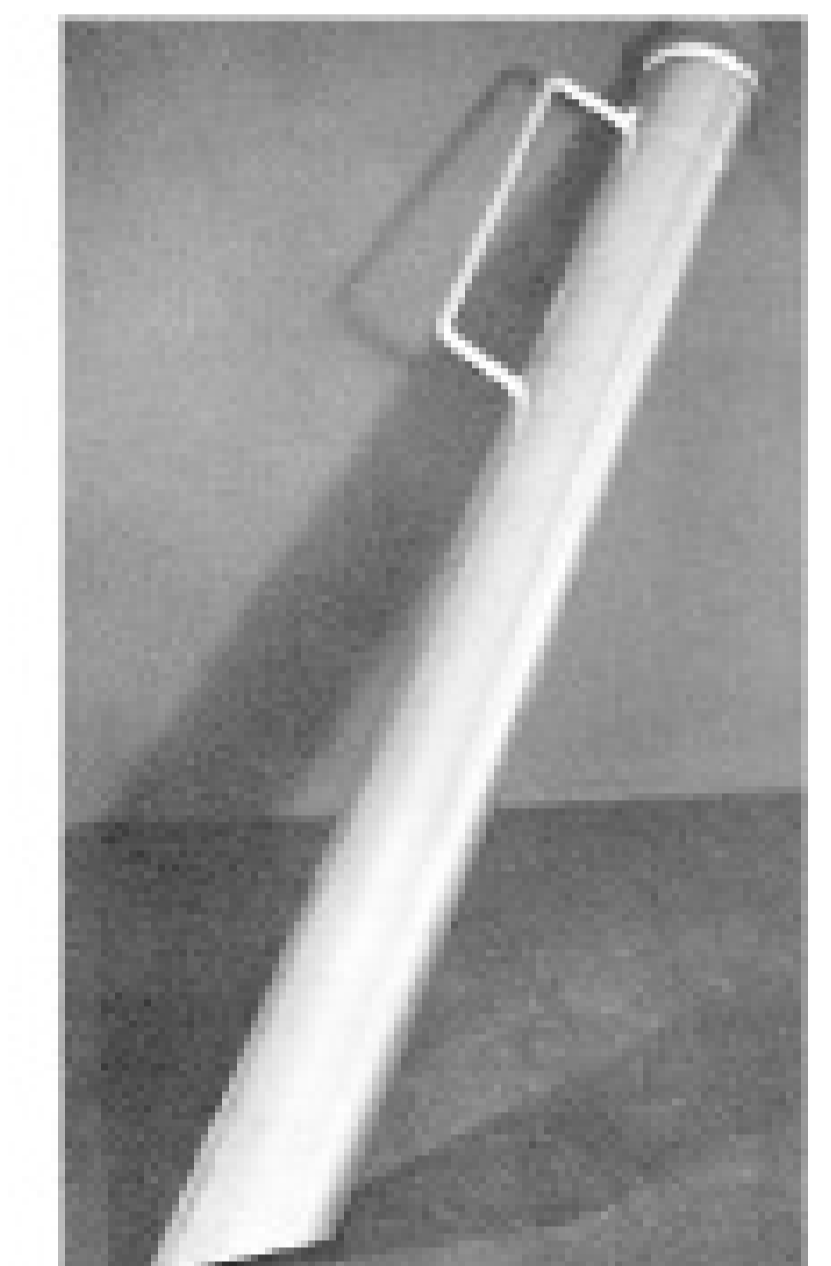

4" and 6" High
Abrasive Bulk Nozzles
Steel Reinforced



BANDLOCK Reducers
BL-300
All Size Combinations



Special "Y" Reducer
Any Size



Special "Y" Plus Reducer
Any Size



Special "Y" Plus Reducer
Any Size



BANDLOCK "Y"s: BL "Y"
4" to 12"

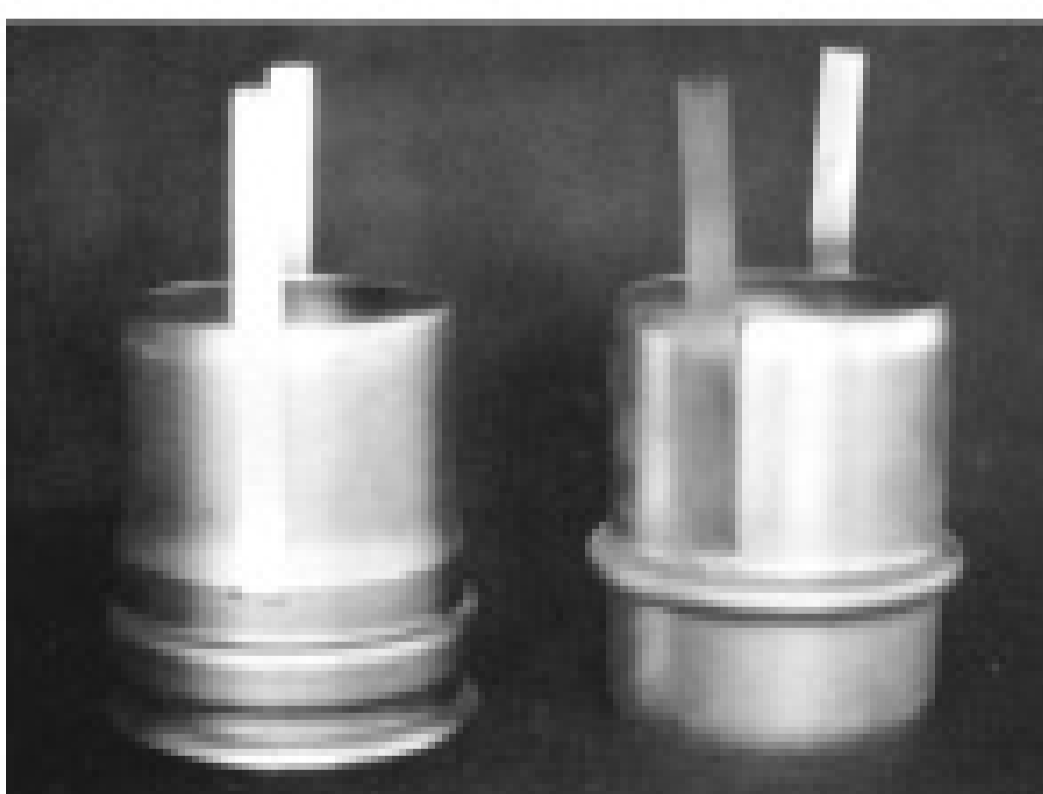

BANDLOCK Safety Discharge
Female Coupler, Male Coupler
BL-SFR 4" to 12", BL-SMR 4" to 12"



BANDLOCK Clamp
Standard and International
BLB 4" to 12"

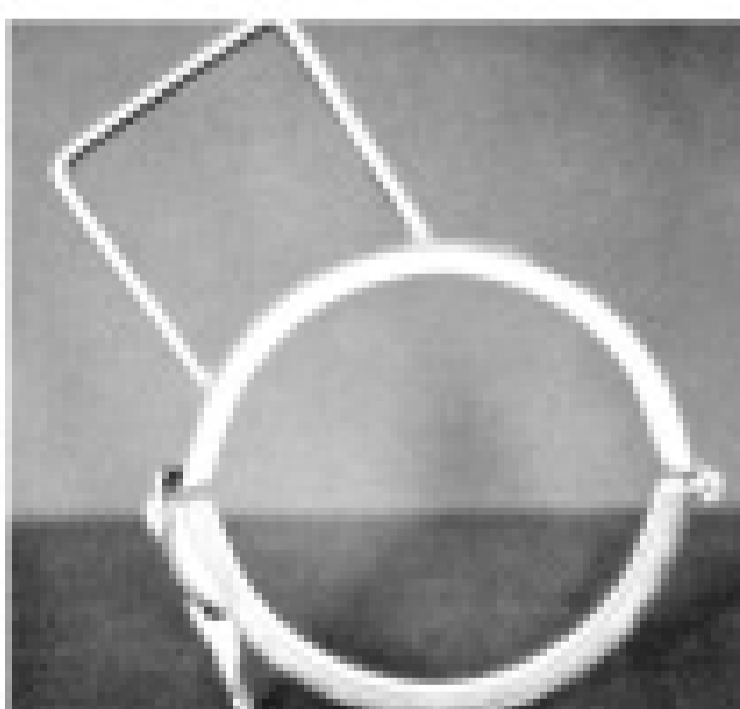

BANDLOCK
EZ Lift Clamps
BLB-EZ 4" to 12"

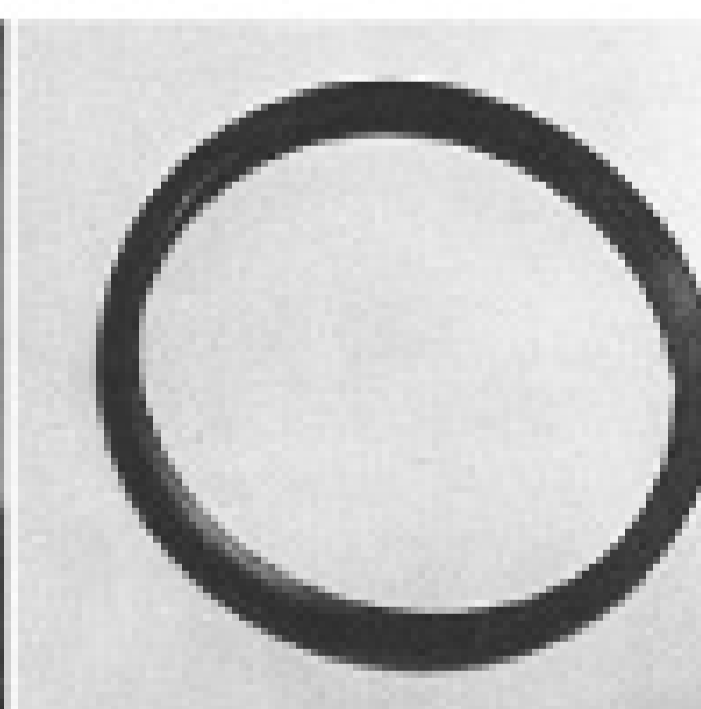

Profile Gaskets (Safety)
4" to 12" Seals
for Hazardous Materials



GO - 4" to 12"
Rubber Gaskets



Male and Female
BL-500M or BL-500F End Plug
4", 5", 6", 8", 10" & 12"



BANDLOCK Safety Discharge
Coupler - Male Clamp, 2 Gaskets,
Clamp with Safety Straps

**BANDLOCK
 Corp.**

MADE IN THE U.S.A.

SUPERIOR "QUICK" CONNECT VACUUM AND PRESSURE COUPLINGS AND ACCESSORIES

Call or fax today to get your catalog!

1-800-659-2978

Fax: 909-930-2551

www.amesbury.com

jcaprio@amesbury.com



Wet Valve, 6", 360° Injected

Green since 1959!

For all your Onsite Wastewater Needs



D-Boxes



Heavy Duty Cover and Adapter Ring for Corrugated Pipe



Pump and Filter Alarms

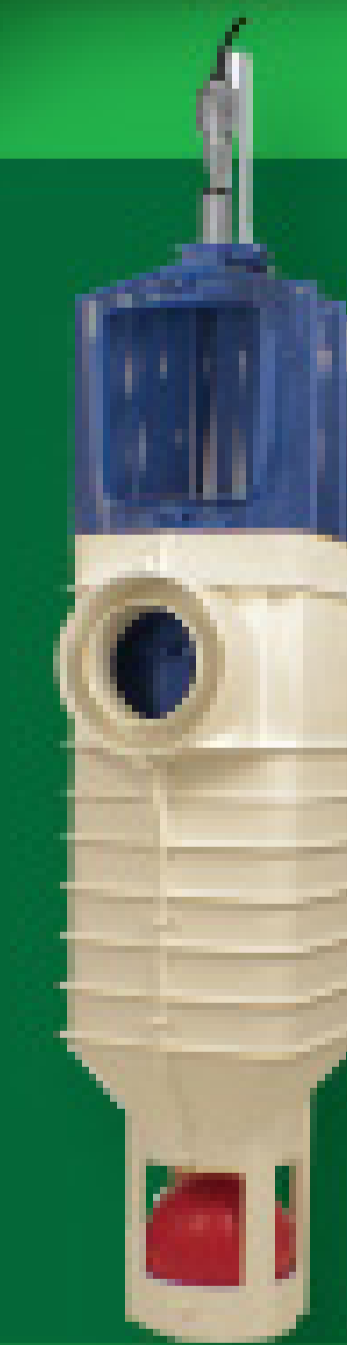

Effluent Filters



Risers



1-800-701-3942

For a Free catalog or to see other products call or visit our website: www.zabelzone.com

Always in Your Corner



Tough Products & Knowledgeable People

there when you need us

800-292-1305
www.polyjohn.com

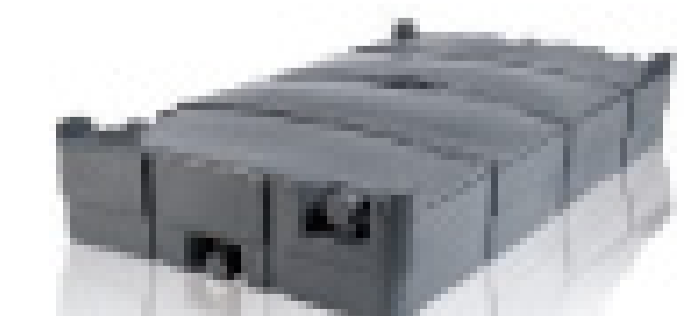
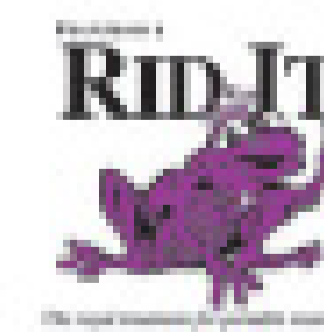
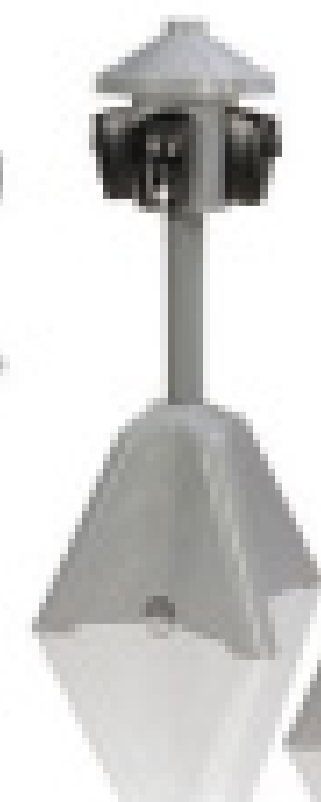

EARN MORE • SELL MORE • SERVICE BETTER

PRESVAC

**The Leader
In Vacuum
Technology**

Bright finish Aluminum Tanks

**for the Septic Pumping
Industry... Standard
tank models from
2,000 gallons
to 5,000 gallons.**



Hydro-Trencher - 5300 CFM air flow/28" HG vacuum

**with 8" hydraulic actuated boom, 3000 U.S. gal.
debris tank (stain. steel 316), 1000 U.S. gal.
water tank (stain. steel 316), 9 G.P.M. water
pump with pressures to 5800 p.s.i.**

Powervac 5300 for wet/dry operation

**5300 CFM air flow/28" HG vacuum, Dump chutes
extended to rear of truck, Stainless steel 316,
DOT 407/412**



Liquid Truck

Designed for industrial liquid applications

www.presvac.com

**Nationwide Sales & Service
Call a Presvac Dealer in Your Area!**

4131 Morris Drive • Burlington, Ontario, Canada L7L 5L5 • Fax: 905-681-0411

905-637-2353 • 800-387-7763