

Vacuum Trucks & Components • Fleet Management & Maintenance

DEDICATED TO THE LIQUID WASTE INDUSTRY

Pumper®

March 2008 www.pumper.com \$5.00 U.S.

MAN OF STEEL

Shop-savvy Minnesota contractor shares truck buying and repair tips

PAGE 40



Foot Soldiers Wanted

Business booms for
Virginia pumping pro

PAGE 80



Our Trucks Are Ready. Are You?

Select From Existing Inventory or Build Your Own.

Available Inventory

- 4800 Aluminum Septic Tank
- 3600 Aluminum Septic Tank
- 2500 Aluminum Septic Tank
- 3400 X Ten High Tensile Carbon Steel Front Lift (Full Rear Opening Door)
- 2200 Stainless Steel Premium Septic Tank
- 3200 Stainless Steel Premium Septic Tank
- 3600 Aluminum Septic 2008 Kenworth T300
- 1250 Alum PRT 2007 Ford F550 2x4
- 1500 Alum PRT 2007 Ford F550 4x4
- 800 Alum P&D Combo Unit 2007 Ford F550 2x4
- 2200 Alum Septic 2007 7500 Chevrolet
- 2200 Alum PRT 2008 Ford F750 AT AB
- 1500 Alum PRT 2008 Ford F550 2x4
- 2000 Alum PRT 2007 International 4200 AT AB

PORTABLE RESTROOM TRUCKS

- (6) 950 MD Steel - \$51,000 w/Ford F550 Chassis
- (6) 1250 MD Steel - \$59,328 w/Ford F650 Chassis
- (6) 1600 MD Steel - \$63,128 w/Ford F650 Chassis

Available For Immediate Delivery!



\$ 103,652

**Kenworth T-300
3600 Aluminum**



\$ 85,965

**Peterbilt 335
2500 Aluminum**

Order Today!

800-328-3332

www.satelliteindustries.com



Imagine The Possibilities

www.masportpump.com

www.masportpump.com

www.masportpump.com

Best Bet in Town

Louisville 2008



HXL4V Plug & Play
Best in Porta-Potty Class

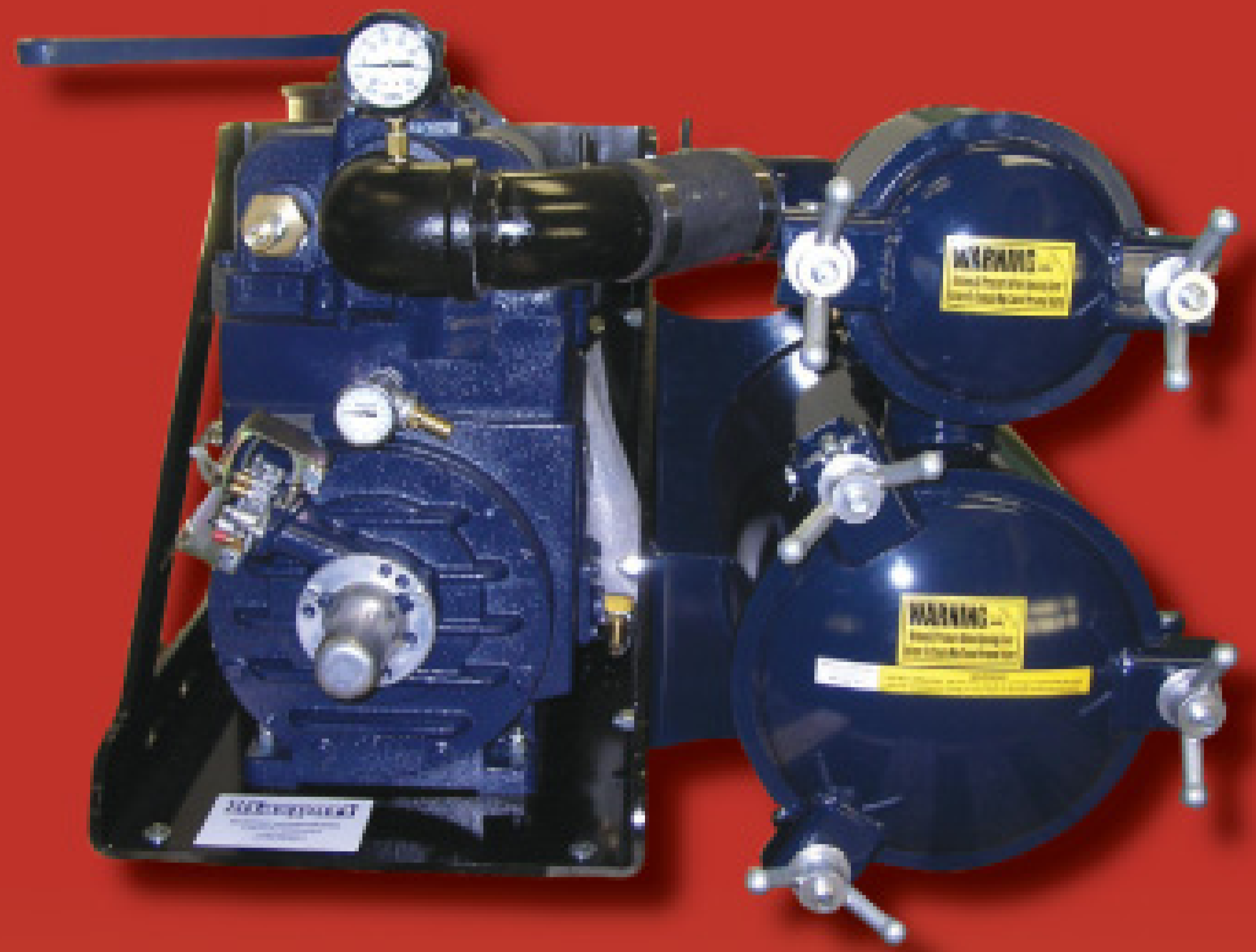

HXL400WV Plug & Play
Best in Liquid Cooled Class



Demister
Best in Components Class

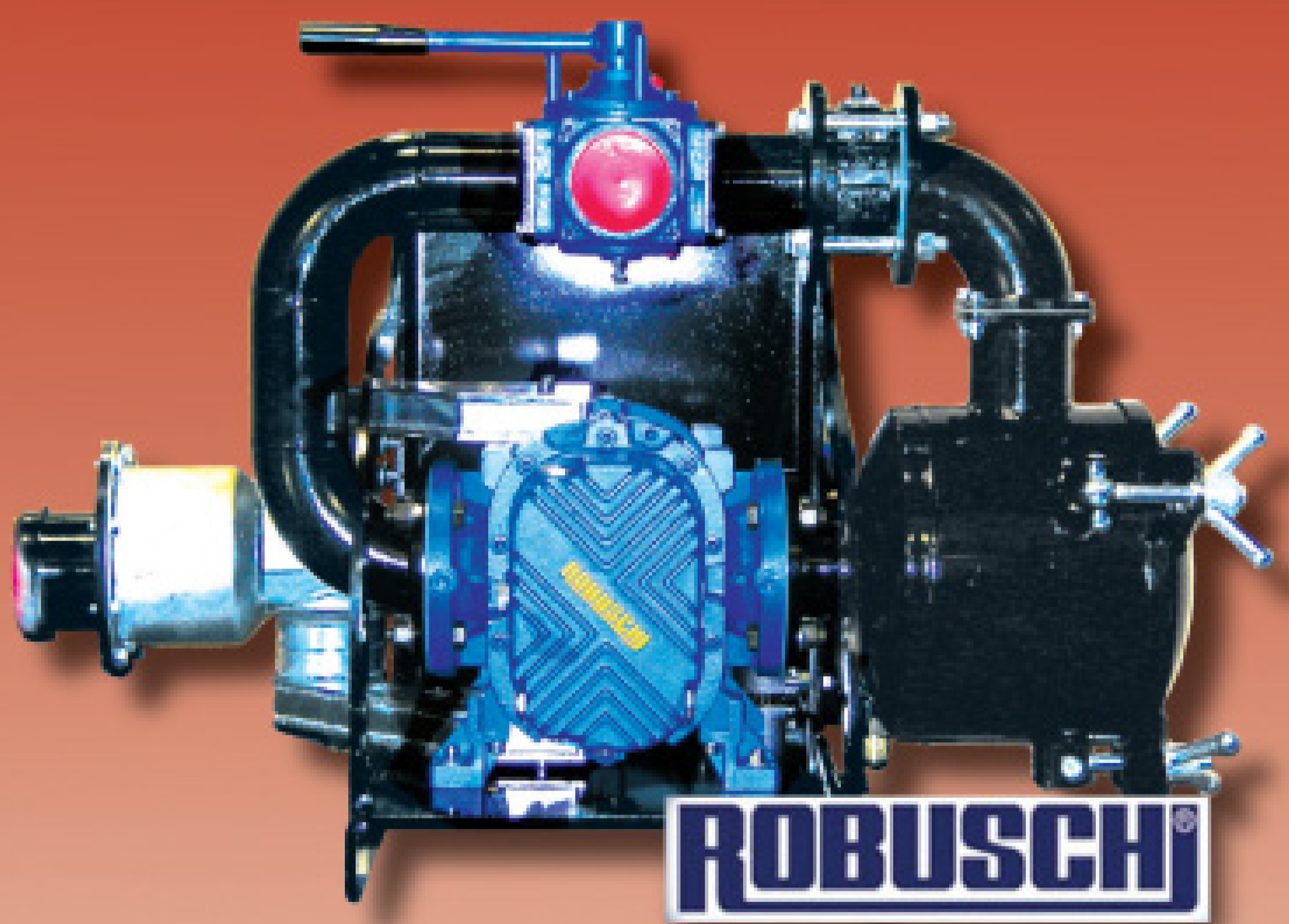

RB-DV High Vacuum Blower
Best in Blower Class

TO ORDER CALL: 1(800) 228-4510

90600

© 2008 Masport Incorporated All Rights Reserved

Masport®



Restroom Dropped On Site

NEW PORTABLE, COMMERCIAL QUALITY RESTROOMS



Interior/Restroom Stalls Interior/Utility Sink Storage Tanks

- Heat & AC
- Lighting
- Rubber or Rhino Lined Flooring
- Electrical Outlets
- Hot Water Heater
- Utility Sinks
- Urinals & Stalls
- Self Contained 1500 gal Fresh Water Tank/1500 gal Sewage Tank
- Or Hook Up Directly to Existing Utilities
- Level Indicator Alarm

PROFIT GENERATION

- \$ Monthly Rental
- \$ Bulk Pumping
- \$ Potable Water Hauling

POTENTIAL CUSTOMERS

- Special Events
- Industrial/Construction Sites
- Community Functions

DROP BOX 1.888.388.7768
www.dropboxinc.com

Inventory of New & Used!

We Build Pumper Trucks

- ✓ 1,500 Gooseneck Vacuum Trailers
- ✓ 1,500-3,400 Gallon Vacuum Trucks

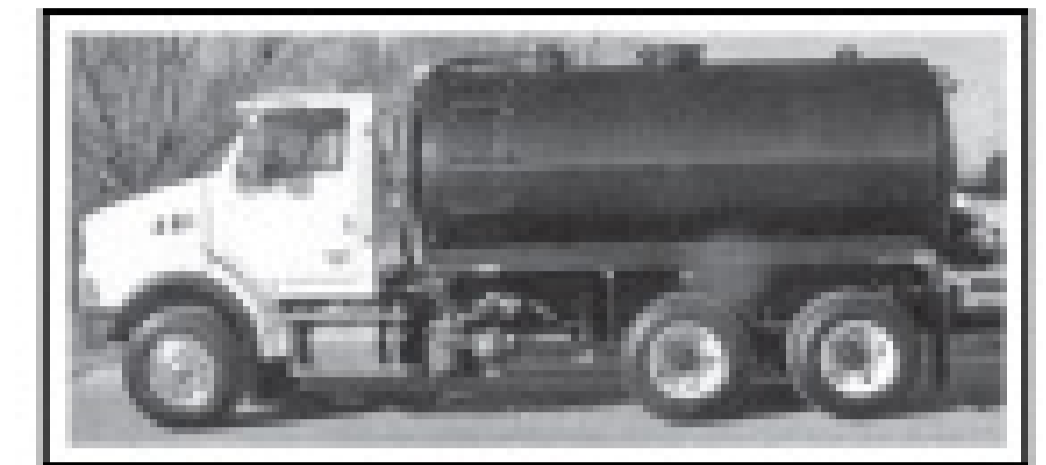
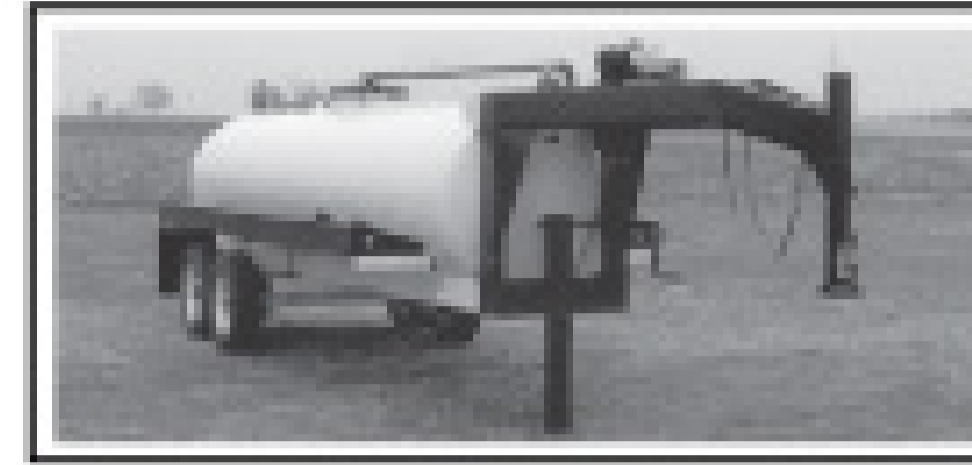

Moro Pump Dealer



Redneck Trailer Parts Dealer

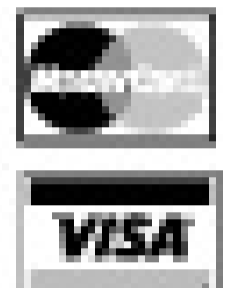

B&W .. Because Nobody Has Time for Down Time



ALL TANKS ARE MADE IN THE USA
ALL TANKS ARE COMPLETED AND THEN PRESSURE TESTED

B&W MANTRAD INCORPORATED
4000 E. Jackson • Macomb, IL 61455
309-837-1989 • fax 309-837-1919 • bandwent@macomb.com

40 Years Experience

CALL TODAY FOR INFORMATION OR PRICES ON TANKS, PUMPS AND ALL PARTS

Lenzyme

Quality Sells ~ Sell the Best



Top-Rated

- ➔ Premeasured Packets
- ➔ FREE Educational Brochure
- ➔ FREE Private Labeling

BEST PACKAGING - BEST PRODUCTS - BEST PRICES



Call Today for Your **FREE** Sample

1-800-223-3083

920-436-8266 • Lenzyme, Inc.

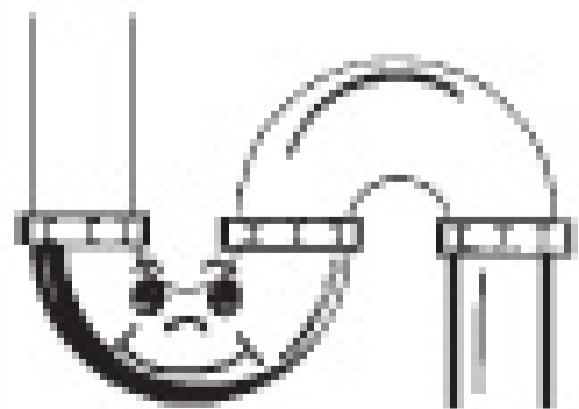

The **5**

Enzyme - Bacteria Grease and Waste Digestant

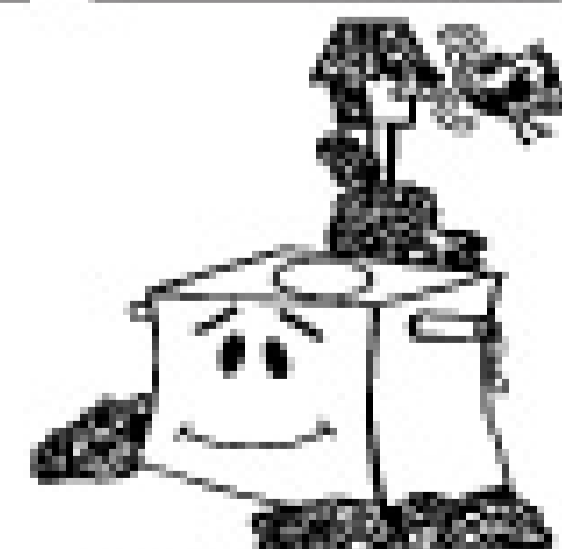
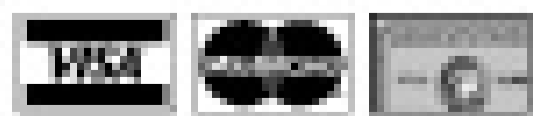

RouteOptix Inc.



- Customer Service
- Optimized Routing
- Visual Dispatch
- Asset Management
- Disposal Tracking
- Customer Billing



Thanks for visiting us!

A Complete Software Solution

(866) 926-7849

www.routeoptix.com

info@routeoptix.com

EXPAND YOUR BUSINESS
TO WHEREVER THE OPEN
ROAD WILL TAKE YOU.





THE SYNERGY WORLD

HIGH TECH II
DELUXE FLUSH TRANSPORT

THE MOST AFFORDABLE,
HIGH-END, RESTROOM
TRANSPORT AVAILABLE.

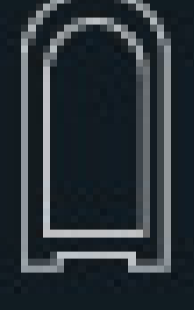

There's no better way to cater to the special event market than with the High Tech II Deluxe Flush Transport (D.F.T.) – a heavy-duty drop-axle trailer fitted with two top of the line High Tech II Deluxe Flush units.

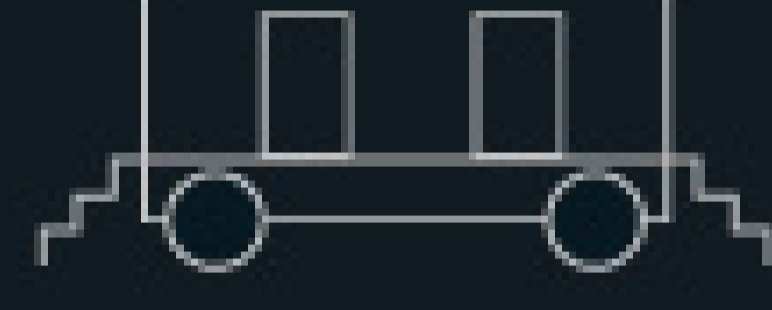
SUPERIOR DESIGN & AMENITIES		MORE AFFORDABLE, NO ELECTRIC HOOKUP NEEDED	
			
Poly Unit with Flush	High Tech II Deluxe Flush	Powered Trailer Unit	More affordable than power-dependent trailer units, superior flush system over other poly units, best amenities available for comfort

On site, the D.F.T. secures the restrooms only two inches off the ground making setup a breeze. Inside, you'll find the modern amenities of the High Tech II such as the industrial grade flushing system and clean-water handwash. Simply fold down the hitch, raise the platform and the D.F.T. is ready to head off to its next destination.

Contact your area sales manager at (800) 352-1986 or visit us on the Web at PORTABLETOILET.NET for more details...THE FUTURE IS HERE, TODAY.

To learn more, visit us on the Web:
PORTABLETOILET.NET

Contact your area sales manager at:
(800) 352-1986



ARTICLES

40

Man of Steel

- Jim Kneiszel

On the cover: Metalworking Minnesota contractor Greg Posch shares his truck-building and maintenance tips. On the cover, Posch checks under the hood of his most recently refurbished rig, a 1988 Ford L8000. (Photo courtesy of Tri-County Septic)



10

Reading Between the Lines: Transmission Talk

Who wins auto vs. manual shift debate at your house?

- Jim Kneiszel

20

Building the Business: Corralling Insurance Costs

Higher deductibles, safety programs and security measures help control rising business insurance costs.

- David Wall

30

Rules and Regs: Long-Delayed California Rules are Back on Track

- Scottie Dayton

56

Employee Motivation

Four steps to raise the level of enthusiasm and feeling of job satisfaction among your workforce.

- George Hedley

70

Pumper Interview: Onsite Systems Get a Bad Rap in Georgia

A theory that septic systems contribute to reservoir drawdown is flawed, according to industry leaders.

- Scottie Dayton

80

Foot Soldiers Wanted

Virginia's Taylor's Septic Service & Portable Toilets Inc. looks for hardworking employees to aid in an expansion effort.

- Richard Ryman

90

Overheard Online: Supporting the Vacuum Tank

Shopping for a new pump truck, a poster wonders about the best way to support the weight of the tank barrel.

100

Lighter Side: A Helping Hand

Arizona's Palmer's Benjamin Franklin Plumbing donates time and supplies for various local charitable causes.

- Jim Kneiszel

REGULAR FEATURES

95

Association News; Training and Education; Calendar

110

Money Manager: Nurturing the Nest Egg

Market watchers warn of investment pitfalls that can drain funds earmarked for the golden years.

- Ted J. Rulseh

116

NAWT News: Association Training Benefits Pumpers and the Environment

- Tom Ferrero

120

Reader Pipelines: We Need to Fix What?

How do you convince cost-conscious customers to move forward with necessary septic tank repairs?

- Mary Shafer

124

Product News: Spotlight — SSI-290 Biodiesel Processor

- Ken Wysocky

126

Septic System Answer Man: Go with the Flow

For the most accurate picture of sewage treatment capacity in a home, you have to crunch some numbers and make good guesses.

- Roger E. Machmeier, Ph.D

130

Industry News

138

Classy Truck of the Month

We feature Steve 'O' Septic, Monticello, Minn.

Coming in April

Special Issue: Portable Sanitation

- **Pumper Interview:** New United Site Services leader bullish on portable sanitation
- **Contractor Profile:** Technology assists one-man shop in Montana

Pumper.

DEDICATED TO THE LIQUID WASTE INDUSTRY

www.pumper.com

Published monthly by

COLE Publishing Inc.
1720 Maple Lake Dam Rd.
PO Box 220
Three Lakes WI 54562

© Copyright 2008 COLE Publishing Inc.
No part may be reproduced without
permission of the publisher

In U.S. or Canada call toll-free 800-257-7222
Elsewhere call 715-546-3346
E-mail: info@pumper.com
Web site: <http://www.pumper.com>
Fax: 715-546-3786

Office hours 7:30 a.m. - 5:00 p.m.
Central Time, Monday - Friday

SUBSCRIPTION INFORMATION: A one year (12 issue) subscription to *Pumper* in the contiguous 48 U.S. states costs \$16 (24 issues for \$26; 36 issues for \$36). Subscriptions to Canada or Mexico cost \$28 per year (24 issues for \$54). Subscriptions to all other foreign countries cost \$82 per year. Subscribers are guaranteed monthly delivery of the magazine. To subscribe, send company name, mailing address, phone number and check or money order (U.S. funds payable to COLE Publishing Inc.) to the address above. MasterCard, VISA and Discover are also accepted. Supply credit card information with your subscription order.

CLASSIFIED ADVERTISING: RATE: \$1.00 per word, per month. Minimum of 20 words or \$20. All classified advertising must be PAID IN ADVANCE. **DEADLINE:** Classifieds must be received by the first of the month for insertion in the next month's edition. **PHONE-IN ADS ARE NOT ACCEPTED.** Ads may be faxed only when charging to MasterCard, VISA or Discover. Please supply all credit card information with faxed ads. Be sure to include your phone number (with area code) in your ad. Make checks payable to COLE Publishing Inc. and mail with classified ad to the address above. **CLASSIFIED ADVERTISING APPEARS NATIONWIDE AND ON THE INTERNET.** Not responsible for errors beyond first insertion.

DISPLAY ADVERTISING: Call 800-994-7990 and ask for Jeff, Jim, Kim or Winnie. Publisher reserves the right to reject advertising, which in its opinion is misleading, unfair or incompatible with the character of the publication.

CIRCULATION: Circulation averages 24,493 copies per month. This figure includes all three circulation regions (nationwide) and international distribution.

2009 PUMPER & CLEANER

ENVIRONMENTAL EXPO INTERNATIONAL



Education Day:
February 25, 2009

Exhibits Open:
February 26-28, 2009

Kentucky Exposition Center
Louisville, Kentucky

www.pumpershow.com



moroPUMPS

"Over 50 years of service and here to stay!"

Ask for a quality Moro pump from your truck builder, or call us for the dealer nearest you.

Pittsburgh, PA . 1-800-383-6304 . fax 412-269-4172 . www.morousaeast.com . moroeast@attglobal.net
St. Louis, MO . 1-866-383-6304, 636.584.8844 . fax 636-583-2044 . www.morousaeast.com . moro@charter.net

Isn't it time to UPGRADE to a MORO?

Thanks for visiting us in Louisville!



Complete Right Angle Packages

Completely Assembled

M3
176 cfm



Pumps available from 176-1642 cfm

M10
230 cfm



PM80 350 cfm

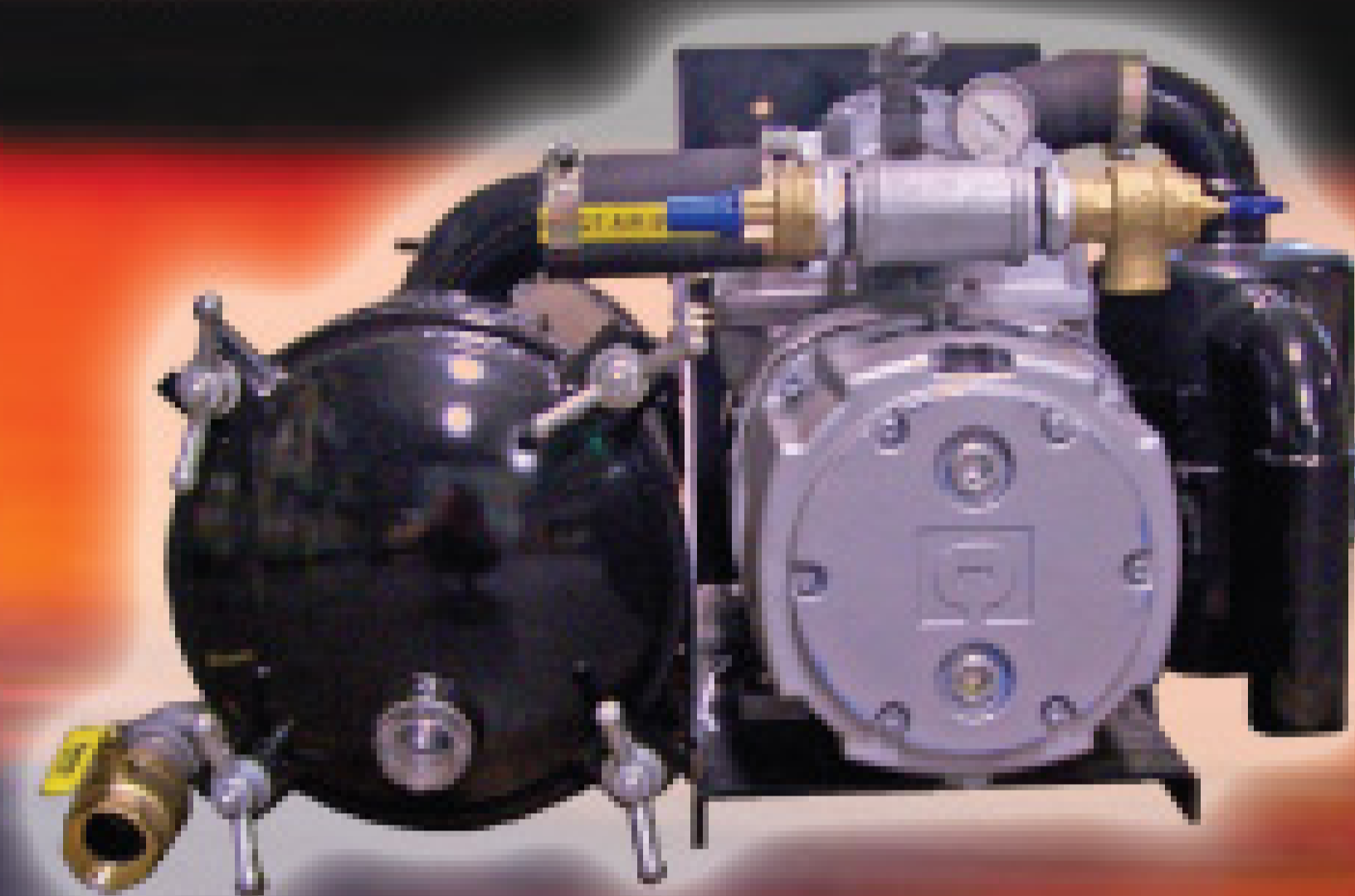

PM100
460 cfm



RIGHT ANGLE, HYDRAULIC,
GAS OR DIESEL PKGS.
AVAILABLE
ON ALL PUMPS

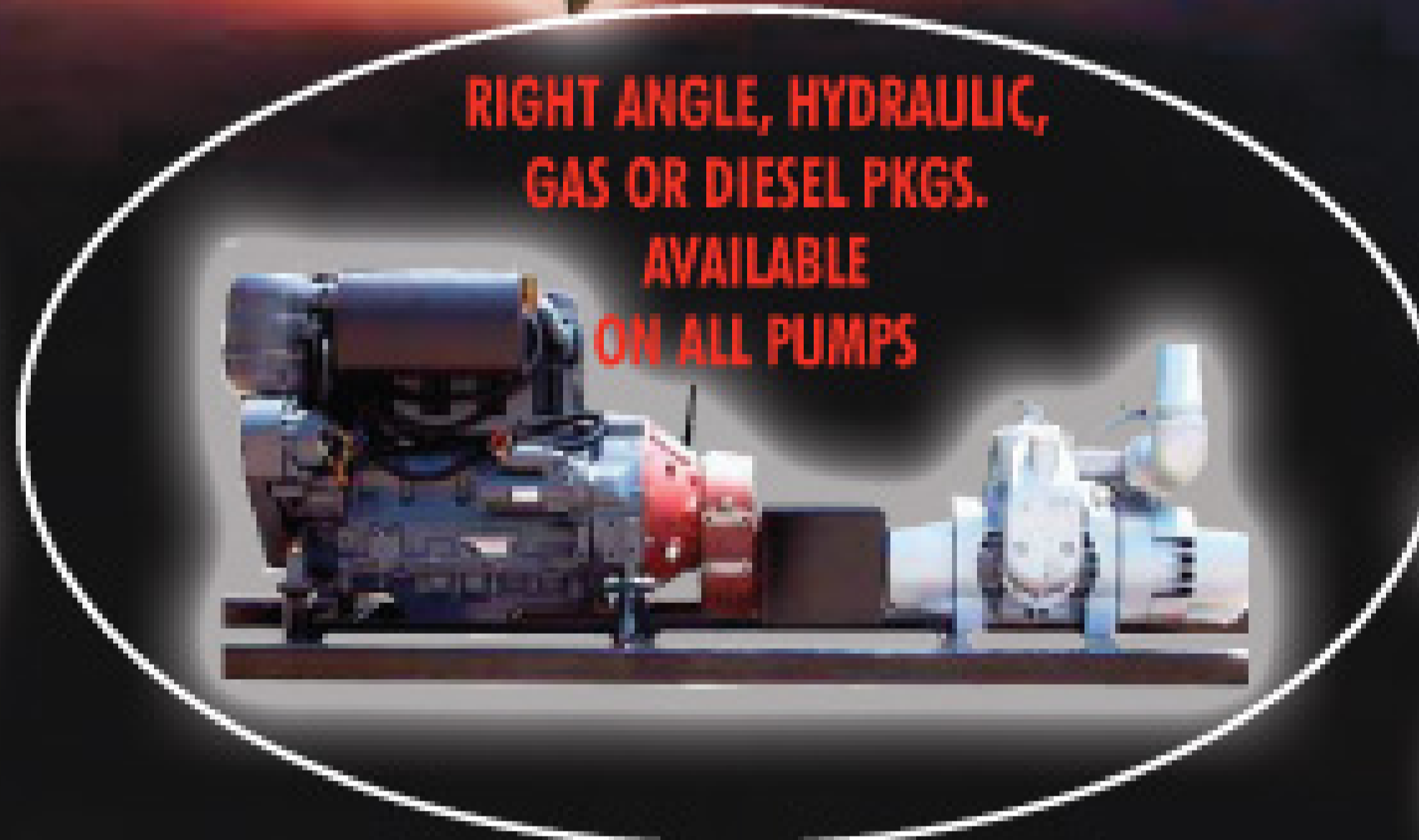

PM2600 824 cfm

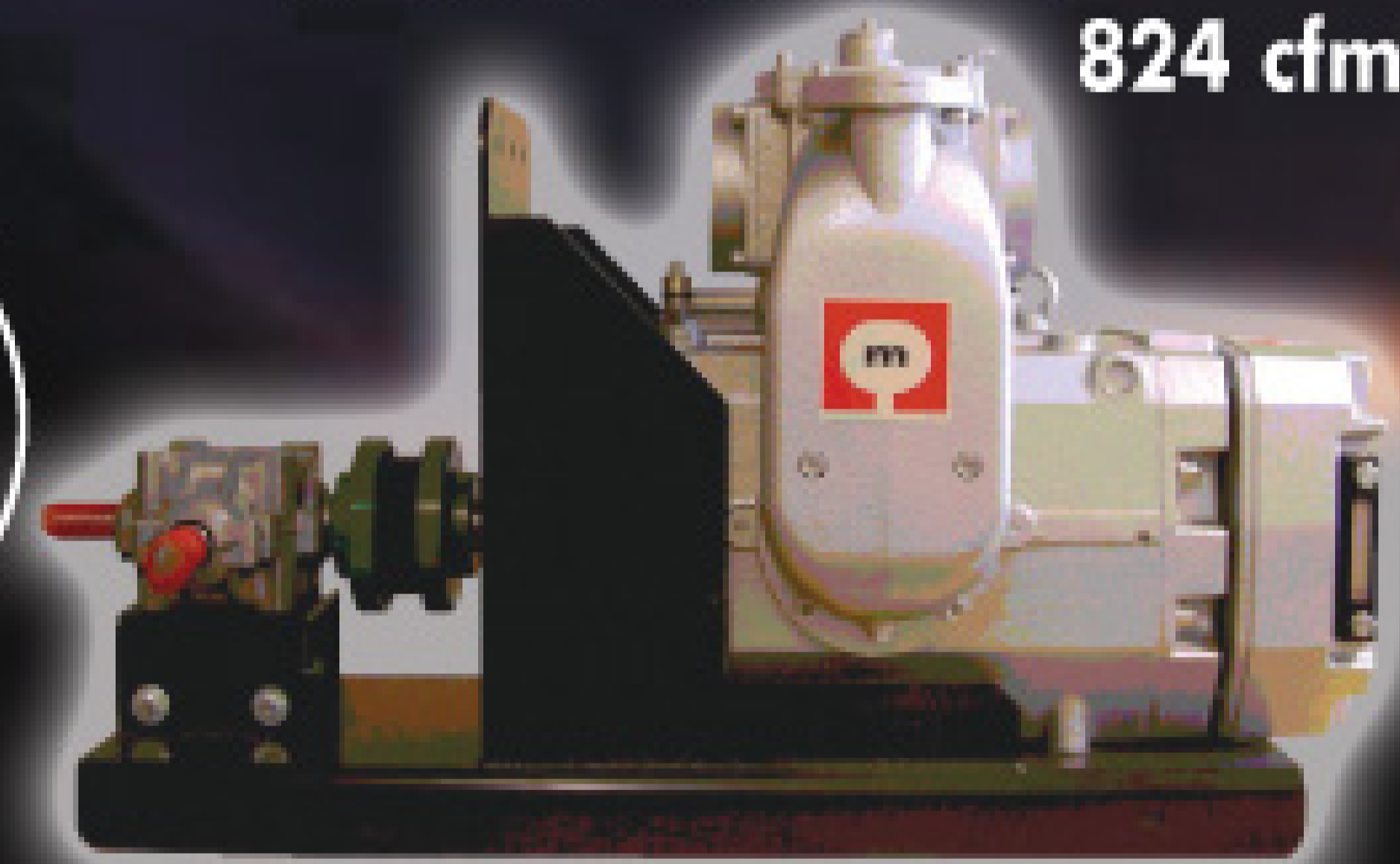

DC-STAINLESS Washdown Pump

NO COMPARISON

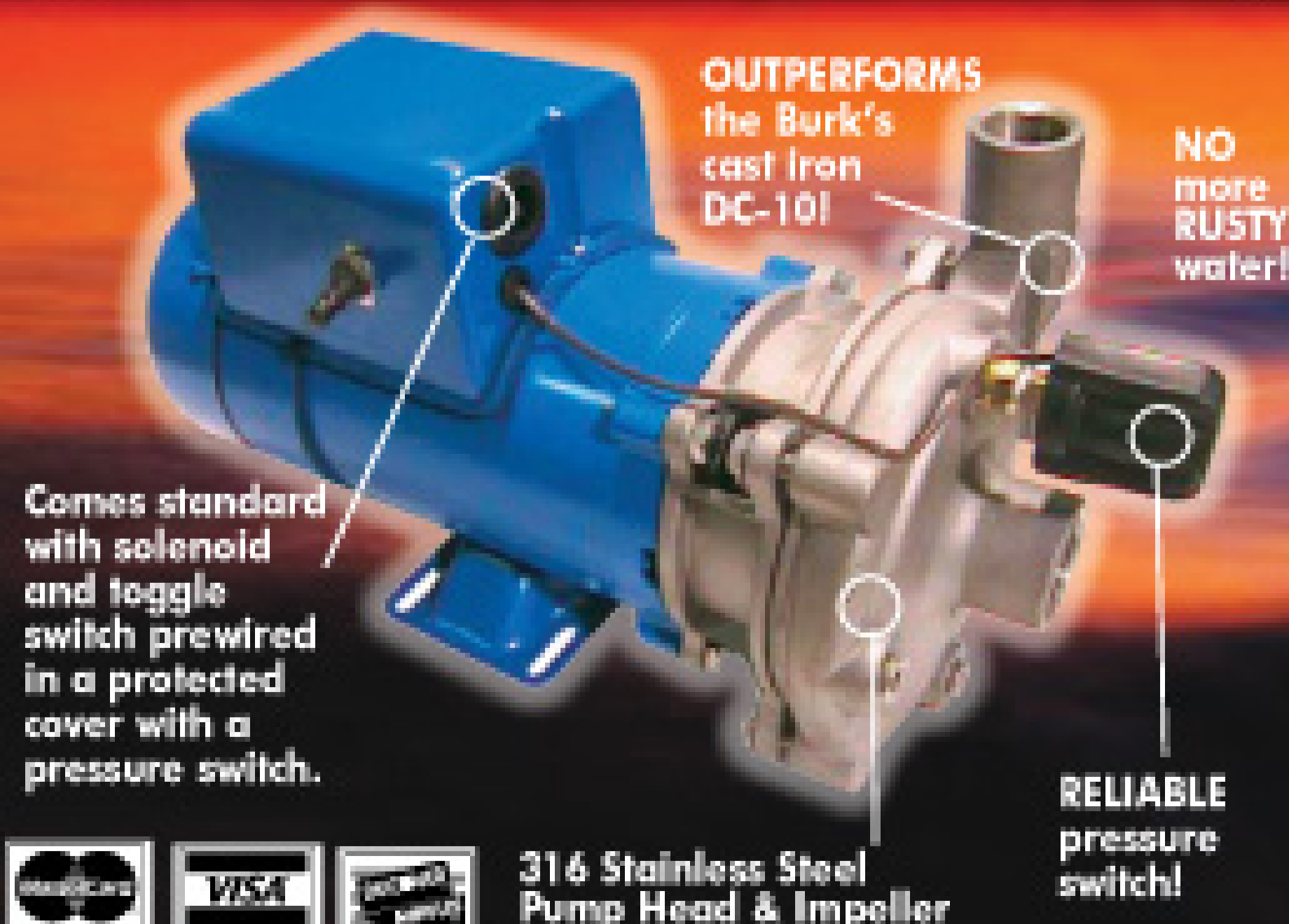

OUTPERFORMS
the Burk's
cast iron
DC-101

NO
more
RUSTY
water!

Comes standard
with solenoid
and toggle
switch prewired
in a protected
cover with a
pressure switch.

RELIABLE
pressure
switch!



316 Stainless Steel
Pump Head & Impeller

Quality RIV Components In Stock — Ready for Shipment



ACCU-LEVEL Accurate Tank Volume Measurement

No Balls • No Tubes • No Floats • No Worry!
No Internal Tank Components

Get paid for what you pump!

Only pay for what you dump!



Level Indicator

Factory calibrated, the general purpose indicator reads 0-100% of volume in gallons. A single push button allows users to scroll through their active channels.



Pick-up Unit

The general purpose two-wire transmitter provides non-contact level measurement up to 32' and is ideally suited for challenging corrosive, coating or waste liquids.

ADVERTISER index

March 2008

27th Trucks, Inc.35

A



Abbott Rubber Co., Inc.112



Abernethy Welding & Repair16
Accent Manufacturing60
ACG Equipment Finance114
Acro Trailer Company26



Advance Pump & Equip.89
Advanced Containment Sys.18
AltumaMats92
Ameri-Can Engineering98
American Machine & Tool Co.66
Amigo Truck Ltd.112
Amthor International24
Aqua Ben Corp.92
Aqua Blast Corp.36



Aqua-Zyme Disposal Sys.52



Arcan Enterprises Inc.54



ARMAL Inc.11-13



Armstrong Equipment38, 102
Atlanta Rubber & Hyd.43

B

B & W Mantrad Inc.4
Badger Truck Center32
Balzer Inc.121



Bandlock Corp.51
Best Enterprises, Inc.37
Big Fish Environmental130
Black Tie Mfg. Inc.87
Brenlin Co. Inc./Seal-R60



Bright Technologies24

C

Cadman Power Equipment.84



Cam Spray106
Cape Cod Biochemical117
Capital Partners LLC71



Capital Rubber Corp.84

C

Center Capital Corp.53



Chandler Equipment Inc.9
Chempace Corporation22
Circle D Truck Sales38



Clear Computing Inc.64



Comforts of Home138
Community Leasing76



Crust Busters/Schmitz Bros.28

D

Del Vel Chemical Co.91
Denver Truck Sales127
Dragon Products14-15
Dresser Roots Blowers113
Drop Box Inc.4

E

Ecological Laboratories122
Ecosolve22



Elastec/American Marine32

Engine & Accessory Inc.64
Excel Equip. & Supply31
Explorer Trailers - McKee64

F



F. S. Solutions10
Fergus Power Products95
Five Peaks Technology39



Flo Trend Systems Inc.34
Fruitland Tool & Mfg.36

G

Gamajet Cleaning Systems18
GapVax Inc.33
Global Vacuum Sys. Inc.29
Granite Leasing Co.65

H

H & M Vacuum Pumps28
Hampel Corp.49
Hannay Reels54
House of Imports63

I

IHI Compact Excavator Sales 78
Imperial Industries Inc.119

J



J&J Chemical Co.77
J.C. Gury Company Inc.28

J

Jack Doheny Supplies Inc.67



Jag Mobile Solutions27

K

KeeVac Industries Inc.59
Keith Huber Inc.52
Kentucky Tank Inc.34
Key Commercial Corp.86
KMH Equipment Inc.46
Kuriyama of America Inc.76

L

L.C. Tanks109
L.M.T. Inc.68
Labrie Environ. Group102
Lane's Vacuum Tank Inc.94

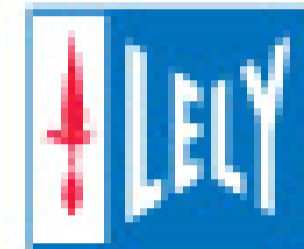

Lely Manufacturing Inc.85



Lenzyme/Trap-Clear Inc.4
Liberty Financial Group92
Longhorn Tank & Trailer Inc.60

M



Marsh Industrial88



Masport Inc.3
Michigan Vacuum Truck Inc.46
Micro Target Media50
Mid-Continent Truck Sales ..131
Mid-State Tank84
Milwaukee Rubber Prod.88



Moro USA East Inc.7

N

National Truck Center57
National Vacuum Equip.111



NuConcepts22

O

Overland Tank Inc.106

P

Pat's Pump & Blower127



Pik Rite, Inc.66
PolyJohn Enterprises147
Polylok Inc.146
PolyPortables Inc.69, 129
PolyPortables Inc./Green Way17
PowerFlo Products Inc.62, 108
Precision Tank & Equip.104



Pressure Lift Corp.72

P

Presvac Systems Ltd.148
Prime Solution Inc.36
Progress Tank73
Prometheus Partners123



Prototek100

R

RA. Ross N. E.86



RABCO30
Reelcraft Industries Inc.97



Ritam Technologies LP91
Robinson Septic Service91
Rocket Supply Corp.76
RotoSolutions Inc.72
RouteOptix Inc.4
Rush Refuse Systems93

S

Satellite Industries...2,5,74-75,105

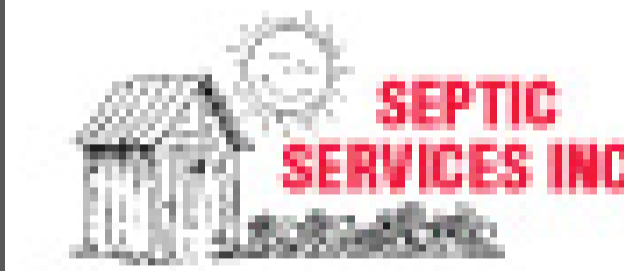

Septic Services Inc.26
Smithco Mfg. Inc.58
Specialty B Sales48
Stuart Tank71
Super Products LLC121
Surco Products25
Sweet Septic Systems Inc.72

T



T&T Tools Inc.118



Tank Technologies & Supply Co LLC
TankTec44-45
Tank Truck Service54



The Service Program66



Toico Industries Inc.61



Transport Truck Sales101



Transway Systems Inc.23
Truck Town Inc.122
TSF Company Inc.103
TST, LLC99
Tuf-Tite Inc.47

U

U.E.M.S.I.48

V

V.E. Enterprises Inc.55
Vac-Con, Inc.107
Vacutrix Limited117



Vacuum Sales Inc.19, 78



VAR Co.128
VMSoft Products24

W

Walex Products Co.115
Wallenstein Pumps-Elmira58
Water Cannon68
Wee Engineer Inc.21



Wells Cargo COG62
Westmoor Ltd.79, 94
White River Distributors114
Wilcox Truck Sales86
Wolf Creek Co., Inc.88

Classifieds132
Marketplace139
Truck Stop142

REGIONAL ADVERTISERS

Western Supplement

(after page 130)

Armstrong Equipment1
Custom Tank & Equip.4
Erickson Tank & Pump3
Glendale Welding5
James Wilbee Company.7
West-Mark Inc.5

Midwest Supplement

(after page 130)

Allied Tank1
Bosserman Tank & Truck2
Engle Fabrication Inc.2
Marengo Fabricated7
Mid-State Truck Service8
Milwaukee Rubber4
Pierson Co.6
Rider Vacuum Sales3
T-Line Equipment Inc.5
V&H Inc.6

Eastern Supplement

(after page 130)

Allied Tank1
Andert6
Bosserman Tank & Truck5
Cellofoam5
Manchester Hose4
Marengo Fabricated7
Southcoast Equipment3
TSI2
V&H Inc.6

Jurop

NORTH AMERICA

by



**COMPLETE
PACKAGE**

SHAFT DRIVE PACKAGE INCLUDES:

- SUCTION GROUP
- Inlet & Outlet Silencers
- Air Controlled 4-Way Change Over Valve
- Final Filter
- Non-Return Check Valve
- Flanges & Bolt Package

LC420 CONTENDER WATER COOLED VACUUM PUMP



The **LC420 CONTENDER** is designed to pick up the heaviest hazardous and non-hazardous sludge that most vacuum pumps can't.

The Proven Power of the **LC420 CONTENDER** Vacuum Pump by **JUROP** knocks out those challenging jobs efficiently and profitably.

This **Water Cooled Champion** supplies 425 CFM, 27" Vacuum, 25" Continuous Vacuum and hooks to truck engine requiring no auxiliary cooling system.

FOR A JUROP DEALER NEAR YOU CALL 1-800-342-0887 www.chandlerequipment.com

BIG THINGS

COME IN SMALL PACKAGES

**EASY
INSTALLATION**

**COMPACT
DESIGN**

**795
CFM**

**1500 RPM
INPUT**

**27"
CONTINUOUS
DUTY**

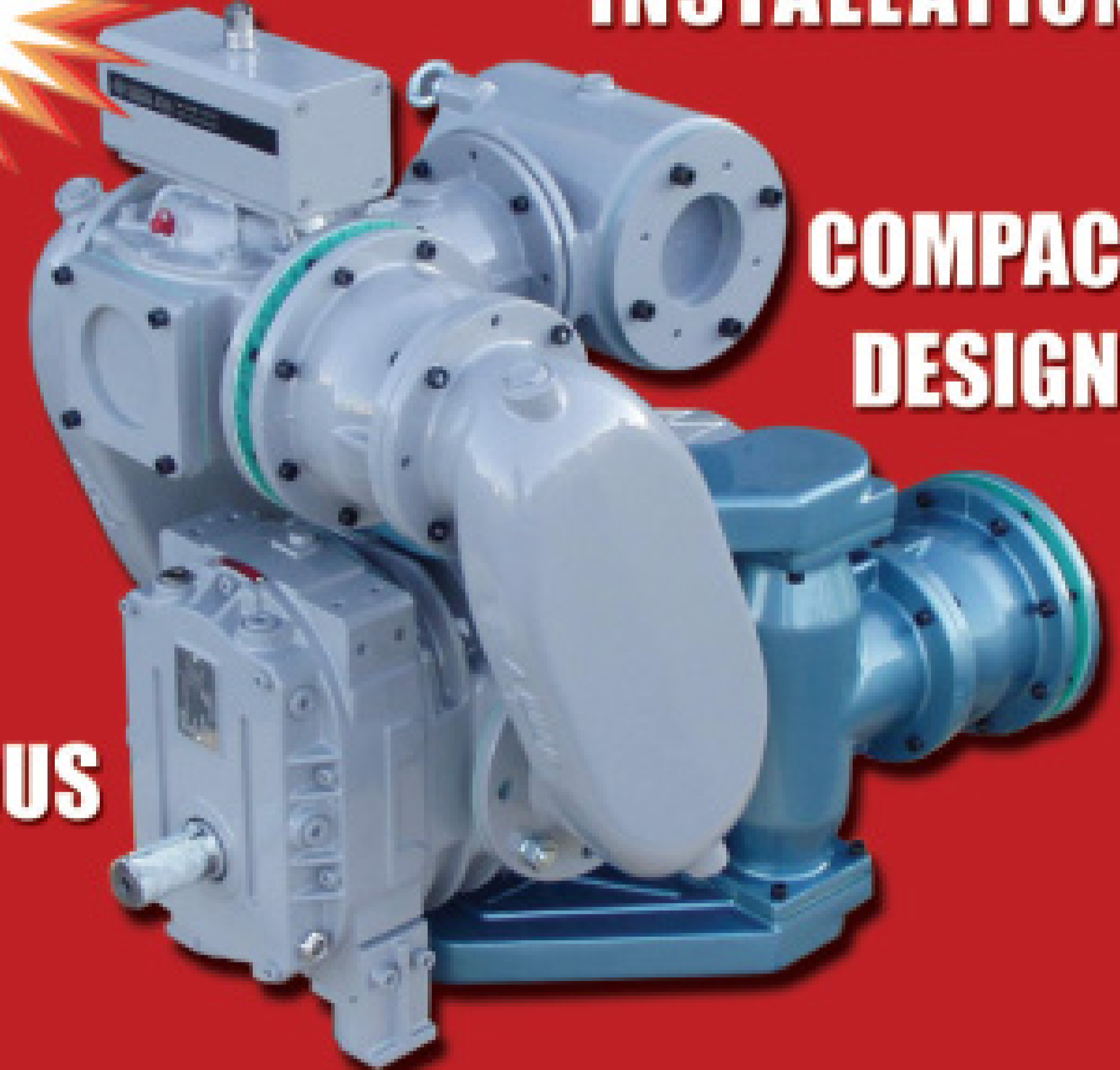

PVT200 TRI-LOBE BLOWER

Who Wins Auto vs. Manual Shift Debate at Your House?

By Jim Kneiszel, Editor

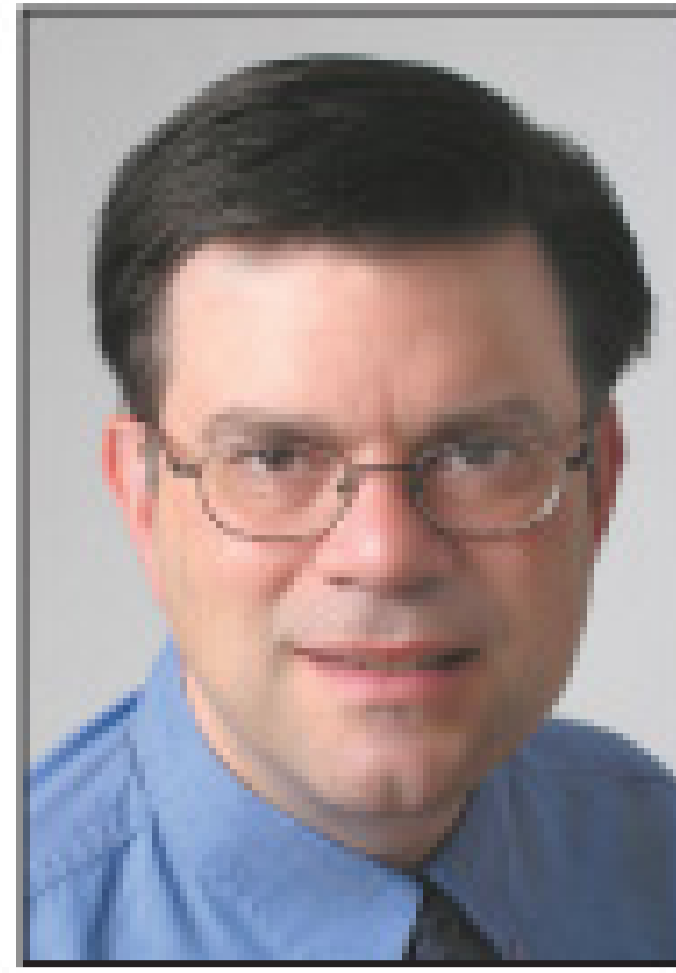

Recently my nuts and bolts discussion with pumper Greg Posch, owner of Tri-County Septic in Holdingford, Minn., turned to the automatic versus manual transmission debate.

Posch, featured in this issue ("Man of Steel"), was once a die-hard gear shifter who would never consider a truck with auto shift. In buying and rebuilding vacuum trucks over two decades, Posch wouldn't take a second glance at an automatic truck, no matter how clean its condition, how low its miles or how tempting its price.

That all changed when he bought a used Ford L8000 a few years ago, choosing the great deal despite the truck's automatic transmission. After working with the service rig during 2007, Posch's attitude about auto transmissions has shifted 180 degrees. Now he wouldn't buy anything else.

"I know they say you can lose the MPGs, but it's just so much nicer to drive," he says in a series of truck buying and building tips collected inside this issue. "Backing into yards, you can ease in there nice and slow and take your time."

The auto versus manual debate hits home with me, though not because I drive a big truck every day for my job. The closest experience I've had to Posch's daily ride was driving a moving truck with auto and one-ton pickups with stick shift. But auto versus stick is a frequent spousal debate at my home, as I assume it is in many homes where, typically, the man wants the stick and the woman wants the auto.

Interestingly, the issues are much the same whether you're talking about a truck with a 3,300-gallon waste tank or a 2,000-pound car. The argument comes down to mileage, reliability and convenience. If I say a stick shift would give us a few extra miles per gallon and would outlive an expensive automatic transmission in our family car, my wife thinks I'm silly and asks for proof.

Proof is hard to come by. When I look back at all the modern-day automobiles I've owned since the 1970s, I've only had one transmission issue, and that was a clutch going out on a stick Ford truck at 50,000 miles. By contrast, my last two automatic Volvo station wagons went 170,000 miles; one I sold and the other I'm still driving.

How about the miles per gallon issue? Check out mileage comparisons at www.fueleconomy.gov. For 2007, a Chevrolet Silverado with a 6-cylinder engine is rated to get 16 city/21 highway MPGs, while the manual transmission model is rated at 16/23 MPGs. The government fuel economy guide estimates the manual transmission will save \$170 annually on average. A 2007 six-cylinder Honda Accord with auto is rated at 18/26, while the stick shift version is rated at 18/27, with an annual fuel cost that's a draw between the two transmissions.

According to the Web site, other advanced technologies bring greater fuel savings than a standard transmission. They include variable valve timing and lift, cylinder deactivation and direct fuel injection. And in gearing technologies, thrifty new continuously variable and automatic manual transmissions have seemed to render the debate obsolete.

In the end, my wife — and perhaps the wives of many other manual transmission fans in the pumper world — argues for the convenience of an automatic transmission. And she always wins this one. ■

Contact us: Pumper strives to serve the liquid waste industry with interesting and helpful stories. We welcome your comments, questions and column suggestions and promise a prompt reply to all reader contacts. Call 800/257-7222; fax 715/546-3786; e-mail Pumper editor Jim Kneiszel at editor@pumper.com.

WHEN YOU REALLY NEED A WORK TRUCK NOW!

1-800-822-8785

www.fssolutionsgroup.com



ID #12145, 2006 Vactor 2112, High Dump, Tele Boom, Dual Stage Fan
NICELY EQUIPPED!



ID #71134, 2000 Vactor 2110, Roots 824 Blower, Automatic Transmission
NICELY EQUIPPED!



ID #85085, 2005 Guzzler CL, 1024 16" Vacuum, Hydraulic boom and vibrator
READY TO WORK!

Many More Units Available • Call for Details!

Parts and Service

Financing for Used Equipment and Service
Warranties for Most Equipment
We Sell and Service

The Largest Selection of Refurbished
Vacuum Trucks in the World



Top Line.



# of toilets	8	104
Standard price list	\$599.00	\$599.00
DISCOUNT PRICE	\$399.00	\$349.00
FREE DELIVERY		
<small>Continental US only.</small>		

LEONES

The new portable toilet TOP LINE: more durable, easier to handle and simpler to clean. With TOP LINE you get a high quality toilet at an unbeatable price and free delivery.



Walls do not have Armal logo.

Armal

www.armal.biz

Armal Inc. 122 Hudson Industrial Drive, Griffin, GA 30224 - USA
 Phone 770 491 6410 - Fax 770 491 9458 - Toll Free 866 873 7796
armal-inc@armal.biz

Scentbox.

LEONES

# of toilets	8	104
Standard price list	\$699. ⁰⁰	\$699. ⁰⁰
DISCOUNT PRICE	\$439.⁰⁰	\$389.⁰⁰
FREE DELIVERY <small>Continental US only.</small>		



International Patent Pending
PCT/IT2007/000700

The first portable toilet **with scented wall panels.**
Sturdy and easy to clean Scentbox is available in 5 fragrances and 5 new colors.



Strawberry Field **Apple Blossom** **Pinewood Trail** **Rose Sensation** **Vanilla Balm**

Walls do not have any graphics and Armal logo.

Armal

www.armal.biz

Armal Inc. 122 Hudson Industrial Drive, Griffin, GA 30224 - USA
Phone 770 491 6410 - Fax 770 491 9458 - Toll Free 866 873 7796
armal-inc@armal.biz

Mybox.

LEONES



# of toilets	104
Standard price list	\$799.00
DISCOUNT PRICE	\$499.00
FREE DELIVERY <small>Continental US only.</small>	

Now with MYBOX we **permanently customize the wall panels of your toilet** with graphics of your choice. Available in a large range of colors.



Armal

www.armal.biz

Armal Inc. 122 Hudson Industrial Drive, Griffin, GA 30224 - USA
Phone 770 491 6410 - Fax 770 491 9458 - Toll Free 866 873 7796
armal-inc@armal.biz



DRAGON

PRODUCTS, LTD.

PUMPS DIVISION

A Modern Group Company



Come see us at Booth S770



Custom fabrication to meet our customers specific needs in the Petrochemical, Shipping, Drilling, Agricultural and Mining industries. All Dragon pumps, agitators, hoppers and pump packages are assembled in Liberty, Texas.

All internal pump parts such as bearings, shafts, and mechanical seals are from the highest quality parts and materials made in the USA.

We maintain a huge warehouse of motors by Baldor and Reliance and starters by Sprecher & Schuh/Allen Bradley.

We also have a full stock of replacement parts for your pumps which are 100% interchangeable with other popular pumps on the market. Dragon is the largest stocking dealer of **Fruitland Pumps and Parts** in the U.S.A.



1-866-914-8198

email: sales@modernusa.com

website: www.modernusa.com



DRAGON

PRODUCTS, LTD.

A Modern Group Company

150 BBL ALUMINUM &
130-160 STEEL CODE
AND NON-CODE
VACUUM TRAILERS



30-80 BBL STEEL &
ALUMINUM BOBTAILS



SINGLE & TWO CONTAINER
ROLL-OFF TRAILERS



Come see us at Booth S770



500 BBL LIQUID TIGHT
SMOOTH WALL CONTAINERS

VACUUM
ROLL-OFF
CONTAINERS



Looking for Great Deals on Quality
Used Equipment.
Check out our web-site at:
www.modernusa.com

(877)778-4280

email: sales@modernusa.com



Ask about our easy
Credit Terms and
Convenient
Financing.

ABERNETHY

WELDING & REPAIR INC.

Vale, North Carolina 28168

Call Bill Abernethy at **1.800.545.0324**

Fax: 828.324.2401 • E-mail: abernethyinc@charterinternet.com

authorized distributor for:



www.abernethywelding.com

**2008's
Are Here!**

- International
- Ford • GM

2008 PETERBILT

2500 gal. tank, 2 with 6-spd.

2008 KENWORTH T300

2500 gal. tank, 6-spd., 260 hp

(2) 2008 INTERNATIONAL 4400

2500 gal. tank, (1) 6-spd. transmission & (1) auto transmission

NEW PORTABLE TOILET UNITS:

(2) 2008 INTERNATIONAL 4300s

1500 gal. portable toilet service units, auto transmission

2008 5500 CHEVROLET

1000 gal. 700 waste / 300 fresh, 2 Wheel Drive & 4 Wheel Drive available

2008 KENWORTH

1500 gal. portable toilet service unit, auto transmission

2008 PETERBILT

1500 gal. portable toilet service unit, auto transmission

WE WILL CUSTOM BUILD YOUR TANK UP TO 5000 GALLONS!

600-1500 Gallon Portable Toilet Trucks: Our Truck or Yours

SEVERAL GOOD, OLDER TRUCKS TO CHOOSE FROM:

- (2) 1995 Internationals
2500 gal. tank
- 1997 Volvo
4000 gal. tank
- 1998 Volvo
4000 gal. tank

PORTABLE TOILET UNITS:

- 2005 Chevrolet
1500 gal.
- 2000 Isuzu
800 gal.
- 1999 Freightliner
1500 gal.
- 1999 Sterling
1500 gal.
- 1991 4700 International
1400 gal. tank

**MANY OTHER
UNITS IN STOCK!**

**CALL FOR
UPDATE**



2008 International 4400E Series,
260 hp diesel DT 466 engine, 6-spd. trans. and world class auto, air brakes, 33,000 GVW, air conditioned, 2500 gal. tank, Masport HXL400 pump. **IMMEDIATE DELIVERY!**
Also, 2500 and 3500 gal. tanks **READY FOR IMMEDIATE DELIVERY.**



2008 International 4300,
220 hp DT466, Allison auto. trans., air brakes, 25,999 GVW, air conditioned, total tank capacity: 1100 waste/400 fresh, Masport HXL75V pump. **IMMEDIATE DELIVERY!** Also, 1500 gal. tanks **READY FOR IMMEDIATE DELIVERY.**

Check with us on financing for the purchase of a new truck!

COMPLETE PARTS AND IN-HOUSE SERVICE FOR:

AIC Vanes • Moro • Battioni • Jurop • Masport • Fruitland • NVE • Powerflo • Plus many other brands

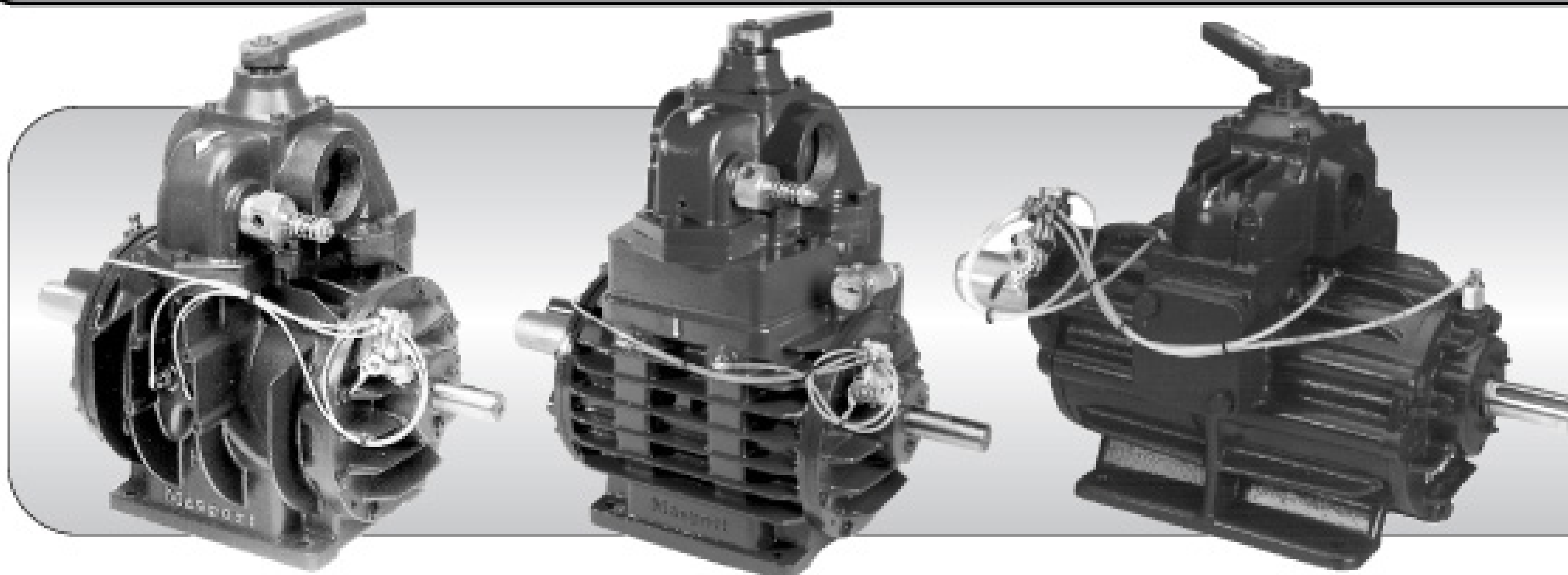

**Complete Line of
Masport Pumps
Available**

Immediate Delivery

OVERNIGHT DELIVERY ON PARTS • SAME DAY SHIPMENT ON PUMPS

WE SPECIALIZE IN PORTABLE SANITATION AND SEPTIC PUMPING EQUIPMENT

TEAR... SQUEEZE... ODOR'S GONE!

New!

Turbo Tubes make quick work of toilet tank odor.

What could be easier? Or more powerful? The concentrated power of Turbo Tubes handles the toughest odor in seconds. Now available in three strengths for use in all seasons and conditions. New Turbo Tubes make your job easier.

- ✓ **EASY to use:** Simply tear off the top and squeeze into the tank
- ✓ **EASY to deliver:** Moisture Guard package protects against accidental activation
- ✓ **EASY to ship:** Small, lightweight packages mean less freight charges
- ✓ **EASY to control:** Proportioned quantities insure proper use and less waste
- ✓ **EASY to buy:** Turbo Tubes cost less than other portioned-controlled products
- ✓ **EASY to store:** Turbo Tubes have a long shelf life and are simple to inventory
- ✓ **EASY to handle:** No bulky containers to handle, or bottles to fill
- ✓ **SAFE to use:** Turbo Tubes are people-friendly and earth-friendly. No carcinogens.

Green Way Products are always safe - always reliable - in all seasons, all the time.

**FREE
SAMPLE
PACK**

Try them for yourself. See how Turbo Tubes make your job easier. Simply call Cindy (or your area manager) for a free sample pack.

800-241-7951



POLYPORTABLES

Listening. Learning. Delivering. Since 1972

99 Crafton Drive, Dahlonega, GA 30533 USA
Phone (800) 241-7951 or (706) 864-3776 • Fax (706) 864-8111
www.polyportables.com



TOILET DEODORIZERS • TOILET CLEANERS • AIR FRESHENERS • INSECT REPELLANT

All Green Way deodorizers, cleaners and air fresheners are earth-friendly, people-friendly products. They are developed and manufactured in our facilities in Dahlonega, Georgia by Green Way Products, a PolyPortables sister company.

Patent Pending

the
Choice
 is yours

Get exactly what you want
 and need in a restroom
 trailer. ACSI gives you
 the options...

www.restroomtechnology.com
1-800-927-2271

You Can Do It!

Add a VacMate to your DOT vacuum truck for clean and vac capability

Start cleaning USTs with the Gamajet X and Gamajet's towable VacMate Cleaning System. By attaching the self-contained system to your existing DOT compliant vacuum truck, you can offer unrivaled cleaning capabilities. Take your water supply with you and powerfully clean any size UST, while using your vac truck to extract the waste.

The Gamajet X is the only way to put effective 360° rotary impingement power inside USTs for complete cleaning.

Powerful cleaning jets reach all areas of interior

GAMAJET[®]
 Gamajet Cleaning Systems, Inc.
 604 Jeffers Circle, Exton, PA 19341
1-877-426-2538
www.gamajet.com

The Gamajet VacMate Cleaning System also makes decommissioning and inspection easier and safer!

**Post Show
Specials**



VACUUM SALES, INC.

51 STONE RD. • LINDENWOLD, NJ 08021

Low Interest Rate Financing Available!



Stock # 4648V 2003 Sterling Model LT9513 Cab & Chassis with a Vac-Con Model VPD4216LHA/1300 combination vacuum loader & high pressure sewer cleaning system. Less than 95,000 miles. **\$169,000**



Stock # 13234 Pipehunter Truck mounted jetting unit, 3,000 psi at 50 gpm with a 1,000 U.S. gallons water tank, rear mounted hose reel with a Jet Eye Camera system mounted on a 2006 GMC TC6500 cab & chassis. Less than 6,000 miles. **\$179,000**



Stock # 13297 2008 Peterbilt 340 with a new Presvac 3,600 gallons (US), aluminum vacuum tank unit. **\$126,000** Includes F.E.T.



Stock # 13294A 2008 Sterling LT9500 with a New Presvac 3,500 gallon c/s DOT certified 407/412 vacuum tank dump type with full open rear door. Presvac PVB750 vacuum pressure pump. **\$305,000** Includes F.E.T.



Stock # 13329V 2001 Freightliner C120 cab and chassis with a NEW Presvac 3,200 gallon DOT 407/412 Certified Vacuum -pressure tank. **\$115,000** Includes F.E.T.



Stock # 13273 A & B 2007 New Acro Trailer 7,000 U.S. gallon aluminum vacuum pressure tank. **\$169,000**



Stock # 5008V 1990 Presvac 5,000 stainless steel D.O.T. with pump & engine. **\$72,000**



Stock # 13289 2007 Chevy C7500 cab & chassis W/ a New 1500 waste & 500 water aluminum portable. **\$78,000**

Sales, Parts & Service

888.VAC.UNIT

(888.822.8648)

www.VacuumSalesInc.com

Corralling Insurance Costs

Higher deductibles, safety programs and security measures help control rising business insurance costs

By David Wall

I am sure you have noticed insurance rates going through the roof for portable restroom operators over the last three years. A lot of explanations have been circulating to explain why this is happening. Rumors have said it was due to the expense of insuring against terrorist attacks since 9/11. Others have guessed it was a result of unusual weather patterns that have brought more hurricanes to the South as well as mudslides and wildfires in the West. While these occurrences have certainly had a minor effect, the biggest reason for rate increases was much simpler.

According to Mark Herring of Heffernan Insurance Group, rates have been going up because insurance companies lose money when the stock market takes a nosedive. To see why a dropping market drives rates up, you have to understand how the insurance business works.

Insurance companies collect premiums from customers all over the country, but they don't just hold this money waiting to pay claims. They invest it widely, in bonds, stocks, real estate, etc. When not paying claims, the money grows. That growth is what fuels their profits. During the late 1990s, when investments were achieving double-digit growth, insurance companies were so profitable they actually provided insurance coverage at less than their own cost to keep the premiums coming in to fuel their investments.

However, after the stock market tanked and interest rates on bonds dropped to near record

lows, insurers were forced to raise rates to recoup double-digit losses in their investments. What's more, since their investments were losing, they couldn't offer insurance below cost and needed to raise rates to profitable levels. Natural disasters and terrorists haven't helped the matter, but the driving force on rates has been a stock market decline.

Of course, this good news doesn't help pay the bills today. So, we asked Herring what companies can do to keep rates under control during good and bad times. Here's his advice:

RAISE YOUR DEDUCTIBLE AND PLAN TO PAY AFFORDABLE LOSSES

"The number one thing you can do is to raise your deductible. The fender benders, equipment damage, and petty theft that happen in all businesses are better paid out of pocket," Herring says.

"I advise my clients that if they really want to lower their premiums and keep them low, they should consider a \$5,000 deductible and think twice before filing a claim."

Why should you carry insurance if you are not going to use it? Obviously, it will be there when you really need it to save your business if an employee is seriously injured on the job, if a truck is totaled, if a tornado, fire, or hurricane destroys your building or wipes out your fleet, or if you get hit by a lawsuit — frivolous or otherwise.

Paying the affordable losses yourself accomplishes several positive things: It keeps insurance rates as low as possible for

your business. It gives you a tax write-off, since losses are fully deductible. It forces you to think hard about minimizing losses since they come out of your pocket.

MINIMIZE YOUR COMPANY'S LOSSES

Accidents happen. However, a carefree attitude isn't good for your business or your insurance rates. There are several things you can do to reduce your business insurance claims, including:

- Lock down equipment at night to prevent theft. Bolt locks should be used on all doors. Hitch locks should be used on rolling assets like flatbed trailers.
- Put break-in alarms and fire alarms in buildings.
- Ask customers to sign damage waivers to help defray the costs of damage done on the job.
- Try to hire only employees with safe driving records.
- Create disincentives for speeding or driving without seat belts, such as work suspensions for traffic tickets.
- Award safety bonuses to drivers who go a year without an accident.

David Wall is northwest area manager for PolyJohn Enterprises of Whiting, Ind. He can be reached at david.wall@polyjohn.com



- Don't skimp on truck maintenance, especially brakes and tires.

- Train new drivers thoroughly so they are skilled in driving with large fluid tanks.

- Spend extra time teaching about the danger of rollovers, and stopping on slippery pavement.

- Encourage drivers to pull over when using cell phones or radios.

- Require rubber gloves and non-skid boots.

- Encourage drivers to use antiseptic hand cleaner in their trucks.

- Provide training in the proper handling of all hazardous materials including tank deodorizers, methanol and untreated sewage spills.

- Start a safety program that includes lessons in proper lifting techniques, how and when to use hardhats, how to avoid falls and injuries from falling equipment.

The next time you shop for business insurance get at least three quotes, and look for insurers who know the specifics of your business. You don't want to end up insuring a "dump" truck, when you said "pump" truck. ■

Everyone's talking about it.

Find out why.
Get your **FREE** subscription today.

ONSITE
installer

PROMOTING WASTEWATER TREATMENT
QUALITY AND PROFESSIONAL EXCELLENCE

Visit www.onsiteinstaller.com or call 800-257-7222.

READY FOR IMMEDIATE DELIVERY
CALL US TOLL-FREE: 877-296-2555



2007 Sterling LT9500, MBE 450 HP, 10-speed, 20,000 front, 46,000 rear, compression brake, cruise, PS/AC

4200-gallon 2-chamber (4000 septic, 200 fresh) PROGRESS aluminum tank with a full rear-opening door and a hoist.

NVE 506 4-inch pump 500CFM and jetter, 10 gpm, 2400 psi

Price **\$150,000** + F.E.T.

2001 International 4900, DT466, 210 HP, 33,000 GVW, 7-speed, 236,000 miles
NEW 2300 gallon carbon steel tank with 3-inch inlet, 4-inch outlet, rear and top manways
NEW MEC 8000 Battioni pump (242 CFM), gearbox driven, air PTO
 Price**\$42,900**

In Stock

IN STOCK
28-foot black Portable Toilet Trailer holds 14 units. Includes two 3500 GVW Torflex axles. 80-inch rear fold-down center T-bar to accommodate a handicap unit.
 Price**\$8,438**

Used Unit

1995 Ford CF 8000 new engine in 2004, 92,000 miles, PS/rebuilt transmission, new paint, 75% tires 2500-gallon 2-chamber tank, (300 fresh/2200 waste), built in 2000 MEC8000 vacuum pump, 240 CFM. Set up to service portable toilets and septic tanks
 Price:.....**\$28,600**

SPRING MOUNTS decrease fatigue on your tank frame, universally mounts to most tanks, Easy bolt or weld on style, Compact, Heavy-duty stress relieved springs.

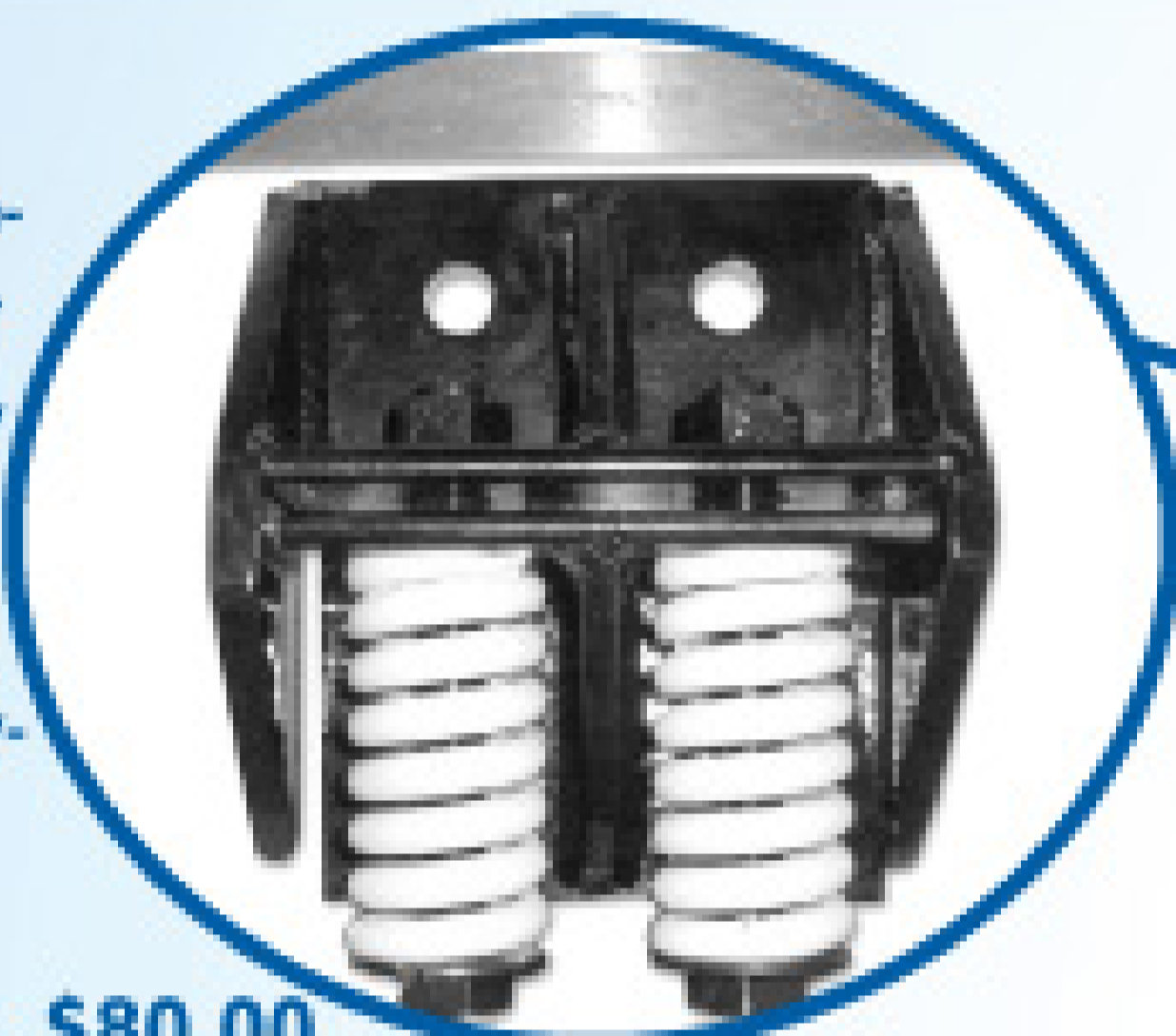

Mounts with springs..\$80.00
Springs alone\$10.00 each

Wee Vac
 No more 3" sewer hoses running through restaurants. The Wee Vac fits through a standard doorway and can pump up to 45 gallons at a time. Wee Vac will even go up and down stairs when empty. It has a 3" female camlock so it can be downloaded into your truck. It features a 1 1/2" hose with wand & a 105 cfm, 110 volt vacuum pump.
Price: \$1060.00



WE

Wee Engineer
 WITH IMAGINATION

Thank You

Thank you, **John W. Clanton, Jr. of A-1 Septic Cleaning Service** for purchasing this 1999 International 9100. We equipped it with a new 2500-gallon carbon steel tank and a new NVE 367 Challenger pump system.

Thank You

Thanks to **Phil Frasier of Frasier's Plumbing and Heating** for purchasing this 2005 Ford 550 with an 850-gallon aluminum 2-chamber tank, MEC2000 vacuum pump, and an 8-HP Honda 5 gpm demand pump.

Add **Heated Collars** to your vacuum tank to help prevent the valves freezing. Many of our customers in the northern latitudes find that making a profit during the winter months is much easier with the installation of heated collars on their vacuum tank. The collars are both designed and built by Wee Engineer.

1 1/2 or 2 inch .. \$105.00	6 inch\$283.00
3 inch \$157.00	Installation Kit (no hose) ...\$76.50
4 inch \$189.00	110 V Heater Kit\$160.00



P.O. Box 39 Dayton, IN 47941 Toll-Free: 877-296-2555 Phone: 765-296-2027 Fax: 765-296-3027
www.wee-engineer.com

chempace[®]

corporation

www.chempace.com

Serving the Industry for Over 40 Years!

One-Stop-Solutions For PORTABLE SANITATION & SEPTIC & GREASE HAULERS

**BUYING DIRECT
ALWAYS EQUALS
COST SAVINGS**

Big Shot[®] Con2 & Con2 Plus

- Super Strength Concentrate
- Non-Formaldehyde
- Ideal for Summer Use

**NEW
FEATURES
ON 3 GREAT
PRODUCTS!**

**NEW
FORMULA!**

**ENHANCED
FRAGRANCE!**

**STRONGER
DYE**

Ultra PowrPak XL

Convenient Carry Pail
Effervescence

**MARCH
SPECIAL**

**SEPTIC TANK
ADDITIVES \$6** (Per Pkg)

**LONG
LASTING
PINK CUBE
\$160** (Per 4x5 lbs.)

*Designed to last in
hard to service
liftstations/grease traps*

**NEW
PACKAGING
OPTION**

**CALL FOR
OTHER MARCH
SPECIALS**

SEWER FOAM \$59.75 (Per Pail)

*Reduce solids and hydrogen sulfide odors -
Economical approach to sewer maintenance.*

**BUY DIRECT CALL CHEMPACE
1-800-423-5350**

**Clearly,
A Good Idea!**



NoConcepts

**Solar Powered, Self-Contained,
Special Event Restrooms**

www.nuconcepts.com

800-334-1065



IF YOU PUMP GREASE OR UNPERMITTED WASTEWATER INTO SEWERS, YOU WILL BE PROSECUTED FOR A FELONY.

My name is Ralph Rogers, and I am the President of Ecosolve LLC, in Charlotte North Carolina. Ecosolve contracts with restaurants and other businesses in Charlotte and other Southern cities. Those businesses are required to remove the grease and other wastes from grease traps to ensure the waste does not go into the sewer system and risk causing serious blockages and backups.

Recently, I, my company, and other employees, plead guilty to a federal violation of the Clean Water Act. More specifically, this violation involved the illegal disposal of wastewater (gray water) that had been removed from customer grease traps but re-introduced back into the grease traps and then eventually into the Charlotte Mecklenburg sewer system.

As part of the plea agreement, my company and I agreed to the following:

- 1) Plead guilty to a federal felony that carry substantial penalties;
- 2) Improve the environmental compliance plan at Ecosolve to reduce the likelihood of future environmental violations;
- 3) Publish this public apology.

I deeply regret that these environmental violations occurred on my watch. We have taken all steps necessary to insure that all such conduct will be prevented and detected in the future and that all federal laws will be respected. We sincerely hope that other environmental service companies and owners will learn from our experience and will take the steps necessary to improve compliance and prevent environmental violations.

Ralph Rogers

T **RANSWAY** *SYSTEMS INC.* **PROFESSIONAL VACUUM EQUIPMENT**

Toll-Free: 800-263-4508

DELIVERY SERVICE
AVAILABLE

T: 905-578-1000

F: 905-561-9176

314 Lake Ave. North
Hamilton, Ontario L8E 3A2

WE PAY BORDER CROSSING CHARGES • LEASING? WE CAN REFER YOU TO THE SPECIALISTS • OVER 40 YEARS IN BUSINESS

HEAVY-DUTY EQUIPMENT THAT WORKS!

**LET 45 YEARS
OF EXPERIENCE
WORK FOR YOU !**



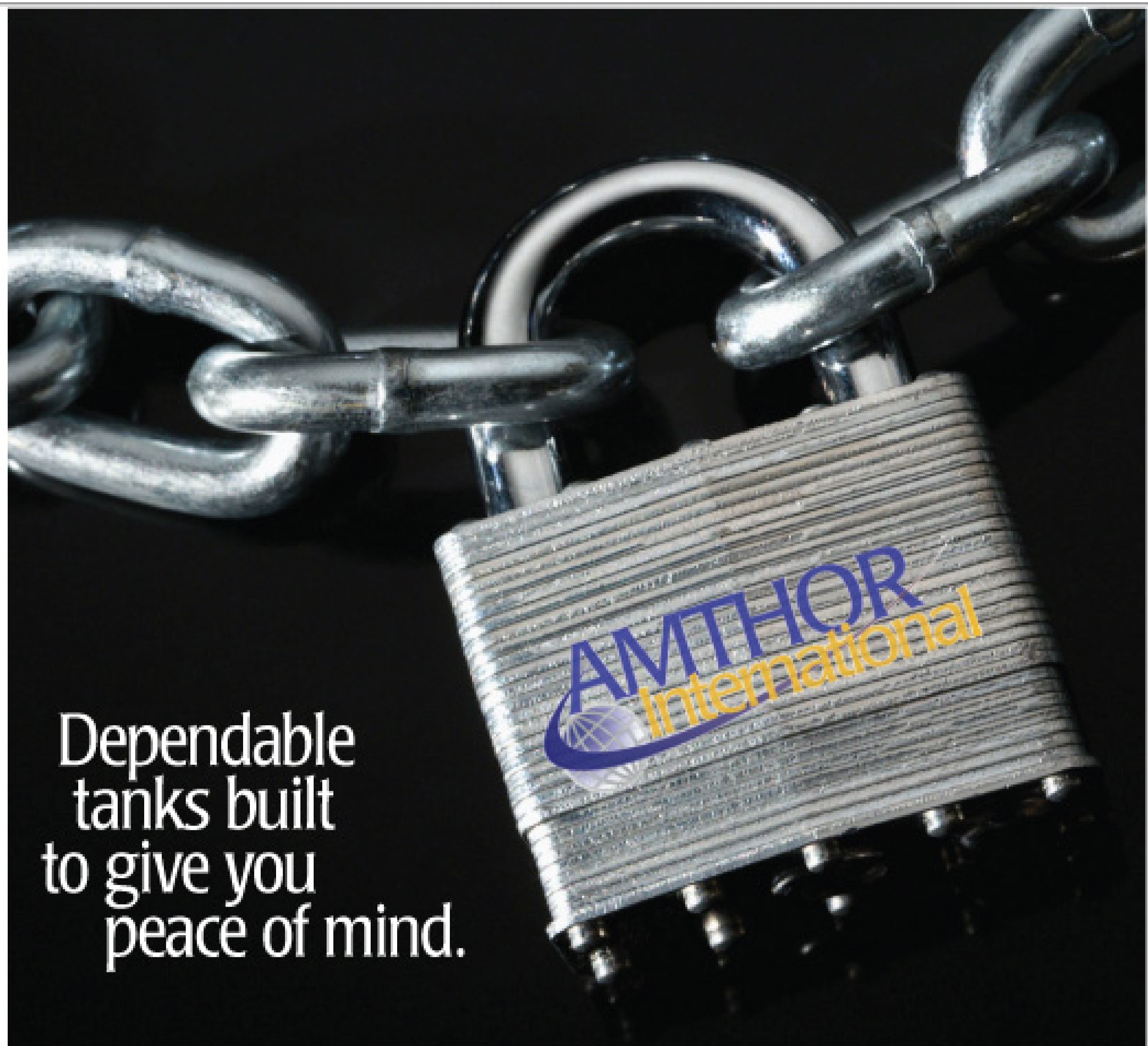

Dependable tanks built to give you peace of mind.

Amthor is Security

Looking for a new tank? Think Amthor. At Amthor, we deserve our reputation for quality, innovation and expertise. Our products meet the demands of today's consumer AND exceed industry expectations. With a nationwide distribution network, delivery is simplified. Plus, you'll enjoy exceptional customer service. Visit us online for specific product information.



www.AmthorInternational.com
 For your nearest distributor contact: Hank Vanderveen
 VA Office: 434.656.6233 • Tel/Fax: 252.293.1284 • Cell: 845.494.0104

PUT THE SQUEEZE ON WET WASTE ...
 With Belt Filter Press Dewatering



Rentals Skid Systems Mobile Units



Made in the USA

Touch Screen Controls
 Highest Dewatering Throughputs available
 Stainless Steel Construction on Frame, Rollers and pans

Grease Trap Waste Septage Waste Industrial Waste

Toll Free: 800-253-0532
 Phone: 269-793-7183 Fax: 269-793-8793
 127 N. Water St., Hopkins, MI 49328

Contact: Julie VanderMoore at
julie@brightbeltpress.com
 269-793-3423
www.brightbeltpress.com

THE BEST SOFTWARE FOR YOUR COMPANY

THE SAFE PROGRAM

Service Pumping Rentals

Schedule Inspections
 Route Technicians
 Create Invoices
 Utilize Mapping
 Print Reminders

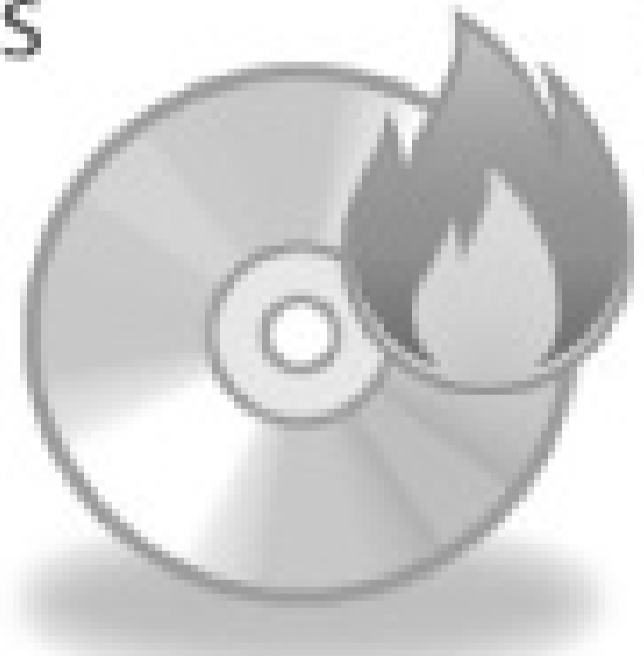

Create Spreadsheets
 Internet MapLinks
 GPS Coordinates
 Word Documents
 On-Screen Listings

\$1000 Purchase Price!
 Unlimited Installations and Licences
 Easy Backup and Network
 Excellent Customer Service and Support
 Call for a FREE TRIAL (940) 367-2246
 Or go to www.thesafeprogram.com

Experience the raw power of...

SURCO®

BLUE • MUSCLE™

THE MOST POWERFUL PORTABLE TOILET DEODORANT IN THE INDUSTRY

Stock up and Order Today!

1-800-556-0111

or on the web at:

www.surcopt.com



SURCO®

– Since 1946 –

292 Alpha Drive • Pittsburgh PA 15238

1-800-556-0111 412-252-7000

www.surcopt.com



©2008 SP

7000 Gallon Aluminum



Manufacturing

- *Stainless Steel*
- *Aluminum*
- *Code & Non-Code*

800-589-5254

ACRO
Trailer Company

Vacuum Trailers for the
Liquid Transportation Industry

Parts • Repair • Complete Pumping Systems

www.acrotrailer.com • 417.862.1758 • fax 417.862.8084 • 2320 North Packer Road • Springfield, Missouri 65803

LIBERTY PUMPS



Omnivore LSG 200
Residential Grinder

We Carry a
Full Line of
**LIBERTY
PUMPS**
which come with
a **2-year**
warranty



280-Series Mid-Range
Effluent Pump

Thanks for visiting us
in Louisville!



Regenair®
R3105-12
Blower
\$410

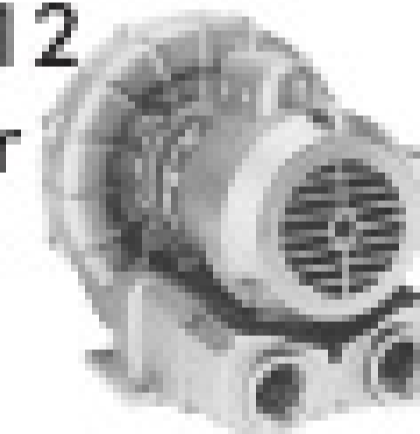

Hydromatic,
Zoeller, ABS,
Liberty &
Myers
Pumps



Sutorbilt & Roots
Blowers



SDS
From 70-180 cfm



Heavy-Duty
DC-STAINLESS
Washdown Pump



Moro PM80
Turbo 350 cfm



Moro
M3
176 cfm



Moro
M-10
230 cfm



Moro Pumps: from 176 to 1642 cfm

Flagg-Air Model 340

\$325

- 3450 rpm
- 1/4 hp, 115V
- Enclosed motor
- Stainless steel shaft
- High impact plastic parts
- Operates quietly
- 2-yr. warranty
- Fits in place of most original manufacturers' units
- Replacement parts available



The Flagg-Air 340 does not carry the NSF seal. Check local and state regulations for approval in your area.

LA-60B \$275
LA-80B \$300
LA-100B \$445
MEDO
Piston



SECOH Diaphragm
EL 60 \$255
EL 80 \$300



0523
Rotary Vane
Compressor
\$310



Septic Services, Inc. toll free 1.800.536.5564 • 636.583.5564 • fax 636.583.6432
e-mail septic@fidnet.com • web www.septicserv.com



WANTED
FOR EXCESSIVE QUALITY!



Have you seen this trailer?



Call (800) 815-2557 or
visit jagmobilesolutions.com

REWARD!



Thanks for visiting us!

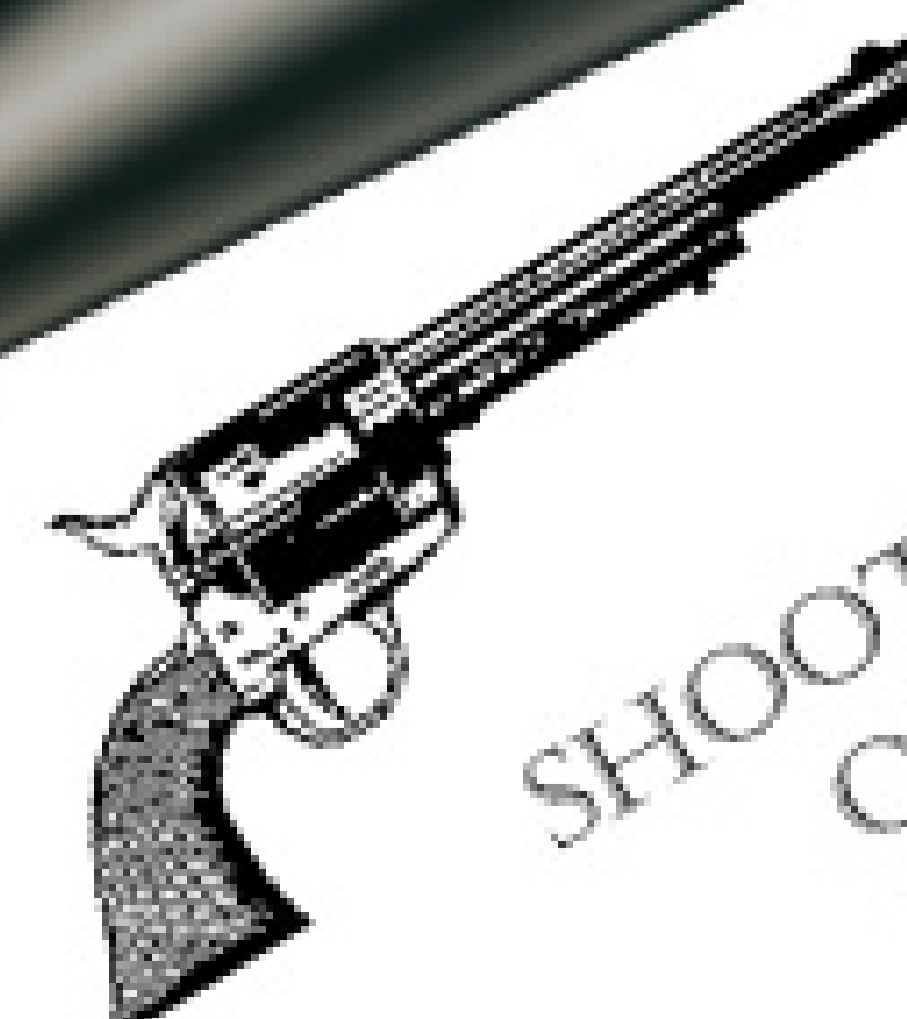

SHOOT OVER TO
OUR NEW
WEBSITE!

Agitation SAVES Aggravation!



CHECK OUT OUR
NEW VIDEO
PUMPER.COM/VIDEO.PHP

The Ultimate hand-held, powered agitator for septic tanks, grease traps and car wash pits

Saves Wear and tear on vacuum pump and equipment

Ergonomic shape and light weight helps to save your back

Extensions come in 2', 4' or 6' lengths

Mixes a 2000 gallon tank in less than 5 minutes

BE SURE TO
REQUEST A
FREE
INFORMATIONAL
DVD!

ASK ABOUT OUR **"BUSTER BRACKETS"** FOR TRUCK MOUNTING

"As the owners of 2 of your CrustBuster machines, we are happy to say they are the best investments we have made since we started our business. The days of back flushing, using a rake or a 2x4 for cleaning the tank are "Old School"."

— **Don & Dawn Long, American Septic Service**

CRUST BUSTERS



Schmitz Brothers L.L.C.
PHONE 763.878.2296
FAX 763.878.2299

E-MAIL pete@crustbusters.com
WEB SITE www.crustbusters.com

1.888.878.2296

CUSTOM SIGNS AND DECALS

United
SITE SERVICES
877-340-0004
800-638-1233

(800) 446-4689
A-Throne
Lawn Care Industry

Another...
**ANDY GUMP
FENCE**
1-888-263-9486

Diamond
environmental services
1-888-744-7191

**TROJAN
PORTABLE
SERVICES**
1-800-427-3673

HAULAWAY
800-222-3337
haulaway.com

All Of Our Custom Manufactured Products
Are Quality Engineered For Long Term
Outdoor Durability.

- Very Competitive Pricing
- Knowledgeable, Helpful And Courteous Customer Service Staff.
- Dependable Delivery.
- Digital Print And Vinyl Cut Lettering
- Generic Signs And Decals

And Much More!

DURABLE, AFFORDABLE AND BUILT TO LAST
SINCE 1949

J.C. Gury Company Inc.

530 East Jamie Ave, La Habra, CA 90631 Call (800) 903-3385 or (800) 556-5576
www.jcgury.com

H&M

**Vacuum Pumps
& Equipment, Inc.**

Toll Free: **800-533-5858**
www.hmvacuumumps.com



**ONLY THE FINEST
PRODUCT LINES!**

CHALLENGER • CHANDLER • CONDE • JUROP • MORO • NVE • ROBUSCHI • THOMPSON TANK • UTILE

PROVIDING SERVICE WORLDWIDE - CALL TODAY!



"Built to do the work for you."



SOLD

(1) - 2001 International 8100, ISM Cummins
(280 HP), 67K miles, 10 spd. Trans., 76" dia.,
3,000 gal., 1/4" Shell, Full Tilt/Open, 4" intake,
RCF Fruitland 500 pump

◆ (1) - 2008 Peterbilt 340 with a PX 8 330 HP and
a 10 spd. Eaton-Fuller transmission, 76" dia.,
3,150 gal., 5/16" Shell, Full Tilt/Open, 4" intake,
6" discharge, RCF Fruitland 500 pump

SOLD



SOLD

(1) - 2001 International 9100, N14 Cummins
370/425 hp, 70K miles, 10 spd. Trans.,
76" dia., 3,000 gal., 1/4" Shell, Full Tilt/Open,
4" intake, 6" discharge, RCF Fruitland 500 pump

Call Now To Order

ASME DOT 407/412 CODE UNITS

Mounted on a new or used Peterbilt, International or Freightliner

- ◆ (1) - 76" dia., 3,150 gal., 5/16" Shell, Full Tilt/Open, ready to be mounted*
- ◆ (1) - 76" dia., 3,150 gal., 1/4" Shell, Full Tilt/Open, ready to be mounted*
- ◆ (1) - 76" dia., 3,000 gal., 5/16" Shell, Full



Tilt/Open, ready to be mounted*

- ◆ (2) - 72" dia., 3,150 gal., 1/4" Shell, Full Tilt/Open, ready to be mounted*
- ◆ (2) - 76" dia., 3,000 gal., 1/4" Shell, Full Tilt/Open, ready to be mounted*

Call for quotes

* Tanks can be shipped.

MANUFACTURER OF DOT 407/412 TANKS

For more information
contact L.C. Sutton



Global Vacuum Systems, Inc.

32804 US 290 West
Hockley, TX 77447

Toll Free: 800-843-0866

Email: info@globalvacuumsystems.com

Web: www.globalvacuumsystems.com

Long-Delayed California Rules are Back on Track

By Doug Day

California continues to move toward implementation of long-delayed onsite wastewater rules. The regulations are driven by Assembly Bill 885, passed in 2000 to establish a process for developing standard, statewide performance standards for onsite systems.

The original deadline for the regulations was Jan. 1, 2004. Budget cuts and controversy have delayed the work. The State Water Resources Control Board published the following schedule leading up to full implementation in November.

- Dec. 1-Feb. 15: Draft responses to public comments.
- Feb. 15-April 1: Final comment period followed by adoption.

- April 1-May 1: Record review by Office of Administrative Law.
- May 1: Rule becomes effective.
- November: Implementation.

ALABAMA

The Alabama Onsite Wastewater Board has adopted changes to onsite treatment regulations. The changes include record-keeping requirements affecting both tank manufacturers and pumping contractors. A copy of the new regulations is available from the Bureau of Environmental Services at 334/206-5373.

There has also been a change in the licensing requirement for

septic tank manufacturers, installers, and maintenance companies that allows them to meet the licensing requirements by hiring a licensed subcontractor. A copy of those new rules is available by calling 888/737-2162.

FLORIDA

The state Department of Environmental Protection's updated fee structure took effect last September. The largest increase is for an application to use an "innovative product." That fee increased from \$500 to \$2,500.

"Innovative system" means an onsite sewage treatment and disposal system that, in whole or in part, employs materials, devices, or techniques that are novel or unique and that have not been successfully field-tested under sound scientific and engineering principles under climatic and soil conditions found in Florida.

The application fee for a plan review or construction permit for a new system increased from \$50 to \$100, while the cost for an amendment to an operating permit was reduced from \$75 to \$50. The cost of variances increased from \$150 to \$200 for single-family homes, and from \$200 to \$300 for multi-family and commercial buildings.

ILLINOIS

The state Department of Public Works is proposing changes to the rules governing maintenance and inspection of private sewage disposal systems. The new rules were published last November for public comment and can be found at www.idph.state.il.us/rulesregs/

"Rules and Regs" is a monthly feature in Pumper. We welcome information about state or local regulations of potential broad interest to onsite contractors. Send ideas to editor@pumper.com.

proposedrules.htm.

The changes affect many sections of the regulations, including requiring suitable soils for subsurface seepage systems and clarifying the department's ability to approve technology tested by other government agencies. The rules update the requirements for contractors, spell out consequences for failing to attend examinations, and address many design criteria such as the sizing of chambers, sample ports and reduction trenches.

MINNESOTA

The Minnesota Pollution Control Agency has published final language for new rules governing subsurface sewage treatment systems, or SSTS. The rules were scheduled to take effect on Feb. 19. The changes can be seen on the agency's Web site at www.pca.state.mn.us/programs/ists/index.html.

In addition, the state has formed an SSTS Licensing Stakeholder Task Force to develop clear guidelines for licensing qualifications. The state legislature called for the task force to report back by Feb. 15.

The group is looking at "professional qualifications and appropriate licensure for design, inspection, and operation and maintenance of sewage treatment systems less than 10,000 gallons of wastewater flow per day," according to the group's Scope Statement. More information is available at www.pca.state.mn.us/programs/ists/news.html. ■

RABCO 800-2-DRAINS

<div style="background-color: #006633; color: white; padding: 2px; font-weight: bold;">Hose Hook</div> <p style="font-size: 0.8em; color: #006633;"><i>Safer, Easier Way to Pick Up Suction Hoses!</i></p>	<div style="background-color: #006633; color: white; padding: 2px; font-weight: bold;">Waste Water Analysis</div> <div style="display: flex; justify-content: space-between;"> <div style="width: 45%;"> <div style="background-color: #006633; color: white; padding: 2px; font-size: 0.7em; font-weight: bold;">pH Meters</div> </div> <div style="width: 45%;"> <div style="background-color: #006633; color: white; padding: 2px; font-size: 0.7em; font-weight: bold;">Dissolved Oxygen</div> </div> </div> <div style="display: flex; justify-content: center; margin-top: 5px;"> <div style="background-color: #006633; color: white; padding: 2px; font-size: 0.7em; font-weight: bold;">Multiparameter</div> </div> <div style="display: flex; justify-content: space-around; margin-top: 5px;"> <div style="background-color: #006633; color: white; padding: 2px; font-size: 0.7em; font-weight: bold;">BOD</div> <div style="background-color: #006633; color: white; padding: 2px; font-size: 0.7em; font-weight: bold;">Free & Total Chlorine</div> </div>
<div style="background-color: #006633; color: white; padding: 2px; font-weight: bold;">Sludge Judge™ Tank Samplers</div> <p style="font-size: 0.8em; color: #006633;"><i>Accurate Readings of Settled Solids in a Variety of Liquids.</i></p>	<div style="background-color: #006633; color: white; padding: 2px; font-weight: bold;">Soil Samplers</div> <p style="font-size: 0.8em; color: #006633;"><i>3/4" Dia x 6.5" Long Stainless Steel Cylinder Carbon Steel Bits. Rubber Coated Cross Handle Stelite Hard Surfaced Cutting Edges</i></p>
<div style="background-color: #006633; color: white; padding: 2px; font-weight: bold;">Extend-A-Vue™</div> <p style="font-size: 0.8em; color: #006633;"><i>Safely Inspect Septic Tanks, Manholes Confined Spaces!</i></p> <p style="font-size: 0.8em; color: #006633;"><i>Acrylic Mirror Light Kit Swivel Mirror Telescoping Poles</i></p>	

PumperSupply.com

RABCO

Tel: 203-230-1693 · 800-237-2467
Fax: 203-230-2956 · 800-332-3335

Factory Built-Work-Ready IN STOCK Selection of *progress tank* Vacuum Service Truck Tanks

NEW! Mid Range - 22,000 GVW-2008 Kenworth T300

Cummins diesel, Allison automatic, Hydraulic brakes,
Air Conditioned, AM/FM, Air suspension drivers seat,

1700 Gallon *PROTAVAC* Restroom Service

400 fresh / 1300 waste Masport HXL 4 Vac pump
w/ pre-filter, Burks DC 10 wash down, Hot shift PTO
w/ remote, 4" discharge, unit hauler and tow package.

\$75,100

Lease from **\$1030.** mo.

Unit # 1271



NOW IN STOCK!

New from *progress tank* SLIDE-IN VAC UNITS

300 Waste / 135 Fresh
Masport or Conde pump
Honda electric start
12 volt water pump

Totally self contained!

\$8,500

 M.S.R.P
Unit # 4638

Unit # 1346

1250 Gallon Restroom Service

Masport HXL4, Burks DC10, P.T.O.

2008 Sterling Bullet - 20,500 GVW

Cummins 305 HP, / Auto. transmission

\$68,500

Monthly lease from **\$1,370**



EQUIPMENT & SUPPLY CO INC.

1-800-392-3513

www.excel-equipment.com

Tel: 317-882-1300 Fax: 317-889-0052
585 Sayre Court, Greenwood, IN 46143

Unit #1124

800 Gallon Combo Unit

10' Bed with Liftgate Dual Service

2007 Ford 550 XLT Upgraded interior,
power windows, locks and mirrors.

\$72,230

Monthly lease
from **\$1,446**



Unit # 1303

4200 Septic Tank

Masport HXL400 water cooled.

2007 Sterling 9500

58,000 G.V.W.,
410/450 HP, 10 speed

\$129,000

Plus FET

Monthly lease from **\$2,580**





We Have Financing Available!



2007 Sterling 2500 gallon Steel
Jurop pump, Mercedes 260 HP, 10 spd,
engine brake, Traction control
ALUMINUM HOSE TRAYS.

\$77,500 Plus FET

Now In **STOCK!**

On-The-Lot Selection *Call For Prices & Pre -Approval!*



2007 Sterling AUTO TRANS 4000 gallon
steel tank, Jurop pump, Cat 330HP,
Allison auto 18K ft, 40K rear exhaust
brake, ALUMINUM TRAYS.

\$102,000 Plus FET



2007 Sterling AUTO TRANS 2500/300
Gallon Aluminum, PM80 pump Cat 275HP,
Allison Auto, Exhaust brake, Traction Control.

\$92,000

Call Us Today Toll-Free:
888-201-9166

Septic - Portable Toilet - Hoisted Vacuum - Slide-Ins
New! Units Available / Trade-ins Accepted! / Financing & Lease Plans



Oil Skimmer Sucking up money for vacuum trucks

Many times when oil is spilled, vacuum trucks are called for clean up. A vacuum truck using our skimmer will always get the job over a conventional rig because a vacuum truck using our skimmer is:

- 97% efficient
- Environmentally efficient
- Cost efficient
- Equipment efficient
- Simple and easy to use
- Recovers all types of oil
- Ideal for pits, lagoons and industrial oil recovery operations

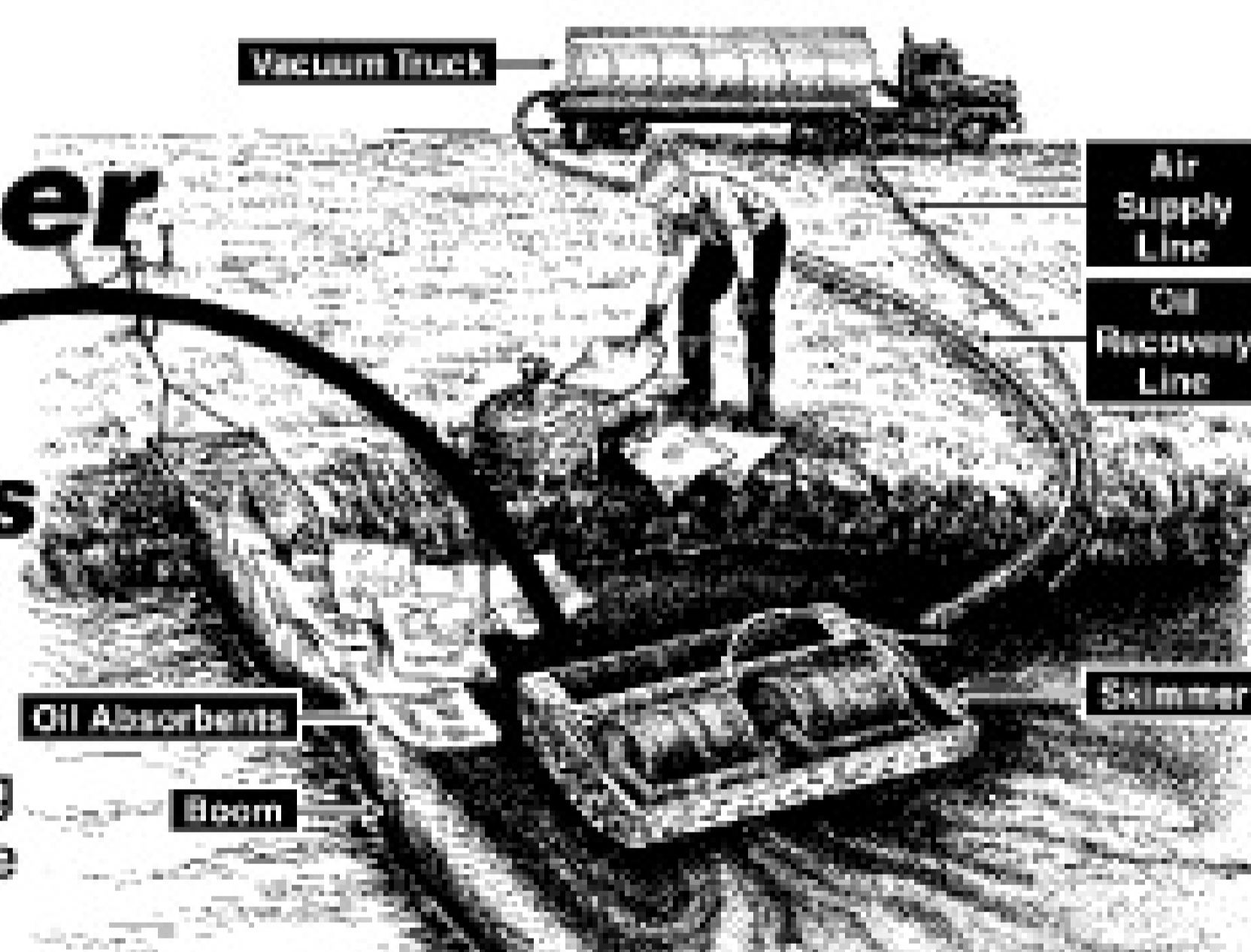

DrumIt The drum filling vacuum head with auto shut off



DrumIt quickly connects to vacuum truck. Ideal for chemical, oil or hazardous materials. Works on liquids, solids and sludges.

Trailer Mounted Vacuum Systems are Our Specialty



PACS is designed for easy dumping with fully opening rear door.

- Wide flotation tires and surge brakes for highway or off-road
- Various models available
- Standard units normally in stock
- Built with heavy-duty components
- Low maintenance with simple controls
- Designed for ease of towing
- Automatic mechanical shutoff
- Efficient and easy to use
- Extra strong frame withstands the difficult conditions of remote locations

Call for more info.
(618) 382-2525

www.elastec.com

ELASTEC
AmericanMarine
FOR INNOVATIVE ENVIRONMENTAL PRODUCTS

121 Council St., Carmi IL 62821 • Tel: 618-382-2525 • Fax: 618-382-3610 • Email: elastec@elastec.com

814.535.6766



www.gapvax.com

NEW TOWN...NEW VENUE...SAME ATTITUDE!

GapVax®

Setting the standard...as The World's Most Advanced Manufacturer of Industrial and Combination JetVac Equipment!

Thank you for attending the show...give us a call...let us know what we can build for you!



Sludge Mate
& Poly-Mate

The Flo Trend® Sludge Mate® and Poly-Mate® form an economical and simple to use sludge dewatering system. The Poly-Mate® conditions sludge through the addition of polymer prior to the dewatering process which occurs in the Sludge Mate®. These units are designed to dewater sludge from a multitude of waste stream sources including: water and wastewater treatment plants, septic tanks, car washes, industrial sumps and lagoons, grease traps, rendering plants, and food processing plants. The Sludge Mate® and Poly-Mate® are available in a variety of sizes and configurations, and are built to custom specifications.



DEWATERING MADE SIMPLE.

Flo Trend Systems Tel - 713-699-0152
707 Lehman St. 800-762-9893
Houston, TX 77018 Fax - 713-699-8054
sales@fлотrend.com

MEGA Holding Tank

1250 Gallon Size



Options

Black Color • Level Alarm • Custom Fittings

LOW PROFILE Portable Holding Tank

100 • 210 • 300
Gallon Sizes

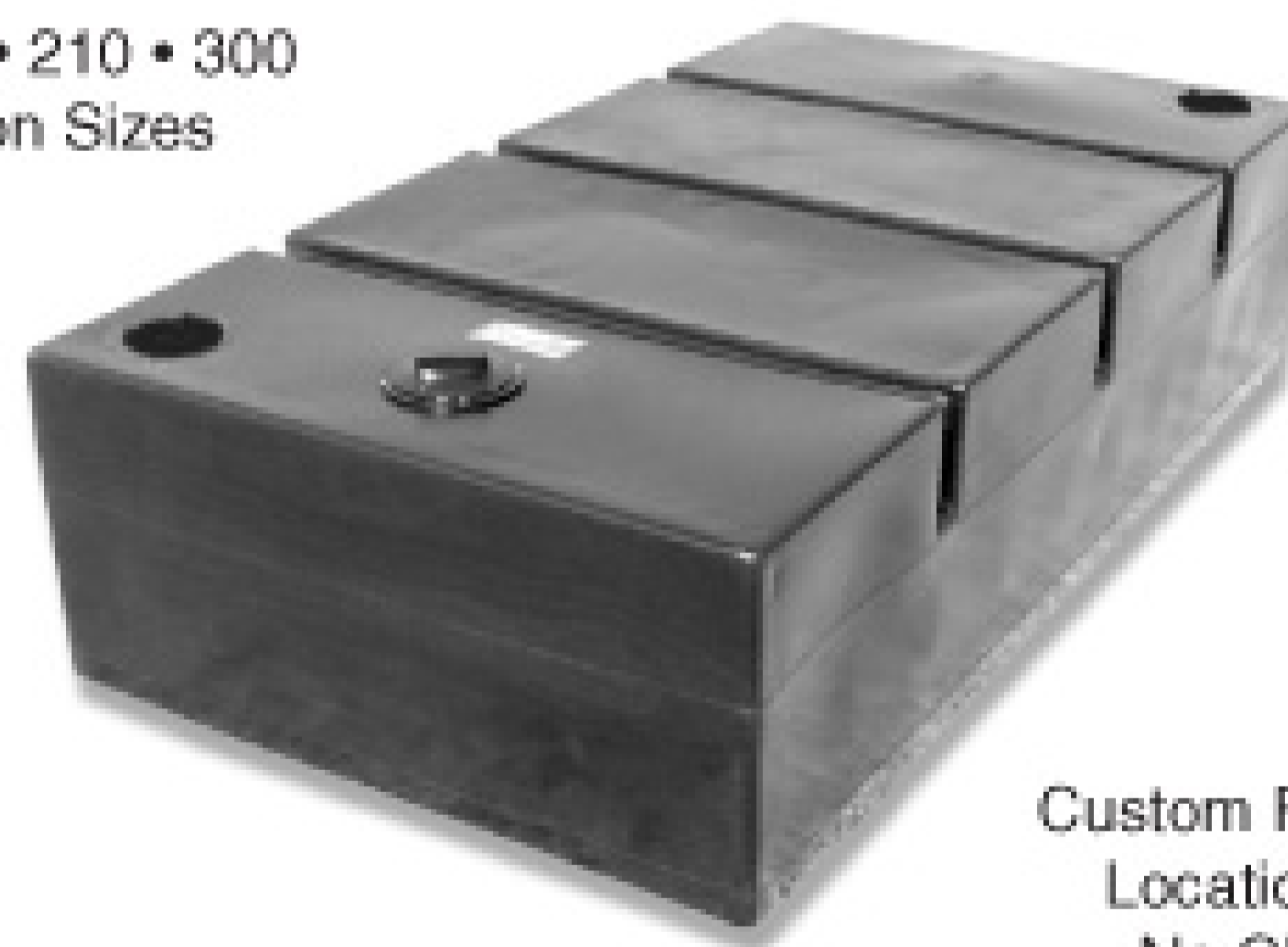

Custom Fitting
Locations at
No Charge

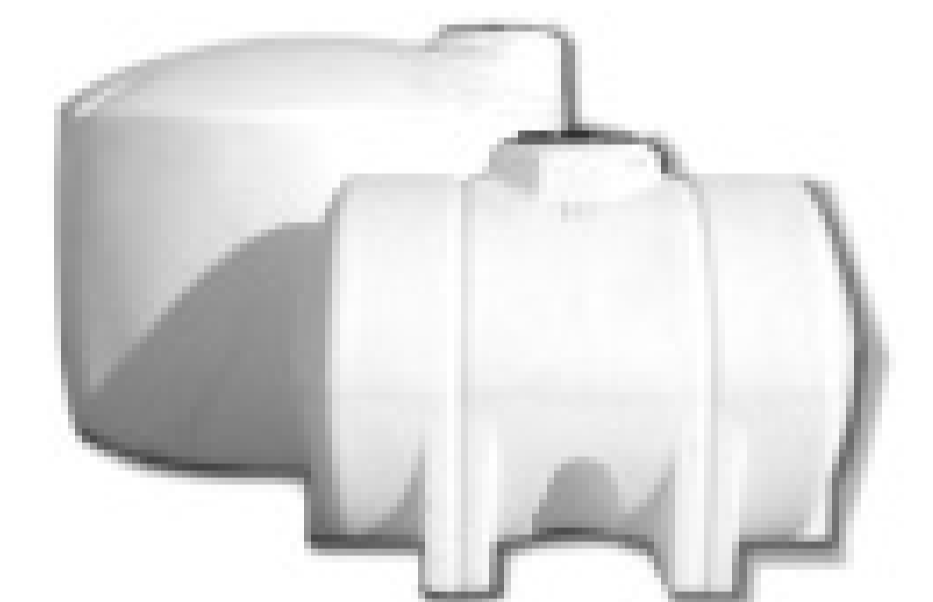

Bulk Storage and Transport Tanks



Septic and Cistern Tanks



Ball Valves and
Cam Lock Couplers

On-Site Water System

OSW PLUS —

- Tough 65 gal. Tank
- Removable cover for easy cleaning
- 115V On-Demand Pump 3.5 gpm 45 psi
- Low water shut-off
- GFCI Protected
- Filter
- Ships UPS

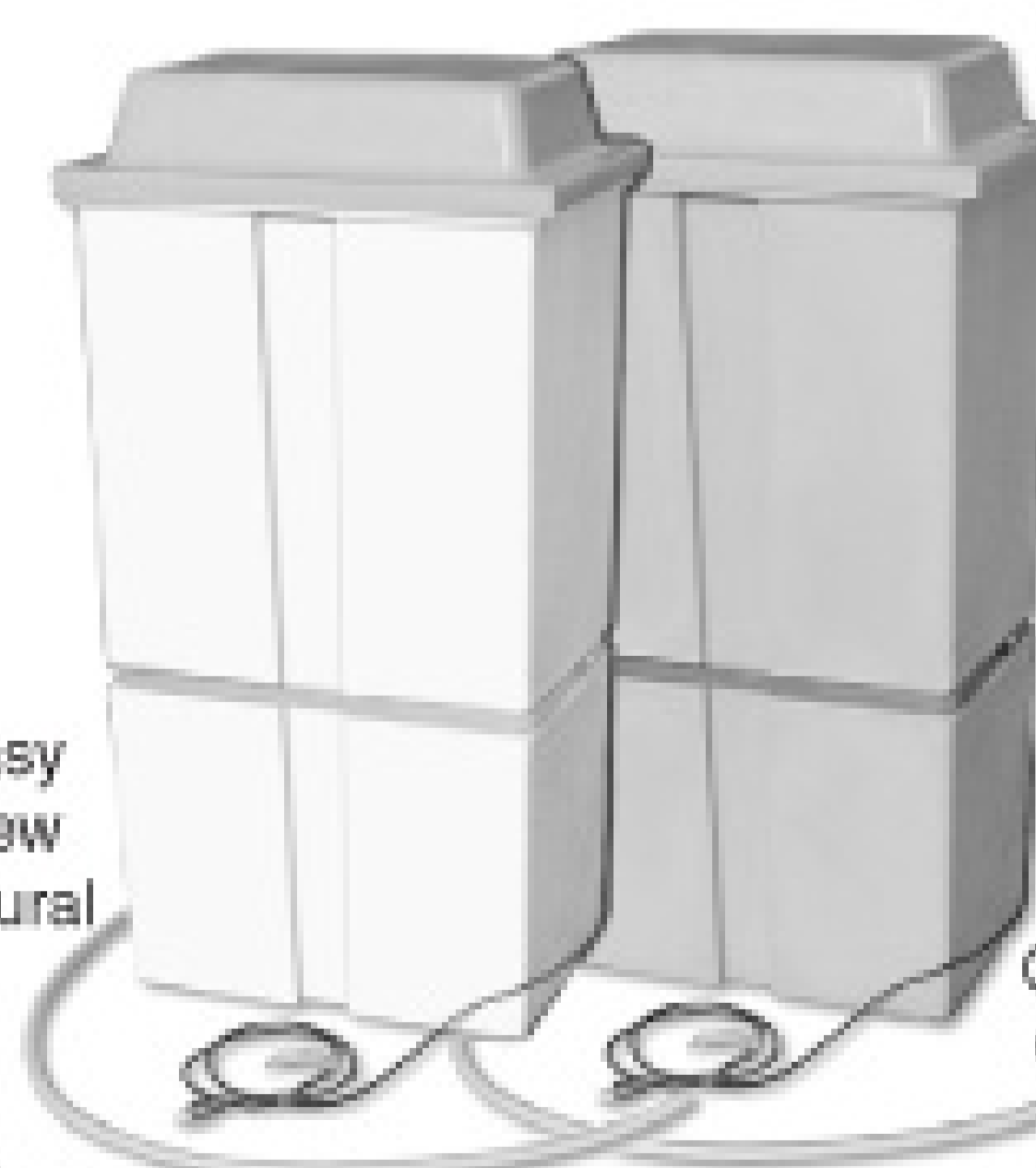

Easy View
Natural

Office
Grey

OSW DELUXE —

- Add external fill connection w/float valve

NORWESCO

Distributor Since 1987

Nationwide Shipping Points



KentuckyTank
Plastic Tanks and Accessories

1-888-459-8265

www.kentuckytank.com

27th TRUCKS INC.

WORLDWIDE EXPORTERS

8975 N.W. 27TH AVE. | MIAMI, FL 33147

PH: 305.835.9030 | EMAIL: INFO@27TH-TRUCKS.COM

Contact Alan @ 786-512-5597 or
Armando @ 786-267-3026

2 Year
Factory Warranty
on Pumps



2002 MACK

4500 Gallon Aluminum Tank, 10 Spd.,
350 HP, with Tri Axle, Jurop Pump
LC420 Contender (Extras Included) with
High Quality Custom Paint Job.



2000 PETERBILT

C12 Cat, New 4000 Gallon
Aluminum Tank, Fruitland Pump
RCF 500, 350 C.F.M., Custom Build.
Ready for Immediate Delivery!
Beautiful Truck!

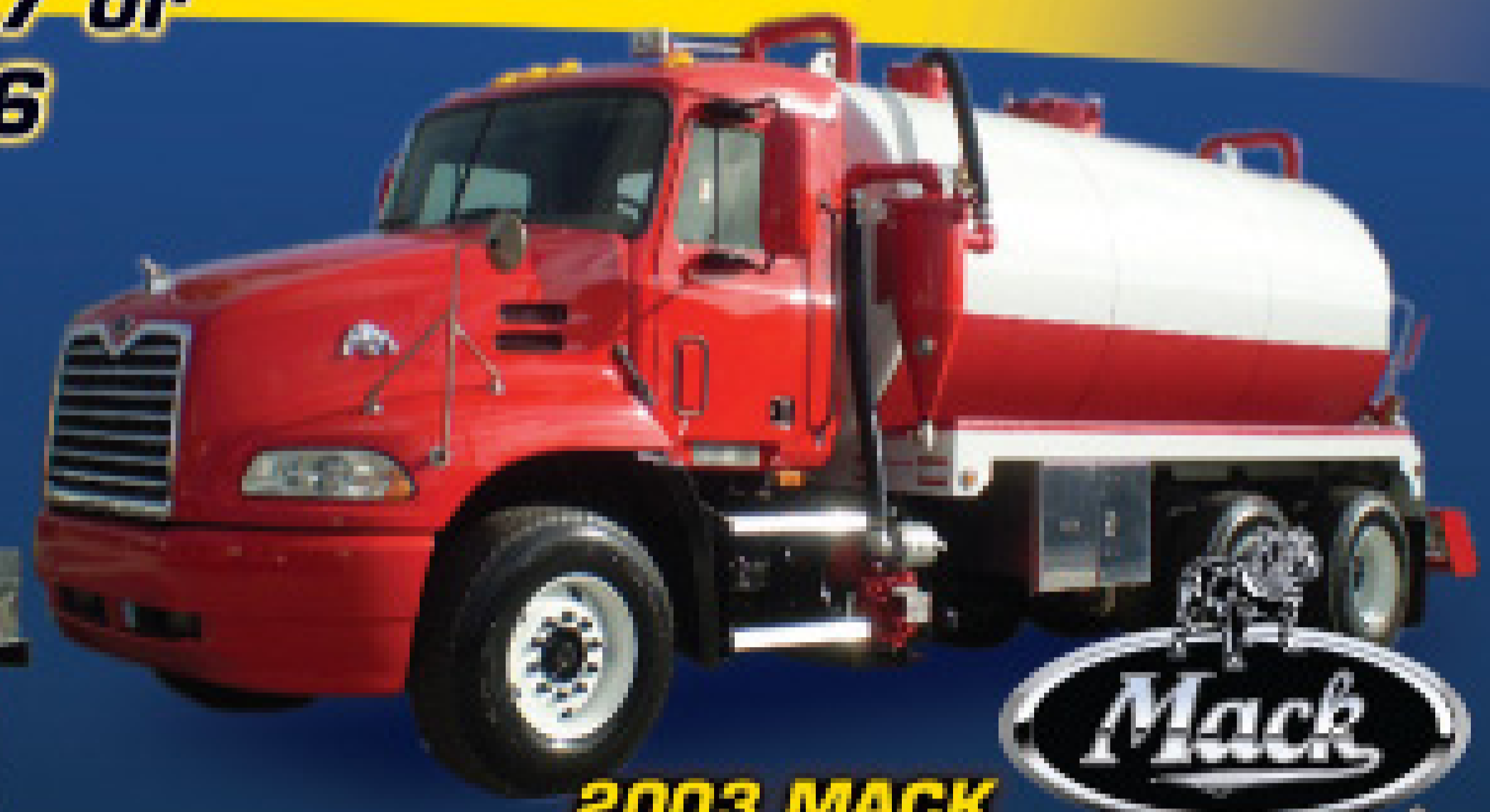

2003 MACK

10 Spd., Jake Brake, 570K,
4000 Gallon Carbon
Steel Tank, Jurop Pump LC420.



2001 STERLING AT9522

4000 Gallon Carbon Steel
Tank, Fruitland Pump RCF 500
350 C.F.M.



2003 PETERBILT 379 SHORTHOOD

10 Spd., N14 Cummins, 470 HP, 5000
Gallons with 200 Fresh Water Com-
partment, Jetter System, Tri Axle,
Fruitland Pump RCF 1200 650 C.F.M.
Best Truck of the Year.



2001 STERLING AT9522

4000 Gallon Carbon Steel
Tank, Fruitland Pump RCF 500
350 C.F.M.



SOLD

THANK YOU Eco Friendly



2000 PETERBILT C12

Cat 430 HP, 3600 Gallon
Progress Aluminum Tank
Fruitland Pump RCF 500,
350 C.F.M.



SOLD

5 year Factory Warranty
on Carbon Steel Tanks



Authorized
Fruitland Pump
Dealer



SOLD

THANK YOU Mr. John Hall



SOLD



SOLD

10 Year Factory Warranty
on Aluminum Tanks

WWW.27TH-TRUCKS.NET

FRUITLAND VACUUM PUMPS. SIMPLY THE BEST

We are the #1 vacuum vane pump servicing the oil fields across North America.

The reason is simplicity.

**We don't need gimmicks or water cooling to serve the harshest of applications.
Simple uncomplicated design that works.**

Features:

- Every Pump "Factory Tested"
- Low Maintenance Cost
- Continuous Duty
- Air - Cooled
- No Washboard
- Vacuum to 28 hg.
- Pressure to 30 psi.
- ISO Certified
- 2 Year Factory Warranty
- Automated Lubrication System
- User friendly Maintenance Features
- Models for Tanks sizes from 1000 to 12000 Gallons
- Drive option include; Hydraulic, Direct, Belt, and Right - Angle
- Proven in all environments (sub-zero to 100 degrees plus)



Markets:

- Industrial
- Oilfield
- Septic
- Grease
- Environmental
- Wastewater

**Used and Proven by
World's Top Liquid
Vacuum Service Companies.**

**Vacuum Pump Training
Courses available*

Fruitland Tool & Manufacturing

" Committed to Quality, Reliability, and Guaranteed Performance "

Contact us today: **1-800-663-9003**
Visit us @ www.fruitland-mfg.com For more info.

***We Squeeze the Crap
Out of Water™***

**Rotary Thickening
and Dewatering**
Simple systems that are
totally enclosed, compact
and easy to operate.

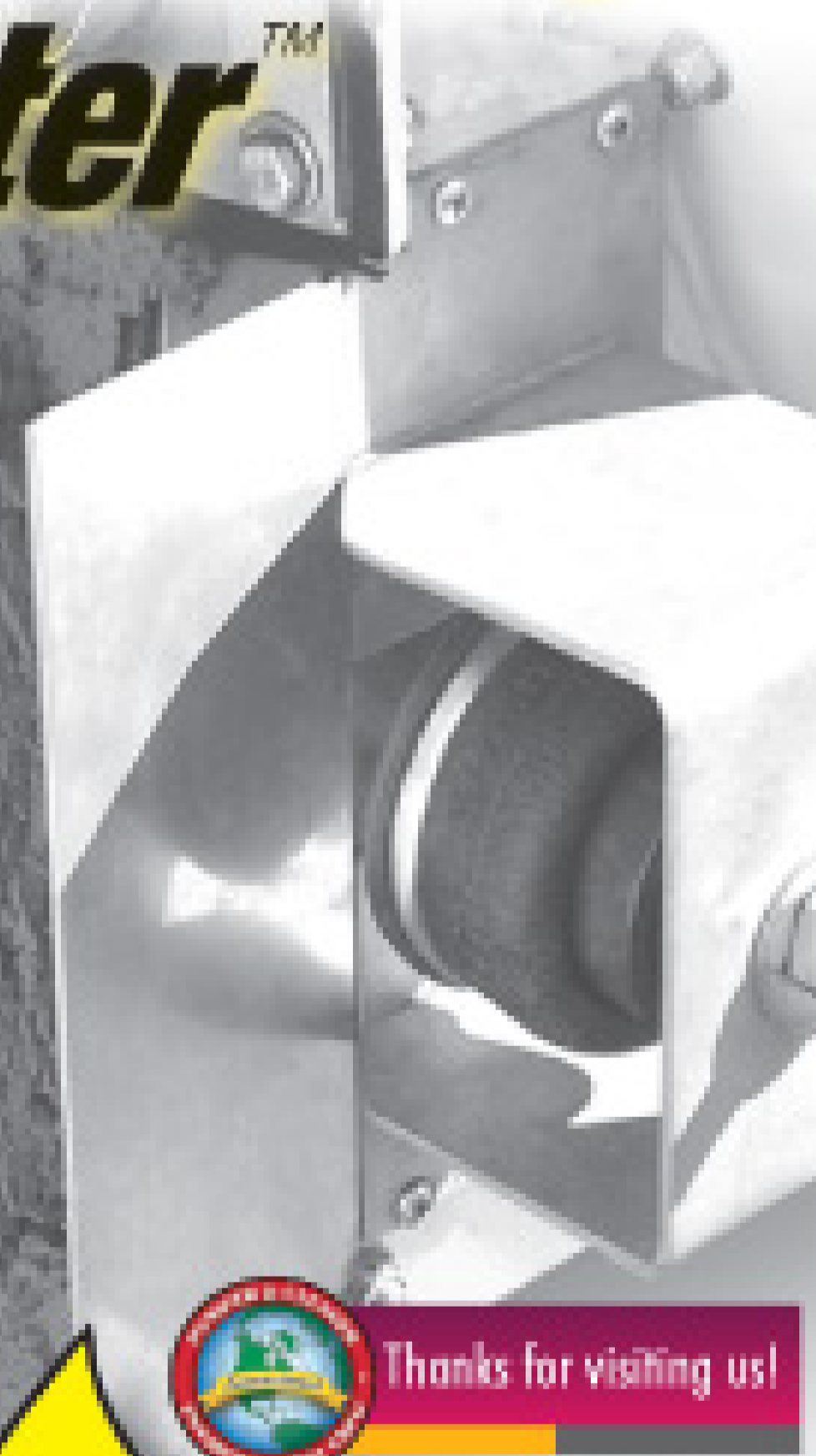

**PRIME
Solution
INC.**

PH: 269-673-9559
www.primesolution1st.com
Made In USA

Gasoline Hot Water Unit With Hose Reel

Aqua Blast has several models within the Gasoline Hot Water category, including Jetters. Our units range from 1600 to 10,000 psi at 3 to 10 gpm and have an adjustable hot water thermostat.

AQUA BLAST also offers the following styles of units with 900 psi to 30,000 psi and 2 gpm to 500 gpm.

Central cleaning systems with the installation of plug-in stations for hoses.

- Electric, gas, diesel or propane
- Truck, trailer or skid mounted, portable
- Hot, cold or steam



**AQUA BLAST™ Manufacturer of High
Pressure Cleaning Systems**

800-338-7373 • 260-728-4433 • Fax: 260-728-4517
E-mail: davidt@aquablast.com • www.aquablast.com

BEST ENTERPRISES, INC.

300/110 Slide In



400/200 Slide In



A special thanks to everyone that came by to see us at the Pumper show. It was wonderful seeing all of our old friends and making new ones. I hope everyone enjoyed the show and had a safe trip home. Much success in the year ahead and Happy Pumping! Gayle Humphries

Price Reduced
While Supplies Last

400/150 Slide In



150/400/150 Slide In



2,500 gallon all waste - Mirror Finish Stainless Steel Tank on an 2008 International Truck.



2008 Kenworth T300 with a 1500 gallon Stainless Steel Tank and customized accessories.



We would like to thank Tim Slattery of Paintbrush Services in Gillette Wyoming for purchasing our Kenworth Show Truck.

3,200 gallon - All Waste Stainless Steel ROLL OFF TANK



Best Enterprises, Inc.
3513 W. Mt. Springs Rd.
Cabot, AR 72023

1-800-288-2378
www.bestenterprises.net

No Compromise



Don't accept a substitute for quality. The Burks DC-10 is still the most popular, high volume washdown pump available.

With flow rates to 20 gpm and pressure to 40 psig, the Burks DC-10 is the pump of choice for filling and washing your portables.

Contact your local tank manufacturer for more info, or call us toll-free at:

800-699-7557

**ARMSTRONG
EQUIPMENT
INC.**

11200 Greenstone Ave. • Santa Fe Springs, CA 90670

562-944-0404 • Fax: 562-944-3636

www.vacpump.com



CIRCLE D TRUCK SALES

www.circledtruck.com



NEW TANK

(2) 1998 MACK RB688S, E-7 Mack 350 HP, 9 Speed, Engine Brake, Camelback Suspension, 4.64 Ratio, 190' WB, 24.5 Tires, Aluminum / Steel Wheels, Tandem Axle, 12,000# FA, 38,000# RA, HD frame, AM/FM Stereo, P/S, A/C, New Chrome Bumper, (2) 80 Gallon Aluminum Fuel Tanks, Detailed And Serviced. New White Paint. **"NEW"** 2007 Bulldog Vacuum Tanks, 3,360 Gallons (80bbl), 1/4" Head & Shell Thickness, Primary & Secondary Shutoff, (2) Top Man Ways, (1) Rear Clean Out, (2) Internal Baffles, Sump With (2) 4" Rear Outlets With Wafer Style Butterfly Valves, Front Sight Glass, Vacuum & Pressure Relief Valves, Full Length Hose Trays, Rear Bumper, Jurop R260 Vacuum / Pressure Pump With Pump Stand And Right Angle Drive. Stk. #1487 **\$74,500 each**



VERY NICE!

2001 MACK CX613 VISION, E7-427 Mack, 10 Speed Autoshift, Engine Brake, Air Ride Suspension, 3.70 Ratio, 220' WB, 22.5LP Tires, All Steel Wheels, Tandem Axle, 500-600K Miles, Tilt, Cruise, AM/FM Stereo, Fleet Maintained, (2) 145 gal Aluminum Fuel Tanks, **"NEW"** 2007 Bulldog Full Tilt Vacuum Tank Hydraulic driven, Controls on driver side, 3,360 Gallons (80bbl), 1/4" Head & Shell Thickness, Primary & Secondary Shutoff, (2) Top Man Ways, (1) Rear oversized Clean Out air operated, (2) Internal Baffles, Sump With (2) 4" Rear Outlets With Wafer Style Butterfly Valves, Front Sight Glass, Vacuum & Pressure Relief Valves, Full Length Hose Trays, Rear Bumper, Jurop R260 Vacuum / Pressure Pump Hydraulic driven fan cooled. Stk #1790 **\$89,500**

Available Soon: 1992 Volvo w/Vactor unit, good spec's, being refurbished - Call for price!

MORE TRUCKS AND TRAILERS AVAILABLE, IF WE DON'T HAVE IT WE'LL FIND IT!

**Lee Dill, Richard Roberts, John Trammell, Gary Chandler
CIRCLE D. TRUCK SALES**

**4502 E. OVERLAND TRAIL • ABILENE, TX • 79601
325-677-0474 • FAX: 325-673-7207**

888-433-0474



VERY NICE!

2007 International 5900i, CAT 430HP, Allison 4500-RDS 6 speed w/double overdrive, 46,000lb RA, 20,000lb FA, Hendrickson Air-ride suspension, 4:56 ratio, locking differential, 11R24.5 rear tires, 425/65 22.5 Front flotation tires, All Aluminum wheels, (2) Aluminum 100gl. fuel tanks, Chrome exhaust, AC, PS, AM/FM stereo, Electric windows, locks, Tilt, Cruise, White paint. **New 2007 Bulldog Vacuum Tanks**, 3,360 Gallons (80bbl), 1/4" Head & Shell Thickness, Primary & Secondary Shutoff, (2) Top Man Ways, (1) Rear Clean Out, (2) Internal Baffles, Sump With (2) 4" Rear Outlets With Wafer Style Butterfly Valves, Front Sight Glass, Vacuum & Pressure Relief Valves, Full Length Hose Trays, Rear Bumper, Fruitland RCF500 Vacuum/Pressure pump. Stk.#2947 **Call For Price**



4 IN STOCK

2005 MACK VISION CX613 "NEW" Presvac DOT-MC MC 412, 3150 Gallon, Tilt With Full Open Rear Head, 4" Load Line With Riser, 6" Discharge, Catwalk With Handrails, Fruitland RCF 500 Vacuum Pump, Tilt, Cruise, AM/FM, Fleet Maintained, (2) Alum Fuel Tanks **\$135,000**



12 IN STOCK NOW

(12) 2007 Troxell Vacuum Trailer, non-code, 130bbl. (5,460 Gallons), 4 Spring Suspension, Steel Composition, 24.5 Tires, All Steel Wheels, Tandem Axle, 1 Compartments, Full length walkway with Tool box, (2) 4" butterfly valves, scrubbers, Full length hose trays. Ready to haul!!! FET included in price, **\$43,504. Price includes FET.**

Our Green is REALLY GREEN!



FIVE PEAKS TECHNOLOGY

231.830.8099 | www.fivepeaks.net

866.293.1502



GREEN RIBBON PROGRAM

Our commitment never ends! Five Peaks Technology continues to “Lead the Evolution in Portable Sanitation” through exemplary dedication and commitment to a safe and healthy environment. Our strategies include recycling our plastic, recycling our packaging materials, refined purchasing habits towards recycled products, extensive energy audits throughout our plants, and the purchase of hybrid company vehicles.

As a Green Ribbon Partner, Five Peaks is committed to our industry, to environmentally sound waste management and to energy saving practices. If you join us as we continue the path towards a GREEN ENVIRONMENT, others are sure to follow!

To learn more about the Green Ribbon Program, visit greenribbon.net

COVER STORY

MAN OF STEEL

Metalworking Minnesota contractor shares his truck-building and maintenance tips

By Jim Kneisz

Greg Posch is as comfortable with a welding torch as he is with a vacuum hose. Here he reinforces the receiver hitch on an Isuzu vacuum truck. (Photos courtesy of Tri-County Septic)

Running a pumping, portable sanitation and septic system installation business in the heart of Minnesota, Greg Posch has a lot of downtime between Christmas and the spring thaw. On most days during the frigid winter, Posch trades the pumping wand for a welding torch.

The seasonal workload at Posch's family business, Tri-County Septic LLC in Holdingford, Minn., has been well established since he put his first vacuum truck on the road 21 years ago.

In the summer, Posch, 52, and his son, Keith, pump about 1,000 tanks, usually residential and often involving onsite systems and holding tanks at vacation lake properties. They keep a small inventory of



Posch checks the oil in his refurbished septic vacuum truck in the Tri-County Septic workshop.

portable restrooms, usually in use on construction sites and the occasional special event when the weather is nice. And last year they started squeezing in a few onsite system installations each year, as Keith became a licensed installer.

But in the winter, when service calls slack off beginning in December, Greg Posch trades one passion — pumping and providing customer service — for another — building vacuum trucks.

Greg and Jenny Posch work out of their home office. Jenny handles the books for the family business that's based in central Minnesota.

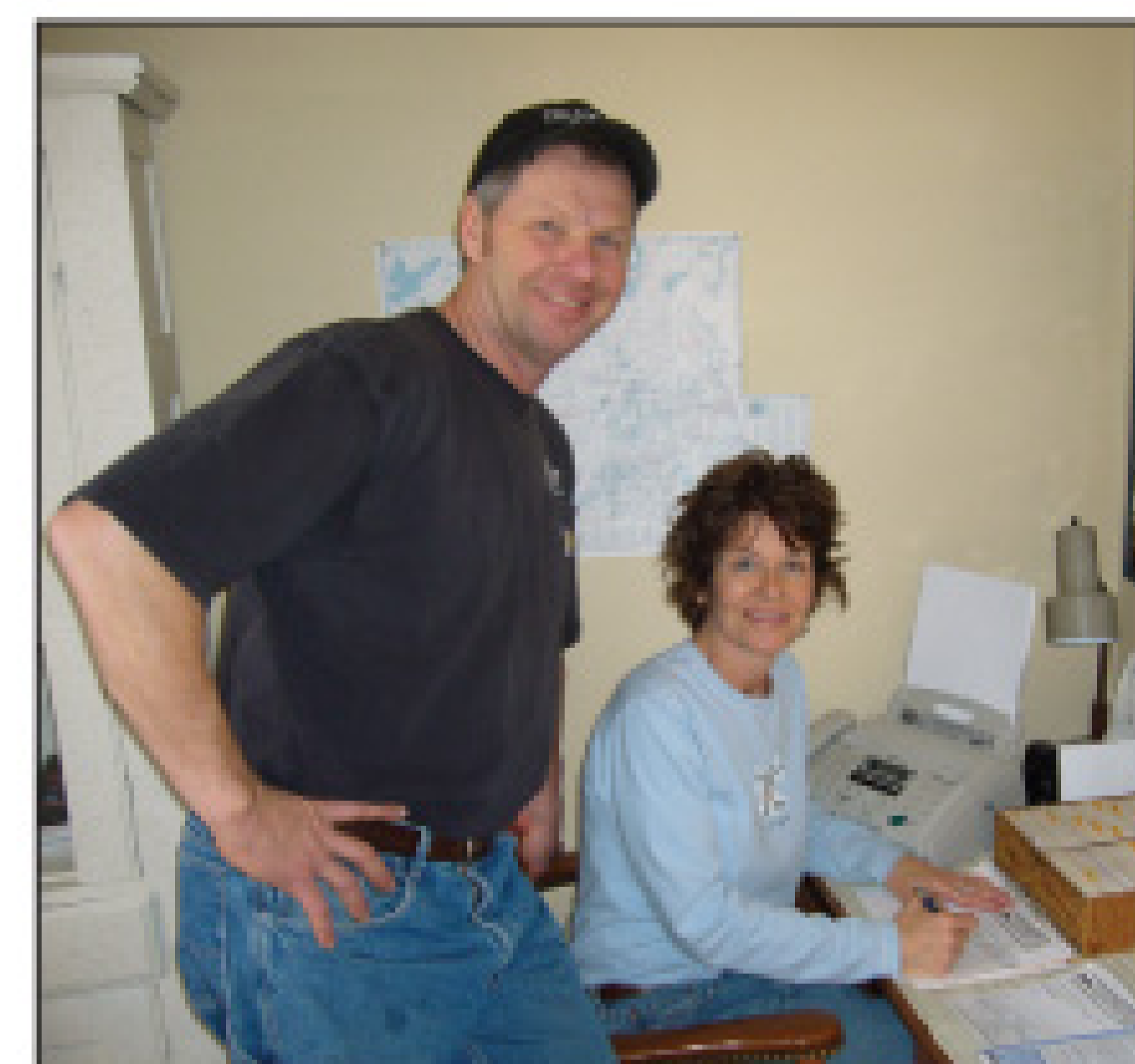

Profile

Tri-County Septic LLC
Holdingford, Minn.



Owner:	Greg Posch
Founded:	1987
Employees:	2.5
Service area:	30-mile radius of Holdingford
Specialties:	Residential and commercial pumping, portable sanitation and onsite system installation

Before



Above, the 1988 Ford L8000 when it still carried its municipal vac truck colors before Posch transformed it into a pump truck. At right, Greg and Keith Posch next to the refurbished rig.

“IT’S PRETTY EASY TO PUT A TRUCK TOGETHER WHEN YOU CAN PAINT AND WELD AND CUT AND HAVE A SHOP TO PUT IT ALL TOGETHER. BUILDING FROM SCRATCH TAKES A LOT OF TIME, BUT I KIND OF ENJOY DOING IT AND I KNOW WHEN I GET DONE THAT I’LL HAVE WHAT I WANT.”

Greg Posch

After



BUILDING FROM SCRATCH

Posch has the perfect background for building his own service vehicles. He learned welding in high school, then ran his own body shop for a decade before grabbing his first vacuum hose. He’s built all seven of his main vacuum trucks, the latest being a three-year project to transform a lightly-used L8000 Ford municipal vac truck with a hoist dump into a no-nonsense liquid waste hauler that serves his business well, cleaning tanks within a 30-mile radius around his hometown near St. Cloud, Minn.

“It’s pretty easy to put a truck together when you can paint and weld and cut and have a shop to put it all together,” says Posch. “Building from scratch takes a lot of time, but I enjoy doing it and I know when I get done that I’ll have what I want.”

In addition to building his trucks, Posch does as much maintenance as he can. That includes oil changes and engine and brake work. It’s all performed in his 40- by 80-foot shop located on his family farm of 80

acres. The shop is split into two 40- by 40-foot sides, one unheated for storage and one heated and outfitted for serious mechanical work. The shop is stocked with welders, grinders, torches and a hoist to handle tanks and engines. A friend with a bender and shearer helps Posch out with stainless steel, which the pumper prefers to utilize wherever possible to make trucks that last a long time and don’t need repainting due to rust.

The Posch family runs the business out of a home office at their farm, where they also land-apply septage and grow cash crops. About 10 years ago, Posch dipped his toe into portable sanitation, adding 20 Satellite Industries Inc. Tufway restrooms that are in constant use in the summer. They run a 1995 Isuzu pumper with an 800-gallon (600 waste/200 freshwater) tank for the portables.



Keith Posch is shown on a winter residential septic pumping run. Above, he pulls the cap and attaches the vac hose. At right, he battles cold temps to pump the tank. At top right, Keith discusses the pumping job with the customer. Heavy snow cover usually does a good job of insulating onsite systems from a frigid winter climate.



Greg and Keith Posch wash the refurbished truck regularly to maintain the glossy safety purple paint job.



Father and son pump 2-3 septic tanks daily in the summer, a number that rises to 6-8 in the fall as cottage owners call for holding tank cleanings. Jenny Posch, Greg's wife, does the bookkeeping and billing.

IDEAS FROM EXPO

Posch bought the Ford for \$12,000, removed and sold the vac unit, shortened the wheelbase, cut the frame and slid the axles forward to fit the 3,300-gallon tank. A nearby subcontractor cut the drive shaft to fit the new truck and Posch assembled the PTO. He added heated valves to keep the truck functional in cold weather, as winter sometimes brings emergency calls. He painted the tank safety purple for good visibility.

Tri-County usually keeps its vacuum trucks about a decade, selling them in good working order with less than

250,000 miles on the units. Keeping them garaged and clean, they remain on the



Keeping up on routine maintenance helps Greg Posch keep his trucks on the road for years.

TALKIN' TRUCKS

10 tips from pumper Greg Posch for shopping for and maintaining your next service vehicle

1 Keep moisture trap down low

A long time ago, Posch noticed truck builders who located the secondary moisture trap and associated piping down low, where they weren't a focal point when you looked at the truck. In his own trucks, he started running the pipe through the center of the tank to place the trap below the skirting for a cleaner look and to keep the trap from catching tree branches in tight service areas.

2 Add full skirt bumper

If you want the cleanest look at the rear of the truck, Posch recommends adding a full back plate skirt that flares around the side. In his trucks, a beefier rear skirt hides the hoses running to heated valves and protects the truck from winter slop kicked up by the rear tires.

3 Make it stainless

If you can afford a stainless-steel skirt, toolbox or hose tray, buy it. Although the cost of stainless-steel components is higher, they provide more carefree service over the life of the truck, Posch contends. "I know it's kind of spendy, but you'll come out ahead," he says. "On my last truck, I repainted the painted bumper three to five times in 10 years and it never looked that good. A stainless bumper will always look good."

Stainless skirts, mud flaps and other parts won't corrode, so they'll look as good when you sell the truck as when you added them. Because it won't corrode, Posch says you can use a lighter grade of stainless over mild steel components. And because stainless bolts won't rust, it'll always be easier to remove them if you need to. "There's nothing worse than rust going down the side of your tank from a rusty bolt," he adds.

4 A fine finish

After running a body shop for many years, Posch has developed a procedure for painting he says produces a good-looking finish that lasts a long time. First off, he sandblasts a steel tank just before painting to knock off any oxidation and create a surface that paint adheres well to. Then he adds two coats of epoxy sealer and three coats of the best polyurethane paint he can buy. He warns that low-grade paint is more likely to dull and chalk over time. His process yields a finish that remains shiny and resists scratching and chipping for 10 years or more.

5 Lower the tank

When he sizes up new trucks at the Pumper & Cleaner Expo, Posch wants to see the vacuum tank placed as low to the frame as possible. A lower tank drops the center of gravity,

distributing the weight better for effective cornering and overall handling capabilities. The lower tank also saves a rig from scratches due to low-lying tree branches.

6 Load 'er up with options

If you're going to order a new truck, spend a little more up front to get driver comfort options like air conditioning, air-ride seats, cruise control and satellite radio or a good stereo. Keep in mind that the nice features end up being a relatively small part of the total price of your next truck. "It'll cost you a little more, but the value will be there when you sell it, too," he says.

7 Go automatic

For most of his life as a pumper, Posch refused to consider a truck with automatic transmission. His latest rig was such a good deal, he bought it despite what he thought was an inferior automatic. Now that he's used to the convenience, he'd never return to a stick shift. "I know they say you can lose the MPG's, but it's just so much nicer to drive," he says. "Backing into yards, you can ease in there nice and slow and take your time." He says the Allison 6-speed auto is smooth and trouble-free.

8 Be militant about routine maintenance

Posch prides himself on keeping a

truck at least 10 years, then still getting a good price when he sells it. Staying on top of maintenance is a big part of that successful pattern. While he doesn't do anything out of the ordinary, he makes sure engine oil is changed every 5,000 miles, the truck is kept greased, stored inside and gets washed regularly.

9 Flush the pump

The Jurop 260 pump on Posch's last service truck was reliable for 10 years and never had to be taken apart. He flushed the unit twice a year with diesel fuel and ran quality non-detergent oil in the pump. Beyond flushing, the key to pump longevity, Posch says, is not running it at high rpms and causing overheating.

10 Buy a welder

While Posch considers many tools to be essential in his shop, he says a good, simple wire-feed welder should be a must-have for any pumper who plans to do any of his own equipment repairs. While he also regularly uses a heliarc TIG (Tungsten Inert Gas) welder, a wire-feed MIG (Metal Inert Gas) welder is inexpensive (roughly \$1,500) and is easy to use. He said the welder could be used to make simple equipment repairs, saving pumpers from subcontracting a lot of work. "I could never get by without one. We use it all the time," he says.



Forks are added to a Bobcat T-180 to load a Satellite Industries Tufway restroom to the back of Tri-County's portable sanitation truck, a 1995 Isuzu with an 800-gallon stainless-steel tank.

road indefinitely. Posch's first rig, a 1974 GMC with a 1,750-gallon tank, is still being used by another contractor.

The recent Ford project also figured into Posch's favorite annual road trip, visiting the Pumper & Cleaner Expo. On his way to the 2007 Expo, Posch stopped at LMT Inc. in Galva, Ill., to have a plain steel barrel welded to two heads he recycled from another tank back home. On the way home from the Expo, he picked up the tank, then prepped it for painting and bolting to the Ford's frame.

"ON MY LAST TRUCK, I REPAINTED THE PAINTED BUMPER THREE TO FIVE TIMES IN 10 YEARS AND IT NEVER LOOKED THAT GOOD. A STAINLESS BUMPER WILL ALWAYS LOOK GOOD."

Greg Posch

Posch says he scours the Expo exhibits every year, looking for tricks and ideas he can implement on his own trucks. He picks the brains of the pros who display trucks and shops for pumps, accessories and other components he'll use on his next rig. The Expo and his own imagination account for many of the convenience features he's adapted to his trucks over the years.

"I get so many ideas when I go down to the show. I picked out the best ideas and put them all on this truck," Posch says. "And I've been building and upgrading trucks for so long, I know where all the wear points are and where I can use stainless steel." ■

MORE INFO:

LMT Inc.
309/932-3311
www.tanksandpumps.com

Satellite Industries Inc.
800/883-1123
www.satelliteindustries.com

We pay attention to the details.

- Fabricated to the best industry standards using the highest quality products available
- Custom configurations to your specifications
- VISA, American Express, MasterCard, & Discover
- Fast, same day shipping, low freight rates



ATLANTA RUBBER & HYDRAULICS

1640 D Sands Place
Marietta, GA 30067
Toll Free: 800.282.6272
Phone: 770.955.5225
Fax: 770.955.2377
e-mail: dragsdale@atlantarubber.com

TankTec

Tank Technologies & Supply Co. LLC

Portable Restroom Service Trucks
Septic, Grease & Grit Trucks
Refined Fuel Trucks

2008 Ford F750
2500 Gallon

From **\$83,900**

6-Speed • 33,000 lb G.V.W. • 260 HP
Moro PM80 360 CFM Pump System
Lease from \$1600/Month



LIFT TANKS:

Single Axle from **\$97,000**

Tandem Axle from **\$114,000**



IN-STOCK CHASSIS FROM:

Mack • Sterling
Ford • Chevy • Peterbilt
Kenworth • International • & More!

MANY PUMP OPTIONS AVAILABLE

INCLUDING PUMPS FROM:

Masport, MORO, NVE, Whittig
and the new
Robuschi blower pumps!

ROBUSCHI®



TankTec • WE'RE YOUR EQUIPMENT EXPERTS!



888.428.6422

ALL NEW!



- DIESEL V-8
BUILT FOR:**
- Performance
 - Economy
 - Reliability
 - Power
 - Durability
 - Low Noise
 - Low Emissions

MAXXFORCE 7
INTERNATIONAL DIESEL POWER™



2008 International 4300 M7
2000 Gallon

From **\$77,700**

ALL NEW! MAXXFORCE 7 DIESEL V-8

Lease from \$1300/Month



TankTec • WE'RE YOUR CHASSIS EXPERTS!

Standard PRS Features:
Masport HXL4V 160 CFM
Vacuum Pump System
Burks DC-10 Water Pump
Fold Down 2 Toilet Hauler
2 Large Work Cabinets

2008 Isuzu NRR
1500 Gallon

From **\$70,700**

Lease from \$1400/Month



Ask About In Stock Trucks • Call for Lease Payment Details
Tanks in Stock • Financing and Leasing Options Available • Dual-Use Options
Customize to Your Needs • PRS 800-2500 Gallon • Vacuum 1000-6000 Gallon

PORTAVAC



ALUMATEANK

Tank Technologies & Supply Co. LLC • 888.428.6422 • www.tanktec.biz

Steve Nelson • snelson@tanktec.biz
Andy Nelson • anelson@tanktec.biz

Local • 763.755.8075 • Fax • 763.757.9788
10100 Quinn St. NW, Minneapolis, MN 55433

KMH EQUIPMENT COMPANY

SALES • RENTALS • SERVICE

KMH Equipment has many well maintained quality trucks and equipment for sale or for daily, weekly, or monthly rental. Financing Available

- Vacuum Trucks
- Combination Trucks
- Hydro Excavators
- Jetters
- DOT Certified Trucks
- Sweepers

PRESVAC



VACALL™

Phone 1.888.KMH.0202

www.kmhequip.com

Michigan Vacuum Trucks

Custom Built Tanks to Your Specs!

P.O. Box 234 Carleton, MI 48117



Custom Built Vacuum Trucks to Meet Your Business Needs

All trucks are equipped with Masport Pumps
1/4" Steel Construction

Totaled Your Truck?

Rent a Vacuum Unit while your truck gets fixed

THANK YOU

U.S. Ecology Idaho for purchasing a 4000 gallon vacuum unit from Michigan Vacuum Trucks.

Masport®
NVE

Specializing in
New Vacuum Trucks,
Used Vacuum Trucks,
Toilet Trailers & Slide in Units.

Purchase a New Portable Toilet Truck for only \$45,000*

In Progress: **2007 Freightliner M-2**
250 HP Cat, 6-speed manual, 18,000 miles full factory warranty, NEW 2500 gallon vacuum body Masport HXL400WV vacuum pump, 2 manways, 3 sight eyes, 4" discharge, 3" inlet, painted to suit. **\$67,000**
Call Terry at Michigan Vacuum Trucks 734-777-0390

We Can Also Mount a Custom Designed Vacuum Tank on Your Chassis!

Call for a **FREE** quote today!

734.777.0390

*Prices are subject to change.



TUF-TITE®



Thanks for visiting us!

For Samples & Pricing
Call: 800-382-7009

Septic Tank Riser, Lid & Safety Pan™

FREE FREIGHT ON FULL CARTONS!



Tank Adapter Ring

New - Horizontal Safety Screw.

Safety Pan™ to Riser attachment with 6 vertical stainless steel screws.

Riser to Riser attachment with 6 vertical stainless steel screws.

Patent Numbers
5,617,679 &
5,852,901; other
pats. pending.

Riser Lid

with Molded-in gasket.
Available in 12", 16", 20" and 24" diameters.

Concrete Lid w/handle

Safety Pan™

Safety Pan™ available in 16", 20" and 24" diameters.

Riser

For septic tanks. Stackable in 6" increments. Available in 12", 16", 20" and 24" diameters.

Tank Adapter Ring

For mounting riser flush to top of tank when casting-in is not an option.

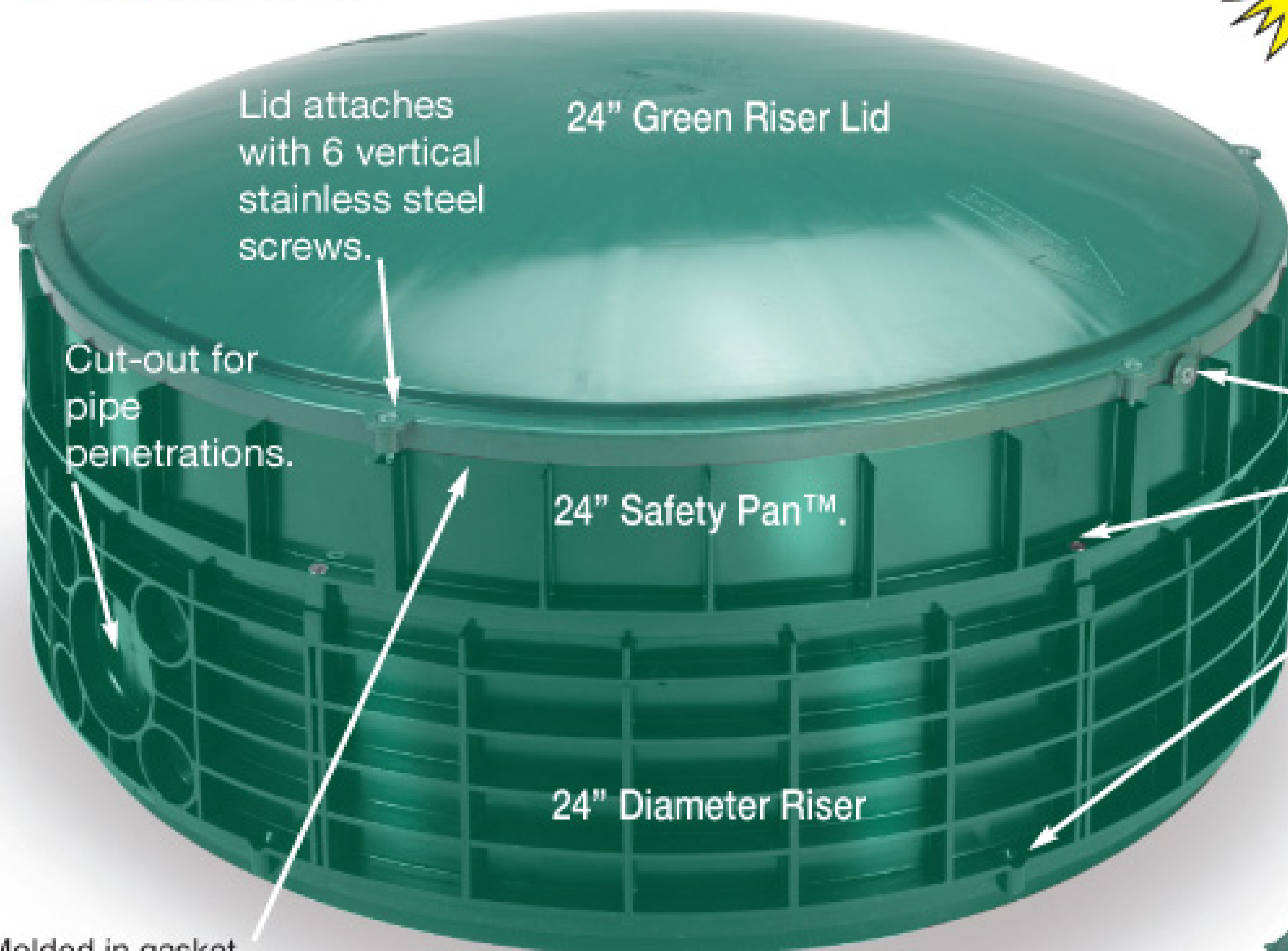

Lid attaches with 6 vertical stainless steel screws.

24" Green Riser Lid

Cut-out for pipe penetrations.

24" Safety Pan™.

24" Diameter Riser

Molded in gasket.

Available in 12", 16", 20" and 24" diameters.

Effluent Filters

Patent Numbers
6,319,403; D 431,629; other
pats. pending.

800 GPD
ANSI/NSF
Standard 46

4" Sch. 40 & SDR-35

EF-4
4" Filter

EF-6
6" Filter

1500 GPD
ANSI/NSF
Standard 46

4" Sch. 40 & SDR-35

244 ft. of
1/16" filtration
area.

Gas/Solids
Deflector

One-Piece Tank Seal

For concrete Septic tanks and D-boxes.
Accepts pipes from 1-1/2" to 4".
Mounts with or without concrete flash.



TS-4-RUBBER TANK SEAL
(will hold 10psi)
TS-4PRO TANK SEAL
(will hold 5" vacuum)

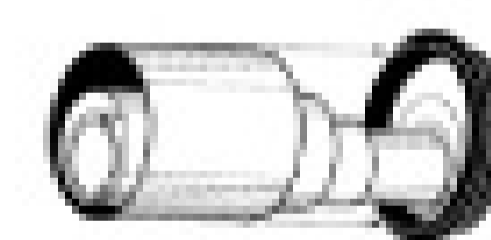

Free Freight: 32c

Patent No's
4,951,914,
5,624,123
& 5,711,536;



12", 17", or 20"

Tested to 10" vacuum

Tuf-Tite®, Inc. • 500 Capital Drive • Lake Zurich, IL 60047
800-382-7009 • 847-550-1011 • (fax) 847-550-8004 • www.tuf-tite.com
Plastic... Our Business, Not Our Hobby™





PORTA-JOHN UNITS

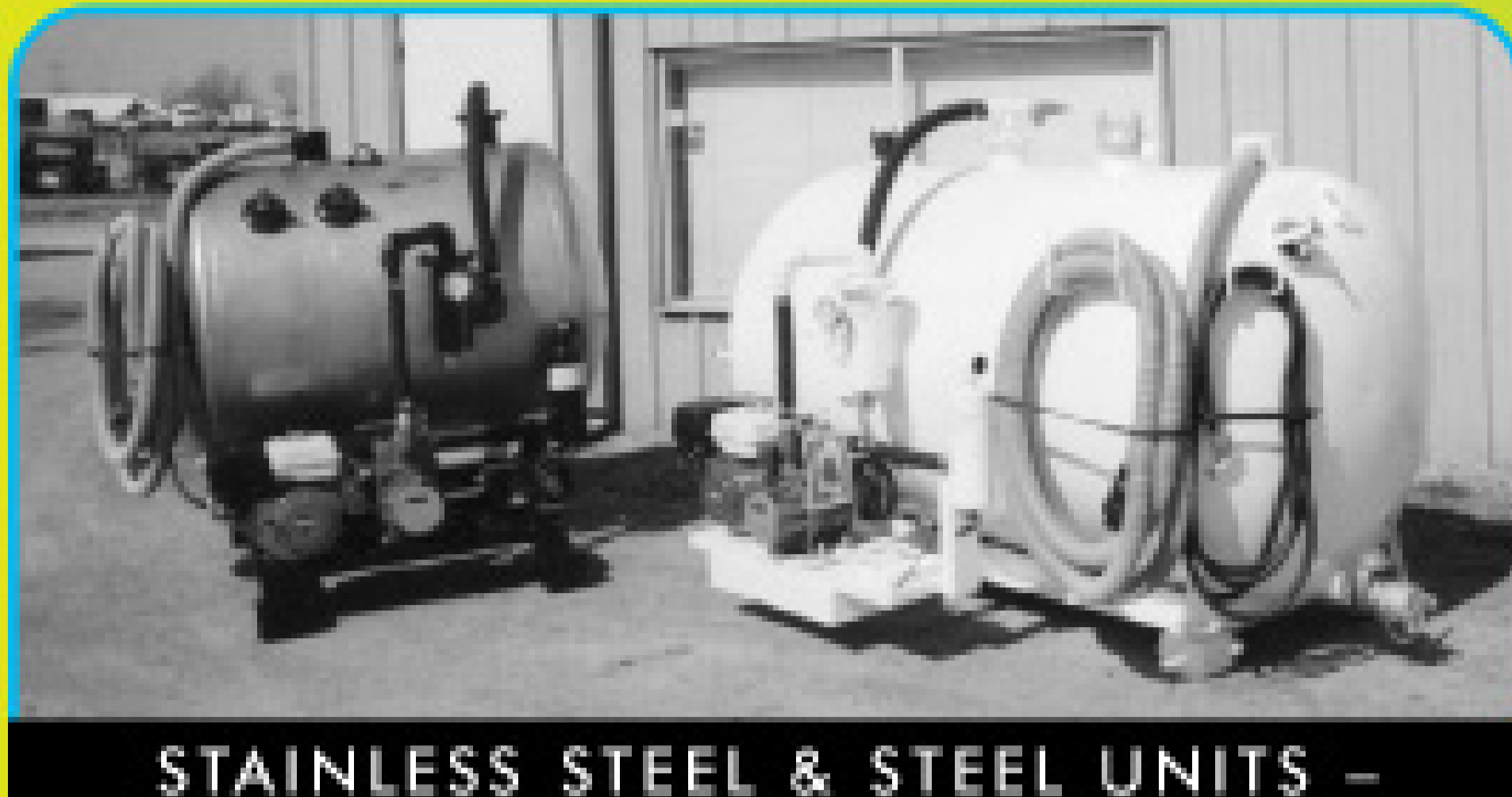

STAINLESS STEEL & STEEL UNITS - CALL FOR INFORMATION



TANKS MANUFACTURED TO YOUR SPECIFICATIONS

PUMP DISTRIBUTOR

- ✦ BATTIONI ✦ JUROP
- ✦ BOWIE ✦ MASPORT
- ✦ FRUITLAND ✦ MORO

Pump Rebuild Kits In Stock

CALL TODAY FOR INFORMATION OR PRICES ON TANKS, PUMPS AND ALL PARTS

Secondary Shutoffs

Sight Glasses, Valves & Couplings

12" Primary Shutoffs

21" & 36" Manways

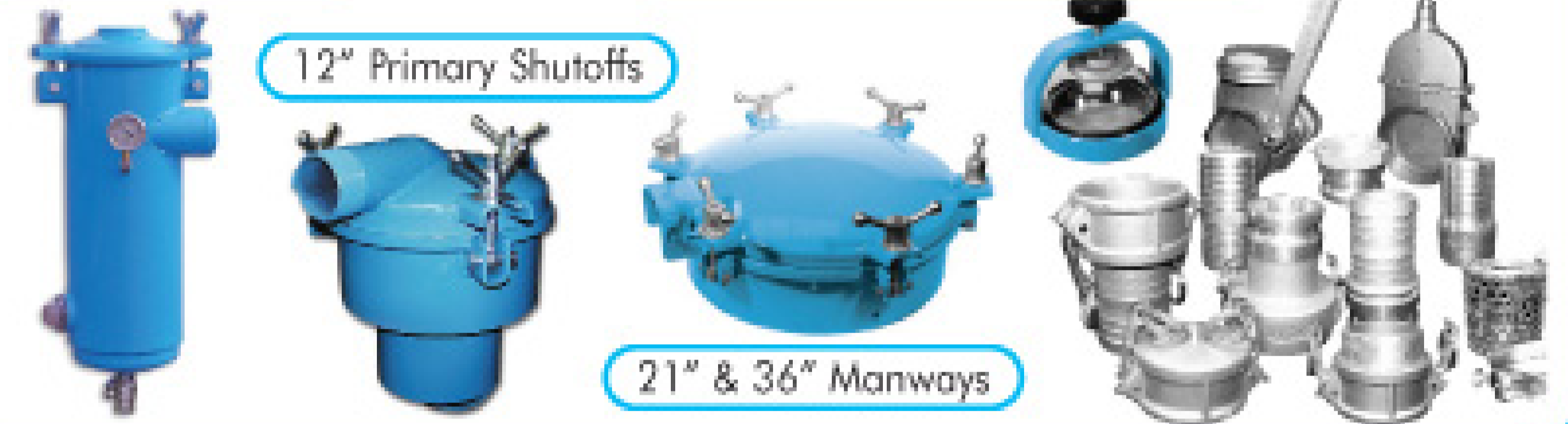

BASE TANKS INCLUDE:

1/4" Thick Steel • Pipe Reinforced Baffles • Primary Shutoff Flanged and Dished Heads • 21" Top and Rear Hatches Full Length Under Carriage on Bottom of Tank

BASE TANK PRICING

2100 GALLON.....	\$5800	3360 GALLON.....	\$8380
2500 GALLON.....	\$6690	3570 GALLON.....	\$8900
3000 GALLON.....	\$7350	4000 GALLON.....	\$9880



800.364.7307

2100 EAST BOOTH ST. • SEARCY, AR 72143
Fax: 501.279.0003 • E-mail: sbs@cdlworld.net

TUBELAND

Available in 6" & 8" Diameter

BUY NOW

"Vacuum Tubes" For Combination Trucks

TRUE TUBE

TRUEST TUBE ON THE MARKET

- Intakes

- Catch Basins

- Extensions

We Accept:

Thanks For Visiting Us!

Corporate Office: 1.800.666.0766 • Fax: 1.800.691.0031
www.uemsi.com • E-mail: info@uemsi.com

UEMSI

PIPELINE CLEANING & TELEVISIONING EQUIPMENT

PUMPER & CLEANER INTERNATIONAL ENVIRONMENTAL EXPO

Strong like bull.



The most durable and affordable restroom available, the Global from Hampel.

No bull.



Engineered for strength, durability and value.

www.hampelcorp.com • 800-549-1558

MTM Technologies presents the PRO Solutions Toolkit

Improve Your Quality... Lower Your Costs



Portable Restroom
Tracking



Fleet
Management



Service
& Delivery
Confirmation



Performance Reporting
to Maximize Efficiencies

Integrated with
Total Activity Control
CLEAR COMPUTING

www.clearcomputing.com • 888-332-5327

For more information
please contact us:

1.888.996.4276

www.microtargetmedia.com
techsales@microtargetmedia.com

Mark Your Calendar For

2009

February 25-28



Look on our website for more
information on next year's show.

pumpershow.com

800.257.7222

Irrigation fittings are for irrigating – NOT vacuum.
 How many dollars are you spending **SUCKING AIR?**
 Industry-proven, quality vacuum couplings from Bandlock
 will put money into your pockets.

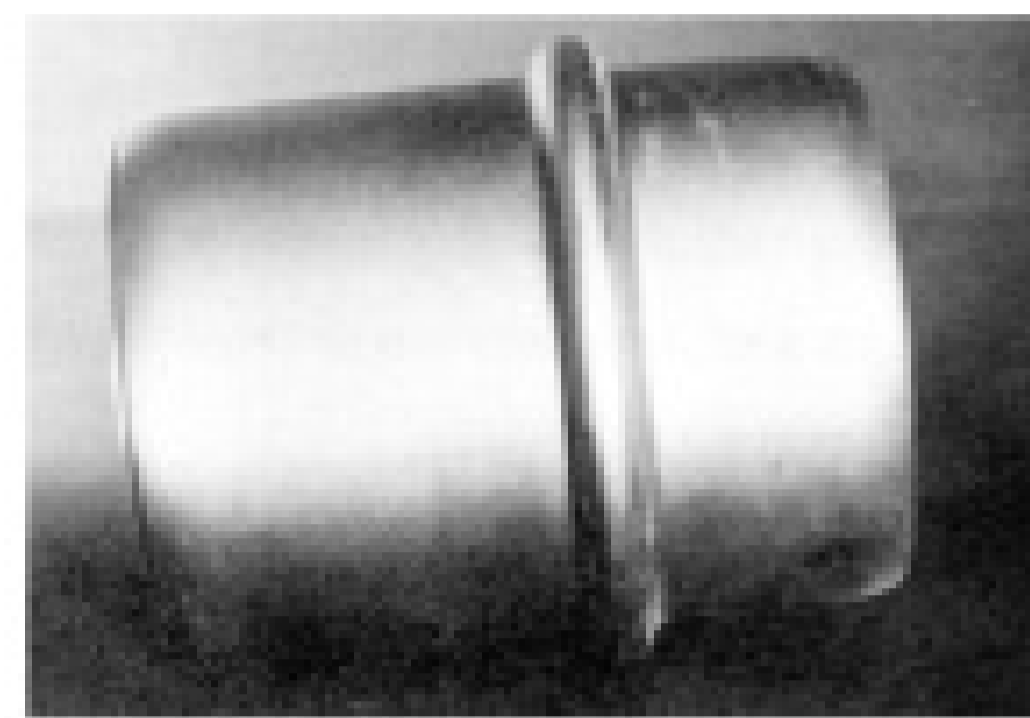

BANDLOCK BL
 4" to 12" MR Male Coupler



BANDLOCK BL
 4" to 12" FR Female Coupler



Aluminum Coupler RLM
 6" and 8" Aluminum
 Male Weldon



Steel
 Crown
 4", 6"
 and 8"
 Press
 End

**CLOSE TOLERANCE
 COUPLERS AND
 FITTINGS BRING
 "SAFETY" TO YOUR
 WORK PLACE.**

**Recognized
 as the
 #1
 Relief Valve
 in the
 World**



Aluminum Pipe with Steel Press Ends,
 Steel Pipe Weldons, Aluminum Weldons

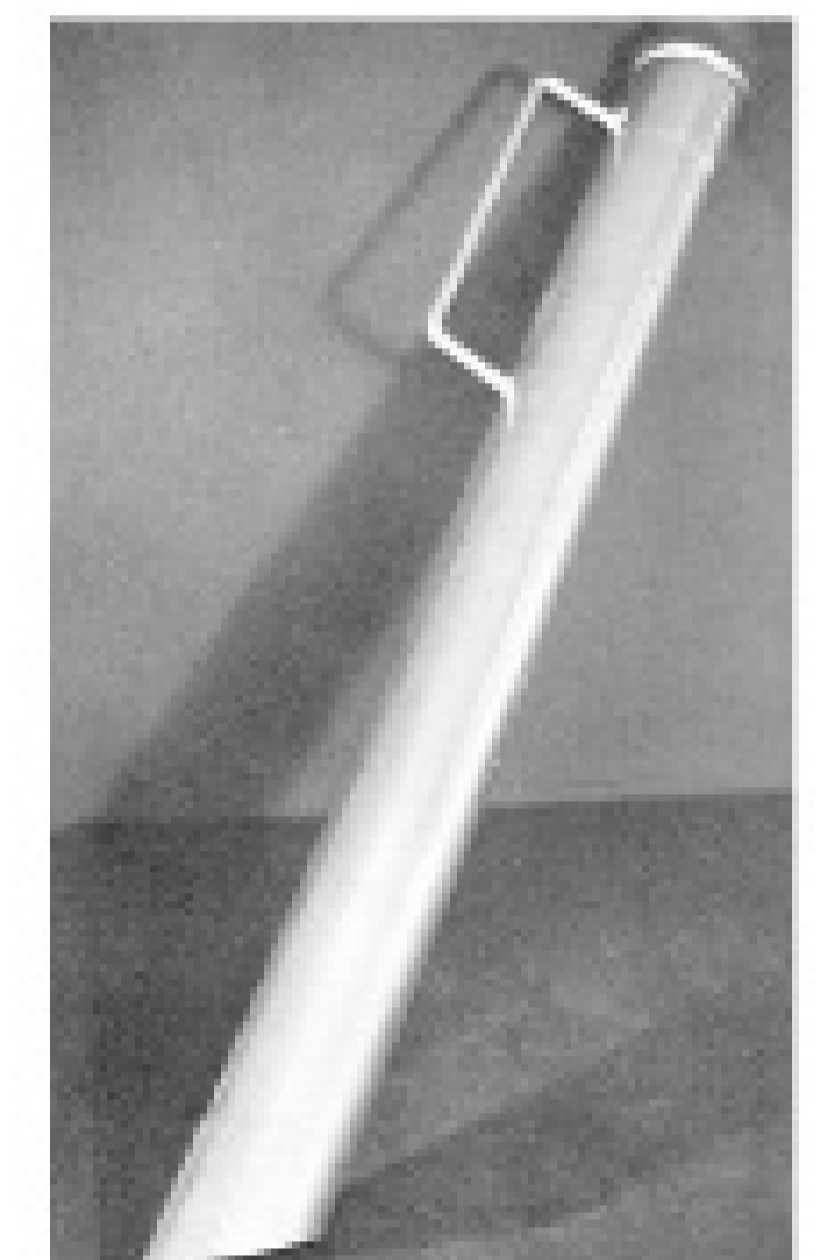

4" and 6" High
 Abrasive Bulk Nozzles
 Steel Reinforced



BANDLOCK Reducers
 BL-300
 All Size Combinations



Special "Y" Reducer
 Any Size



Special "Y" Plus Reducer
 Any Size



Special "Y" Plus Reducer
 Any Size



BANDLOCK "Y"s: BL "Y"
 4" to 12"



BANDLOCK Safety Discharge
 Female Coupler, Male Coupler
 BL-SFR 4" to 12", BL-SMR 4" to 12"



BANDLOCK Safety Discharge
 Coupler - Male Clamp, 2 Gaskets,
 Clamp with Safety Straps



BANDLOCK Clamp
 Standard and International
 BLB 4" to 12"

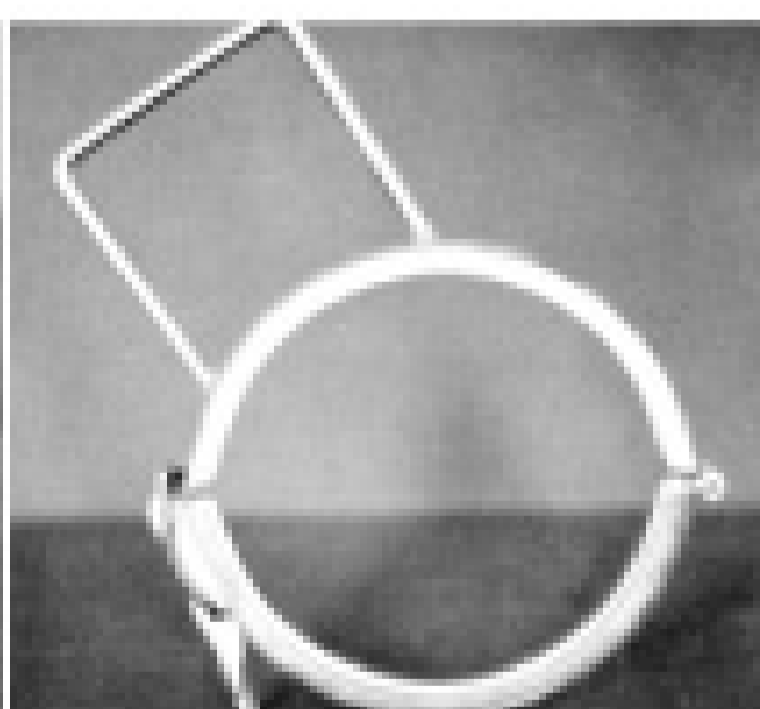

BANDLOCK
 EZ Lift Clamps
 BLB-EZ 4" to 12"

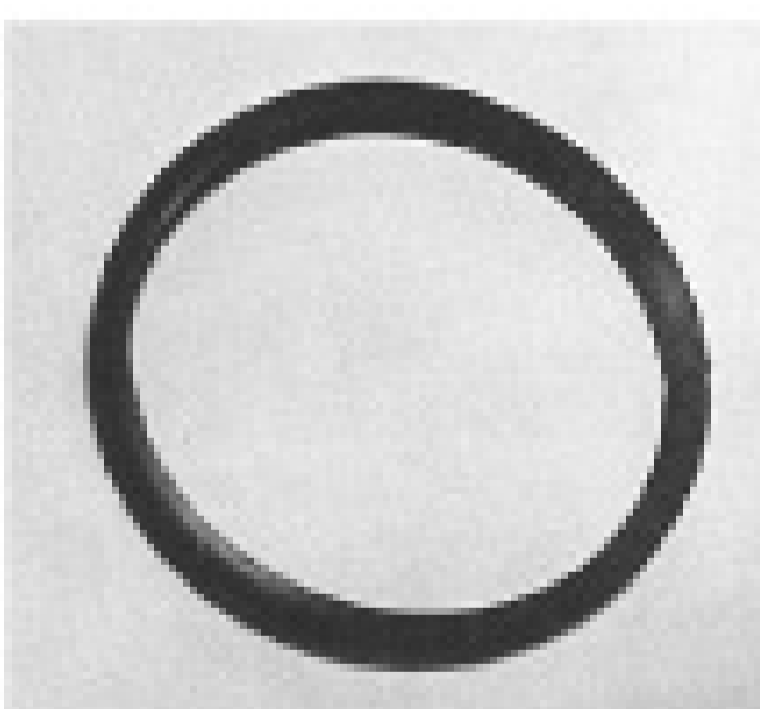

Profile Gaskets (Safety)
 4" to 12" Seals
 for Hazardous Materials



GO - 4" to 12"
 Rubber Gaskets



Male and Female
 BL-500M or BL-500F End Plug
 4", 5", 6", 8", 10" & 12"

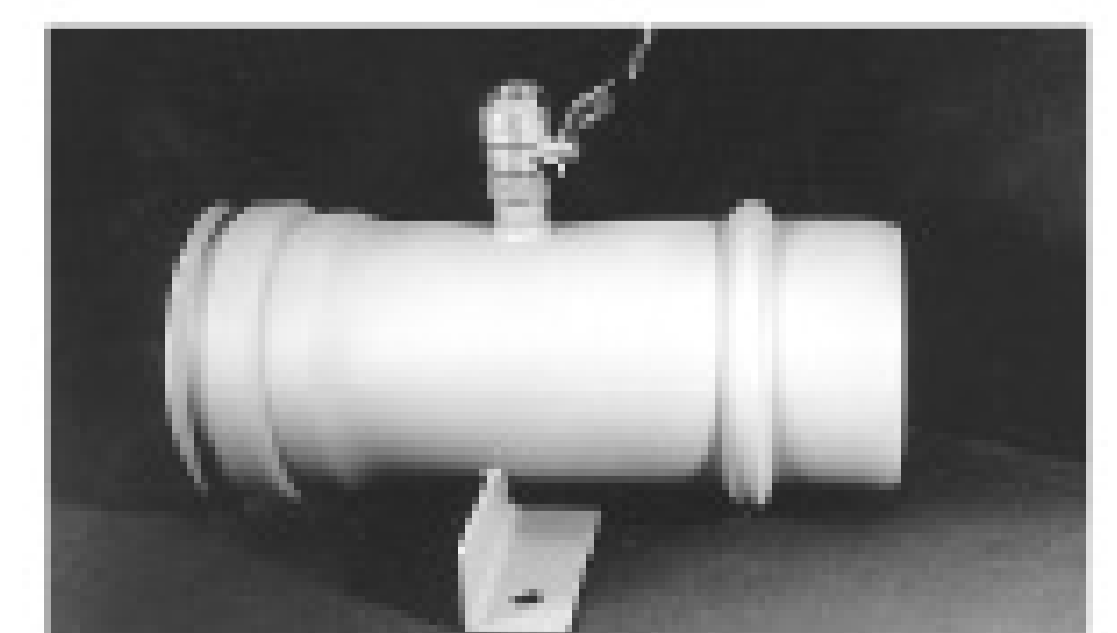

Wet Valve, 6", 360° Injected

BANDLOCK
 Corp.
 MADE IN THE U.S.A.

SUPERIOR "QUICK" CONNECT VACUUM AND PRESSURE COUPLINGS AND ACCESSORIES

Call or fax today to get your catalog!

1-800-659-2978

Fax: 909-930-2551

www.amesbury.com

jcario@amesbury.com

800.334.8237

With King Vac technology, the most difficult jobs become easy... without exception!



Just add an operator... and let the King Vac do the rest



*Visit our Website at www.keithhuber.com
or give us a call at Ph#1-800-334-8237*



Aqua-Zyme Disposal Systems

*"From the Grease Trap to the Garden"
- Dewatering & Composting -*

#1 Box on the market!

The ADS Dewatering System

is built by a pumping company for pumpers. You are welcome to come and watch the 30 yard box dewater 20,000 gallons of grease trap waste and/or septic tank waste in only 2 hours!

By using the ADS dewatering system along with our Compost Facility, we have turned our disposal costs into a profitable venture!

Call 979-245-5656 for Info!
\$ Financing Available \$

P.O. Box 489, Van Vleck, TX 77482 • www.aqua-zyme.com
1-979-245-5656 • zymme@aqua-zyme.com • U.S. Patent # 6,364,122

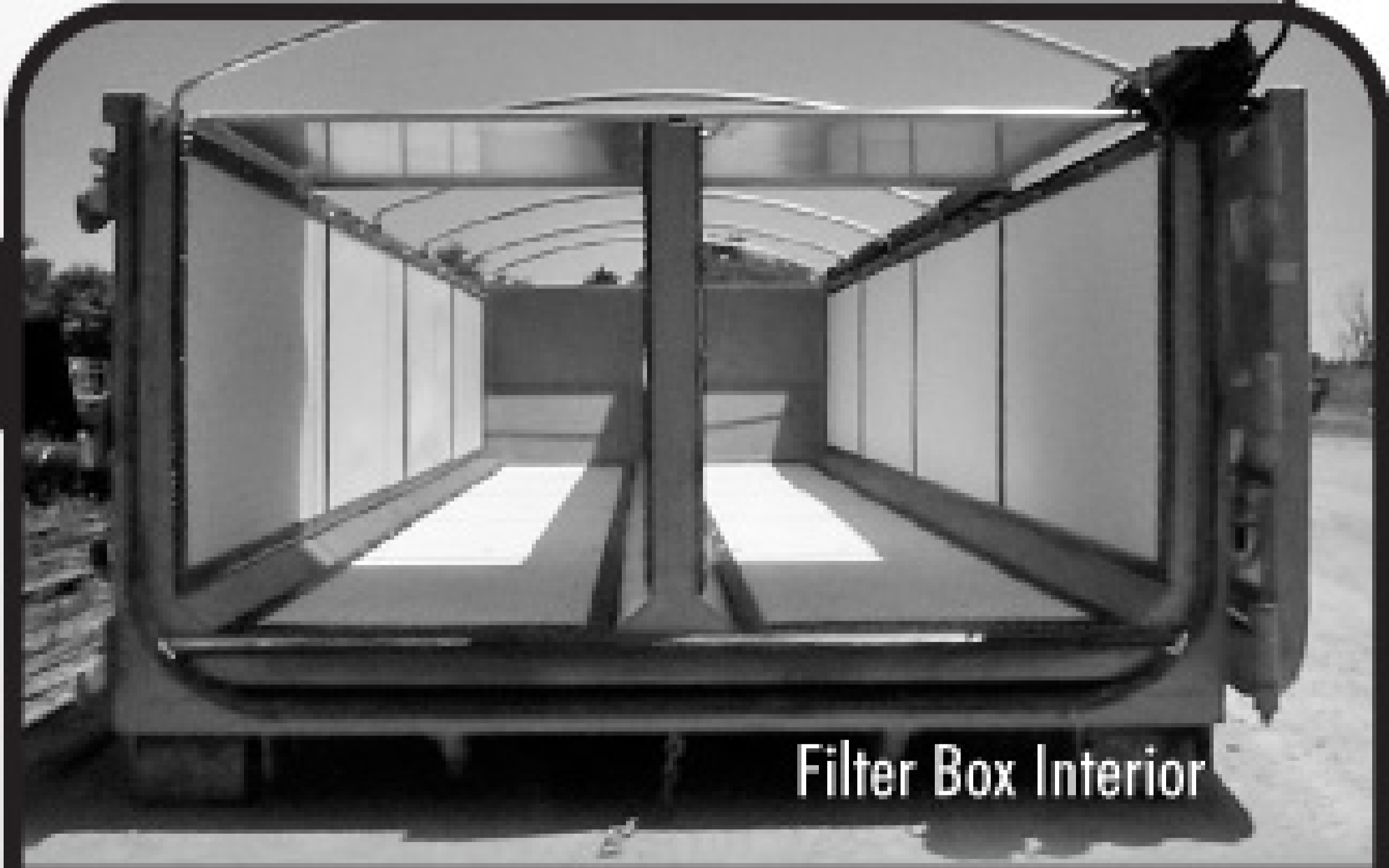

Filter Box Interior



Draining Down

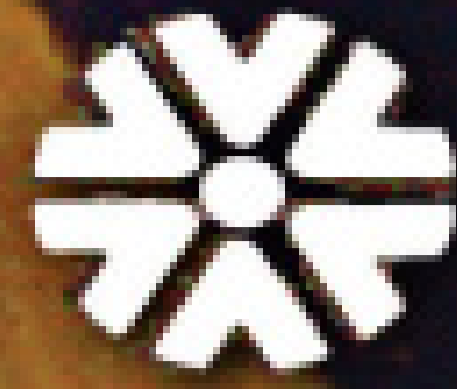

CENTER CAPITAL CORPORATION®

A Webster Bank Company*

Financing geared toward your business success.

THE INTELLIGENT CHOICE

FOR INNOVATIVE FINANCING SOLUTIONS

Environmental Equipment Financing Division Financing Geared To Your Business Success!

The Intelligent Choice For Innovative Financing Solutions

Center Capital's Environmental Equipment Financing Division offers equipment leasing and financing services tailored to the unique requirements of the waste management and environmental industries. Unlike traditional lenders, our sales team has expertise in both financing and waste management. We understand the kind of payment plans that make sense for your industry. We understand the equipment. We understand the day-to-day business issues you face.

When you work with Center Capital, you're partnering with professionals who understand your business and what it takes to help it grow.

We Cover 50 States!

PAYMENT PROGRAMS

STRUCTURED TO FIT YOUR NEEDS

VENDOR VALUE-ADDED

PROGRAMS

APPLICATION PROCESS

SIMPLIFIED

MORE INFORMATION

CONTACT

Robert A. Marino
Sr. Vice President



Thank you for visiting us in Louisville

Phone: 800-344-2224 • Fax: 215-542-1307
Website: www.centercapitalcorp.com

*Center Capital Corporation is a Subsidiary of Webster Bank, N.A., Member FDIC

You Can't Buy A Better Reel.

Hose Reels for Cleaning and Pumping

- ✓ High pressure washing and cleaning
- ✓ Sewer, septic, portable toilet cleaning
- ✓ Video pipeline inspection
- ✓ OE vehicles and aftermarket upgrades
- ✓ Extra rugged, long-lasting design
- ✓ Complete custom capabilities



Download or call for your FREE Guide to Ordering Pumper/Cleaner Reels
<http://go.hannay.com/U16>
877-467-3357

 **Hannay Reels®**
The reel leader.

Non-CDL
 19,500 GVW to
 66,000 GVW
 Septic / Grease Trap
 Portable Restroom
 Vacuum Service



Complete
 'Work Ready'
 Units Priced
 As Low As
\$66,200

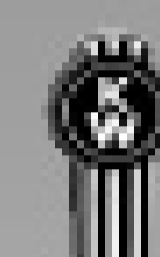
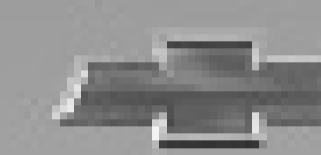
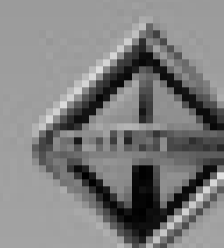

Contact: Mark C. Langworthy **800-261-9009**
 e-mail: mlangwor@tanktruckservice.com www.tanktruckservice.com
Tank Truck Service & Sales, Inc.
 25150 Dequidre, Warren MI 48091

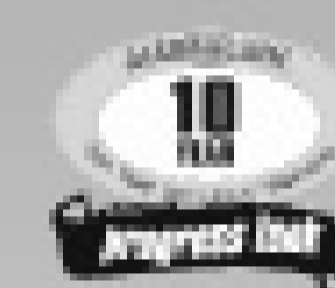

Septic-Scrub™

Used by More Professional Pumpers to Increase Their Business

Backed By Science ■ Proven with Experience ■ Many Satisfied Homeowners

Septic-Scrub™ is a superior product for the maintenance and restoration of septic system drainfields. Customers appreciate that it is environmentally safe, contains no organic chemicals and does not produce any toxic by-products. Most importantly, **Septic-Scrub works.** It breaks down sulfide buildup in the biomat and soil to allow for better water absorption.

Learn more about Septic-Scrub at www.arcan.com.

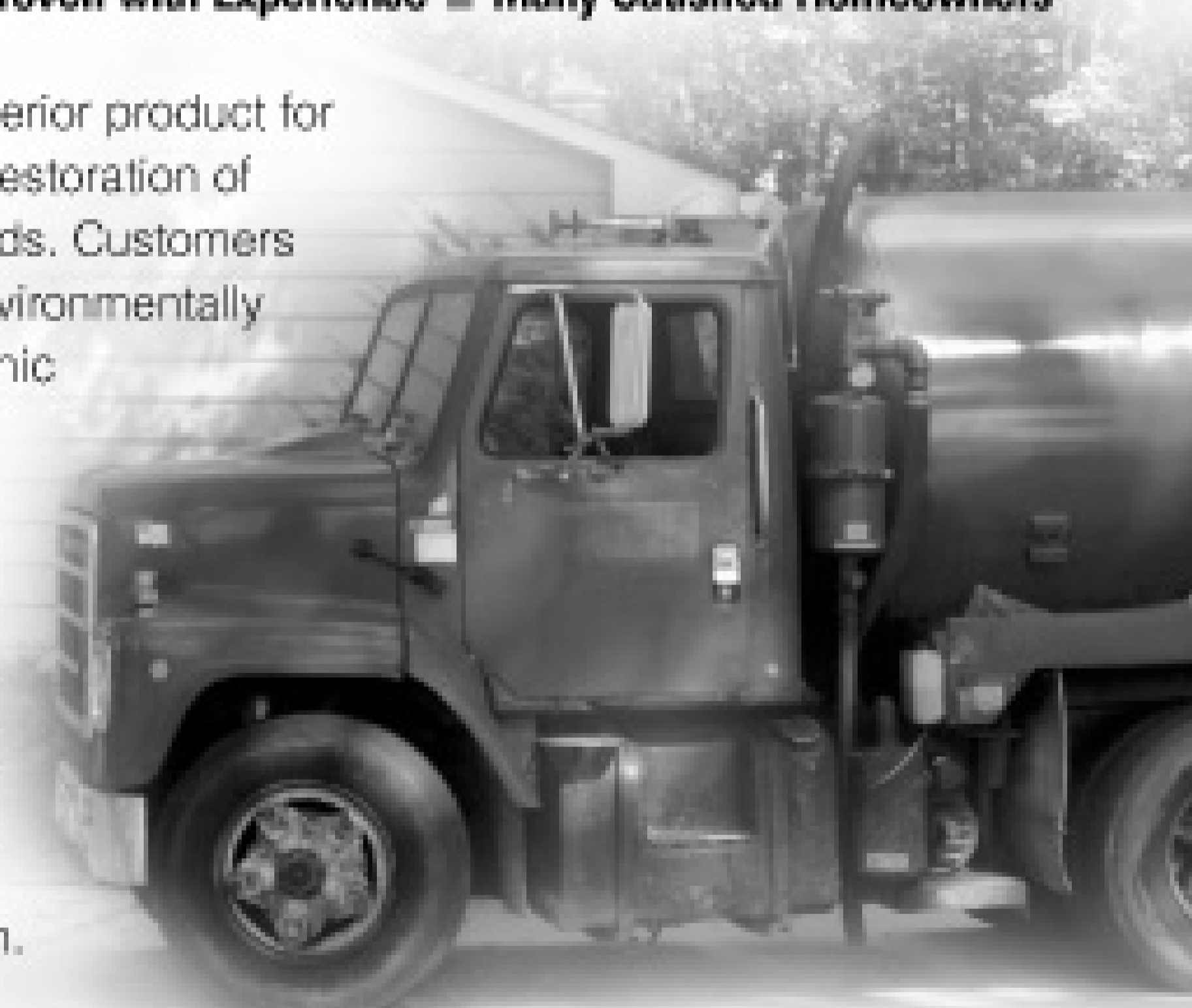

arcan

P.O. Box 31057
 Clarksville, TN 37040

For information on increasing sales and providing a valuable service to your customers, call Arcan Enterprises at **888-35ARCAN (352-7226)**

2008 V.E. Enterprises Eagle Vacuum Trailer



Why Choose A V.E. Enterprises Trailer?

Ten good reasons:

1. Built by ASME certified welders
2. All vertical welds are sub-arc welded providing 100% penetration
3. ASTM SA-36 grade 1/4" steel barrel, heads and baffles
4. Barrel padded with 1/4" plate at all contact points
5. 4" channel ring supports on barrel
6. 4-wide hose troughs with added bracing for pumps
7. Wedge shaped sump with 4" butterfly valves extended close to bumper
8. Trailers prepped with steel shot blast creating a 2.5 mil anchor profile
9. Dual EZ access side / rear entry to walkways (optional)
10. Built for and by our customers with over a dozen design improvements in 2007

* ASME & non-code bobtails / trailers available from 80 to 200 barrels

Setting the Standard For Liquid Storage and Transport Markets Since 1987.

800-234-2329

www.veenterprises.com
sales@veenterprises.com

10834 St. Highway 53 • P.O. Box 369 • Springer, OK 73458

VE
ENTERPRISES, INC.

Employee Motivation is Job One

Follow these four steps to raise the level of enthusiasm and feeling of job satisfaction among your workforce

By George Hedley

I used to get tired of trying to get my people to do what I wanted them to do. They always had what appeared to be legitimate excuses why they didn't get the job done on time, or why they didn't follow my directions, or why it wasn't their fault when something went wrong out on the jobsite. I thought I was the only one who could do the job right. Perhaps, you feel the same some days.

PEOPLE ARE DIFFERENT THAN YOU

There is a way to build your pumping business with the people you have. You can get them motivated, all on the same page, and working like a winning team with common goals, drive, and excitement. Successful business owners and managers know their people are different than them. They realize employees are not motivated for the same reasons they are. Just because you pay employees a good wage doesn't mean they're going to work their fanny off for you.

Younger workers today are very different as well. They like continuous learning and personal growth in their careers. Their loyalty is to themselves. It is your job to discover each employee's differences, what makes them tick, and help them achieve their goals in order for you to reach your business goals.

THE MOTIVATIONAL PROBLEM IS YOU

Years ago, I went through 14 secretaries over a two-year period. I just couldn't find anyone who would work as hard as I wanted them to. One day I finally realized maybe the problem was me! I had to take responsibility for motivating my staff. Once I realized this fact, my personnel problems turned around, our people became great and our employee retention improved to more than 90 percent every year.

To motivate your workforce, you've got to give them a reason to be motivated. Don't expect others to understand your passion for customers, quality work or the need to make a profit. They must want to follow your vision, achieve your goals, and get the job done properly.

Exceptional employees require two things — money and happiness. Money includes fair pay and competitive benefits, plus working for a strong company with a good reputation in the

community. Happiness is the same, being motivated. Your job is to motivate your people to want to do what you want them to do. You accomplish this with inspirational leadership, clear and continuous two-way communication, an exciting vision, step-by-step directions, holding people accountable and giving them full and unquestioned responsibility.

Four proven steps to motivate people:

1. Outline clear expectations

People need to know exactly what you want them to do and the results you want them to achieve — the expected results. Weak managers assume people understand what's required. The norm is to tell people to work real hard and try your best. But, this doesn't let people know exactly what's expected. People must be told and understand exactly what you want, the specific end results.

Be specific with clear targets and define the exact results you want. Make sure your people understand what their individual targets are, what's acceptable and what's not, when they hit or miss their target, consequences for not achieving the results you want, and rewards for a job well done.

2. Give regular recognition and praise

The second important step is to provide ongoing recognition and praise for people who do the work. Weak and ineffective managers don't take time to thank people for a job well done. Over time, this causes lackadaisical employees and poor results. In a survey of why people left their company, over 90 percent said they'd never been recognized or praised by their boss.

Employees want and need feedback and positive reinforcement for their efforts. Effective leaders give out praises at least every week to everyone in their sphere of influence. Use words like, "I appreciate you" and "Thanks for a great job." Keep a simple chart in your day-timer to ensure you recognize all your staff on a regular

George Hedley is owner of Hedley Construction and Hardhat Presentations, a speaker on business-building topics and the author of The Business Success Blueprint Series. To reach him, call 800/851-8553 or visit www.hardhatpresentations.com.



Your job is to motivate your people to want to do what you want them to do. You accomplish this with inspirational leadership, clear and continuous two-way communication, an exciting vision, step-by-step directions, holding people accountable and giving them full and unquestioned responsibility.

basis. Strive to praise everyone at least weekly and check it off on your chart so you won't forget someone. Verbal praise works the best, but occasionally write handwritten notes to those who went beyond the call of duty.

3. Share a clear understanding of the big picture

The third thing your people need is a clear understanding of the big picture (company, employees, customers, projects, etc.) and how they fit in. Successful business owners, managers, and supervisors are open and honest and tell employees where their company is going — its vision, what the future has in store, positive and negatives, and changes or adjustments required to be successful. People need to know what's happening; otherwise, they tend to think the worst.

Successful leaders constantly tell the real deal — business is good or bad, the future is positive or negative, sales are up or down, productivity is acceptable or not, our people are doing a good job or not. Hold semi-annual, all-company meetings plus monthly project and department meetings where the big picture is discussed and open to questions.

4. Promote a caring company attitude

Let your people know you care about them. Employees need to know you appreciate their contributors to the company success. They want to know you care about their personal goals, future, personal development and their family. People must know they're important. They want to know they will be listened to and have a say in the future of their company.

To ensure you continuously show you care about your employees, keep a "team member profile" sheet on each person in your day-timer. Include their name, family members, schools, hobbies, sports, interests, goals, challenges, contributions, etc. This way you can refer to it on a regular basis and keep track of each team member's life. ■

1-YEAR, 100,000 MILE ENGINE WARRANTY NATIONWIDE • COMPARE OUR TRUCKS AND PRICES TO ANYONE



2001 MACK VISION
4500 gal US Tanks, Double Frame, Tag Axle Ready To Work \$74,000



2005 MACK VISION
In Production 8 Units To Choose From 3600 To 4000 gal Starting \$78,000



2003 MACK VISION
4500 gal US Tanks, Double Frame, Loaded Show Truck



2003 MACK CH
4000 gal US Tanks, Double Frame, Low Miles 300K, Jetter System

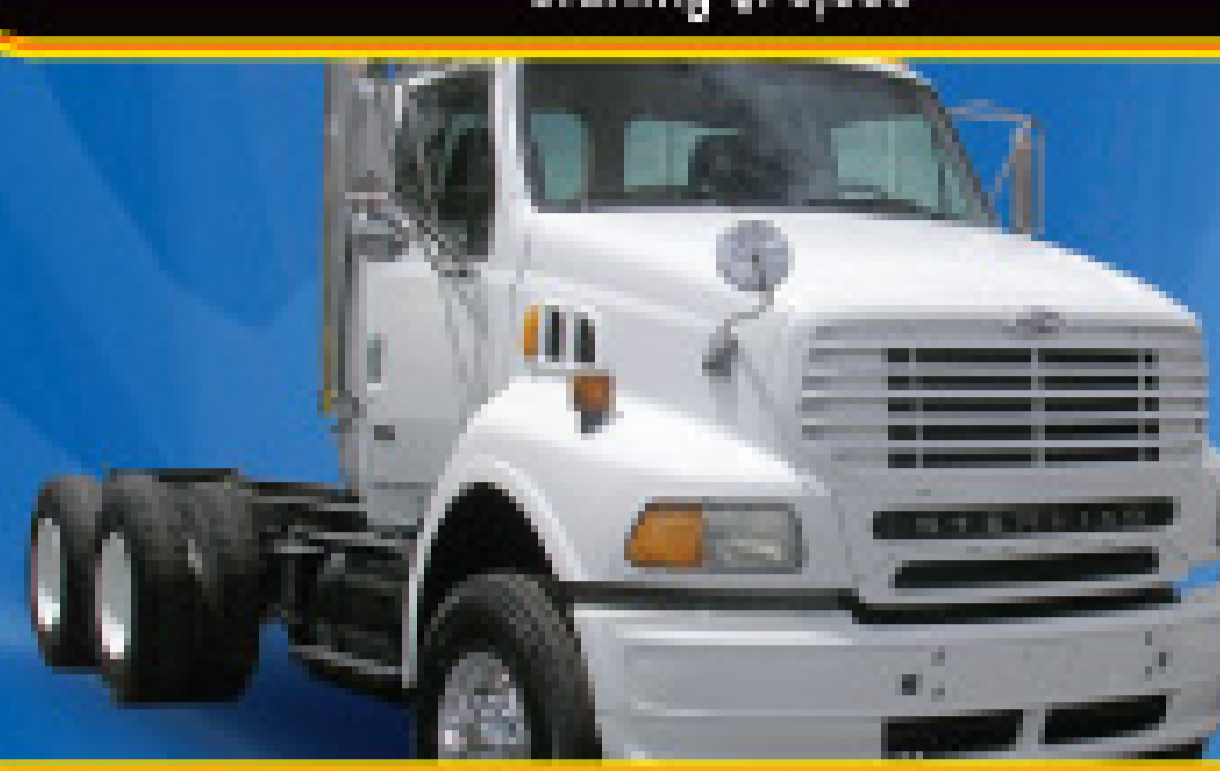

2000-2001 STERLING
In Production, 3600-4000 gal US Tanks, Pick Your Colors



2001 STERLING
4000 gal US Tanks, Double Frame



2000 FREIGHTLINER FL 112
3600 gal US Tanks, Low Miles 249,937, Double Frame, \$59,500

IN PRODUCTION
2005 MACK VISION
4000 GAL, 46,000 LB Camel Back
2005 MACK VISION
3600 GAL
2001 MACK CH
4000 GAL DUMP
2000 STERLING
4000 GAL



2000 STERLING
4000 gal Dump US Tanks, In Production, Pick Your Colors



2000 FREIGHTLINER FL 70
2200 gal US Tanks, In Production, Pick Your Colors, \$45,500



2001 MACK CH
3600 gal US Tanks, Water Cooled Pump LC 420, \$61,000

SOLD



THANKS TO R C C A WELD SERVICE

**Jettors,
Digital Level
Indicators &
Heated Valves,
No Problem**



THANKS TO RUDYS PLUMBING SERVICE



THANKS TO C & C SEPTIC



THANKS TO PORTOSAN



THANKS TO SEPTIX

Please Call
For More Info

ISRAEL VERA:
305-525-6406

New Salesman

GEORGE GONZALEZ:
954-558-0816

OUR 28TH YEAR

NATIONAL TRUCK CENTER

9750 N.W. 27th Ave. | Miami, FL 33147

Phone: 305.691.8407 | Fax: 305.691.8416

www.nationaltruckcenter.com

★ **WE EXPORT OR DELIVER** ★

**U.S.
Tanks**
THE TOP DOG OF
VACUUM TANKS



wallenstein

portable sanitation

**The most rugged, dependable,
longest lasting vacuum pumps
in the industry!**

- > Quality construction
- > Rugged design
- > Wide fiber vanes
- > Easy internal access
- > Low noise level
- > Two year warranty



Model 302



Model 402

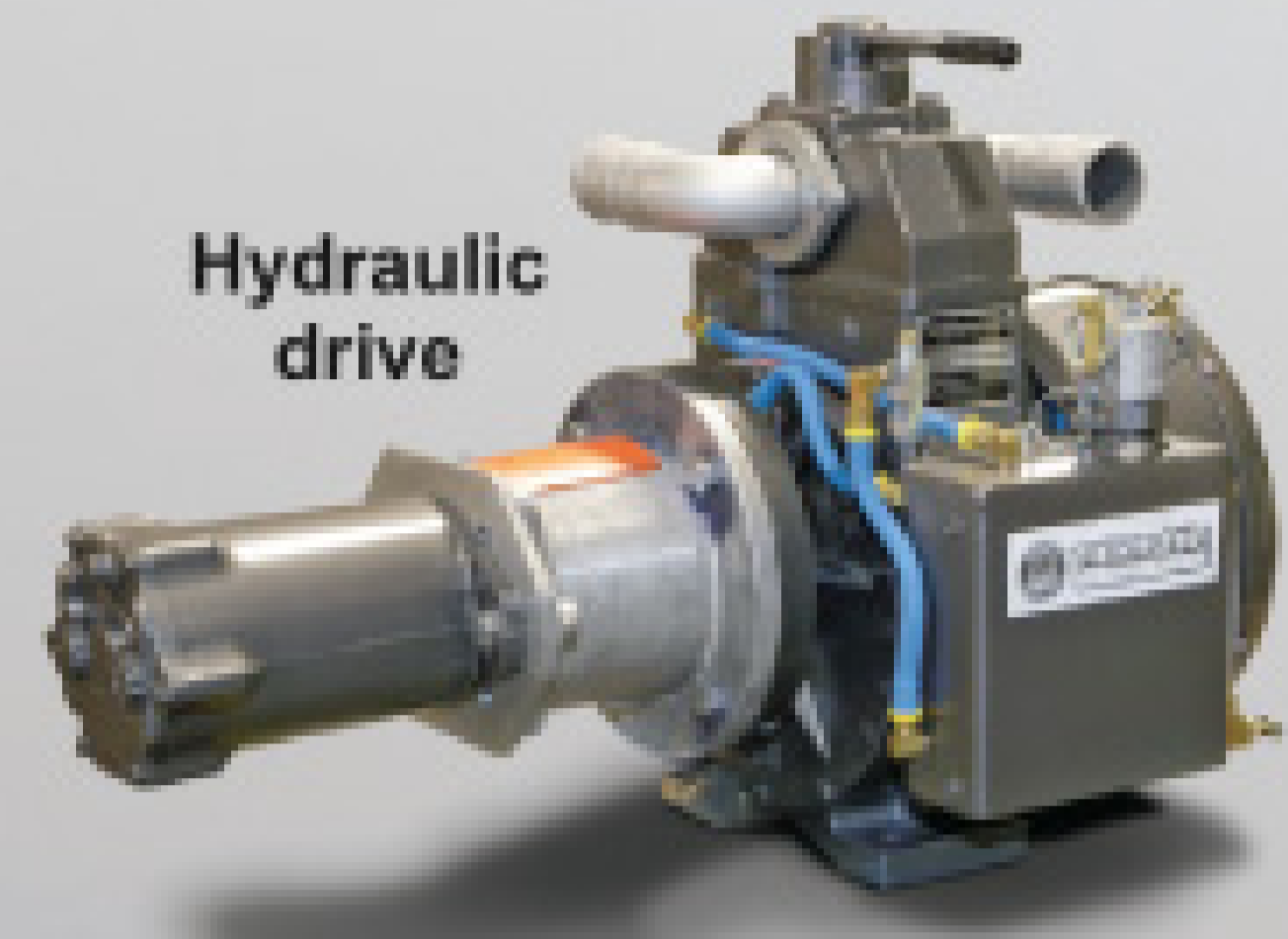

Hydraulic drive

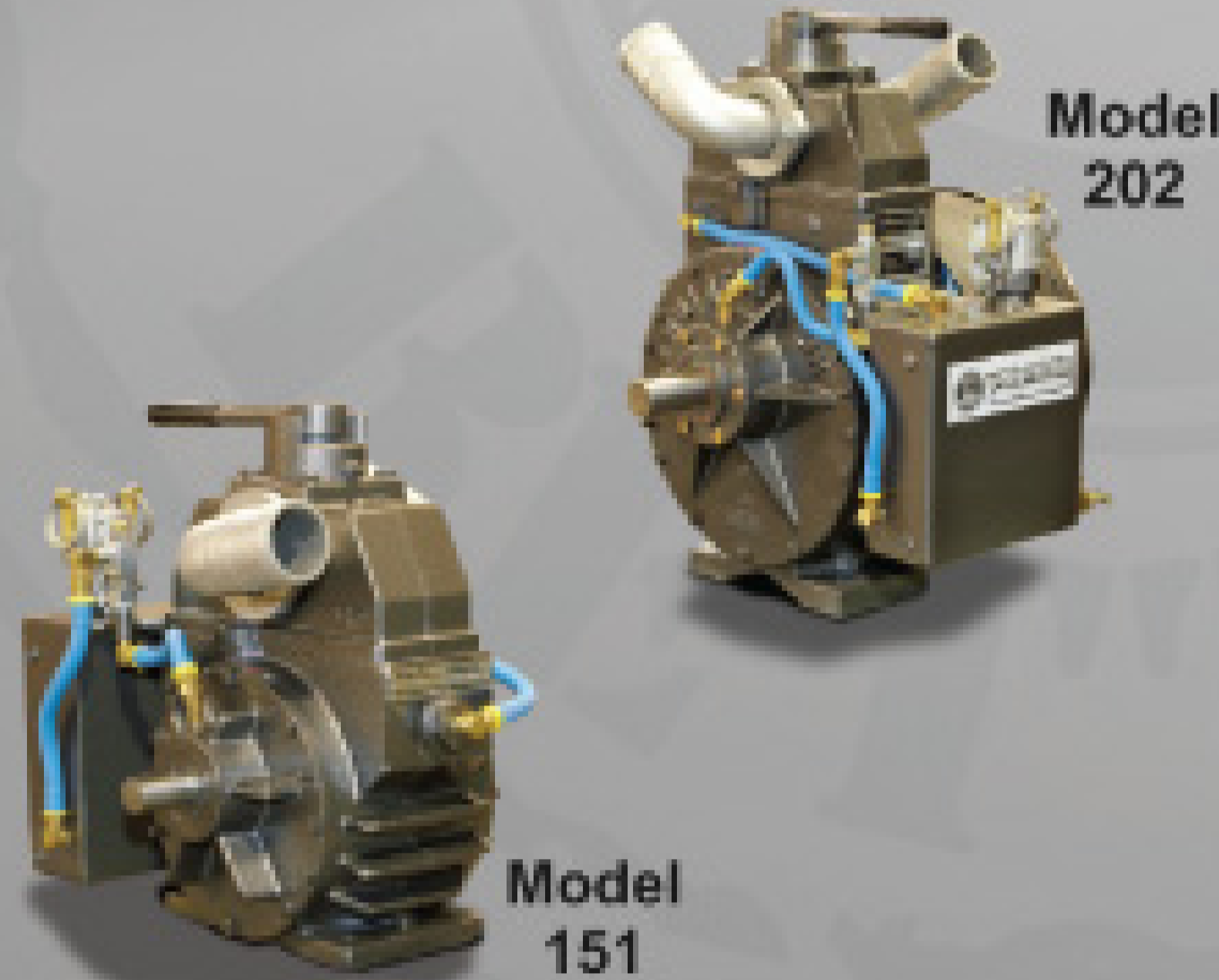

Model 202



Model 151

**CALL FOR PRODUCT LITERATURE AND
YOUR NEAREST AUTHORIZED DISTRIBUTOR**

Series	Rating CFM	Vacuum *HG	HP ^{min} or ^{total} Engine	Tank Size US Gallon
151	80 @ 1750	27	5.5	500
202	115 @ 1150	27	11	750
302	165 @ 1150	27	13	1100
402	200 @ 1150	27	18	1500+

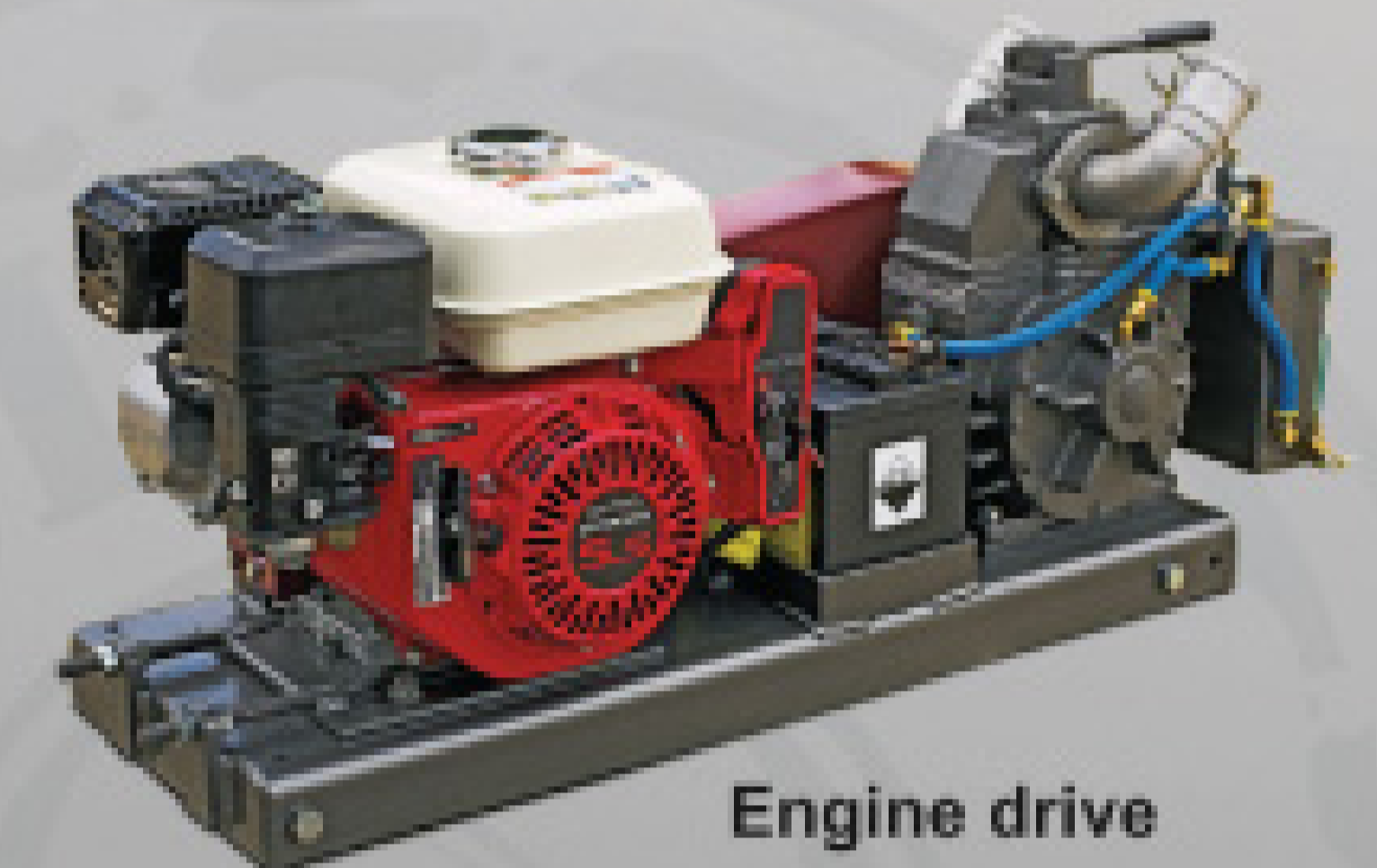

Engine drive

Toll Free 1-800-801-6663 fax 519-669-8331 email info@wallensteinpumps.com

SmithCo

SIDE-DUMP TRAILERS

SIDE DUMP

Call 800-779-8099
www.sidedump.com

30902 C38
Le Mars, Iowa 51031



Thanks for visiting us!



CP-20 Offroad



SHV Series



DT Series



MHV Series



S Series

*Manure, Slurry, Sludge, Green Waste, Food Residuals, Compost, SmithCo Hauls it All.
Stock Pile, Spread, Stability, Selection, Service...SmithCo*

NEW! 2008 Sterling Bullet

Cummins 6.7 Liter Turbo Diesel-305 HP
6 Speed Automatic, 7,000 lb. Front / 13,500 lb.
Rear Axle, Exhaust Brake, AM/FM-CD, Cruise.

1000 Gallon **PORTAVAC**

650 Waste / 350 Fresh
Single service, Masport HXL4,
Burks DC10 washdown, Hot Shift P.T.O.

\$67,900

Monthly lease from... **\$1316.**

4 Wheel Drive \$72,500

Tank sizes from 800 to 1500 Gallon

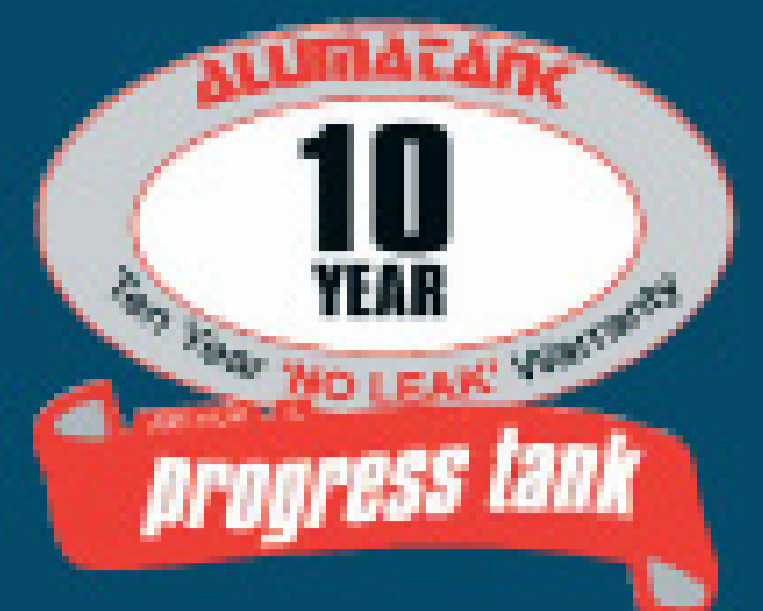

**200 Services
FREE DEODORANT**

With Purchase Of Your
Toilet Truck or Slide -In

800 Gallon Combo Unit

10' Bed with Liftgate
2007 Ford 550 XLT
Upgraded interior.



\$72,230 Monthly lease from \$1,446

NOW IN STOCK!

New from **progress tank**

SLIDE-IN VAC UNITS

300 Waste / 135 Fresh
Masport or Conde pump
Honda electric start
12 volt water pump
Totally self contained!

\$8,495



3600 Gallon **ALUMATANK**

Masport HXL15, 360 CFM Pump, Tool Box

2008 Peterbilt 340

Cummins diesel,
10 Speed Transmission

\$104,900

Plus FET
Lease -To-Own
from... \$1,330 mo.



Aluminum Vacuum Trailer

6300 Gallon
1 Compartment
Aluminum wheels

from... **\$62,000**

Plus FET



2008 International Durastar

215HP, M7 V8 diesel: **\$77,495**

230 HP, DT466: **\$84,900**

Allison auto trans, air brakes, 10,000 lb front,
tilt wheel, AM/FM vertical pipe AC, heated mirrors.

2000 Gallon **PORTAVAC**

500 fresh / 1500 waste
Masport HXL 4 w/ pre-filter, Burks wash down,
Hot shift PTO w/remote, 4" Discharge,
Unit hauler and tow package.



Flexible Financing Options To Fit Your Needs.

TRANS LEASE, INC.

Randy Satrom or
Cassie Bergo

877-600-6423



Distributor of: **Masport**

KeeVac
Industries Inc.

Call Kevin. Call Matt. ...Just Call KeeVac

866-789-9440

www.keevac.com



Kevin Keegan
31 Years Experience

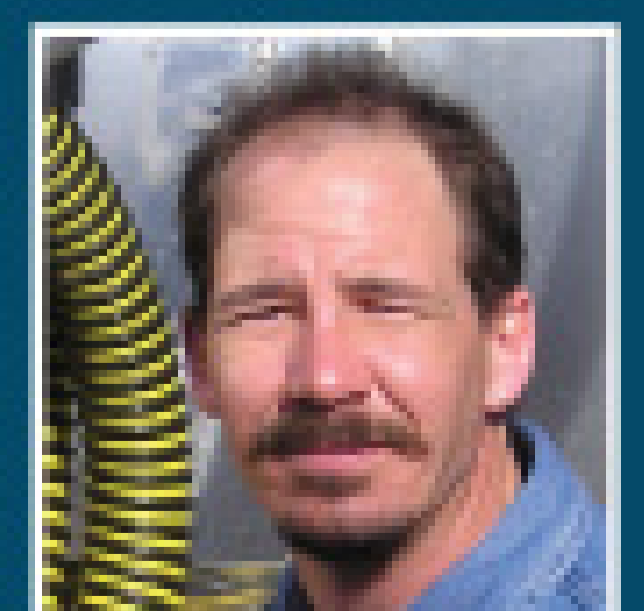
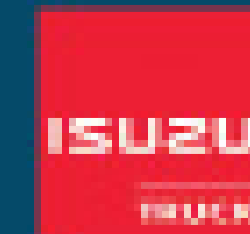

Matt Crowell
17 Years Experience

The Solution For All Of Your Aluminum Vacuum Tank Needs



5 YEAR WARRANTY ON NEW TANKS



Thanks for visiting us!

IN STOCK

7000 Gallon aluminum trailer, full length fender/hose trays, 60,000# Watson Chalin air ride suspension, polished aluminum wheels
\$56,000 + FET

IN STOCK

3,800 Gallon aluminum tank on 2000 Freightliner chassis, with Jurop PNR 142 vacuum pump, \$64,900 tax included

Longhorn Tank Co.

P.O. Box 1147 Gravette, AR 72736 800-422-9840 479-787-7910

Dewatering Equipment



Use The Right Equipment To Get The Best Results.

- Liquid Reduction = Reduced Transportation Costs
- Dewatering = Reduced Tipping Fees
- Non Organic Separation = Facilitate Land Application of Liquids



Designed for Simplicity. Engineered for Durability.

Toll Free: 877.855.4890

info@accentmanufacturing.com • www.accentmanufacturing.com

Seal it Tight! Seal it Easy! Seal it Fast!



RISER: Dual-wall plastic culvert pipe.

Inner safety lid.

- Easy 10 minute installation!
- Secure fit for all systems!
- Made & sold by septic installers!
- Prevent ground water infiltration and save money at the same time!



Apply foam sealant to tank.



Place ring over opening and apply foam.



Place plastic maintenance pipe on ring.



Install lid.

Are you tired of using risers that are too tall or too short for the job you are completing? Plastic riser pipe will give an exact height each time. Try our system and you will never have to carry concrete pipe and lids again. Save time by not having to assemble multiple sections.

- Seal-R® Lids Available in 12", 15", 18", 24", 30", 36".
- Seal-R® Rings Available in 18", 24", 30".
- Inner Safety Lids Available in 18", 24".

Seal-R® Lids can be personalized. Seal-R® Lids are constructed with UV stabilizer to resist degradation from exposure to sunlight.

For more information, call us today!

BrenLin Company, Inc
Manufacturers of Seal-R® Products
Herman, MN
888-606-1998

Fax 320-677-3001 • Email brenlin@brenlin.com

www.seal-r.com

Supplying your Business for Seasons of Success



- **One-Stop Shopping**
Our wide selection of products makes shopping at several different places for all of your needs a thing of the past.
- **Very Competitive Pricing**
- **Huge Selection**
We carry a wide selection of portable restroom parts and accessories to take care of all your needs. Including toilet parts, pumps, pressure washers, hoses, valves, fittings, tank components, chemicals, dispenser systems, hand sanitizer, deodorizers and odor control products, engines, sink parts, cleaning supplies, and much much more.
- **Two Locations for Faster, More Economical Shipping**
Our warehouses in Utah and Georgia are strategically placed to service every state.
- **Custom Pump Trucks**
If you can imagine it, we can build it. We pride ourselves on our ability to work with our customers and design an efficient and effective pump truck designed around your custom applications.



**CALL TODAY for your
FREE product catalog!**



Thanks for visiting us!

1-888-935-1133

www.toico.com

YOUR ONE STOP SOURCE FOR PORTABLE RESTROOM PARTS AND SUPPLIES



Comfort Elite Mobile Restroom Trailers



See what over 50 years of trailer manufacturing experience can do for a restroom. See what the other guys will be trying to keep up with next.

Ask Us About Our NEW:

- ◆ GPS Monitoring System
- ◆ Negative Ion Air Purifiers
- ◆ Lead Referral Program
- ◆ Corian Countertops
- ◆ New Platinum Edition
- ◆ ADA Units
- ◆ Arctic/Winter Packages

Effective **Solutions.** Uncompromising **Quality.** www.wellscargocog.com **888.574.4222**

POWER



1-800-758-4788

Vacuum Pumps & Tank Parts at
WHOLESALE PRICES!

Juop

PRODUCTS

INC.



PN84
• 252 cfm @ 18"
• Air Cooled

PN 23, 33, 58, 84, 106
IN STOCK.



LC20
• 425 cfm @ 18"
• Liquid Cooled



R260
• 304 cfm @ 18"
• Ballast Port Cooling

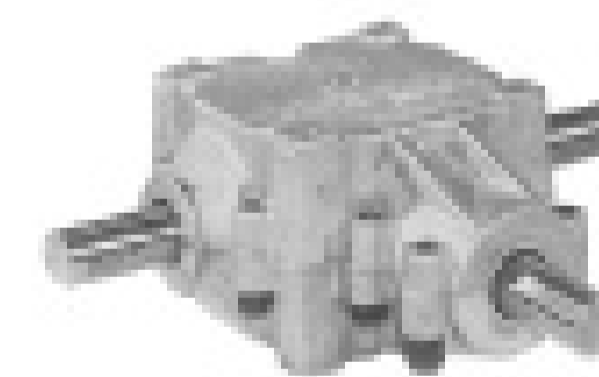

RT Angle Gearbox
1" - \$199
1 1/4" - \$299

Lever Action Gate Valve

Brass
2" - \$10
3" - \$98
4" - \$157
6" - \$288



Piston Action Gate Valve

Brass
4" - \$69
6" - \$183

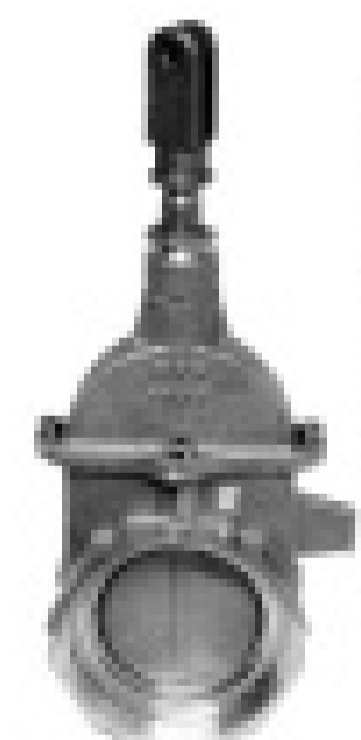

Secondary

Nylon/Brass
2" - \$160
3" - \$206



Manway Special Gasket in lid

20"
35"

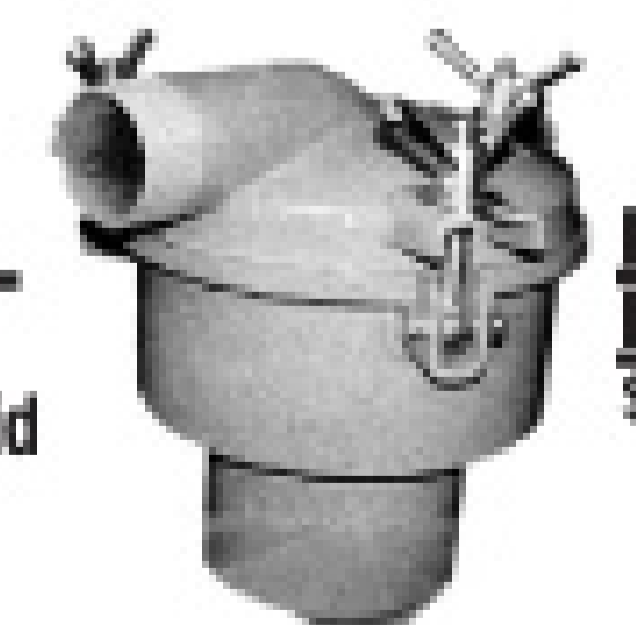
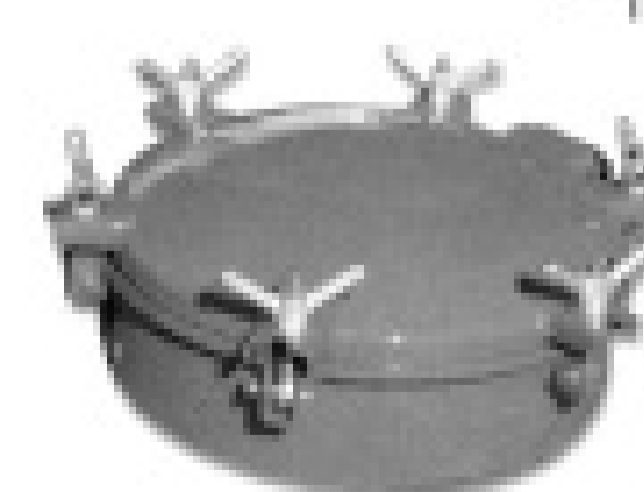

Low Pro Primary

\$295

POWERFLO MODEL:	PF330	PF540
Air capacity displacement	258 cfm	300 cfm
Air capacity displacement @ 15" Hg	248 cfm	290 cfm
Minimum vacuum	95%	95%
Minimum pressure	30 psi	38 psi
RPM	1200	1200
Weight	308 lbs	357 lbs

Performer Series PF540

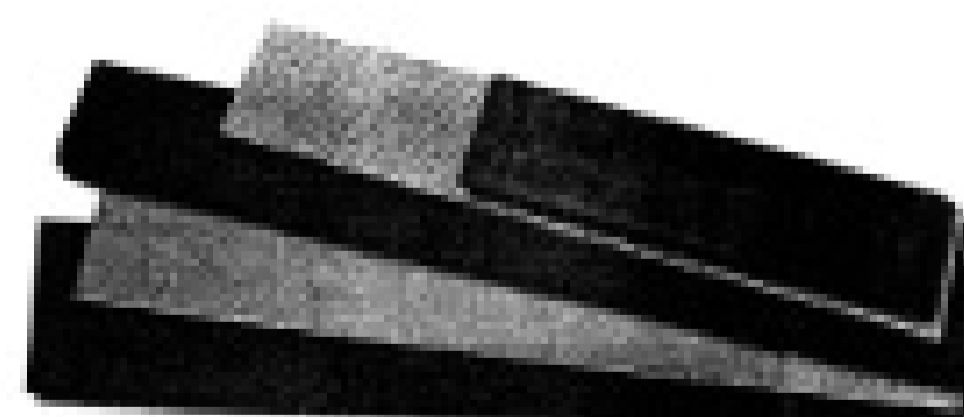

Dura-Comp Pump Vanes

Exclusive manufacturer since 1991. 400 non-asbestos material. Long lasting, self lubricating, satisfaction guaranteed!



DC-10

Heavy-Duty Washdown Pump

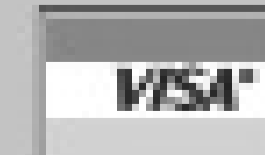

POWERFLO PRODUCTS INC. • 2755 N. Gaviota Ave. • Signal Hill, CA 90806 • Phone: 562-997-0720 • Fax: 562-997-0724

HOUSE OF IMPORTS **TRUCK SALES**

▶▶ SINCE 1947

▶▶ WWW.HOUSE-OF-IMPORTS.COM

CALL ANGEL AT:
786.258.3384
OR
305.691.4778

EXTRA CLEAN USED TRUCKS WITH NEW TANKS!



2005 PETERBILT
4,000 GAL. TANK - 2008 SHOW TRUCK



2004 MACK
5,000 GAL. TANK - THANK YOU MR. GARY



2001 FREIGHTLINER
4,000 GAL. TANK - THANK YOU BRENT

100,000 MILE LIMITED FACTORY WARRANTY

▶ DELIVERY ▶ EXPORT ▶ PUMP WARRANTY: 1 YEAR ▶ TANK WARRANTY: 5 YEARS

ENGINE & ACCESSORY, INC.

Toll-Free: 1.800.327.5431

Tel: 305.573.2268

Fx: 305.576.4617

www.eamfg.com



Engine & Accessory is your one stop shop for all of your vacuum truck needs. Delivering the best possible customer experience.

Benefits include:

- ISP Program - In stock tank and truck program
- Direct access to all major chassis manufacturers
- State of the art manufacturing facility complete with service shop
- Extensive parts inventory and complete product support
- Full engineering capabilities using the latest technology
- Knowledgeable sales staff
- Customizable units with a broad range of options
- Nationwide product delivery
- Complete package of financing and lease options



2007 Ford F750 - 2000 gallon tank (1500/500) - Low work station - Masport pump system - Several Available

Several Pre-Emission Units Available

Many 2007 Pre-emission Fords and Isuzus available for Portable Restroom Service Units.



Aluminum vacuum trucks. Sizes range from 2000-5500 gallons with many pumping system options available.

Call Today!



Spec your Industrial Unit. Options for Hoist and Full open rear doors. DOT Code and Non Code.

Call Today!



Steel vacuum trucks. Sizes range from 2000 - 4000 gallons with many pumping system options available.

Call Today!

CLEAR COMPUTING with **INSIGHT**

Total Activity Control Street Eagle GPS

TACTrackerPRO Garmin Updates

1988 - 2008

20

YEARS OF
EXCELLENCE

- Vehicle Tracking
- Work Order Updates
- Service Verification
- Production Reporting



Clear Computing
(888) 332-5327
www.clearcomputing.com

Insight USA
(301) 866-1990 x201
www.mds-inc.com



Thanks for visiting us!



toll free:
(866) 457-5425

EXPLORER Toilet transporters

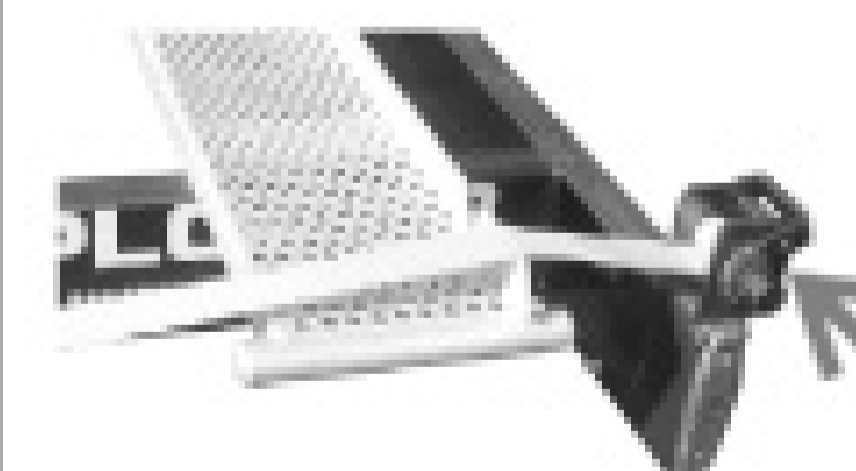

Secure Transportation for portable toilets with wooden or plastic skids!

POSI-STRAP

POSI-CLAMP

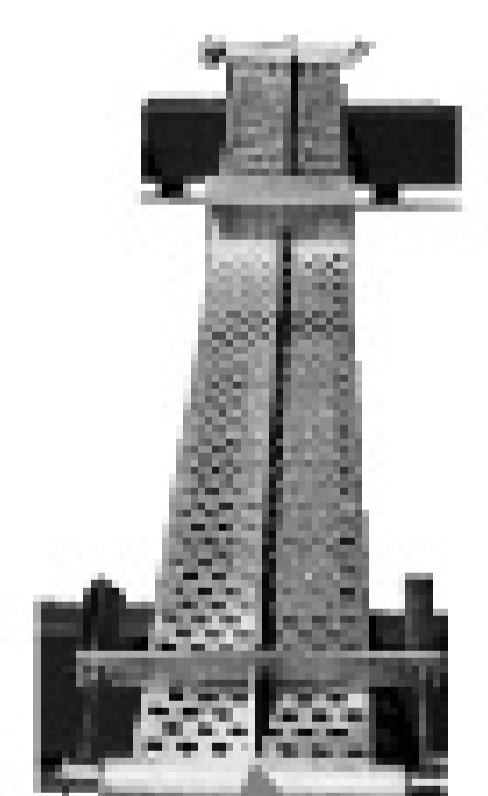

Florida	Texas	California	Colorado
STEVE BAE ENTERPRISES Tel: (407) 709-8175 Fax: (407) 822-3998 Apopka FL	WOYT ENTERPRISES Tel: (903) 586-6493 Fax: (903) 541-0874 Jacksonville TX	PLUMAS SANITATION Tel: (530) 832-0370 Fax: (530) 832-0373 Portola CA	Columbia Sanitary Tel: (303) 526-5370 Fax: (303) 526-0686 Golden CO

Manufactured by:

McKEE TECHNOLOGIES INC.
ELMIRA, ONTARIO, CANADA N3B 2Z7

\$ WE'VE GOT THE MONEY \$

For All Your New and Used Equipment Needs



CHUCK TERRITO

- > APPLICATION ONLY TO 250K
- > SIMPLE APPROVAL PROCESS
- > LEASE OR LOAN OPTIONS
- > NEW & USED EQUIPMENT
- > FLEXIBLE FINANCE OPTIONS
- > START UP PROGRAMS



MIKE RAUSCH

Fax this E-Z application to **406.892.5072**, or give us a call, and we will get your financing approved for the show.

Company Name: _____ Owner/Contact: _____

Address: _____

City: _____ State: _____ Zip: _____

Phone: _____ Best time to call: _____

Let us put our 35 years of experience to work for you!

Call today and see why...

IT PAYS TO LEASE WITH US!



Granite Leasing Co.

800.246.7997

www.graniteleasing.com

PORTABLE TOILET
SERVICE UNITS
SLIDE IN UNITS
HOISTED UNITS
ROLL OFF UNITS
CUSTOM UNITS

www.pikrite.com

Do Your Shopping At Pik Rite and Save



Manufacturing & Sales - 60 Pik Rite Lane - Lewisburg, PA 17837

1-800-326-9763



Thank you for visiting us in Louisville

THE service program

Simple Software for Your Service Solutions

The Leading QuickBooks® add-on Software for today's Portable Sanitation Business.

- Interface with QuickBooks®-The Service Program generates your recurring route billing and seamlessly allows you to print the invoices in QuickBooks®.
- Easily Manage Routes
- Track Pick-Ups & Drop-Offs
- Palm and Windows PDA Handheld Support w/Remote Sync
- Works with Mapquest®
- Track Inventory at Multiple Locations
- 30-Day Money Back Guarantee-Leasing Available



Thanks for visiting us!

866.480.1879
www.theserviceprogram.com

AMT

A Subsidiary of The Gorman-Rupp Company™

12 VOLT DC HIGH HEAD WASHDOWN PUMP

- 1 HP Washdown Duty Motor for Severe Operating Conditions
- Investment Cast 316 Stainless Steel, Cast Iron or Cast Bronze Construction
- All Models Equipped With High Efficiency Stainless Steel Impeller
- Discharge Port Rotates in 90° Increments
- Four Front Drain Plugs
- Maximum Flow 56 GPM
- Maximum Head 80 Ft. (35 PSI)
- Maximum Temperature 200° F



The AMT 12 Volt DC Washdown Pumps are designed for pumper, septic service, OEM, and marine applications requiring a DC motor. The motor has a one hour duty rating and is furnished with a grade 303 stainless steel shaft. Washdown Duty Pumps are available in a variety of construction and seal materials to meet your specifications. Pull-from-the-rear design for easy servicing without disturbing piping.

Call us toll free at 888-268-7867 or visit our website www.amtpump.com for more information.

American Machine & Tool
A Subsidiary of The Gorman-Rupp Company
400 Spring Street
Royersford, PA 19468



The initial hunt is over, but the season is just beginning

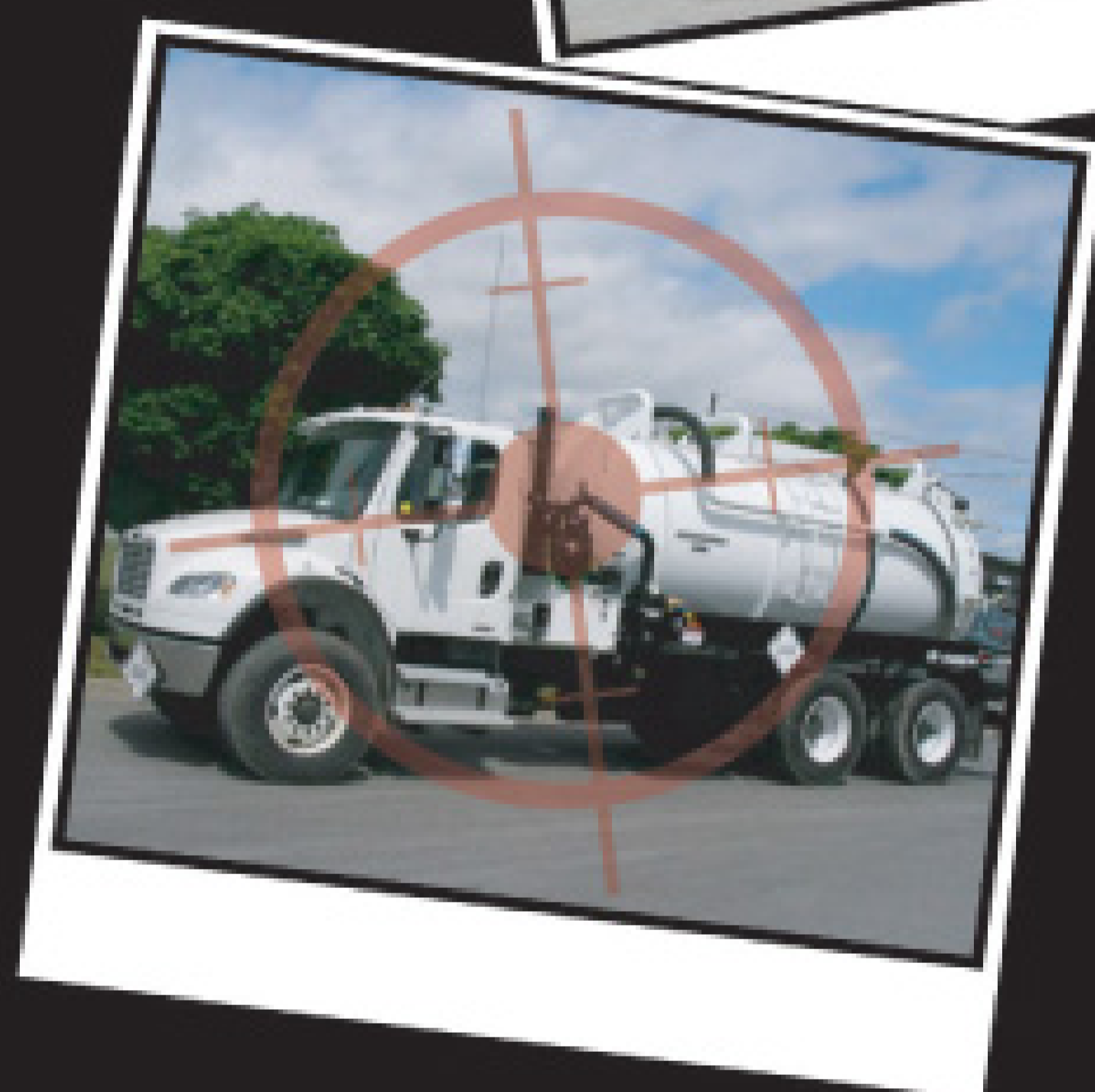

Just because you did not bag your truck in Louisville doesn't mean that the hunt is over. Jack Doheny Supplies can help you land your perfect truck no matter what the season. So to continue the hunt, log onto www.dohenysupplies.com and follow the links to keep the hunt alive.

Jack Doheny
Supplies 

*"World's Largest Distributor of Sewer Cleaning,
Air Handling and Street Sweeping Equipment"*

Call Jack Doheny Supplies
to schedule your hunt

800-336-4369

www.dohenysupplies.com

Experience Matters.

Custom vacuum tanks built to your specifications.

For nearly 50 years, our tank builders have been setting the industry standard for innovation and value. Everything we build is customized to your exact specifications. Start with a bare tank and add only the options that are suitable for your application. What about service? Our technicians can rebuild pumps or furnish parts such as vanes, seal kits, housings, and rotors for most pumps. Whatever you need, let us put our experience to work for you.



Bare tank w/no attachments

Bare Tank:

Prices are for the tank only with no openings, hatches, rails or other attachments. LMT can furnish items for you to attach to your tank at additional cost. Please call for more information and pricing.



Basic tank w/optional manway and hoses

Basic Tank:

Prices include primary shutoff, full length rails (straight or tapered), 4" discharge nipple, and 3" intake nipple.

Check out some of the options:

- ✓ Manways (20", 25", 36")
 - ✓ Full open door (2 types)
 - ✓ Primary & secondary shutoffs
 - ✓ Valves for loading & unloading
 - ✓ Oil catch mufflers
 - ✓ Suction hose & couplings
 - ✓ Mounting rails & kits
 - ✓ Vacuum pumps (Jurop, Masport, Moro, Fruitland, and others)
 - ✓ Hosetrays and hangers
- And more...

LMT Basic & Bare Tank Prices:

(subject to change without notice)	Basic Tank	Bare Tank
1500 gallon: 54" dia. x 12' long w/1 baffle.....	\$ 4,345.....	\$ 2,958
2000 gallon: 60" dia. x 14' long w/2 baffles.....	5,406.....	4,037
2500 gallon: 66" dia. x 14' long w/2 baffles.....	6,145.....	4,753
3000 gallon: 68" dia. x 14' long w/2 baffles.....	7,162.....	5,728
3500 gallon: 72" dia. x 17' long w/2 baffles.....	8,660.....	7,138
4000 gallon: 78" dia. x 16' long w/2 baffles.....	9,784.....	8,226
4200 gallon: 78" dia. x 17' long w/2 baffles.....	10,272.....	8,689

Custom sizes up to 6000 gallon are available.

All lengths are can length excluding flanged and dished ends. All tanks over 70" dia. have 2 braces of 2" x 3" solid steel to prevent collapse of tank. All tanks are cleaned with an acid solution and prime painted. We can also customize the paint color for an extra fee. Tanks are manufactured with mild steel and are welded with submerged arc process for the best strength and appearance. Stainless steel is available at extra cost.



Call us at 800-545-0174 before you buy!

LMT Inc. - Custom Vacuum Tanks

Tel: 309.932.3311 • Fax: 309.932.3155 • info@tanksandpumps.com

www.tanksandpumps.com

		<p>1-800-333-9274 East * 1-800-786-9274 Custom 1-800-351-7283 HONDA Parts * 1-800-964-9274 1-800-454-9274 Open Till 7:00pm West</p>				<p>* Apply For 30 Day Terms Account * Low Interest Lease Plan * 5 Offices To Serve You * Free Lifetime Tech Support</p>		
SWIVELS <p>Mosmatic & Super Swivels \$22.10 & Up</p>	BYPASS VALVES <p>From 500-7000PSI 120 Models In Stock \$19.99 & Up</p>	TRIGGER GUNS <p>Extreme Duty From \$7.99 & Up</p>	HOSE REELS <p>200' Manual Reel \$79.99</p>	Portable Hose Reels <p>250' \$299 350' \$349</p>	HOSES <p>Up To 5800PSI 316Deg F. Rated Up To 200' \$29.99 & Up</p>	TURBO NOZZLES <p>Up To 6000PSI Best Seller 4500PSI Only \$39.99</p>	PRESSURE GAUGES <p>Stainless Steel Industrial Quality Up to 6000PSI Only \$23.99</p>	BALL VALVES <p>Ball Valves Brass, Steel & Stainless Steel New 6000PSI Stainless From \$23.99</p>
Honda Engines <p>* 5Hp GC \$199 * 6.5Hp GX \$349 * 8Hp GX \$459 * 9Hp GX \$489 * 18Hp GX \$1,099</p>	Honda Twins <p>* 18Hp GX610K1 \$1,099 * 20Hp GX620K1 \$1,279 * 24Hp GX670T \$1,599</p>	Compact Electric Hand Carry <p>\$649 EHC2015G 2GPM @ 1500PSI</p>	Compact Honda Hand Carry <p>Includes Pulse Valve \$799 HJ3028HC 3GPM @ 2800PSI</p>	Hose Reels All Types Available <p>200' Portable As Shown \$165.98</p>	LT Replacement Engines <p>Recoil & Electric Start Available</p>	CAT Pump Volume Distributor <p>Complete Pumps Plumbed From \$179</p>		
Customized Electrics <p>Auto Stop/Start Hose Reels, Etc</p>	BEST Sellers ALWAYS on Sale <p>5.8GPM @ 4000PSI \$399 8.0GPM @ 3500PSI \$499 7.0GPM @ 5000PSI \$599 Call For Free Quotation. We Also Stock Pumps With Left Hand Drive, Tapered Shaft, Car Wash Duty, 316 Stainless Steel and Unique Applications 1-800-964-9274</p>	High Performance AR Pumps <p>13GPM @ 1450PSI \$579 11GPM @ 3000PSI \$629 5.8GPM @ 7250PSI \$1,099 10GPM @ 7250PSI \$2,899 44GPM @ 1500PSI \$4,199 We Stock 1000's of Pumps For Same Day Shipping!</p>	New On Board Hose Reel Option <p>50' x 100' Available On Some Models</p>	Hose Reels Up To 350' Capacity <p>Jetter Packages Available All Sizes</p>	Replacement Pumps <p>1-800-454-9274 Up To 41GPM Up To 7250PSI</p>	Replacement Coil Specialists <p>For Hot Water Pressure Washers</p>		
Truck or Trailer Mount <p>Skid Mount & Tank Feed Options Available On Some Models</p>	Hydraulic Drive Pressure Washers <p>3.0GPM @ 2000PSI \$539 4.0GPM @ 2200PSI \$649 4.0GPM @ 3000PSI \$689 Call For Details & Hydraulic System Requirements 1-800-454-9274</p>	Cleaning Heads <p>Full Line Of Cleaning Heads Available</p>	Up To 8GPM Hot Boxes <p>Adjustable Thermostats, Jumper Hoses & Options Available L.P. Diesel Models Available</p>	HONDA Best Seller <p>\$2,999 4000PSI Hot 4040HG-115</p>	Frames & Frame Parts Available <p>Belt & Direct Drive With Custom Options</p>	Mobile Wash - Detailer System <p>Self Contained On Board Water Supply</p>		

WHAT DO YOU NEED TO STOCK YOUR BUSINESS NOW?

- lower payments...
- longer terms...
- less interest...
- deferred payments?

Why limit your options to inflexible delayed payment plans when you can choose the options that are best for you?

FLEXIBLE FINANCING* on trucks, restrooms and hand-wash stations enables your money to work harder for your business.



POLYPORTABLES

Call your regional manager at **(800) 241-7951**.

Onsite Systems Get a Bad Rap in Georgia

A theory that septic systems contribute to reservoir drawdown is flawed, according to industry leaders

Without last year's extreme drought, the plan proposed by the Georgia Water Council for the state's future water supplies would have been just another document that wouldn't gain much attention. The first draft, written primarily by the Georgia Department of Natural Resources, Environmental Protection Division, or EPD, was released in September 2007. Final revisions were to be completed on Dec. 21 for the 2008 legislative session beginning in January.

The document, however, contained statements labeling onsite systems as 100-percent consumptive water users, and that sewers are the preferred disposal option because they return treated wastewater directly to rivers and streams. If passed, the legislation would create a fast track for Georgia to sewer as much of the state as possible and eliminate onsite systems.

Pumper Interview

By **Scottie Dayton**

Mark Hooks, National Onsite Wastewater Recycling Association board member and regulatory consultant for Infiltrator Systems Inc., the Georgia Onsite Wastewater Association, and major industry manufacturers responded when Carol Couch, head of the Georgia EPD, engaged them for comment. Couch and staff dramatically altered the plan. It now recognizes that onsite systems are a permanent part of the state's wastewater treatment strategy, but retains the "consumptive water user" statement.

Pumper: How did the concept of onsite systems as 100-percent consumptive water users arise?

Hooks: Georgia has experienced a water shortage in some rivers and streams since 1992, but the drought focused the controversy mainly on the City of Atlanta and its water supply. Atlanta doesn't have a productive groundwater system, so nearly all of its water comes from surface reservoirs, which are managed by the U.S. Army Corps of Engineers. An agreement with the Corps allows Atlanta to draw water from the lake, but the city is withdrawing more than is stipulated.

The state argues that its treatment plants are returning water to rivers and streams, and that offsets the excess Atlanta withdraws from the reservoirs. City treatment plants can meter the return flow, but onsite systems have no meters. The Atlanta Regional Commission documented in a report that it asked the GDEQ for guidance on onsite system consumptive use. The commission was told that treated wastewater from onsite systems was considered 100-percent consumptive use.

We know that isn't the case. Water flows downhill, and wastewater is no different, but we have no scientific evidence to determine how fast it occurs. Infiltrator Systems Inc. asked Florida State University to do a literature review to locate such documentation. Researchers focused mainly on Georgia and found nothing. Most research focused on water quality rather than water quantity.

Pumper: How did what looks like a water conservation bill become one that discourages onsite systems?

Hooks: When severe drought hit before 2001, the legislature passed a law mandating the EPD to chair the Georgia Water Council and come up with a plan for the state's water quality and quantity. The absence of data on the return of water from onsite systems to rivers and streams led them to declare that septic systems are consumptive users of water. They assumed that onsite systems hold the water in the ground for decades.

Various industry people, including me, met with the EPD to voice our concerns. We pointed them to the U. S. Environmental Protection Agency Management Guidelines and third-party research. The revised plan recognizes that onsite systems are a viable part of the state's economy, do protect the public's health, and will continue to be around. It's more in line with national models.

Our only remaining objection is that the plan still describes onsite systems as consumptive water users. Our position is that we need research to determine how much and how quickly does water return to the rivers, and how much is lost through evaporation.

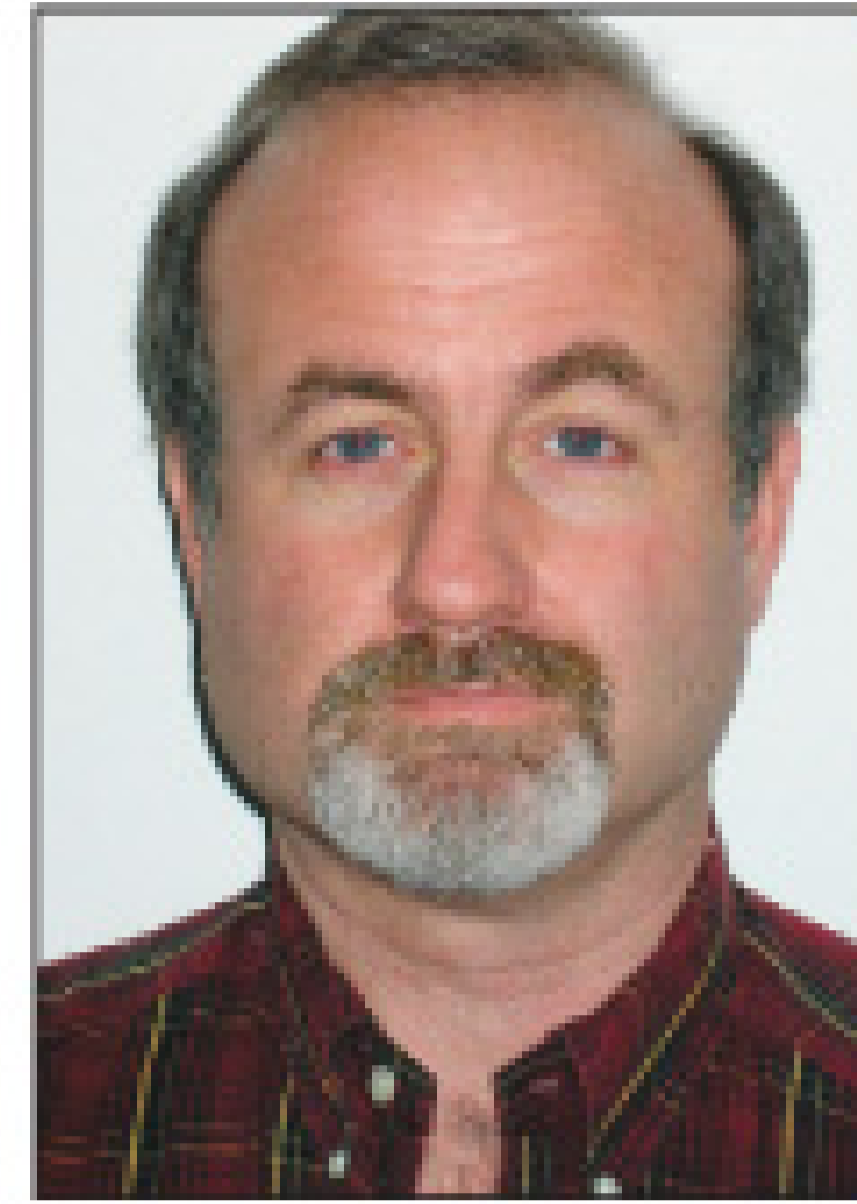

"MY FAVORITE ANALOGY IS COMPARING A SEPTIC TANK WITH A CAR ENGINE. YOU DON'T WAIT UNTIL THE ENGINE SEIZES UP TO CHANGE THE OIL. LIKewise, DON'T WAIT UNTIL THE DRAINFIELD FAILS TO PUMP OUT THE SEPTIC TANK."

Mark Hooks

Pumper: What evidence did out-of-state, third-party studies provide?

Hooks: One study, "Consumptive Loss from an Individual Sewage Disposal System in a Semi-Arid Mountain Environment," was published in the August 2007 newsletter of the Water Center of Colorado State University. It showed that in more arid environments, 85 percent of effluent water returns to the groundwater. (The paper is found at <http://cwri.colostate.edu/newsletters/2007/4.pdf>)

The Florida Department of Health also has researched wastewater issues. One study focused on whether more nitrogen should be removed through advanced treatment systems. Part of the answer lay in knowing how rapidly water moved from drainfields to underground aquifers. Since Florida shares a common aquifer with the southern part of Georgia, this study is germane to the Georgia issue.

Using two unique tracers, researchers calculated some drainfield flows moving at 285 feet a day, which compares with wastewater flows in sewers. (The FDoH reports are found at www.doh.state.fl.us/environment/ostds/research/researchreports.htm)

Todd Rasmussen, a professor of hydrology at the University of Georgia, was quoted in a *Gainesville (Ga.) Times* article that during droughts, properly maintained onsite systems ease water shortages by recharging streams and reservoirs. He visited rivers adjacent to decentralized subdivisions and sewered areas. The only rivers showing any flow were next to properties with onsite systems.

Pumper: Does water conservation in the home create a more concentrated product in the septic tank?

Hooks: Florida's DoH studied concentrations of wastewater as part of a high-strength waste study. Water conservation in the home doesn't change how much organic material enters the tank. Yes, it's more concentrated, but with less water discharging, the same size drainfield can handle it. From the research I've seen, drought doesn't make much difference in the biomat. The key element is maintaining the systems properly.

Simply put, drought is good for treatment. When water tables are low, the unsaturated flow beneath drainfields maximizes the removal of all bacteria and viruses. Soil isn't a friendly environment for germs.

Pumper: How do you see the future of onsite systems unfolding?

Hooks: Onsite systems are a viable part of every state's economy and a permanent part of our wastewater infrastructure. In Georgia alone, homeowners have spent something like \$3.5 billion dollars installing them. It's just silly to say that we're going to replace them with sewers. The cost effectiveness of sewers goes way down on half-acre lots and larger because municipalities must maintain many more feet of pipe per customer. That means higher rates.

Onsite systems will always be more cost effective on low-density development. According to national figures, the cost of a typical onsite system is between \$2,500 and \$7,500, and \$250 every three to five years to maintain. That compares with \$1,000 every year for sewer hookup and usage fees.

Pumper: What can pumpers do to help win the big pipe versus onsite battle?

Hooks: Educate the public to maintain their onsite systems. Educate their lawmakers about the problems septic tanks cause if they are not routinely pumped out. Make the point that onsite systems have a bad name because most people don't maintain them. When they are maintained, they last for decades.

Pumper: What is the best way to educate homeowners and legislators?

Hooks: Become an active member in your state onsite association and join NOWRA. NOWRA has a Memorandum of Understanding with numerous national organizations that are trying to spread the message. Talk to your newspaper.

My favorite analogy is comparing a septic tank with a car engine. You don't

wait until the engine seizes up to change the oil. Likewise, don't wait until the drainfield fails to pump out the septic tank.

Pumpers should sell a service maintenance agreement whenever they pump out a tank or respond to a failed system. To combat the "you're just trying to line your pocket" argument, point to what the nation's experts in environmental and public health protection have to say. My favorite link to share with pumpers is the U.S. Environmental Protection Agency Web site promoting proper system management (<http://cfpub.epa.gov/owm/septic/index.cfm>).

Mark Hooks may be reached at 888/261-8265. ■

FINANCING

FOR ALL YOUR NEW & USED EQUIPMENT

GIVE US A CALL TODAY!
866-769-2345

31 YEARS OF EXPERIENCE WORKING FOR YOU!



- Application Only to \$250,000.00
- Simple Approval Process
- Lease or Loan Options
- Aggressive on Used Equipment
- Start-up Programs
- Flexible Financing Available

CAPITAL PARTNERS

101 N. Main Ave. Suite 215
Sioux Falls, SD 57104
www.yourcapitalpartner.com
866-769-2345

YOUR ONE STOP FINANCING PARTNER

Competitive Pricing, Simple Processing, Honest Answers



Amthor Matador

We're proud to be an official distributor of



aluminum, steel and stainless steel vacuum tanks.



Call TODAY for immediate delivery.

(888) 204-7872
www.stuarttank.com
940 East Geneva Street PO Box 558
Elkhorn, WI 53121

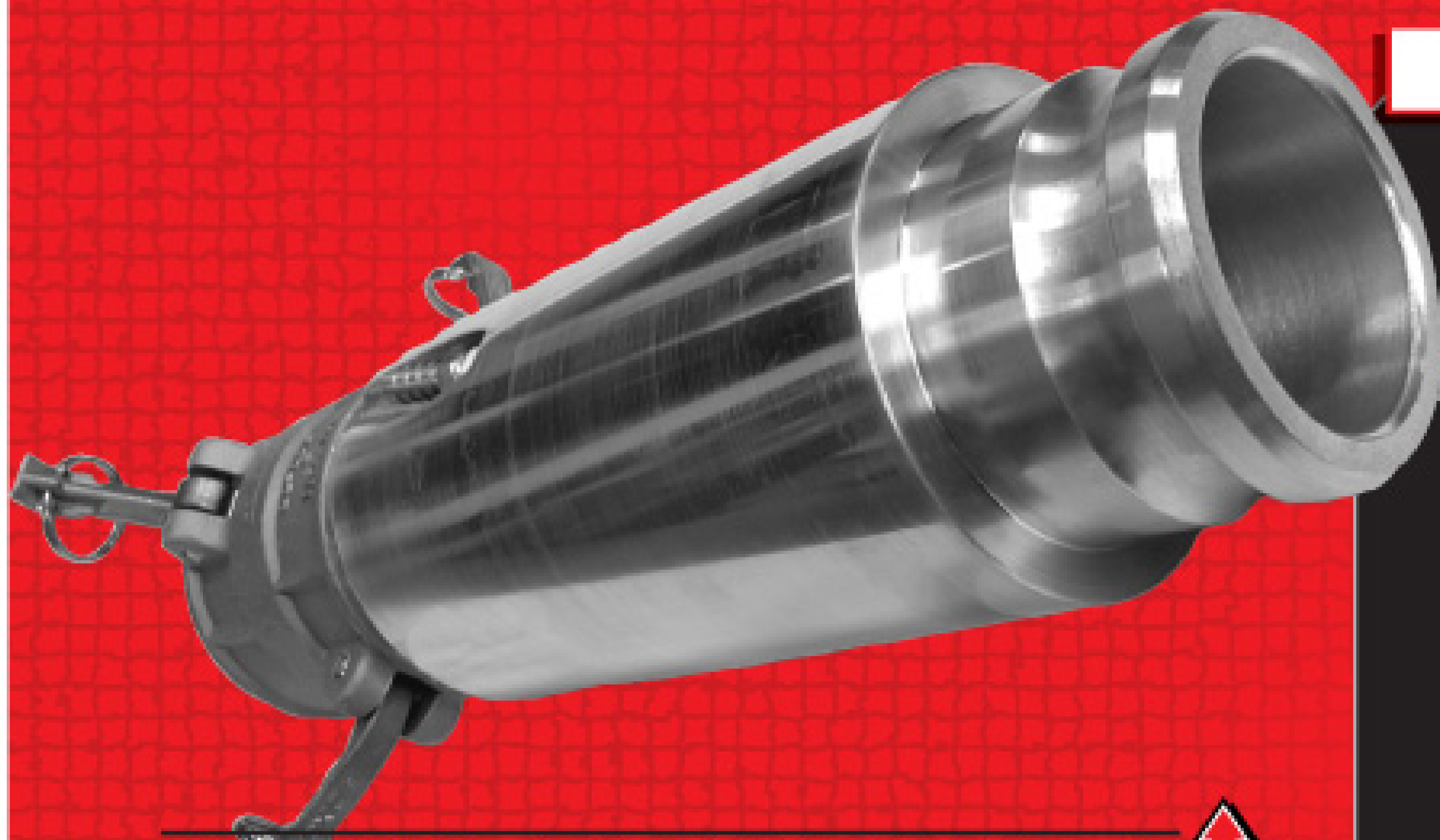

POWER BOOSTER



Thank you for visiting us in Louisville

Patented Technology for Pumping

PL Pressure Lift Corp

- REDUCE PUMPING TIME
- INCREASE VERTICAL LIFT CAPABILITY
- INCREASE VACUUM PUMP PERFORMANCE
- DECREASE WEAR ON PUMP & EQUIPMENT

CALL TODAY FOR A FREE DEMO DVD

Pump Deeper – Pump Quicker

972.355.0550

www.pressurelift.com

Introducing... ^{Now Available!} 18"

the Most Durable & Economical Septic Lid in the Market Today.

- Durable Roto-Molded Construction WILL NOT Crack Like Concrete!
- Lightweight Polymer is Easier to Handle & Transport
- Corrosion Resistant Stainless Steel Screws Included
- For use with Standard 18" & 24" I.D. Corrugated Pipe
- Easy Slide-in Installation
- Optional Sand Filled

Cost Effective
6 Pack
Shipping



Give Us a Call for More Information

800.868.0973

Don't Waste Money On Expensive Riser Systems!

"DON'T BE EMBARRASSED AGAIN!" HOW AWFUL...

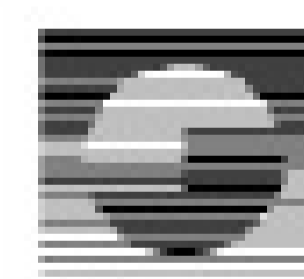

800-622-8768
sweetair.com

SWEET SEPTIC SYSTEMS, INC.
5701 Mother Lode Drive • Placerville, CA 95667
Fax: 530-622-1087

SWEET AIR™ FILTERING DEVICE

PAT PENDING

HOW WONDERFUL...

UPC Approved





Aluminum Slide-In Vacuum Units Portable Restroom Service

300 Gallon Waste / 135 Gallon Fresh
Other sizes and options available

NEW! Factory Assembled & **IN STOCK!**



Masport H1V or Conde Super 6 vacuum pump w/ 4-way valve

Electric Start HP Honda Engine

Hose holder with 50' of garden hose and nozzle

ShurFlo 2088 3.5 G.P.M. 12 volt water pump. Up to 45 P.S.I. or equal

3" valve on discharge with adapter and dust cap



Water compartment with 2" fill opening

Hose holster

1/2" drain valve and 1/2" sight tube

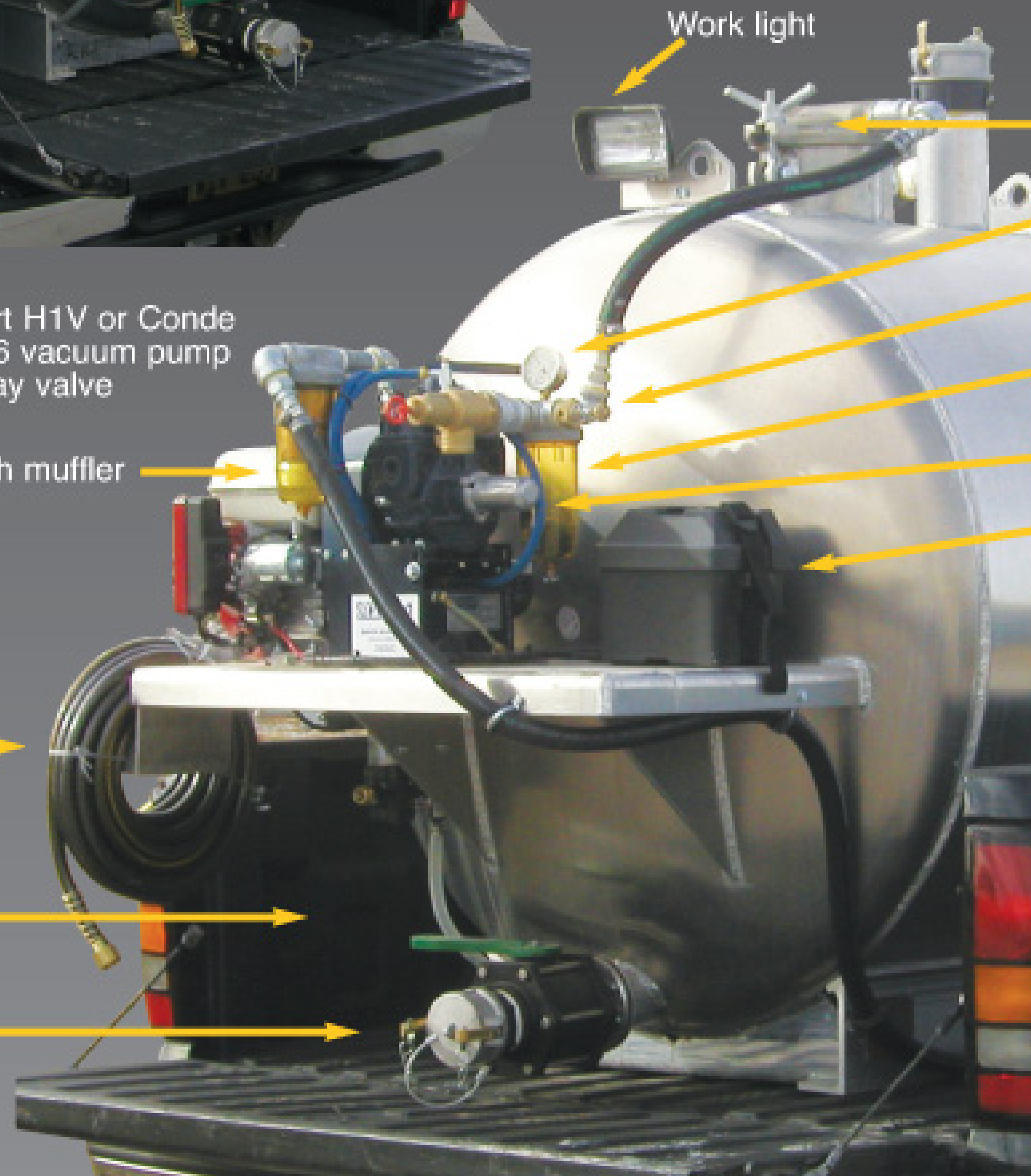

Work light

NVE 2" Aluminum Primary

30/30 gauge

Vacuum relief valve

Secondary moisture trap

Pressure relief valve

12 Volt battery w/ PVC battery box

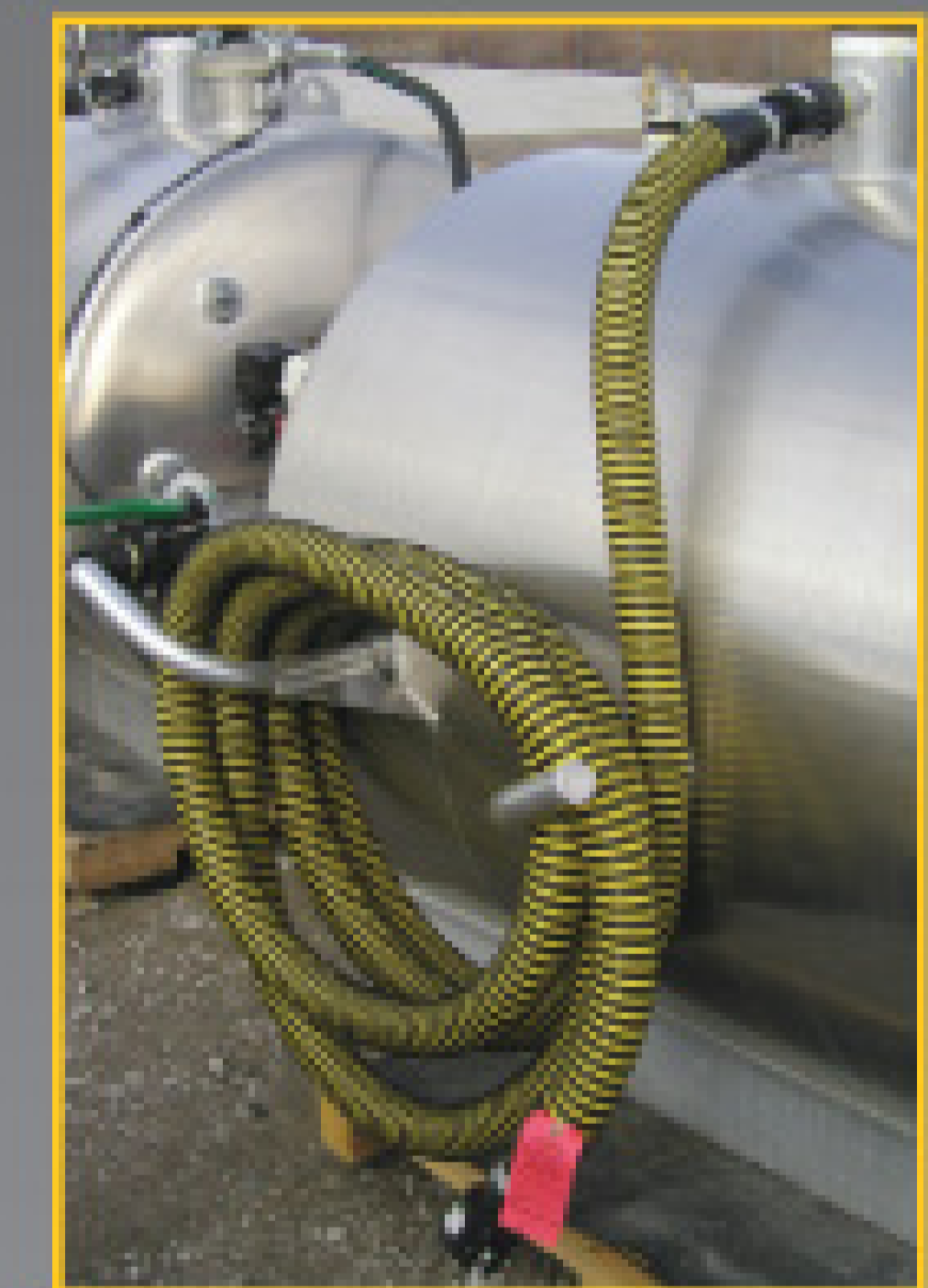

30' of 2" tiger tail hose w/ valve & stinger

Completely self-contained & work ready

\$8,500 M.S.R.P. F.O.B. Kansas City, KS

OPTIONS: Inlet hose on both sides: Add \$650 for second system that includes: 30' x 2" tiger tail hose, holder for stinger, 2nd set hose hooks and dual inlet valve. Hose reel complete: Add \$250

See your nearest **progress tank** distributor for additional information

www.progress-tank.com

SUCCESS COMES IN



TUFWAY



TAURUS

NO MATTER WHAT YOUR
OPERATION REQUIRES, WE
HAVE YOUR SUCCESS IN MIND.

Whether your business caters to construction, recreation, or special events, the Satellite/Synergy family of portable restrooms has you covered. From the dependable and economical Tufway to the most sophisticated flushing restroom in the industry, the High Tech II Deluxe Flush, we've taken the guesswork out of success. We can help you choose the right solution for the job – for a single unit or an entire fleet.

► Contact your area manager to discover what we have in mind for your success.

ALL SHAPES & SIZES.



MAXIM 3000



HIGH TECH II

CONTACT YOUR AREA MANAGER AT:

1 (800) 328-3332

VISIT US ON THE WEB AT:

SatelliteIndustries.com | PortableToilet.net



SYNERGY WORLD



PARTNERSHIPS MADE FOR SUCCESS



TIGERFLEX™



Tiger™ Green/Tiger™ Yellow/Tiger™ - SD

- Superior EPDM compounds - longer life; more durable; superior chemical resistance.
- Superior Flexibility - 22% more flexible! Easier to handle off trucks, especially in cold weather!
- UV and weather resistant exterior.
- Specially designed abrasion-resistant helix - slides over and around objects; easier to handle and work with.
- Tiger™-SD - reinforced for both suction & pressure discharge applications.

Applications:

- Septic handling
- Liquid and dry chemical & fertilizers
- Sewer cleaning water jetting leader hose
- Construction



Kuriyama of America, Inc. 360 E State Parkway | Schaumburg, IL 60173
847.755.0360 | fax: 847.885.0996 | email: sales@kuriyama.com | www.kuriyama.com



New
Tiger™ Yellow

Tiger™ Green

Nothing Else is
TIGER™ GREEN
Ask For It By Name!

WANT A TRUCK THAT REALLY SUCKS?

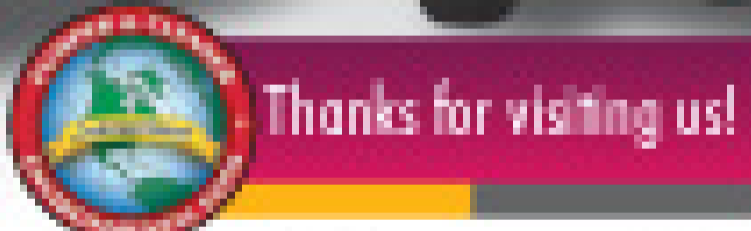

Vacuum Trucks from Rocket Supply

The Amthor Matador Flat Vac

The Amthor Matador Flat Vac offers an exclusive improved tank design available in 5/16" aluminum, 1/4" steel and 1/4" stainless steel with capacities from 500 to 2000 gallons with full internal baffles. This unique body is used to service portable toilets and can carry 8 to 12 at one time, making it a very efficient vehicle. Features a rounded floor that allows for easy product drainage.

The Amthor Matador

The Amthor Matador offers an exclusive improved tank design available in 5/16" aluminum, 1/4" steel and 1/4" stainless steel with capacities from 500 to 7000 gallons. With full internal baffling and a heavier side shell than the competition, it allows for the absence of external rings, which provides a smoother looking tank when adding your brand or logo to it. Dumping options are also available.

For Excellent Price and Fast Delivery!



Contact Us for More Details



Roberts, Illinois • 800-252-6871 • www.rocketupply.com

Terms – No Problem

*We finance all types of equipment.
We offer a variety of terms, all designed
to meet your cash flow and/or tax needs.*

Community Leasing Associates, LLC

1-877-459-5770

www.clalease.com



Good People - Great Rates

THE BEST!

Art Blaster Biodegradable Graffiti Remover

ART BLASTER ---

Takes off paint, pen, crayon, tar, soap scum, grease, calcium buildup and many more substances from Portable Toilets.

ART BLASTER ---

Leaves behind a *protective sheen* that prevents new offensive graffiti—even pencil wipes off!

ART BLASTER ---

Environmentally and user friendly. Created to work hard so you don't have to.



Call our customer service team for more details.

1-800-345-3303
www.jjchem.com



Thanks for visiting us!



Extreme Makeover IHI Style

- 12 Models - 2 Styles
- Zero Tail Swing & Conventional Style
- Operating Weights 2,060 to 18,100 lbs.
- Digging Depths from 5'2" to 15'1"
- Control Pattern Change Valve Standard
- Multi-Function Hydraulic System



400 Production Court, Elizabethtown, KY 42701

800-538-1447

www.ihcompactexcavator.com



We Build Trucks That Suck!

VSI Vacuum Sales Inc.
51 Stone Rd. | Lindenwold, NJ 08021

888-VAC-UNIT | 888-822-8648 | Fax: 856-627-3044
E-mail: vsisales@aol.com | www.VacuumSalesInc.com

NEW EQUIPMENT CUSTOM BUILT TO YOUR SPECIFICATIONS



(8734V) 1998 International 4700 with a 1,500 U.S. gallon, 2-compartment (1100/400 split), Carbon Steel; portable toilet service unit.



(2104V) 1999 Freightliner FL60 with a 1,000 U.S. gallon waste, 250 U.S. gallon water; 250 U.S. gallon mix; 3-compartment, Stainless Steel vacuum tank, with a NVE 184 vacuum pump and washdown system.



(13294) 2008 Sterling LT9500 triaxle with a new Presvac, Powervac 3800, 3,250 gallon (US), DOT, wet/dry industrial, vacuum tank loader



(13289) New Presvac 2,000 U.S. gallon 2-compartment (1500/500), Aluminum vacuum tank, with a Moro M3 vacuum-pressure pump installed on a 2007 Chevy C7500 Cab and Chassis.



(13273A & B) 2-2007 New Acro Trailers New Acro 7,000 U.S. Gallons Aluminum vacuum pressure tanks



(13281B) 2007 Sterling LT9500 new Presvac, Powervac 3800, 3,250 gallon DOT, wet/dry industrial, vacuum tank loader.



(13329V) 2001 Freightliner C120 can and chassis with a new Presvac 3,200 gallon DOT 407/412 Certified Vacuum - pressure tank.



(13317) New PipeHunter Model 38T44 Jetting unit Trailer mounted unit, w/ 335 Poly water tank 4,000 psi @ 25 gpm, 600 ft of hose and attachments.



(13297A) 2007 Peterbilt 340 with a Presvac 3,600 gallons (US), aluminum vacuum tank unit.



(5008V) 1990 Presvac 5,000 stainless steel D.O.T. with pump engine.



**Appearance
Performance
Quality
Since 1939**

Conde PowerPaks

More Power To You

**Conde gas powered vacuum units
are compact, powerful, and
ready to install for instant vacuum**

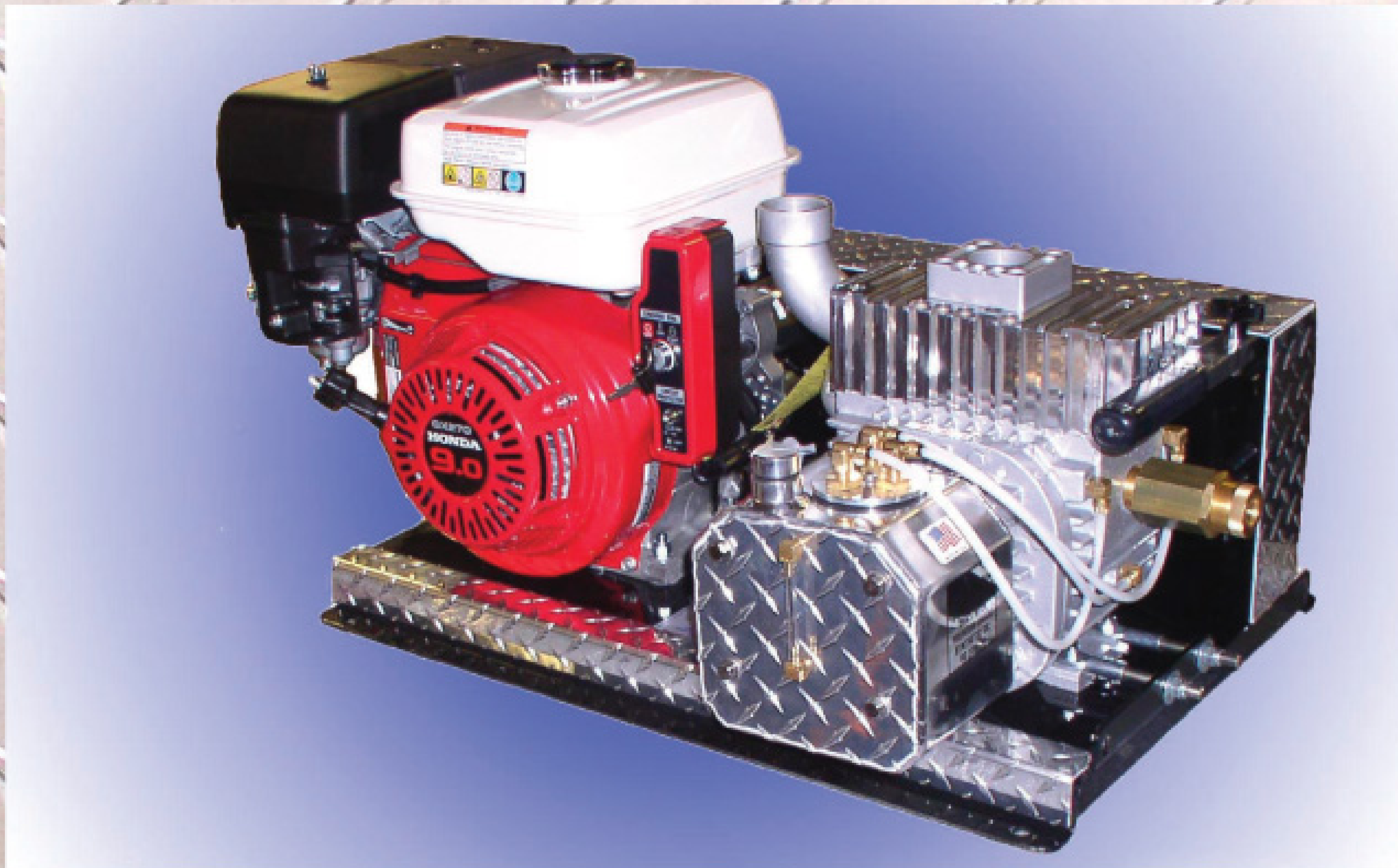

**Thank you for visiting
us in Louisville**

Westmoor Ltd.

P.O. Box 99
Sherrill, New York 13461

Call Toll Free 1-800-367-0972

On The Web At: www.westmoorltd.com E-mail: pumps@westmoorltd.com

FOOT SOLDIERS WANTED



Technician Donnie Mundis of Taylor's Septic Service & Portable Toilets connects a hose to a septage storage tank at the company's yard. Below, Greg Rogers and Mundis work with a hose. (Photos by Richard Ryman)



Virginia company looks for hardworking employees to aid in expansion effort

By Richard Ryman

Business is good for John and Penny Taylor. They are a septic pumping company in central Virginia, and their customer base is expanding. If only they could say the same for their work force.

John Taylor's greeting to a visiting writer was immediate.

"You come to work?"

He wasn't entirely joking.

"Getting workers is the biggest problem we have. It's not just us. The labor skill force is terrible. All these kids coming out of high school want big checks," he says.

The day of his interview, in fact, one of Taylor's employees didn't show up for work, having told co-workers he was quitting. Taylor was disappointed because he was "an excellent employee."

EVERYONE PITCHES IN

Taylor says he wouldn't hesitate to hire some of the many Mexican immigrants to the area because they are willing to work, but they don't have the necessary driver's licenses and he'd have to provide them a place to live.

"The septic pumping never slows down, except a week and a half before school starts and Thanksgiving to Christmas," he says.

The Taylors run operations from a small office in the basement of their rural Appomattox County home. From there Penny Taylor handles the business end of the operation, talking to customers, quoting prices, billing and scheduling routes.

They are about three miles east of Appomattox Court House National Historical Park, the site of Gen. Robert E. Lee's surrender to U.S. Grant at the end of the Civil War.

One of their four daughters lives in a nearby house — they have two sons as well — and a 2-year-old granddaughter is a regular visitor.

The Taylors say they do what they can to attract and keep good employees. Workers are paid a salary, rather

Profile

Taylor's Septic Service & Portable Toilets Inc.

Appomattox, Va.

Owners: John and Penny Taylor

Years in business: 12

Employees: 6

Services: Septic pumping, portable sanitation, installation, maintenance and repair of septic systems, video inspections, excavation

Web site: www.taylorsseptic.com





It's important for Taylor's Septic Service & Portable Toilets Inc. to maintain an updated fleet, shown in the company yard, as it looks to expand its service territory.

"MOST BUSINESS IS REPEAT BUSINESS. IT'S NOT ALL ABOUT PRICE. IT'S ABOUT THE QUALITY AND THE SERVICE THEY GET."

John Taylor

than hourly, a recommendation of state employment officials, Taylor says. He says employees average 50-55 hours a week, and they are paid overtime for weekends or special events.

"In winter, part-time guys only work four days and they get the same pay. These guys have to feed their families five days a week," he says. "The pumpers are on salary, but they don't work the same hours the portable toilet guys do."

Taylor uses a time clock to track hours so they can be sure of how much time it takes to do the work.

They've set up a 401(k) for employees to which they also contribute, and they'll pay half of health insurance premiums after one year's employment.

LOOKED FOR BETTER SERVICE

The Taylors started pumping septic tanks for their own benefit. They were not happy with the prices they were getting for pumping at the rental property they owned, so they bought their own vacuum truck.

"We didn't do this for the general public. People just kept calling. I got off work and was pumping septic tanks," Taylor says.

Taylor worked for a Pepsi distributor for more than a decade before taking up the septic and portable restroom business full time in 1996. His experience working for Pepsi provided marketing insights. Properly priced services, for example, mean continued business.

The Taylor team includes (from left) John and Penny Taylor, Mark Morrison, Adam Taylor, Donnie Mundis, Carrie Taylor and Greg Rogers. Adam and Carrie are John and Penny's children, who both help out on the portable sanitation side of the business.



"Most business is repeat business," he says. "It's not all about price. It's about the quality and the service they get."

Technician Donnie Mundis (left) and John Taylor repair a small pump on a portable sanitation vehicle. Everyone pitches in on maintenance to keep up with a growing workload.

The same thinking applies to onsite system installation, which is a large part of the company's business, he says. The service area is awash with septic systems. There are some municipal systems in the smaller towns, but subdivisions are booming and new septic systems are needed. Penny Taylor says 10 new subdivisions were built around Appomattox alone. The company installed two systems a week for much of the 2007 busy season.

EDUCATING CONSUMERS

John Taylor says they do their best to educate residents about septic system use and care.

"We see these older people who don't understand the concept of a septic system. You have to stand right over the septic system and show them, 'Here's your sludge level.' It gets deeper and deeper until it's in your field. A lot of time we can clean the field out. We can get it, but you lose part of that field," he says.

Taylor developed his own system for cleaning fields using his jetter with the pump truck, combining a water pressure and vacuum technique.

"This works best on PVC or plastic pipe," he says. "It's not recommended for alternative systems. I've only had one system that it didn't work on, but the system was 50 years old and it was concrete drain tile."



"IN WINTER, PART-TIME GUYS ONLY WORK FOUR DAYS AND THEY GET THE SAME PAY. THESE GUYS HAVE TO FEED THEIR FAMILIES FIVE DAYS A WEEK. THE PUMPERS ARE ON SALARY, BUT THEY DON'T WORK THE SAME HOURS THE PORTABLE TOILET GUYS DO."

John Taylor



Above, John and Penny Taylor and their granddaughter Madisyn check out the portable restroom inventory. At right, the Taylors' daughter, Carrie, services a restroom. The Taylors are thankful for Carrie, a college student who helps out during the busy season.



both septic and portable sanitation business. Over the summer, they provided 30 restrooms to Liberty University in Lynchburg, and local schools are pumped regularly.

"We have school contracts pumping 35,000 gallons at a time. We have routine schedules with municipalities. We clean lift stations quarterly," he says.

The company's septic fleet consists of a 1978 Chevrolet C60 with a 1,500-gallon steel tank, a 1980 GMC Brigadier with a 3,500-gallon aluminum tank built by Longhorn Tank & Trailer, a 1997

Chevrolet C7500 with 2,500-gallon steel tank, and a 1999 International with a 4,500-gallon aluminum tank built by Amthor International.

Portable sanitation equipment includes a 1993 GMC pickup with slide-in 200-gallon waste/100-gallon freshwater aluminum tank, built by Imperial Industries Inc., a 2003 GMC C4500 with 300-gallon waste/150-gallon freshwater slide-in unit built by Pik Rite Inc., a 2004 GMC C4500 with 500-gallon waste/200-gallon freshwater slide-in unit built by Lane's Vacuum Tank, and a 2005 Ford F-750 with 2,200-gallon aluminum tank built by Lely Manufacturing.

Utility vehicles include a 1993 Ford F-350 crew cab utility truck, a 2004 Ford F-350 crew cab and a 2007 Chevrolet four-wheel-drive pickup truck with lift gate. They also have two

The folks moving from the cities to the rural subdivisions are as uninformed, he says.

"You get the repeat customers who live and learn. They go to their basement and say, 'What is that smell?' We see quite a bit of that," he says.

Taylor recommends Scott or Angel Soft bathroom tissue. He said another popular brand "is like cement. You have to add 1,000 gallons of water to break it up."

Penny Taylor says that with uneducated homeowners, everything goes into the septic tank, including grease.

"I explain to people it's like cholesterol. It's hardening up," she says.

WEB PRESENCE

Penny Taylor says past attempts to remind customers when cleanings were due had poor results. She says the usual response was "Well, I think I'll wait."

Now, they hand out pamphlets to customers and they have an extensive Web site that includes a frequently asked questions, or FAQ page and chart for determining proper septic tank capacity. There are pages to request free quotes online, photos of portable restrooms, company history, a code of ethics and testimonials.

In 2002, the Taylors added portable restrooms, which now make up about 40 percent of their business. They have 500 units. Construction sites, festivals and ballparks are the predominant customers.

"About one-third are on ballparks from March to fall. There is a festival every weekend. We have two full-time guys; all they do is clean toilets, five days a week. When our daughter is home from college, that's all she does all summer," Taylor says.

Institutions provide work for



At left, Donnie Mundis navigates a 2004 Ford F-350 crew cab service vehicle that carries all necessary tools for onsite system repairs. Above, a well-worn 1940s International Harvester tractor is still used for small onsite system repair jobs.



John and Penny Taylor, with granddaughter Madisyn, show off their 1999 International vacuum truck with 4,500-gallon aluminum tank from Amthor International.



A 1997 Chevrolet C7500 service truck with a 2,500-gallon steel tank is a staple among three pumper trucks used mainly for residential septic service.

equipment trailers, a 1984 Mack R686 dump truck, a 580L John Deere backhoe with extended bucket and eight-, 12- and 20-unit portable restroom carriers.

The portable restroom inventory includes four trailers with attached restrooms, 20 handicap-accessible units, 381 standard units, eight freestanding units with hand-wash stations and 10 holding tanks. Manufacturers include Olympia Fiberglass Industries Inc. and Satellite Industries.

Routine truck and equipment maintenance is done at the company shop and more extensive work is farmed out.

DISPOSAL ISSUES

To limit unnecessary trips to the disposal facility, Taylor has installed four 1,500-gallon temporary storage tanks underground on his property.

Taylor says he spends \$100,000 a year in disposal fees. He says county and local regulators will not allow

them to use a dewatering system or do field application. He says 99 percent of his waste goes to Lynchburg, and when they do work for local municipal plants, those plants accept that waste.

Taylor disposed of 951,000 gallons at the Lynchburg facility during the past year, which was 17.2 percent of all deliveries, the most of 18 haulers using the facility, according to Lynchburg Wastewater Treatment Plant records.

"We are better off than a lot of places. Lynchburg takes restaurant grease from within their area. We take all kinds of things to them," he says.

Greg Rogers, his septic installer, handles installation training, and Taylor the training for pumping. He is also a confined-space certified instructor.

Taylor says his crew works to live up to the company's well-established reputation.

"I tell employees, my name's on that truck or my name's on that (company T-shirt)," he says. "Everybody knows me. I am a working owner and I am involved in all my septic pumping, repairing, installation and portable toilet services." ■

Taylor's Septic turns to creative financing

When it came time for John and Penny Taylor to expand their business, they found limited financial options. Though the septic business was well established, the Taylors found lenders were less than helpful when they wanted to expand the portable sanitation side of the business.

Penny Taylor says their initial 50 units were continually rented and had new markets — such as construction sites and parks — they needed to get into. They wanted to buy more restrooms and more trucks.

The bank said it was too much of a risk.

Their solution was one not favored by business schools or credit counselors — or even Penny Taylor, for that matter — but they were confident enough of their prospects to risk it. They used credit cards.

The Taylors charged purchases to credit cards with zero-interest periods and transferred the balances to new cards before interest began to accrue. Taylor said she tried to keep payments ahead by three to six months.

By managing cash flow with great care and making payments on time, they were able to expand the business, and with less expense than with a traditional loan. Penny Taylor estimates they saved \$30,000 in interest along the way.

"I don't recommend this method. My daddy always told me that your credit is something that you never want to mess up. It's like your name. People know you by it, and if you are creditable, then you are worthy," Penny Taylor says. "I did it because I believe in our company and I am very disciplined when it comes to money and paying for things. I knew what had to be done."



Penny Taylor is adept at using credit card borrowing to finance portable sanitation equipment. Careful cash flow management has saved the company \$30,000 in interest.

MORE INFO:

Amthor International
434/656-6233
www.amthorinternational.com

Imperial Industries Inc.
800/558-2945
www.imperialind.com

Lane's Vacuum Tank Inc.
800/592-3308

Lely Manufacturing Inc.
800/334-2763
www.lelyus.com

Longhorn Tank & Trailer Inc.
800/422-9840
www.longhorntanktrailer.com

Olympia Fiberglass Industries
800/544-3878

Pik Rite Inc.
570/523-8174
www.pikrite.com

Satellite Industries Inc.
800/883-1123
www.satelliteindustries.com



CAPITAL RUBBER CORP

Get Connected.



POWER BOOSTER

- INCREASES VERTICAL LIFT
- REDUCES PUMPING TIME
- REDUCES PUMP WEAR

CALL TODAY
FOR OUR NEW CATALOG

(800) 258-3000

**YOUR SOURCE
FOR ASSEMBLIES & MORE!**



**WEATHERFLEX
SUCTION HOSE SPECIAL!**

3" X 25 FT \$99

3" X 33 FT \$125

COUPLINGS INCLUDED

www.capitalrubbercorp.com

CADMAN / ALBERS

For Emergency or Temporary Storage of Liquids



- Safe, affordable enclosed storage.

- Up to 1.3 million U.S. gallons of capacity.

- Various agitator options.

- Neighbor friendly odor control.

- Blends in with the surroundings.



**We also offer fully portable, transportable systems.
Your containment solution is only a phone call away.**



38 Main St. • Courtland, Ontario, Canada
1-866-422-3626
www.cadmanpower.com



Tanks For Your Business

Mid-State Tank manufactures stainless steel and aluminum tanks and has become a well-known and respected supplier for the agricultural, aviation, industrial and fire services, as well as pressure/vacuum tanks.

Mid-State Tank holds an ASME stamp and is D.O.T. approved.



Mid-State Tank Co., Inc.

PO Box 317 • Sullivan, IL 61951
(800) 722-8384 • Fax: (217) 728-8384
www.midstatetank.com





GET YOUR POT OF SAVINGS AT LELY!



THANKS TO PARKER LANE DRILLING



THANKS TO HOGAN'S TRUCKS UNLIMITED



**THE ORIGINAL GEM JET
IS STILL THE BEST.
2000 PSI @ 15 GMP**



**300 + 100 GALLON READY TO GO UNIT
THAT WILL FIT IN THE
BACK OF YOUR PICK-UP**

**Financing
Available**



THANKS BROCKWELL SEPTIC



**IN STOCK FOR IMMEDIATE DELIVERY -
1100 + 450 PORTABLE TOILET TANK ON A KW
CHASSIS. CALL FOR DETAILS.**

**WE HAVE STEEL TANKS IN STOCK READY
TO BE MOUNTED ON YOUR TRUCK**

LELY MANUFACTURING

P.O. Box 789 • Wilson, NC 27893
252-291-7050 • FAX: 252-237-7726
E-mail: sales@lelyus.com

800-334-2763

John Minnis, Sales Representative • 540-547-2463

Charlie Gilantzis, Sales Representative • 252-360-6331

www.lelyus.com



**SERVING THE
LIQUID WASTE INDUSTRY
FOR OVER 50 YEARS**

LELY WASTE SOLUTIONS

P.O. Box 1026 • Temple, TX 76503
254-938-2564 • FAX: 254-938-7204

800-367-5359

Bruce Curry • Earl Ballard
E-mail: bcurry@lelywaste.com

www.lelywaste.com

10280 Brecksville Road Brecksville, Ohio 44141



R.A. ROSS N.E., INC.

INDUSTRIAL & TRUCKING BLOWERS • VACUUM PUMPS • SALES, SERVICE, & INSTALLATION



We have a **FULL SERVICE REPAIR SHOP** capable of servicing and repairing a wide variety of different makes and models of blowers and vacuum pumps from all your top manufacturers including
**Tuthill/MD • Drum • Gardner Denver • Cycloblower • Duroflow • Sutorbilt • Roots • Hibon
 Fruitland • Moro • Masport • Wittig • NVE Challenger • Jurop • Battioni • Presvac
 Blackmer • Roper • Ranger • Viking**



NVE FRUITLAND CHELSEA
A DIVISION OF Parker

Vacuum Pumps • Components • PTO's • Hydraulics • Valves • Manways • Gear Boxes • Mufflers • Silencers • Gauges • Camlocks • Hose

TOLL FREE 1.800.678.4581 PHONE 440.546.1190 FAX 440.546.1188 EMAIL RAROSSNE@RAROSSNE.COM WEBSITE WWW.RAROSSNE.COM

Toll Free 888-207-2074 Fax (479) 770-6089

WILCOX TRUCK SALES, INC.



Lowell, Arkansas ... ESTABLISHED 1978

I-540 Exit #78 & Hwy 71B

2 hours East of Tulsa or 1.5 hours South of Joplin

www.wilcoxtrucksales.com

1999 Mack CH613

E7 Mack, 380 HP, 9 Speed, New 3360 Gallon Vacuum Tank, New Jurop R260 Pump, Custom Paint, 205" WB, One Owner, Fleet Maintained, AC, PS, Cruise, Ready to Make You Money



1994 Freightliner FLD120

3406E Caterpillar, 355 HP, 9 Speed, 4 Bag Air Ride Suspension, 3.91 Ratio, 219" WB, 3000 Gallon Vacuum Tank, 8) Matched Virgin Drivers.



LEASING SOLUTIONS



If you have special or unique needs, for straight answers and a quick response, call Jim Thomas.

Conserve your working capital. Keep existing credit lines intact, and enjoy the security of knowing financing is there when you need it. We offer loan and leasing plans tailored to individual needs.

- Portable Toilets
- Sewer Equipment
- Pumper Trucks
- TV Inspection
- Water Jetters
- New and Used Equipment
- Vacuum Trucks

- Programs offer longer terms for older equipment.
- We do start ups.
- 90 Day Delayed Billing.
- Seasonal Payment Programs Available

Get Pre-Approved for the Pumper & Cleaner Environmental Expo

Prompt, no nonsense financing designed to meet individual requirements. Payment plans that are generally lower than other finance plans. With years of experience, we understand the competitive nature of your business.

We're prepared to act quickly and decisively!

Toll-Free 877-333-4539 • www.keycommercial.com



Black Tie Manufacturing Now Offers 8' Restroom Trailers Starting at \$13,900!

Unlike our competitors, Black Tie standard features include:

- Stair System
- AC/Heat Strip
- Waste Tank
- Hot Water Tank

We CUSTOMIZE and offer attractive Financing Programs.

WHEN YOU BUY a trailer from Black Tie, you become a rental resource. We don't give you leads, we give you actual **Rental Opportunities**.



Sample floor plans

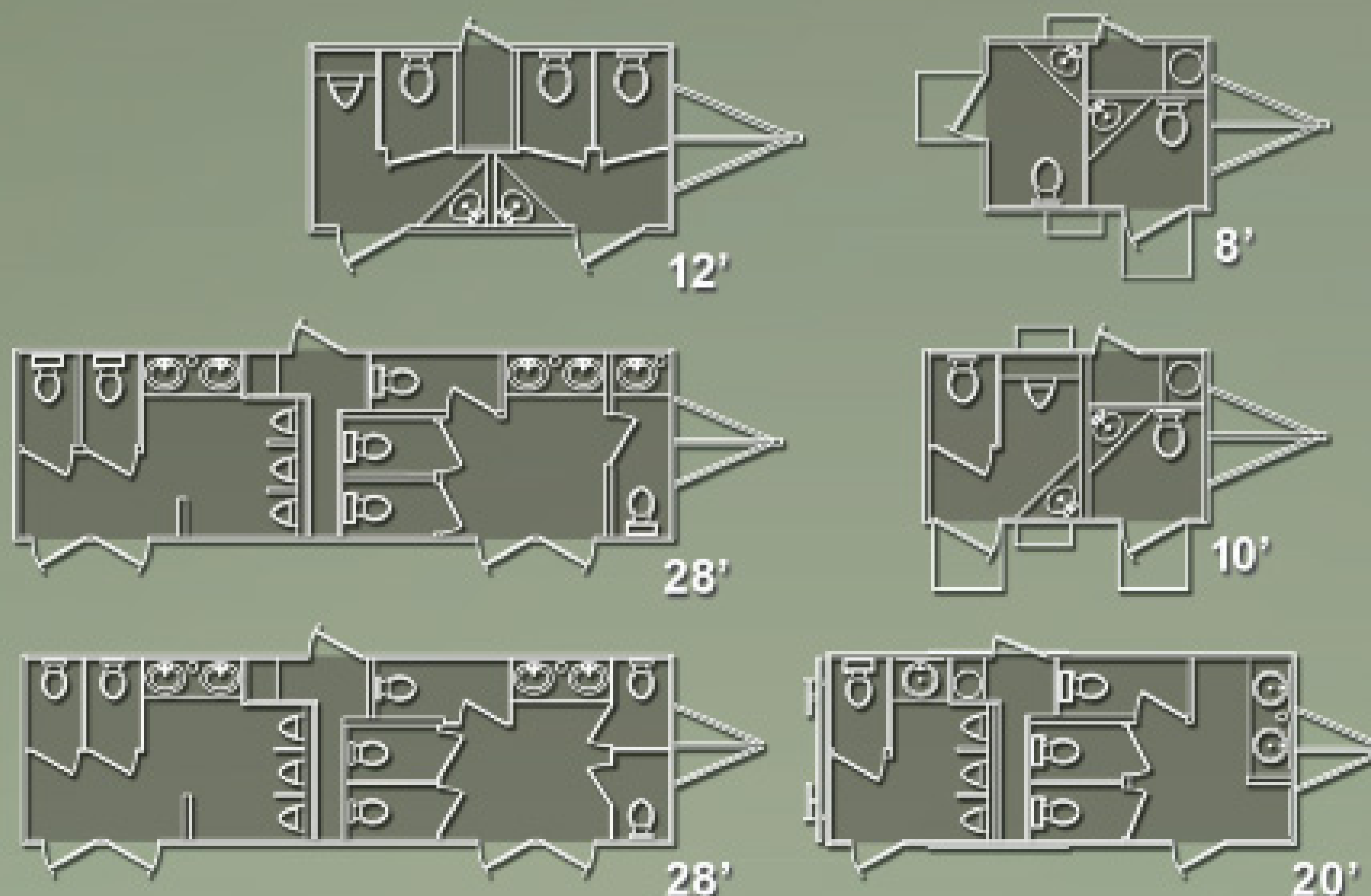

© 2008 BLACK TIE MANUFACTURING, INC.

Call **877-253-3533**

BLACKTIEMANUFACTURING.com/diamond
show@blacktiemanufacturing.com



Quality People Doing Quality Work

Industrial Vacuum Units

DOT Code & Non Code Vacuum Trailers



Vacuum Septic Units

Aluminum or Steel Tanks in a Variety of Capacities



Portable Restroom Service Units

Thank you Shawn M Petro Inc. from Gulfport, MS for purchasing a 950 Gal Restroom Service Unit mounted on a 2007 Ford.



Mini Vac Trailers

DOT Code & Non Code



Slide-In Units

IN STOCK - Slide-In Portable Restroom Units - Call for Details Industrial Skid-Mounted Units Also Available



Marsh INDUSTRIAL

P.O. Box 1107 - 135 E Mile Road - Kalkaska, MI 49646
p: 231.258.4870 - f: 231.258.2019 - sales@marshind.com

800.952.1537 - WWW.MARSHIND.COM

 Thank you for visiting us in Louisville

Kanaflex® 220RS Rubber All-Weather Suction Hose
SUPER FLEXIBLE IN COLD WEATHER

Call for Low Prices on 100' Lengths & Coupled Hose Assemblies

A revolutionary new method of manufacturing rubber suction and discharge hose has drastically reduced costs to hose users. The new process, ten years in development, utilizes **Kanaflex SBR TYPE "T" POLYMER** to give the lightweight, rubber hose outstanding flexibility and long life.

New **Series 220** rubber suction and discharge hose has excellent dimensional stability and is easy to couple. Manufactured in six sizes from 1-1/2" through 6", the hose is available in 100' lengths. I.D. and O.D. are smooth. **Temperature range is -40° F to 160° F** - ideal for industry and construction job site use.

Distributors of: **Dunlop • Goodyear • Kanaflex • Plastiflex Hi-Vac & Other Hose • P-T & Evertite Quickcouplers Dixon & Le-Hi Couplings • Hose Clamps • Banding Equip.**



SAVINGS UP TO **50%** FOR SUCTION & DISCHARGE HOSE USERS!

MRP

Toll-Free 1.800.325.3730

Milwaukee Rubber Products, Inc.

www.milwaukeeerubber.com

FAX: 262.781.1742

MAILING ADDRESS: P.O. Box 451 . Butler, WI 53007

WAREHOUSE: N52 W13319 Falls Creek Ct. . Menomonee Falls, WI 53051



Wolf Creek Co.

Original Bauer

Portable Piping

Bauer Fittings

Polybarb™ Pipe & Tails

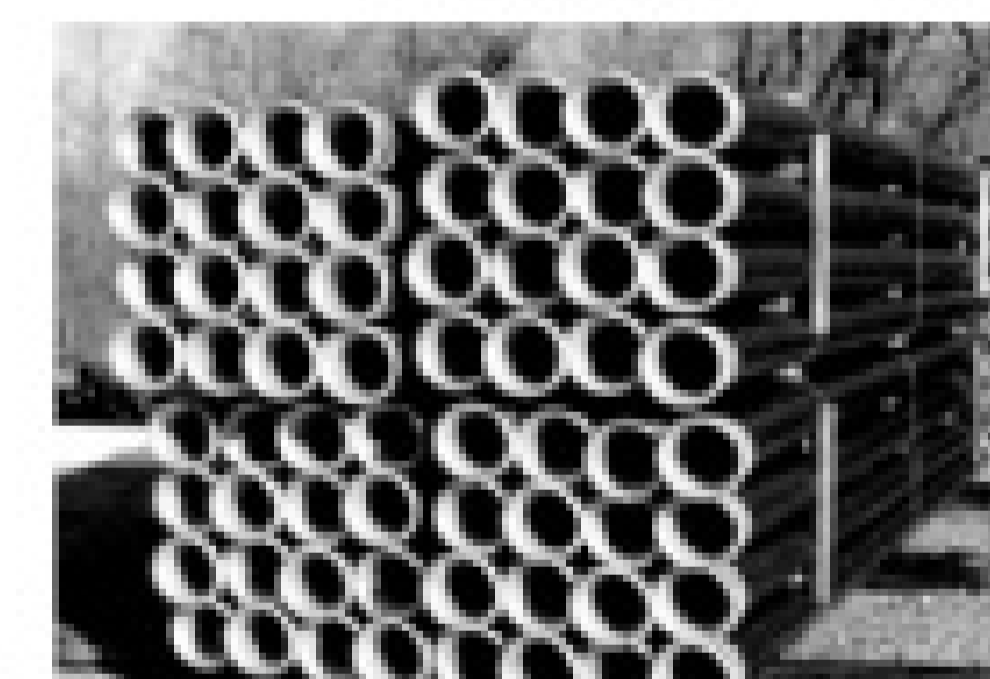

Polybarb™ HDPE pipes and fusible tails available in 4" to 12" diameters up to 40' in length.

Available in weldable, hose insert, and flanged connections. Fittings available from 2" to 12".

Industrial Vac Tubes

We can fabricate aluminum vacuum evacuation or suction tubes per your specifications. Using the Bauer Coupler or Anfor Coupler.

Bauer Pipe

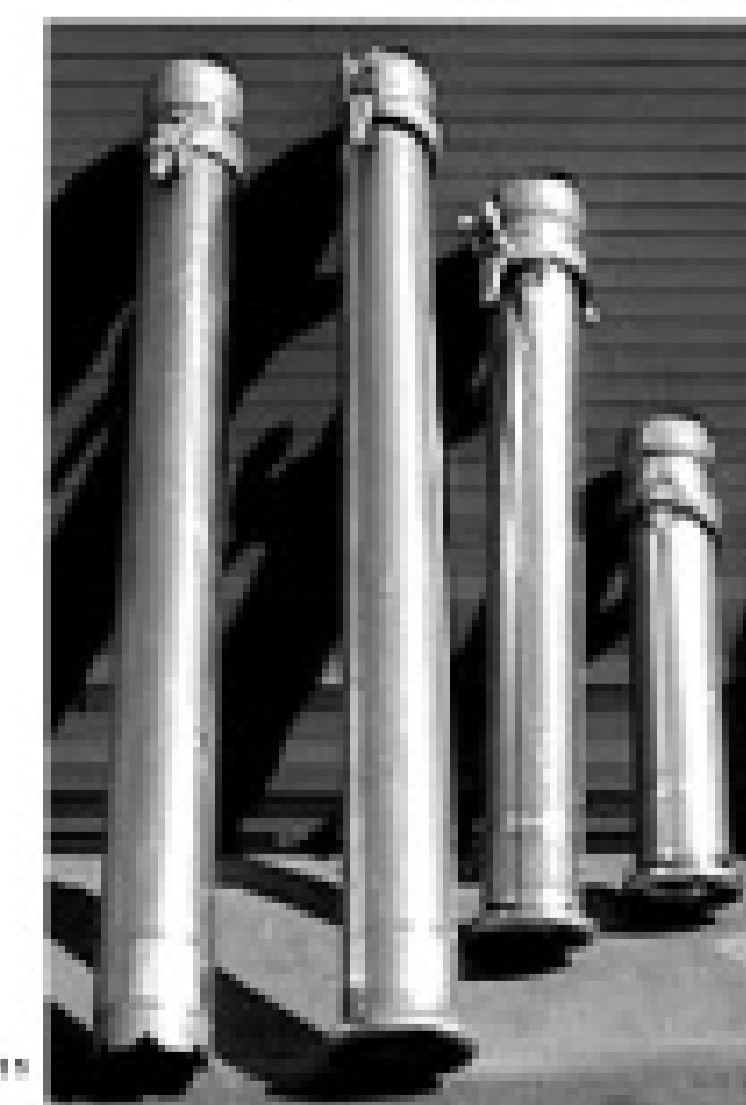

Galvanized piping available in 2" to 12"

800.488.7305 • www.wolfcreekcompany.com

Advance

PUMP & EQUIPMENT INC



**Custom
Pump Trucks
Built to
Your Specs**



**Call Today
For
Professional
Blower
Installation**

Thanks Dave!

Aluminum Hoist/Rear Door
w/NVE 957 Blower System

NVE
DISTRIBUTOR



**6000 Gallon
Short Tanker Trailer**

- Excellent for Septic & Grease Trap Service.
- Call for more Information

**Less Trips =
Less Fuel**



Toolbox Jetter

- Polished Aluminum Toolbox (28 x 28 x 48)
- 10 GPM @ 3000 PSI Water Pump w/Pulsator
- Gearbox Drive - Standard or optional Hydraulic Drive
- Air Rewind Reel w/200' of 1/2" Hose
- Bucket Fill/Drain
- Chrome Guide Rollers on Reel
- Wash Down Gun w/ (4) Quick Connect Tips
- Jet Nozzle - Flushing
- Includes Mounting Brackets

**Introducing the JT1030
\$5,995.00**

Add Jetting To Your Pump Truck

Toll-Free 1.877.557.PUMP (7867)
"Partners in Performance"

Call For A Quote Today!

www.AdvancePump.com
15418 Old Highway Road • Peosta, Iowa 52068
877.557.PUMP (7867) • Fax: 563.557.0961

Supporting the Vacuum Tank

Shopping for a new pump truck, a poster wonders about the best way to support the weight of the tank barrel

This feature in Pumper® reports noteworthy conversations that take place in the Pumper Online Discussion Forum for industry professionals found at www.pumper.com. The forum is split into several topic areas: General Discussion, Business, Parts & Accessories, Portable Sanitation, Pumps & Blowers, Septic System Installation, Septic System Service & Maintenance and Trucks. Simply register with a user name and password and join the discussion!

Information and advice in Overheard Online is offered in good faith by industry professionals. However, readers should consult in depth with appropriate industry sources before applying such advice to a specific business situation.

Overheard Online

Trough or no trough?

Question:

I need some help. I am having a tank fabricated and the company does not think I need a full-length trough on the tank. They say all I need is a 4- or 5-foot piece up front and the same in the back. Also, the builder doesn't recommend using any membrane (rubber, wood) between the trough and frame rail of the truck. This is the only manufacturer I have come across that deletes these items. Is this a big deal or should I spend my money on something else?

Answers:

Dropping the membrane between the tank and frame is like leaving the rubber out of motor mounts; it should have rubber (lasts longer than wood) between the tank and frame or you will hear clunking every time the tank moves. The tank should not be mounted solid. It should have at least one spring mount in front or back for flex. The hose trays should be full length. It is much easier on the hose. Every time the hose flexes, it loses some life. On the back of my truck I have three hose hooks, giving the hose less bounce, less flex and more life.

◆ ◆ ◆
We have always manufactured full-length skids made of 1/4-inch material. I don't think anyone could argue that it gives greater strength to the barrel. Tanks always collapse from the top down, never from the bottom up! A full-length skid would act as a rib. Also consider equal, even weight distribution as your tank and truck frame twist and contort.

I have seen skids that had been stitch-welded with cracked welds from twisting, contorting and varying pressure points. Skids that are 100-percent welded prevent moisture entrapment. This entrapment will cause extreme corrosion problems down the road. I have also seen skids made of lighter material buckling.

Wood, plastic or rubber act as an isolator between skids and truck frames. The idea is you don't want to lock down the tank to the frame, but allow the movement it needs. This becomes more important with larger diameter and longer tanks.

◆ ◆ ◆
I strongly recommend full-length hose trays and rubber skids with a stainless-steel channel between the rubber and tank. Wood holds moisture and shortens your barrel life. The stainless-steel channel is a barrier you should have. Wood will not last the life of the tank; it will either compress or rot and increase stress on your tank over time. You should get the best quality features to ensure longer tank life.

◆ ◆ ◆
I have seen a lot of other trucks with just 3-foot pads for resting the tank on the truck frame. All of these trucks are for oilfield work, so they have to be certified. Keep in mind that these tanks have two or more stiffeners around the diameter of the can, and they have six pads, two in back, two in the middle and two at the front of the tank. All have hoists, so they are not mounted to the truck except by

Dropping the membrane between the tank and frame is like leaving the rubber out of motor mounts; it should have rubber (lasts longer than wood) between the tank and frame or you will hear clunking every time the tank moves.

hinges at the back of the tank. For what it's worth, my new tank has six 4-foot rails for resting on the truck. I installed two stiffeners around the diameter of the can as well. It also has a hoist.

◆ ◆ ◆
With hoist units, you have your rear hinges as a solid point and the front lift cylinder is also a capture point. When the hydraulic cylinder is collapsed down, it has not bottomed out steel on steel, but nested on a bed of oil. So hoist units will float and have some movement. The full-length skid may not play the role as they do on a non-hoist tank. In any event, full-length skids give greater strength and integrity to the barrel.

◆ ◆ ◆
It's true the tank is not tied down, and there is movement. But when the hoist is down all the way, there is not enough oil left in the cylinder to act as a cushion. I have pads under the front corners of the tank and on the truck frame showing wear to prove that.

I agree that when a tank collapses, it collapses from the top and not the bottom (I've had two do that to me), but the top has no more support than the metal of the can itself (and from the baffles if you have them). The bottom does have support though.

How much more strength does a full skid give a can as opposed to shorter pieces? There is room for argument that shorter pieces of rail have enough support, depending on where they sit (I think the middle of the tank has to be supported as well), and it would weigh less. Not very much less, but as they say, "look after the ounces and the pounds will take care of themselves."

PTO or separate gas-powered pump?

Question:

I was asked which is more economical, a small gas-engine driven vacuum pump or a power takeoff-driven vacuum pump running off the transmission? I didn't have an answer and figured maybe you guys could help. I figured since most trucks run with a PTO, it is probably cheaper. I'm sure the numbers have already been crunched.

Answers:

Any diesel engine is going to be far more efficient than a small gas engine, and less polluting as well. I also think of the cost, space, and weight issues of carrying around and maintaining an extra pump. The PTO is definitely more convenient.



The real issue is "how many CFMs do you need?" Even a small pump will produce vacuum, but it may take forever. Large vacuum pumps require big horsepower, making PTOs more efficient.



Most small gas engines are not designed for long life or heavy use, and will need to be repaired/replaced more often than the PTO. Then there is the hassle of having more maintenance records, separate fuel sources to manage and maybe different oils and filters.



The best thing about the PTO is if I can drive to the jobsite, I am sure the PTO-driven pump will work all the time, unlike a gas-powered auxiliary engine that will refuse to start when most needed. ■

What's Your Opinion?

Pumper welcomes letters from readers responding to articles we publish or offering comments and opinions of interest to the industry. You can submit your letter by:

MAIL: Pumper, P.O. Box 220, Three Lakes, WI 54562
FAX: 715/546-3786 ■ E-MAIL: editor@pumper.com

All letters must be signed. Please limit your letter to 500 words or less. We reserve the right to edit all letters for length and clarity.



Get a Life!

...with software that will give you your life back!

Summit™ XP Service Profit Builder™

Customer & Job Tracking
Reminders & Repeat Jobs
Dispatching & Mapping
Parts Inventory
QuickBooks® Link
...and much more!

DEMOS ONLINE!

Demo DVD/CD also available

Ask about our other software programs for:

- Portable restroom & other rental businesses
- Sales Contacts • Incentives
- Fleet Maintenance (Vehicles/Equipment)

Easiest to use!

...Over 25 years experience



Ritam Technologies, LP

Sales: 800-662-8471 Email: info@ritam.com Web: www.ritam.com

Offering a Complete Line of Portable Toilet & Septic Needs

Introducing our two newest
All-Natural Products!

Nano Eliminator Deodorant and Graffiti Remover

Non-Toxic
Environmentally Friendly

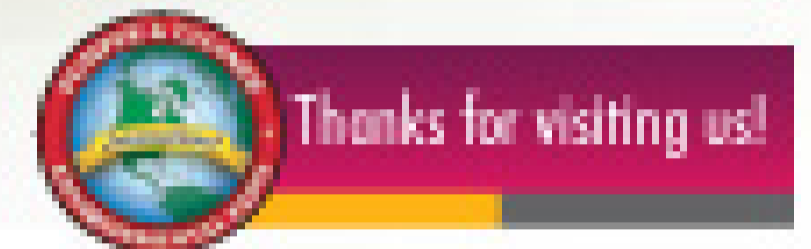

Del Vel Chem
C O M P A N Y



Serviceing the Industry with Pride Since 1994

250 Old Marlton Pike • Medford, New Jersey 08055
609-714-2424 • Fax: 609-714-3030 • 800-699-9903

435 GALLON VACUUM TANK



- 1/4" Aluminum Construction
- Conde Super 6 Pressure Vac Pump with 5.5 hp Honda Electric Start
- 12 Volt Water Pump
- 300 Waste/135 Fresh
- 25' Hose and Wand
- 2" Sight Eyes in Waste
- Sight Tube on Fresh Water
- Completely Self-Contained
- Ready to Work

OTHER SIZES AVAILABLE

Robinson Septic Service Inc.

125 Rockrimmon Dr., Bellefonte, PA 16823 • t: 814.353.0263 • email: honeydippers@aol.com

1.800.252.3848 • www.robinsonseptic.com

We've Got You Covered

Whatever you need in ground protection mats

AlturnaMATS

Toughest mat in the industry. Supports 60 ton vehicles.

VersaMATS

Perfect for vehicle or pedestrian traffic.

Mobile Matt™

Unique waffle tread. Slightly lighter weight.

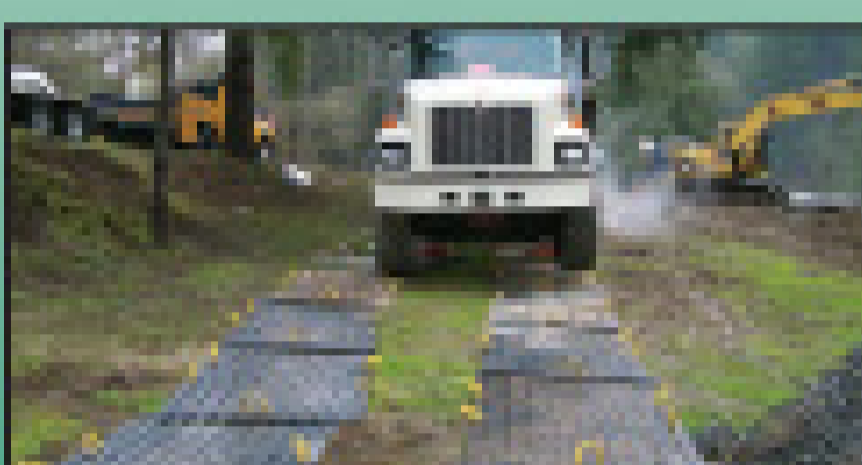

AlturnaMATS continues as the world's largest producer of quality ground protection mats.

Call for the name of your nearby dealer:
888-544-6287



One-Piece Plastic Outrigger Pads
Available in a variety of sizes.

AlturnaMATS®

sales@alturnamats.com

www.alturnamats.com



Flexible and Affordable Financing Options



Financing for New and Used Equipment:

Trucks

Tanks

Trailers

Toilets

Cameras

Jetters

also Computer Hardware & Software



7 Church Road Hatfield, PA 19440
Phone: 800.422.1844 Fax: 888.883.9380
Visit our website: www.libertyfg.com

COMMERCIAL EQUIPMENT FINANCING
CALL 800-422-1844

Come In We're

OPEN

www.pumper.com

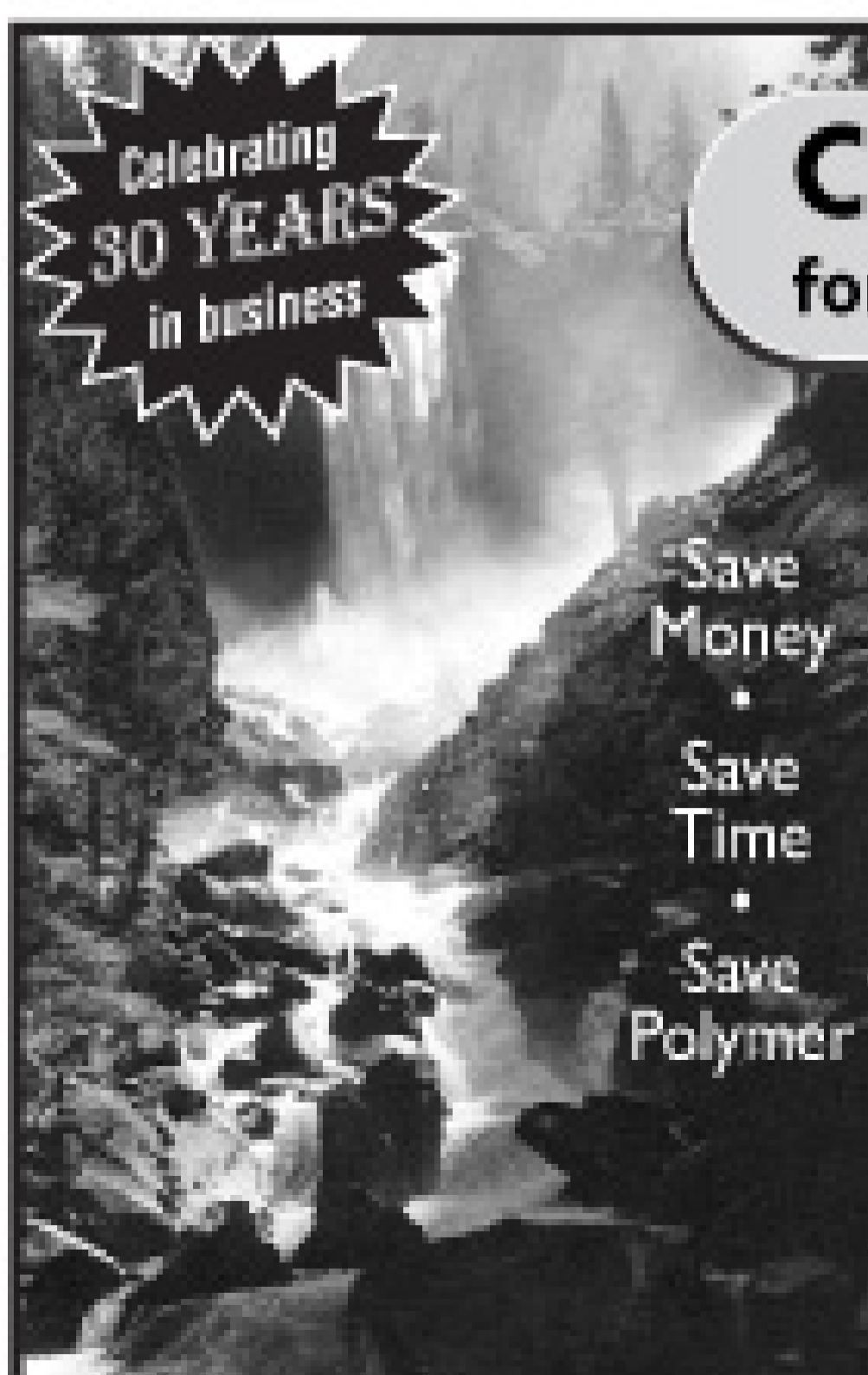

Save Money
Save Time
Save Polymer

Coagulants and Flocculants for Septic, Grease, Municipalities and Industry

- Dewatering polymers for all dewatering equipment
- All forms: Dry and Emulsion
- Variety of packaging sizes to meet customer needs
- Both East & West coast shipping points
- Expert technical staff
- Specific solutions for our customers

Call Toll-free:
877.771.6041

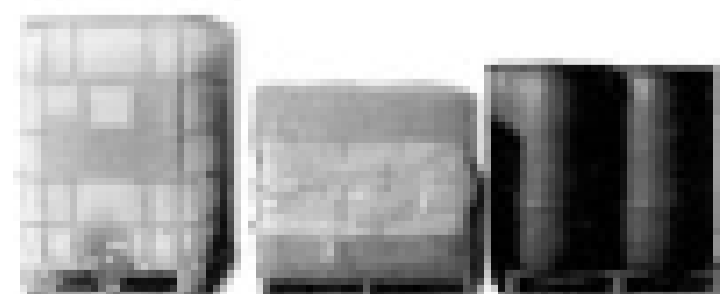

Aqua Ben Corporation
1390 N. Manzanita St. • Orange, CA 92867
www.aquaben.com • sales@aquaben.com

Refuse Systems



Your truck specialists in the solid and liquid waste industries.

If you are in the market for a refuse vehicle, make Rush Refuse Systems your resource. We have one of the largest inventories of work ready trucks in the country, representing the industry's leading brands. Whether you need to buy rent or lease, we have a full spectrum of financial resources available. And, we support you through our Rush Truck Centers network of over 50 locations — with an extensive parts and accessories inventory, highly skilled ASE-certified service professionals and exceptional body shop capabilities.



Peterbilt 340 Industrial Vacuum Trucks

Automatics and Standards in stock ready for delivery. DOT 407/412 3150 Gallon Cusco units. Moro PM100 Pump, Hydraulic full opening rear, Vibrator Box, Air actuated valves, Full Walkway with handrail, 20 Ton Dump Capacity Cylinder.



Peterbilt 340 Standard Vacuum Trucks

Automatics and Standards in Stock ready to go to work. Non Code 3600 Gallon Pik-Rite Tank. Masport HXL400WV Liquid Cooled Pump, Aluminum Hose Trays, Internal Primary to secondary Piping for clean mount. 10 yr Tank Warranty Standard. Options can be added before delivery. Compare our standard Specs to anybox



2007 Peterbilt Model 357 Roll Off

Pre 07 Emission, Cat or Cummins, 8LL Transmission, 20 Fr/ 44-46 Rears, Air Trac or Hendrickson Suspension, 60K or 75K Hoists, Pioneer and O'Brian Tarpers, Mounted or Cab and Chassis Still Available!



2007 and 2008 Peterbilt Cab and Chassis

Whether you're putting an old tank on a new truck, or custom building a truck the way you've always wanted, call us and choose from a wide variety of models and specs on the ground. Fast shipping available to your destination. Tank dealers and manufacturers welcome.



www.rushrefusesystems.com



877-661-4511

Refuse Sales Team: Gregg Wilkinson | Jason Guzauskas | Jesse Fullilove | Hal Holloway
refusesales@rush-enterprises.com

8810 IH-10 East | San Antonio, TX 78219

PRO Conde VAC

INDUSTRIAL PUMPOUT STATION

There is no substitute for professional pumping equipment

- Ideal for grease trap pumping
- Extremely maneuverable, can go just about anywhere
- Pumps fast, 60 GPM, 60 gal. capacity
- Will not blow 15 amp breakers
- Will not overflow
- Has odor control technology
- Comes complete with everything needed for pumping
- Factory direct with factory support

Call today for complete information and specifications on the industries' most complete portable pumpout unit.

Toll Free 800-367-0972
Westmoor Ltd. P.O. Box 99
 Sherrill, New York 13461

NOW 30% More Power!



Thank you for visiting us in Louisville

On The Web At: www.westmoorltd.com, e-mail: pumps@westmoorltd.com

Steel Tanks

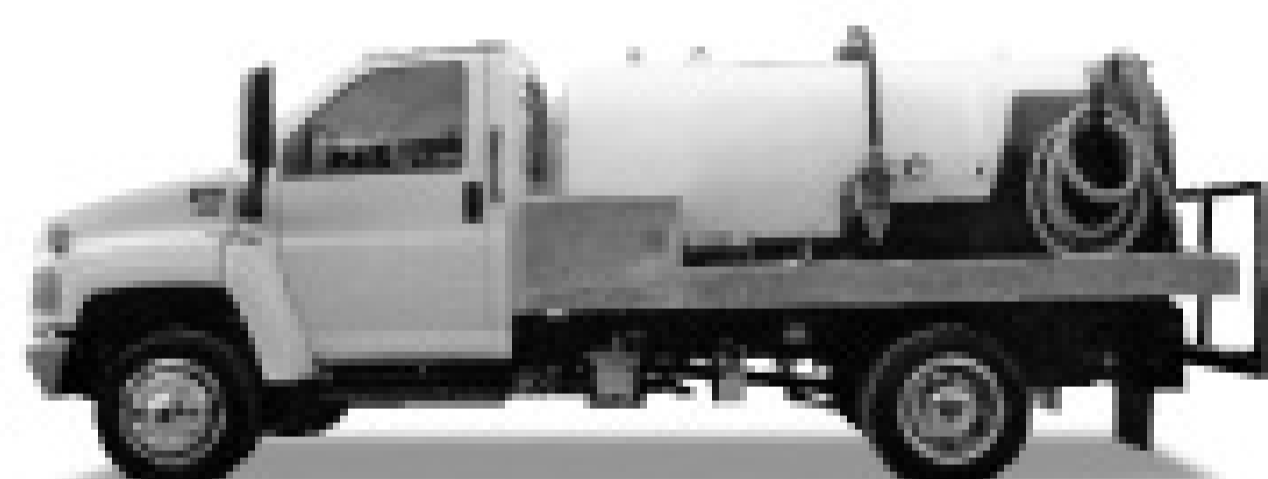

- Polished Aluminum Skirting and Tool Boxes
- 2008 GMC 5500 Duramax, Diesel, Allison Automatic Transmission, 19,500 GVW, 1000 waste, 350 fresh **\$59,000**
 - 2008 Ford, 6.4 Diesel, Automatic, 19,000 GVW, 950 waste, 300 fresh **\$57,000**
 - 2008 Dodge 5500, Cummins Diesel, Aisin Automatic, 1000 waste, 300 fresh, 19,500 **Now Available**
 - 2007 Isuzu or W5500, Diesel, Automatic, 17,950 GVW, 750 waste, 300 fresh **\$55,500**

Aluminum Tanks



- by Amthor 5/16" Thick
- 2008 GMC 5500 Duramax, Diesel, Allison Automatic, 19,500 GVW, 1000 waste, 400 Fresh **\$67,500**
 - 2008 Ford, 6.4 Diesel, Automatic, 19,000 GVW, 1000 waste, 400 Fresh **\$65,500**
 - 2008 Dodge 5500, Cummins Diesel, Aisin Automatic, 19,500 GVW, 1000 waste, 400 Fresh... **Now Available**
 - 2007 International DT-466, Air Brakes, Automatic, Under CDL, 1500 waste, 500 Fresh **\$80,500**
 - Any Brand Truck Available
 - Used Septic and Toilet Trucks Available



Portable Restroom Trailers

Dodge Trucks Coming Soon Check Our Prices.

8 RESTROOM | 10 RESTROOM | 12 RESTROOM | 14 RESTROOM | 16 RESTROOM | 20 RESTROOM

SLIDE-IN UNITS & USED TRUCKS AVAILABLE / MASPORT, JUROP & CONDE VACUUM PUMPS
 CHECK OUR PRICES

LANE'S VACUUM TANK, INC.

3133 VANZORA RD. • BENTON, KY 42025

800.592.3308 • 270.527.9945

We stand behind our trucks and trailers!

Have you seen the Pumper E-Zine?



Go to pumper.com to view the e-zine.

By **Scottie Dayton**

ONTARIO: Provincial Regulations are a Hot Topic

After attending the National Association of Wastewater Transporters Inc.-sponsored Septage/Grease Trap Waste Treatment Symposium in Harrisburg, Pa., last September, Bob "Pepi" Murrell spearheaded the first Rural Waste Water Treatment Expo during the 2008 Ontario Association of Sewage Industry Services conference. More than 85 members attended.

David Bell of Saxe Law Office in Toronto spoke of the liability issues members could face. According to Bell, the government, by taking away disposal options and offering nothing in their place, has increased the challenges of doing business. "Those in the septage industry are faced with a myriad of liability possibilities: personal injury, failure to comply, and the potential of accidentally causing environmental harm," he says.

Bell encouraged members to perform a business risk assessment and look at their hiring practices. "How you hire, with a contract or with a written or verbal agreement, will have a direct bearing on your liability," he says. Bell also suggested scrutinizing contracts with municipalities. He pointed out the importance of understanding exactly what the agreement says about sampling responsibilities, proving what is in a load, and similar issues. Call Bell at 416/962-5882 or e-mail admin@envirolaw.com.

MISSOURI: Funding Assistance for Onsite Systems

Onsite or decentralized systems serve more than 25 percent of Missouri households, but funding assistance to individuals or small communities is limited. To help focus State Revolving Funds and other funding efforts for the greatest good, the Department of Health and Senior Services is asking pumpers to identify, quantify, and prioritize the needs in their areas.

The agency is seeking information about the cost of repairing or replacing different types of onsite systems. This will allow the state to include onsite/decentralized needs in the Clean Watershed Needs Survey. Doing so may lead to increased funding assistance for individuals and small communities. To participate, contact the Onsite Sewage Program at 573/751-6095.



"Duel Power Lid"

Plugs, Lids & Adaptor Rings

Sizes Available: 18", 24", 30" & 36"



Fergus Power Products
Providing "Environmental Products"

The Company who maintains a pulse on the environment!

Toll Free **1-800-243-7584**
E-mail fpproducts@prtcl.com

March 2-5

Ontario Onsite Wastewater Association Conference, Deerhurst Conference Centre, Huntsville. Call 905/372-2722 or visit www.oowa.org.

March 3-5

Minnesota Onsite Wastewater Association Convention, Cragun's Resort, Brainerd. Call 888/810-4178 or visit www.mowa-mn.com.

March 11-13

Northeast Onsite Short Course, Marriott Hotel and Spa, Groton, Conn. Call 978/323-7929 or www.neiwppcc.org.

March 24

Granite State Designers and Installers Association Septic System Conference & Exhibition, Radisson Hotel, Manchester, N.H. Call 603/228-1231 or visit www.gsdia.org.

March 26-29

Portable Sanitation Association International Nuts & Bolts Meeting, Embassy Suites Hotel, Albuquerque, N.M. Call 800/822-3020 or visit www.psal.org.

March 30-April 2

Residuals and Biosolids Conference and Exhibition sponsored by the Water Environment Federation, Marriott Philadelphia Downtown, Pa. Call 703/684-2441 or visit www.wef.org.

April 7-10

National Onsite Wastewater Association Conference, Cook Convention Center, Memphis, Tenn. Call 800/966-2942 or visit www.nowra.org.

April 15-17

North Carolina On-Site Wastewater Treatment Conference, North Carolina State University, Raleigh. Call Joni Tanner at 919/515-1678 or visit www.soil.ncsu.edu, then Training, Short Courses and Workshops.

April 27-May 2

North American Society for Trenchless Technology No-Dig Show, Gaylord Texan Resort and Convention Center, Grapevine, Texas. Visit www.nodigshow.com.

May 12-15

California Onsite Wastewater Association Conference and Exposition, DoubleTree Hotel, Sacramento, Calif. Call or visit 707/579-4882 or visit www.cowa.org.

Oct. 14-15

Delaware Onsite Wastewater Recycling Association Conference and Exhibition, Dover Downs Hotel & Casino, Dover. Call 302/739-9331 or visit www.dowra.org.

Oct. 23-26

Ontario Association of Sewage Industry Services (OASIS) Conference and Expo, Orillia, Ontario, Best Western Conference Centre. Call 877/2020082 or visit www.oasisontario.on.ca.

Nov. 5-9

Portable Sanitation Association International Convention & Trade Show, Hilton Hotel Ocean Beach and Ocean Center Exhibit Hall, Daytona Beach, Fla. Call 800/822-3020 or visit www.psal.org.

Training & Education

Ontario Onsite System Brochure

The Ministry of the Environment and the Ontario Rural Wastewater Centre developed a brochure with information about protecting the environment through the responsible operation and maintenance of onsite systems. Call 416/325-4000.

Effluent Pumps for Onsite Systems

The Sump and Sewage Pump Manufacturers Association is presenting "Effluent Pumps for Onsite Wastewater Treatment: Selecting the Right Pump for the Job," a non-credit training program, on March 14 as part of the Illinois Plumbing Heating Cooling Expo at the Drury Lane Conference Center, Oakbrook Terrace. The program is in its certification stage and will become eligible for CEUs. Call Bev Potts at 800/795-7422 or visit www.ilphcc.com.

Florida

Courses are at the Florida Onsite Wastewater Association's Training Center in Polk City unless stated otherwise.

- March 6 – Master Contractor Maintenance
- March 11 – Onsite Systems: How Are They Approved?, northeast Florida (TBD)
- March 12 – Onsite Systems: How Are They Approved?, northwest Florida (TBD)
- March 25 – Work Smart, Not Hard, southeast Florida (TBD)
- March 26 – Work Smart, Not Hard, southwest Florida (TBD)
- April 7-8 – Master III-Basic Florida Soils
- April 9-10 – Master I-System Design and Function
- April 10-11 – Master II-System Materials and Regulation Requirement
- April 22 – Smart Business Practices: Portable Restroom Rental Industry
- April 23 – Septage and Grease in Florida
- May 6 – Smart Business Practices: Portable Restroom Rental Industry
- May 20-21 – O&M Service Provider Program I, II, III, Miami
Contact FOWA at 407/830-4381 or www.fowaonsite.com.

Iowa

The Iowa Onsite Wastewater Training Center has the following courses:

- March 17 – Basic 101, Calmar
- March 27 – Media Filters, Indian Hills
- May 14 – Drip Irrigation Dispersal Systems, Ankeny
- June 19 – Basic Soils, TBD

Call Annette Adams at 800/362-2127, ext: 6464 or e-mail Dennis Hayworth at dahayworth@dmacc.edu.

Minnesota

The University of Minnesota Extension has these hands-on workshops:

- March 11-12 – General-Continuing Education, Willmar
- March 14 – Contractor Safety/Pipelayer Certification, Continuing Education, Mankato
- March 25-26 – Pumping/Maintaining-Continuing Education, Brainerd
- March 31-April 1-2 – Introduction To Onsite Systems, Bemidji

- April 3-4 – Installing Onsite Systems, Bemidji
- April 11 – Contractor Safety/Pipelayer Certification, Continuing Education, Little Falls
- April 14-15 – General-Continuing Education, White Bear Lake
- April 16-18 – Designing Onsite Systems, Detroit Lakes
- April 22-23 – Inspecting Onsite Systems, Waseca
- April 28-30 – Introduction to Onsite Systems, White Bear Lake
- May 1-2 – Installing, White Bear Lake
- May 5-7 – Pumping and Maintaining, Mankato
- May 5-9 – Pumper/Maintaining and Service Provider Combo, Mankato
- May 6-9 – Service Provider, Mankato
- May 29-30 – Soils, Brainerd

Call 800/322-8642 (612/625-9797) or visit www.extension.umn.edu.

Missouri

The Department of Health and Senior Services is offering the following training professional CEU courses:

- March 4 – Basics of Onsite Wastewater, El Dorado
- March 5 – Basic Drip Irrigation Design and Installation, El Dorado
- March 13-14 – Advanced Installer, Jefferson City
- March 18-19 – Operation and Maintenance, Sedalia
- March 25-26 – Advanced Installer, Springfield
- March 25 – Troubleshooting, Columbia
- March 26 – Hydraulics, Columbia
- April 15 – Troubleshooting, Springfield
- April 15-16 – Advanced Installer, Cape Girardeau
- April 16 – Hydraulics, Springfield
- April 22 – Basics on Onsite Wastewater, Chillicothe
- April 23 – Basic Drip Irrigation Design and Installation, Chillicothe
- May 6 – Troubleshooting, Grandview
- May 7 – Hydraulics, Grandview
- May 20-21 – Operation and Maintenance, Camdenton
- May 27 – Troubleshooting, Maryville
- May 28 – Hydraulics, Maryville

Call 573/526-6095 or visit www.dhss.mo.gov/Onsite.

New Hampshire

The New Hampshire Department of Environmental Services is offering the following courses at its Concord auditorium:

- April 2 – Installers, review class
- April 8 – Installers, exam
- April 16 – Onsite Designers, review class
- April 22 – Onsite Designers, exam

Call NHDES Public Information Center at 603/271-2975.

North Carolina

North Carolina Soils and On-Site Wastewater Training Academy is offering the following courses:

- April 2 – Sediment and Erosion Control Workshop, Raleigh
- April 22-24 – Land Application/Residual Operator, Raleigh
- April 23-25 – Subsurface Wastewater Operator, Raleigh
- May 5-8 – Spray Irrigation Systems Operator, Raleigh
- May 13-14 – Writing A Certified Nutrient Management Plan, Raleigh
- May 20 – Introduction to Decentralized Wastewater, Fletcher
- May 21-22 – Onsite Wastewater System Inspector, Fletcher

Call Joni Tanner at 919/515-1678 or visit www.soil.ncsu.edu/training.

Pennsylvania

The Pennsylvania Septage Management Association offers the following training on March 19-20 at Grantville:

- Vac-Truck Training and Certification
- Basic Onlot Wastewater Treatment System Inspection
- Advanced Onlot Wastewater Treatment System Inspection
- Standards Refresher

New Jersey Septage Management Association members qualify for PSMA member tuition fees. Call Jackie at 610/350-0590 or visit <http://psma.net>.

Rhode Island

The University of Rhode Island's Onsite Wastewater Training Center offers these professional development workshops at its Kingston campus:

- April 17 – Bottomless Sand Filter Design and Installation
- April 30-May 1 – Conventional Onsite Wastewater System Inspection
- May 8 – Innovative and Alternative Technology Overview
- May 14 – Hands-On Component Installation
- May 29 – Innovative and Alternative Systems Field Tour
- June 4-5 – Innovative and Alternative Systems Operation and Maintenance
- June 18 – Soils Basics for the Onsite Wastewater Contractor (contact Mark Stolt)
- June 25 – Bottomless Sand Filter Design and Installation

Call Holly Meehan at 401/874-5950 or Mark Stolt, when directed, at 401/874-2915 or visit www.uri.edu/ce/wq.

Washington State

The Washington On-Site Sewage Association and Washington State Department of Health in cooperation with Washington State University are offering these certification courses at the training center in Puyallup unless stated otherwise:

- March 5 – Markup and Profit
- March 13 – Control Panel Wiring
- March 19-20 – Exam Review
- April 2 – Maintenance Basics
- April 16 – Pumpers
- April 23 – Design/Install Subsurface Drip Systems
- May 6-7 – Combined Basics of Onsite Sewage
- May 14-15 – Installation Basics, Part 2
- May 20 – Mounds/Sand Filters
- May 22 – Maintenance Basics, Bremerton

Call John Thomas at 253/770-6594 or visit www.wossa.org.

Wisconsin

Wieser Concrete has a 6-hour, general continuing education seminar that provides the necessary credits for installers, sanitarians, designers, and others working in the onsite wastewater treatment field,

- March 6 – Shell Lake
- March 13 – Fond du Lac
- March 20 – Wieser Concrete Maiden Rock Facility
- March 27 – Rhinelander

Call 800/325-8456 or visit www.wieserconcrete.com. ■

Built Better to Perform Better™

Thank you for visiting us in Louisville!

NEW!
Dual Pedestal Reel



Shown: DP7850 OLP

Very strong, yet compact vibration-resistant new design

Better by Design:

- ✓ Engineered for your most demanding vehicle-mounted applications
- ✓ Innovative new heavy duty design
- ✓ Very compact...fits in tight spaces
- ✓ More resistant to vibration
- ✓ Durable, powder-coated finish ensures maximum resistance to corrosion
- ✓ Innovative latching mechanism prevents hose latch-out
- ✓ Ask about Reelcraft's full range of hose reel products

Military Tested

Rely on Reelcraft's Series DP7000 for greater resistance to vibration. Series DP7000 meets or exceeds military Vibration for Truck Transport testing: MIL-STD-810F, 500,000 mile equivalent.

IEA Winner 2006
BEST BRANDS
Hose, cord and cable reels

800-444-3134

reelcraft.com/pumper



Heavy Duty Series 8000

Larger capacity dual pedestal reel

REELCRAFT

Wind Things Up With Reelcraft™

Choice. We offer **MORE** than all the others combined.
More choices of exteriors - *these are just a few!*



More choices of interiors - *many more online.*

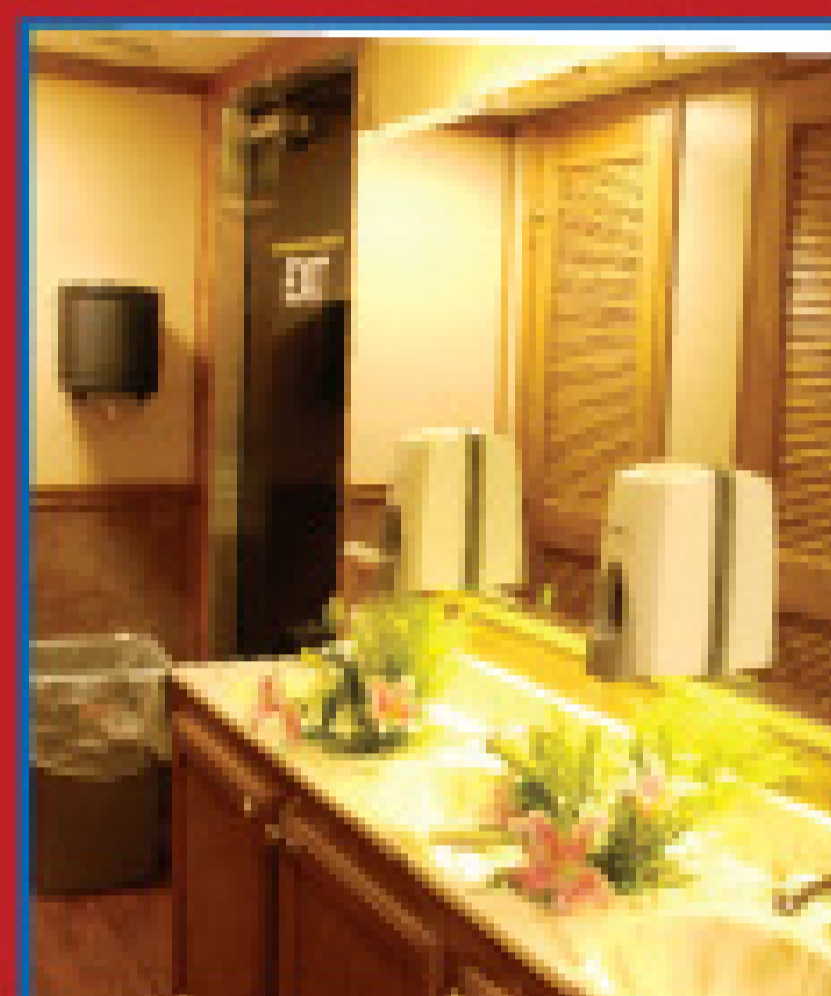

Restroom Trailers | Shower Trailers | Combination Shower /
Restroom Trailers | ADA Trailers | Decontamination Trailers
Hand Wash Trailers | Drug Screen and Lab Trailers

More Choices...

- 75 floorplans to choose from
- Wide range of exterior designs
- Choice of 9 unique interiors or design your own
- More Features
- More Options
- More Functionality
- More value for your investment

AMERI-CAN
ENGINEERING

15886 Michigan Rd | Argos, IN 46501

574-892-5151

Visit our Online Catalog - www.ameri-can.com

About that article,
would you like a copy?

A poster to display in your office?

An electronic file to post on your web site?

Reprints to hand out or mail to potential customers?



Just let us know!

Pricing and options available by
e-mailing sherryd@colepublishing.com
or by calling 800-257-7222

Summaries of past articles at pumper.com

Pumper.

**America's Sales Leader In Aluminum
Truck Mounted Tanks & Tank Trailers**
nationwide - worldwide
Stock Tanks & Trucks
Financing & Lease Plans



1-800-971-7657

www.tstllc.com

email us from our website

6300 GALLON - ONE COMPARTMENT

5454 aluminum (mill finish), Enclosed walkway street side,
 25' hose trays both sides w/full height end caps,
 Center ladder, 3 dished and flared baffles,
 4- top 20" manways,
 3" primary in front manway,
 1-20" manway in rear head,
 Rear sump w/ 2-4" flanges,
 2" sight tube in rear head,
 Betts L.E.D. lights, bumper and
 aluminum wheels

\$62,000

Plus FET
 F.O.B. Arthur, IL



Not actual photo



7000 Gallon - One Compartment

5454 aluminum (polished finish), 13 -5"x2" rings
 Enclosed walkway street side, Full width/ full length hose trays, Center ladder
 3- .250 dished and flared baffles, 3 -top 20" manways, 4" low profile primary,
 Secondary brackets driver side form head, 1- 20" manway in rear head,
 6" flange at bottom of manway, 3- 5" sight tube in rear head,
 4" inlet with riser curb side in rear head,
 Betts L.E.D. lights, bumper and
 aluminum wheels

\$64,500

Plus FET
 F.O.B. Arthur, IL



Not actual photo

A Helping Hand

Arizona's Palmer's Benjamin Franklin Plumbing donates time and supplies for various local charitable causes

When they're not out dealing with plumbing emergencies or jetting out sewer lines, the folks at Palmer's Benjamin Franklin Plumbing are volunteering their time to help out with projects around the company's Youngtown, Ariz., home base.

Work with Habitat for Humanity, the Packages From Home campaign to help soldiers, and many community event sponsorships is all

The Lighter Side

By Jim Kneiszel

We're always looking for ways to help make our community better,"

part of being good citizens in the community located near Sun City Ariz., according to Brian McQuiston, a spokesman for the plumbing contractor.

"It's critical for us to give back.

"When you can pull your team together and work on projects, it's amazing how much you can accomplish. And it builds morale in the company."

Brian McQuiston



The Palmer's Benjamin Franklin Plumbing team of Youngtown, Ariz., includes (back row, from left) Adam Vanderhei, Tony Schuett, Will Clowser, Paul Guitierrez, Chris Hart, Genine Serachie, Jim Lebo, Roger Anderson; (front row, from left) Lynne Bruhne, Nick Culpit, Emie Jiminez, Danny Fontana, Pam Zahn, Brian McQuiston, Connie Chavez, Charisma Jacobo, Bill Palmer, Jerry Hanen; (front) Jess Cordoza.

McQuiston says. "When you can pull your team together and work on projects, it's amazing how much you can accomplish. And it builds morale in the company."

Volunteers from Palmer's Benjamin Franklin Plumbing spent hours helping build this Habitat for Humanity home for a family in Glendale, Ariz.



The company has been operating under the Palmer name for 34 years, and affiliated with Benjamin Franklin Plumbing a year ago, McQuiston says. The company has long looked for charitable opportunities, among them has been sponsoring holes in charity golf tournaments and helping out with children's causes.

Palmer's has spent considerable time on Habitat for Humanity home building projects. McQuiston says employees recruit their families to help out with the houses, and have gone to the high schools where their children attend, seeking volunteers.

"All of our guys volunteer," he says. "Every year we try to top our previous year."

The company has ramped up its fundraising efforts for Habitat for Humanity, earmarking \$5 from every work invoice to go to the program, which helps low-income families build their own homes.

Most recently, the company signed up to provide a drop-off site for Packages From Home, a nonprofit organization that ships supplies to U.S. military personnel serving abroad. If Arizona pumpers want to drop off packages for the soldiers, they can contact Palmer's at 623/933-1375. For more information on the Packages From Home program, go to the Web site, www.packagesfromhome.org. ■

LOCATE WITH THE BEST

WHETHER YOU ARE JUST GETTING STARTED OR YOU ARE AN OLD PRO, you can rely on Prototek for the best flushable transmitter and receiver systems in the industry. **FLUSH AND FIND** Locate underground nonmetallic tanks and lines with our orange

AT-12 flushable transmitter and AR-1 receiver. Locate in cast iron or nonmetallic lines with our blue FT-8 flushable transmitter and FR-1 receiver. Recycle your used AT-12s or FT-8s back to us for credit toward your next purchase. Use your AR-1 for tracing metallic lines or utilities with our **BuzzBox!**

3 watts max power,

Operates at 223 KHz, in 3 ranges. Ground rod and cables included.



Prototek

ECONOMICAL • EASY **800-541-9123**

www.prototek.net email: prototeksales@prototek.net

Orange or blue, the real truth is, nothin's more reliable in the Pumper biz!

TRANSPORT TRUCK SALES, INC.

Ask for Scott or Frank – 888-395-7551
After hours call Scott at 816-590-4076



What Does It Take To Be A "Qualified Chassis"?

- ✓ Pass our 12 point checklist. (We send this out with every quote!)
- ✓ Pass a D.O.T. certified inspection!
- ✓ Pass the warranty inspection!

What Does All This Do For You?

- ✓ Nationwide drive train warranty for 2 years/ 200K miles! (restrictions apply)
- ✓ A tough truck that is ready to work as hard as you do!

YOUR TRADES ARE WELCOME!

**Searching For A Brand New Chassis?
 We Have Them In Stock!**



1999 International 9200i, Detroit 12.7L 430HP, 10-spd, jakes, 291K miles, double framed, AC, new 3360 gal. steel tank, new liquid cooled HXL-400 Masport vac pump.

Call For Pricing!

2-YEAR 200,000 MILE DRIVE TRAIN WARRANTY



2001 Mack CL-713, E-7 460HP, 18spd, jakes, 20# fronts, 46# rears, double framed, new 3800 gal. steel tank, new liquid cooled HXL-400 Masport vac pump.

Call For Pricing!

2-YEAR 200,000 MILE DRIVE TRAIN WARRANTY

IN PROGRESS



2000 Mack CH613, E-7 380HP, 10spd, AC, jakes, double framed, new 3360 gallon steel vac tank, new Liquid cooled Masport HXL-400 Vac pump.

Call For Pricing!

2-YEAR 200,000 MILE DRIVE TRAIN WARRANTY



2002 International 9400i, Cat 475HP, 10spd, jakes, 14# fronts, 46# rears, double framed, new 3360 gal. steel tank, new liquid cooled HXL-400 Masport vac pump.

Call For Pricing!

2-YEAR 200,000 MILE DRIVE TRAIN WARRANTY



2002 International 9100i, Cat C-12 410HP, 10-spd, jakes, double framed, AC, new 3360 gal. steel tank, new liquid cooled HXL-400 Masport vac pump.

Call For Pricing!

2-YEAR 200,000 MILE DRIVE TRAIN WARRANTY



2000 International 4900, DT-466E 230HP, 6-spd, AC, double framed, new 2300 gallon steel vac tank, new Jurop PN-84 vac pump.

Call For Pricing!

2-YEAR 100,000 MILE DRIVE TRAIN WARRANTY

Delivery Available Anywhere in the Lower 48!!

Juggler™

The **ONLY** **NSF** **CERTIFIED**,

solid-liquid separator
for grease traps and
septic tanks that's
SMARTER and
GREENER than
a standard
Pumper truck!



ISO 9001
(2000)

labrie
environmental group

Contact Robert Lamarche at 1 514 919-0347 | New video at www.labriegrup.com

**ARMSTRONG
EQUIPMENT
INC.**

MODEL 806B SEELEVEL ANNIHILATOR™

MODEL 806B **SeeLEVEL ANNIHILATOR™**

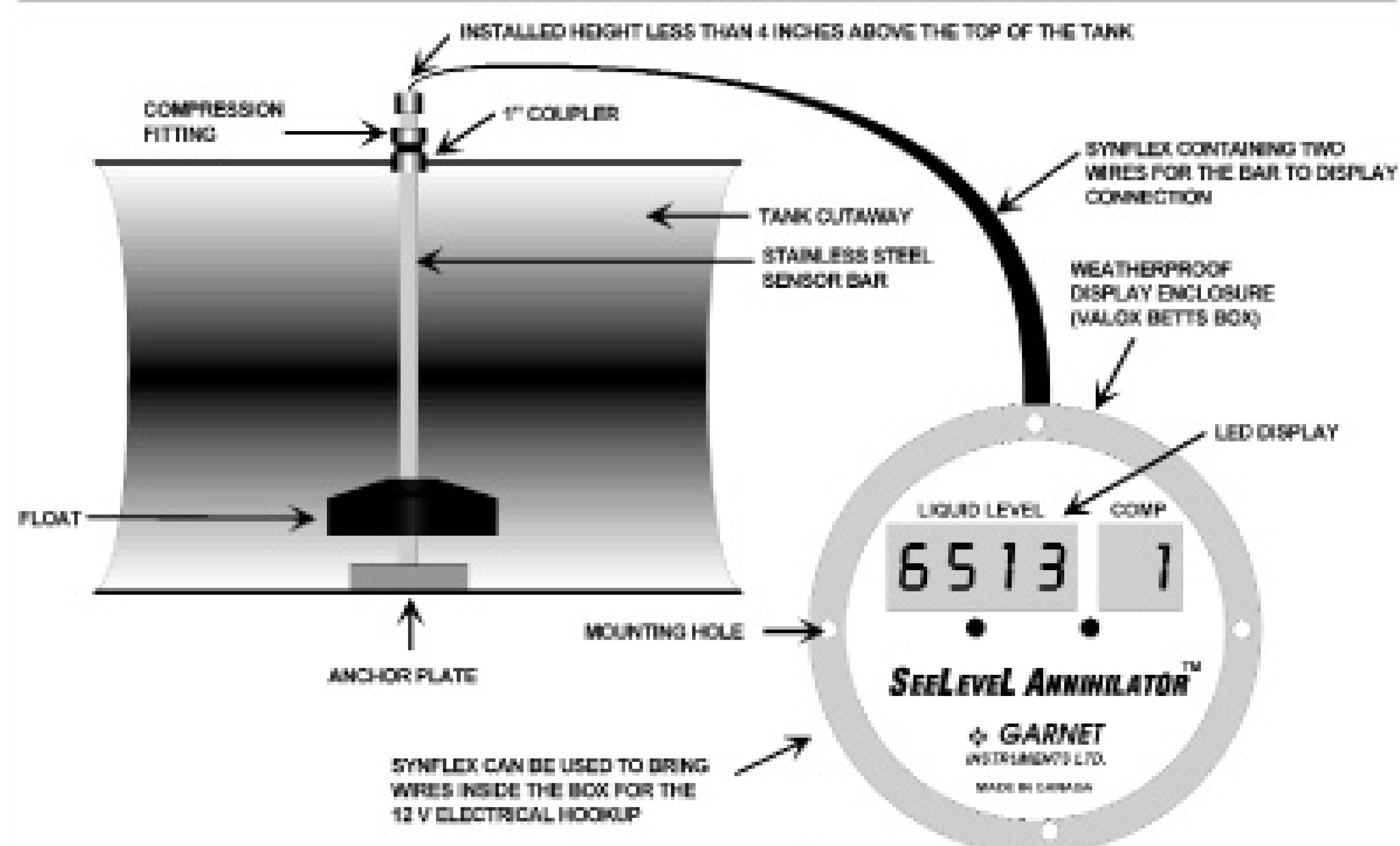

• **Accurate Readings to 1/4"**
Even with vacuum or pressure on the tank. No need to shut down pumping to check tank level.

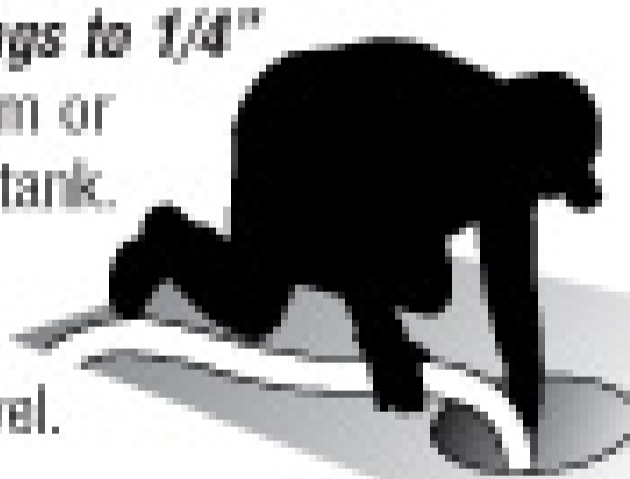

• **Protect Your Pump, Avoid Spills**
See the level of your tank throughout the pumping process.



• **Work Safely**
Can be programmed to control warning devices.



• **Maximize Efficiency**
Avoid unnecessary trips. Can I get one more load, or should I head for the dump? The guessing game is over.



• **Plan Your Route**
Tracking customers tank size allows for improved route planning.



• **Communicate With Your Customers**
Pumping 1500 gallons from a 1000 gallon tank indicates problems



These are all good reasons to equip your next truck with a SeeLevel model 806B liquid level gauge system. The 806B can be programmed to read liquid levels in up to three compartments with only one display. It can also accept up to three alarm settings for triggering a warning light, sounding an audible alarm, or closing a loading valve; all while the tank is loading.



11200 Greenstone Ave. | Santa Fe Springs, CA 90670
800.699.7557 or 562.944.0404 | fax: 562.944.3636
e-mail: sales@vacpump.com | web: www.vacpump.com

To find out if the 806B can benefit your business, contact your tank manufacturer or call us
Toll Free at 1-800-699-7557



48 YEARS OF DEPENDABILITY

TUFF-JON



Thank you for visiting us in Louisville

- One-Piece Construction
- Lightweight
- Rust-Free Hardware
- Wood and Poly Skids
- Large Variety of Colors



Tanks in 60, 105, 225, 300 and 440 Gallon Sizes



90 Gallon Free-Standing Sink



60 Gallon Rinse Tank

— OPTIONAL ACCESSORIES —



7-1/2 Gallon Handwasher



Tuff Jon with Lifting Bracket Assembly



Urinal



Paper Dispenser



Sky Heater



Exceptionally Strong Tank Design

The TSF Company Inc. | 2930 S St. Phillips Rd. | Evansville, IN 47712

Toll Free: **1-800-843-9286** | **812-985-2630** | Fax: **812-985-3671**

E-mail: tsftuffjon@sbcglobal.net | Web Site: www.tuff-jon.com



PORTABLE TOILETS | CHEMICAL TOILETS | HOLDING TANKS | HAND WASH UNITS



PRECISION TANK & EQUIPMENT CO.

www.precisiontank.com | 1.800.258.4197

CENTRAL ILLINOIS Manufacturer Celebrating 40 years of steel and stainless steel tank equipment innovations. Tank sizes from 100 to 5000 gallons in stainless steel or steel.

**Manufacturing plants in Virginia and Athens Illinois bringing quick completion of your pumper truck!
40 years of excellence! PRECISION TANK & EQUIPMENT CO.**

*Standard models or
custom built units*



*Single or multiple
compartments*

Thank you to J.P. Seworootor for the purchase of a new 450 gallon vacuum tank with full opening rear door and Masport vacuum system, low profile parking ramp clean-out unit.

1.800.258.4197

Tired of your Web Site?



**Let COLE Publishing
redesign and host
your web site!**

- Competitive Rates
- Fast Service

For information call **1.800.257.7222** or **colepublishing.com/web**

SAFE FRESH™

Deodorizers

Protection That Pays™



Scientifically Superior!



Online Ordering!



Unmatched Rewards!



Our exclusive ROI Program pays you back with FREE restrooms when you purchase SAFE-T-FRESH Deodorizers. (Special bonus for new customers)

Unique Triple Action Formula

Earn FREE RESTROOMS

Order A Custom Blend

Expert Advice and Service

Express Shipping



www.safetfresh.com

Place Your Order Online
www.safetfresh.com
 Anytime - 24/7
 Safe and Secure

For Assistance Call:
877-ROI-PAYS
 877-764-7297

SAFE  FRESH™
 Deodorizers
Protection That Pays™

OVERLAND TANK, INC.

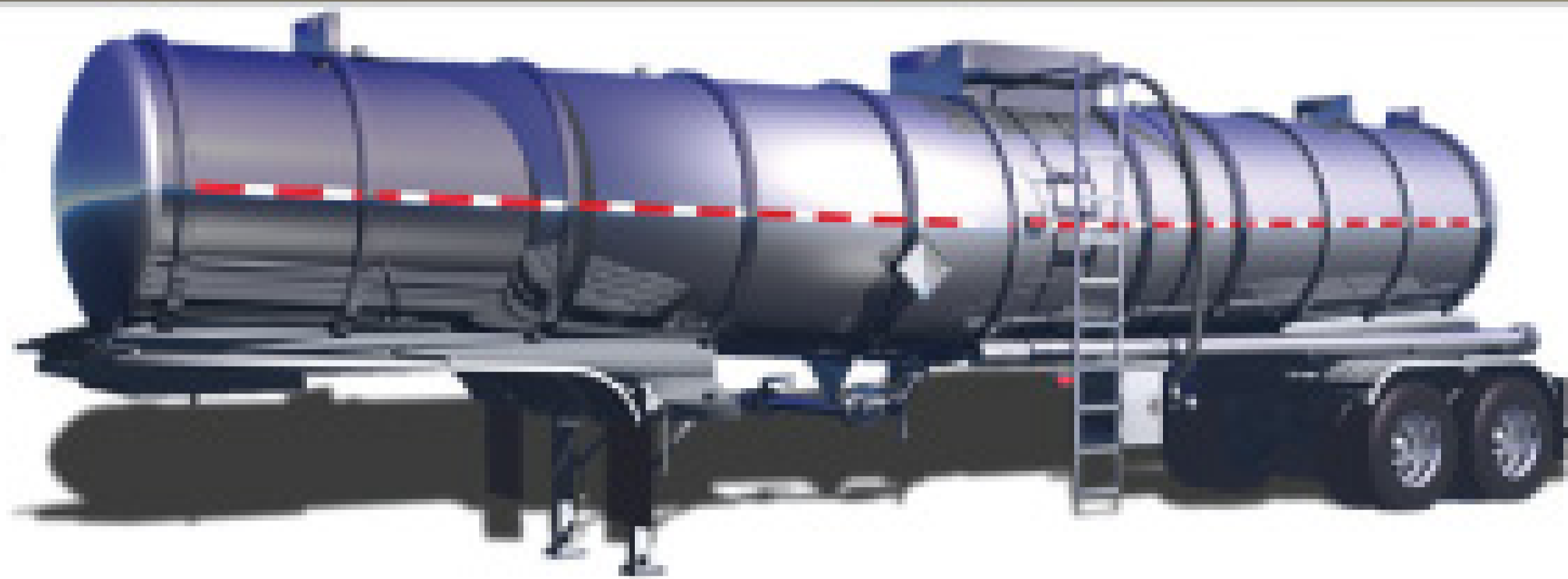

200BBL DOUBLE CONICAL CRUDE OIL TRAILERS



ALUMINUM VACUUM TRAILERS
ALUMINUM TRANSPORT TRAILERS



TWIN DOT 407/412 ACID TANKS

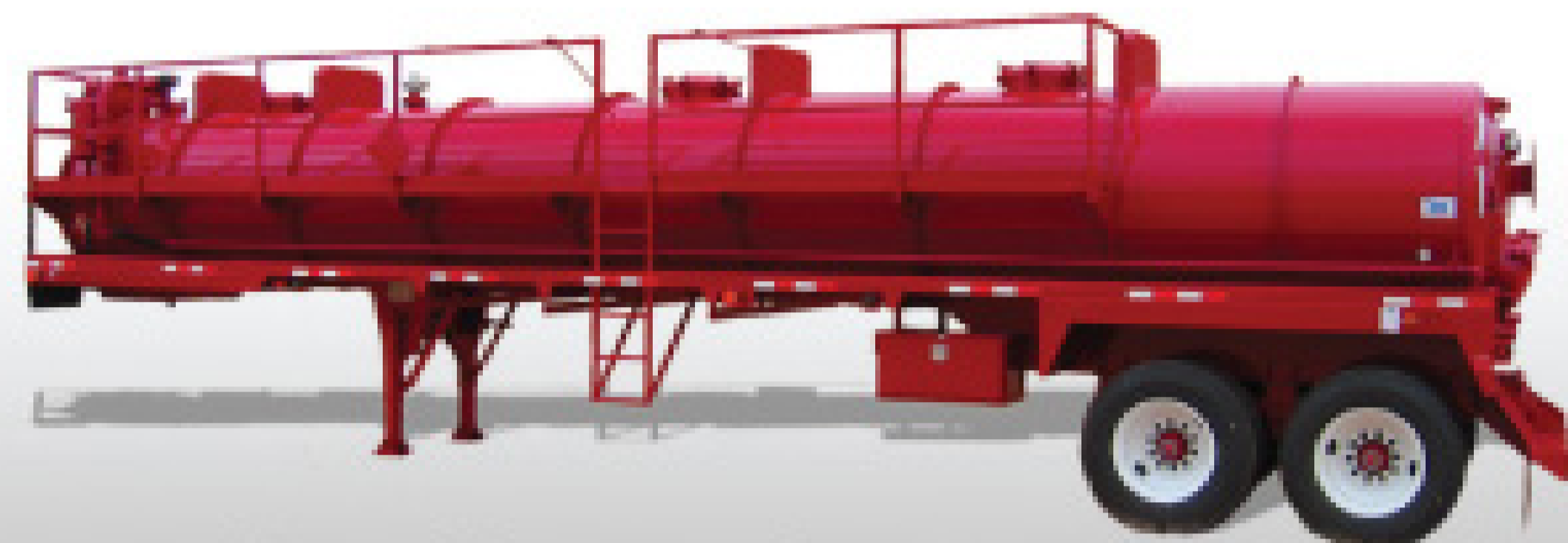

ASME CODE VACUUM TRAILERS



STEEL TRANSPORT/KILL TRAILERS



DOT 407/412 ACID TRAILERS



Thank you for
visiting us in
Louisville.

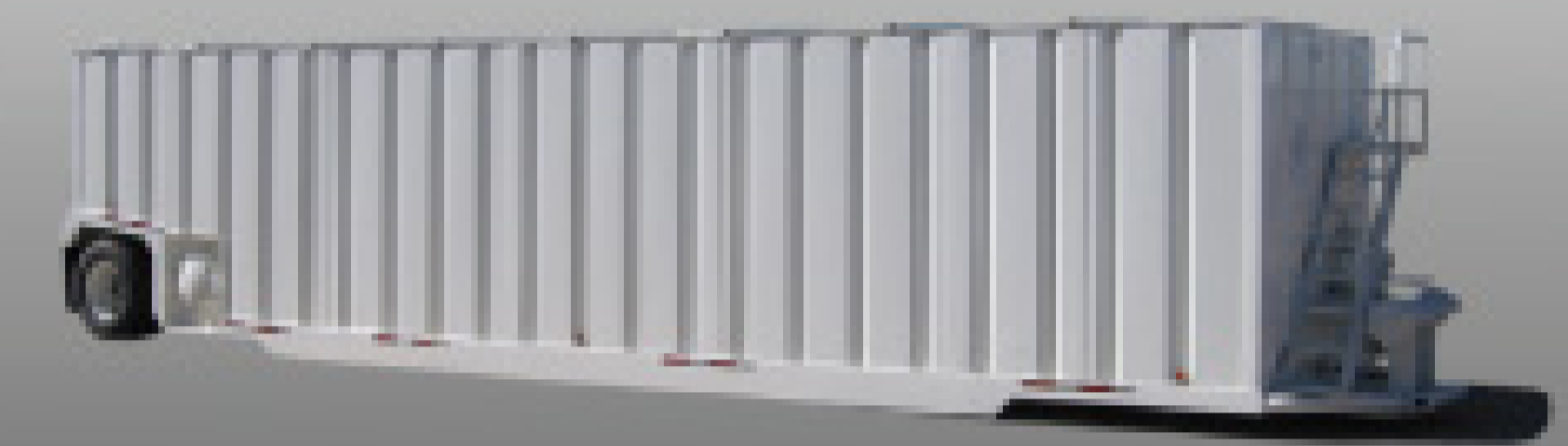

500 BBL PORTABLE FRAC TANK

4725 FM 18 ABILENE, TEXAS 79602 WWW.OVERLANDTANK.COM TOLL FREE: 866.635.7132



GET MORE JETTER
FOR YOUR DOLLAR!



STB2511H-MAX

Full Featured Jets with Powered Reels:

- SK4007V 23 h.p. Briggs 7GPM @ 4000 PSI... \$9950
- STB2511H 24 h.p. Honda 11 GPM @ 2500 PSI... \$11699
- SK3012K 29 h.p. Fuel Injected Kawasaki 12 GPM @ 3000 PSI... \$13995
- STB2020V 35 h.p. Briggs 20 GPM @ 2000 PSI ... \$19699
- STB4018DT 49 h.p. Hatz Quiet Diesel 18 GPM @ 4000 PSI... \$39950

Trailer Models starting at \$7499

www.camspray.com

800-648-5011

Come In
We're

JETTER

www.pumper.com



VAC-CON

PRE-OWNED EQUIPMENT

MORE POWER TO YOU



2002 VAC-CON V390LHA/1000

- 2002 STERLING L7501
- 275 HP / Allison MD3060
- 60 @ 3000 / CUMMINS 130 HP
- Mileage: 35,500

< SOLD >



1997 VAC-CON V312THAE/1300

- Ford LNT8000 / 275HP / MD3060
- 50 @ 3000 Water Pump
- Mileage: 66,703 (kilometers)

RECONDITIONED **\$135,000**



2004 VAC-CON V390LHAD

- 2004 International 7400
- IH 275 HP / Allison MD3060
- 50 @ 3000 / DEUTZ 138 HP
- Mileage: 11,000

\$195,000



1998 VAC-CON VPD3612LHA

- 1999 IH 2554
- 275 HP / Allison MD3060
- 80 GPM @ 2000 PSI
- Mileage: 116,000

RECONDITIONED **\$130,000**



2000 VAC-CON V312LHA

- 2001 IH 2554
- IH 275 HP / Allison MD3060
- 50 @ 3000 / Cummins 110 HP
- Mileage: 122,800

RECONDITIONED **\$135,000**



1998 VAC-CON VPD3690SHA

- 1998 FORD L8501
- CAT 250 HP / 7-SPEED
- 70 @ 2000 / John Deere 4045T
- Mileage: 115,000

< SOLD >



2001 VAC-CON V311LHA/1000

- 2002 Sterling LT7501
- CAT 275 HP / Allison MD3060
- 60 @ 2000 / Cummins 110 HP
- Mileage: 40,000

RECONDITIONED **\$155,000**



1997 VAC-CON V316THA/1300

- 1996 FORD LTS9000
- 300 HP CAT / 10 SPEED
- 80 @ 2000 / John Deere 4045T
- Mileage: 78,500

RECONDITIONED **\$140,000**



www.vac-con.com



Ultimate Lease Hotline:
888-817.1757

969 Hall Park Drive • Green Cove Springs, FL 32043 U.S.A.
Tel: 904-284-4200 • Fax: 904-284-3305
www.vac-con.com • vns@vac-con.com

PUMP VANES

BULLET-PROOF
your pump with
KEVLAR BLADES



DURA FLO BLADES

Features:



- Long lasting performance
- Fully heat-treated material
- Operating temperature to 400°
- Resistant to wear and warpage

Benefits:



- Made in the U.S.A
- Longer rebuild intervals
- 100% guaranteed
- Factory direct

VANES AVAILABLE
FOR MOST PUMPS IN THE INDUSTRY

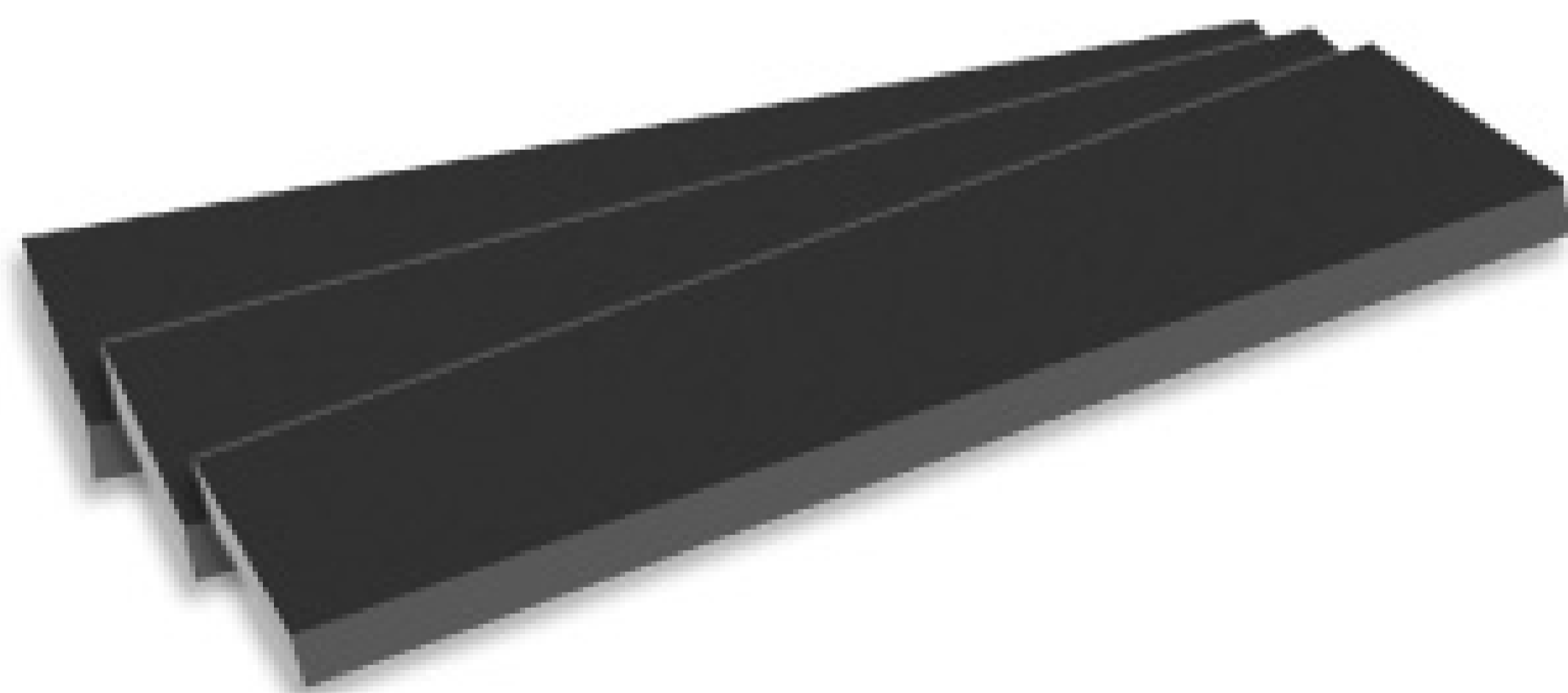

POWER flo

1-800-758-4788

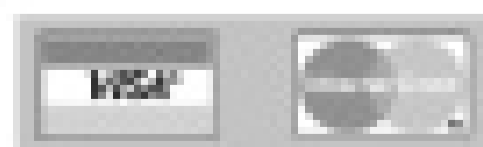

POWERFLO PRODUCTS INC. • 2755 N. Gaviola Ave. • Signal Hill, CA 90806

One Complete Package

promonthly.com

cleaner.com

pumper.com

mswmag.com

onsiteinstaller.com

pumpershow.com

pumpertrader.com

constructionguide.net

septicyellowpages.com

sewerpages.com

COLE Publishing

1.800.257.7222

715.546.3346



Toll-Free: 1-888-848-3727

LaVerne Charlet

email: lctanks@bellsouth.net / fax: 270-898-4055
175 Cascade Drive, Paducah, KY 42003

LCTANKS

Aluminum Slide-In Vacuum Units Portable Restroom Service

300 Gallon Waste / 135 Gallon Fresh

Other sizes and options available

New from *progress tank*

NOW IN STOCK!

300 Waste / 135 Fresh
Masport or Conde pump
Honda electric start
ShurFlo water pump

\$8,500

M.S.R.P.

Totally self contained!



PORTAVAC portable restroom service trucks

NEW! 2008 Mid Range Kenworth, Non-CDL

Factory Built with a 10 Year Tank Warranty

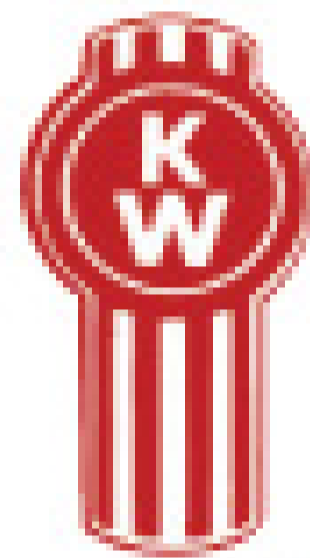

2008 Kenworth T300 - 22,000 GVW

Cummins diesel, Allison automatic,
Hydraulic brakes, Air Conditioned, AM/FM
Air suspension drivers seat, R.H. electric window
Electric door locks, Turbo exhaust brake

1700 Gallon PORTAVAC

400 fresh / 1300 waste
Masport HXL 4 Vac pump
with pre-filter, Burks DC 10 wash down,
Hot shift PTO w/ remote 4" Discharge,
Unit hauler and tow package.

\$75,100

Lease from **\$1030.** mo.



ALUMATANK

3600 Gallon ALUMATANK

Masport HXL15, 360 CFM Pump, Tool Box
2008 Peterbilt 340

Cummins diesel,
10 Speed Transmission

\$104,900

Plus FET

Lease from **\$1,330** mo.

Nurturing the Nest Egg

Market watchers warn of retirement investment pitfalls that can stall or drain funds earmarked for the golden years

By Ted J. Rulseh

Just for fun, try searching the Internet under “mistakes investors make.” You’ll find articles that list 15 mistakes. Or four. Or 18. Or seven. Or 10. And almost every list will include mistakes that others don’t.

Mistakes. We all make them. But judging from all these articles, and all the errors so many of us commit, it’s a wonder anyone makes it to retirement in one financial piece. Of course, most of us don’t make catastrophic blunders, like betting our life savings on a hot tip involving commodities markets. Still, it’s worthwhile now and then to remind ourselves where we can go wrong if we’re not careful.

So, here are some common investment mistakes, pulled from a variety of sources believed to be reliable. In no particular order of importance:

1. Expecting too much. The Merriman Berkman Next money management firm cautions against demanding perfection in order to be satisfied. “We’ve all known people whose attitude is that nothing is good enough for them,” principal Paul Merriman writes in an article on the firm’s Web site. “People who can’t stand to have anything but ‘the best’ are rarely successful at investing.”

Indeed, as a wise man once said, “The perfect is the enemy of the good.” No matter what investments you own, there will always be something performing better.

If you pay attention to that, you’ll tend to jump constantly from one investment to another — and do worse than if you stuck to a long-term plan.

2. Following fads. Remember the dot-com boom and bust in 2000? That wasn’t the first fad, and it won’t be the last. Fad-following is a key reason many people get the traditional “buy low, sell high” advice exactly backwards, according to Cathy Tuckwell, a Certified Financial Advisor in Toronto, Canada.

Fad investors tend to buy the “popular” stocks of the day, which typically become fashionable for brief periods. Many people invest at the height of a trend, just in time to ride it downward, Tuckwell says. She advises looking critically at prospects for an investment’s future performance — not just past performance.

3. Taking too little risk. Merriman observes that some people are afraid to lose any money at all. They want everything secure and

guaranteed — but that isn’t possible. “Very low risk almost always equates with low return,” Merriman says. “If you put your emergency money in a bank account and earn one percent, you may think you’re taking no risk. But in fact you are taking the very real risk that inflation will rob your money of its purchasing power.” It’s the same with money we invest for retirement.

4. Holding on to a loser. When an investment heads seriously south, it can be hard to admit having made a mistake and sell. The tendency is to try and hold on until the investment comes back at least to the price we paid.

“Not every investment decision you make will pay off,” says Dan Kiley, chairman and chief compliance officer with Retirement Corporation of America. “When you do make a mistake, acknowledge the error, sell the shares and invest in something more promising. The longer you stay anchored, the more money you will have tied up in assets that may never return what you originally paid for them.”

5. Taking advice from talking heads on TV. “These programs should come with a big disclaimer: For Entertainment Purposes Only — because that is just what they are,” says John Nyaradi, president of Ridgeline Media Group LLC and owner of Wall Street Sector Selector. “They’re fun to watch and provide fast moving commentary, but if you’re investing according to what you hear on television, you are doomed to failure.”

The “hot tips” you hear on these programs are already common knowledge in investment circles. Whatever good news the commentator is peddling, you can bet it’s already factored into the investment’s price. That means you won’t get a bargain.

6. Having a big head. “The majority of people (though men are more guilty of this than women) think they are better than average at a variety of tasks, such as driving and investing,” says Roger Ibbotson, Ph.D., chairman of Ibbotson Associates, a financial diversification company in Chicago. “But by definition, a majority of people can’t be above average. This unrealistic assessment of one’s own investing prowess causes investors to overtrade and pay the resulting higher fees and taxes.”

7. Putting too much faith in brokers. Investment sage Warren Buffett has asked

Ted Rulseh is the COLE Publishing editor of *Cleaner*®, *Onsite Installer*™ and *Municipal Sewer & Water*™ magazines. Readers can direct inquiries to him by contacting this publication at 800/257-7222 or e-mailing editor@cleaner.com.



“Not every investment decision you make will pay off. When you do make a mistake, acknowledge the error, sell the shares, and invest in something more promising.”

Dan Kiley

rhetorically why people drive Rolls Royces into the city to get financial advice from people who rode in on the subway. Brokers may know more about investing than the average person, but if they really knew which stocks and funds were the best, they would have long since retired. It’s wise to do research as a check against what a broker recommends.

8. Taking advice from amateurs. If we have a toothache, we go to a dentist. Yet many of us, when dealing with our financial health, put trust in “hot tips” or hearsay from friends, family members, or co-workers who have no real training or credibility. “The lure of the hot tip is all but irresistible to some investors eager to find a shortcut to wealth,” Merriman says. “Unfortunately, many investors have to learn the hard way that there are no reliable shortcuts.”

9. Trying to time the market. It’s tempting when the market gets rough to try and pull out at a high point, then try to get back in on the next upswing. Unfortunately, not even professionals can do that. No one can predict at any given time where markets will go. Furthermore, many stock market gains take place in short bursts. Those sitting on the sidelines miss those opportunities.

10. Procrastination. The specter of mistakes can be intimidating, but perhaps the worst investment mistake is to delay.

“Procrastination takes many forms,” says Merriman. “You don’t start saving for retirement until it’s nearly on top of you. You know you should review your investments, but other things always seem more pressing. You think you’ll catch up later when the market is better, when you’re making more money, when you have more time. And there’s the irony, because the longer you wait, the less time you have. Every day you delay is a day of opportunity that you can never get back.”

Most of us have probably made one or more of these mistakes at one time or another. And there are many more we could make that are not listed here. If we’re going to make mistakes, the goal should be to make little ones instead of big ones and, above all, keep trying to get better. ■

When it's forty miles out and forty miles back,
Pump failure is not an option.



When you need to trust your equipment, insist on NVE vacuum pumps.



Designed and built with the customer in mind – resulting in dependable, high performing pumps that are easy to install, operate and service.

www.natvac.com

800-253-5500 - 2670 Aero Park Drive - Traverse City, MI 49686

NVE

Powerful. Performance.

HOSE & HOSE ASSEMBLIES

Celebrating 57 Years

FEATURING QUALITY
HOSE AND COUPLING PRODUCTS BY:

Abbott
Rubber Co., Inc.

Kanaflex

BANJO

GOODYEAR

PLASTIFLEX

Parker
Industrial Hose



PIRANHA

tigerflex

O.E.M. INQUIRIES INVITED!

MANUFACTURED TO YOUR EXACT HOSE NEEDS BY THE LEADING SOURCE IN HOSE FABRICATION

OVER 20 DIFFERENT TRANSFER HOSE CONSTRUCTIONS AVAILABLE

CALL US TODAY FOR A PROMPT QUOTE OR CATALOG

1-800-852-1855 FAX: 847-952-0156

e-mail: sales@pumperhose.com

NEXT DAY
SHIPPING AVAILABLE
FOR ALL
STOCK ITEMS

ABBOTT

RUBBER COMPANY, INC.

1700 NICHOLAS BLVD. ELK GROVE VILLAGE, IL 60007 www.pumperhose.com



(800) 800-7575

(713) 675-7575 • Cell (713) 539-0055
Houston, TX
710 McCarty Drive • Charlie McDaniel

See Our Inventory: www.amigotruck.com

2005 MACK CX613 VISION - E7 Mack 350 HP, 10 Speed, Camelback Suspension, 4.64 Ratio, 251" WB, All Steel Wheels, Tandem Axle, Double frame, NEW HydroVac, 3600 usg, D.O.T. 407/412, Hibon 820 blower 1400 cfm, hoist, full rear opening door, hydraulic vibrator, safety walkway, excellent truck. Call for Price



2001 MACK CH613 - E7 Mack 300 HP, 9 Spd OD, Air Ride Suspension, 4.64 Ratio, 262" WB, Aluminum/Steel Wheels, Tandem Axle, Double frame, New Cosco Aluminum Dump Commercial Vacuum, 4000usg, rear lifting door, MORO PM100 air cooled pump, 460CFM rating. Call for Price

"Heavy Duty Headquarters"

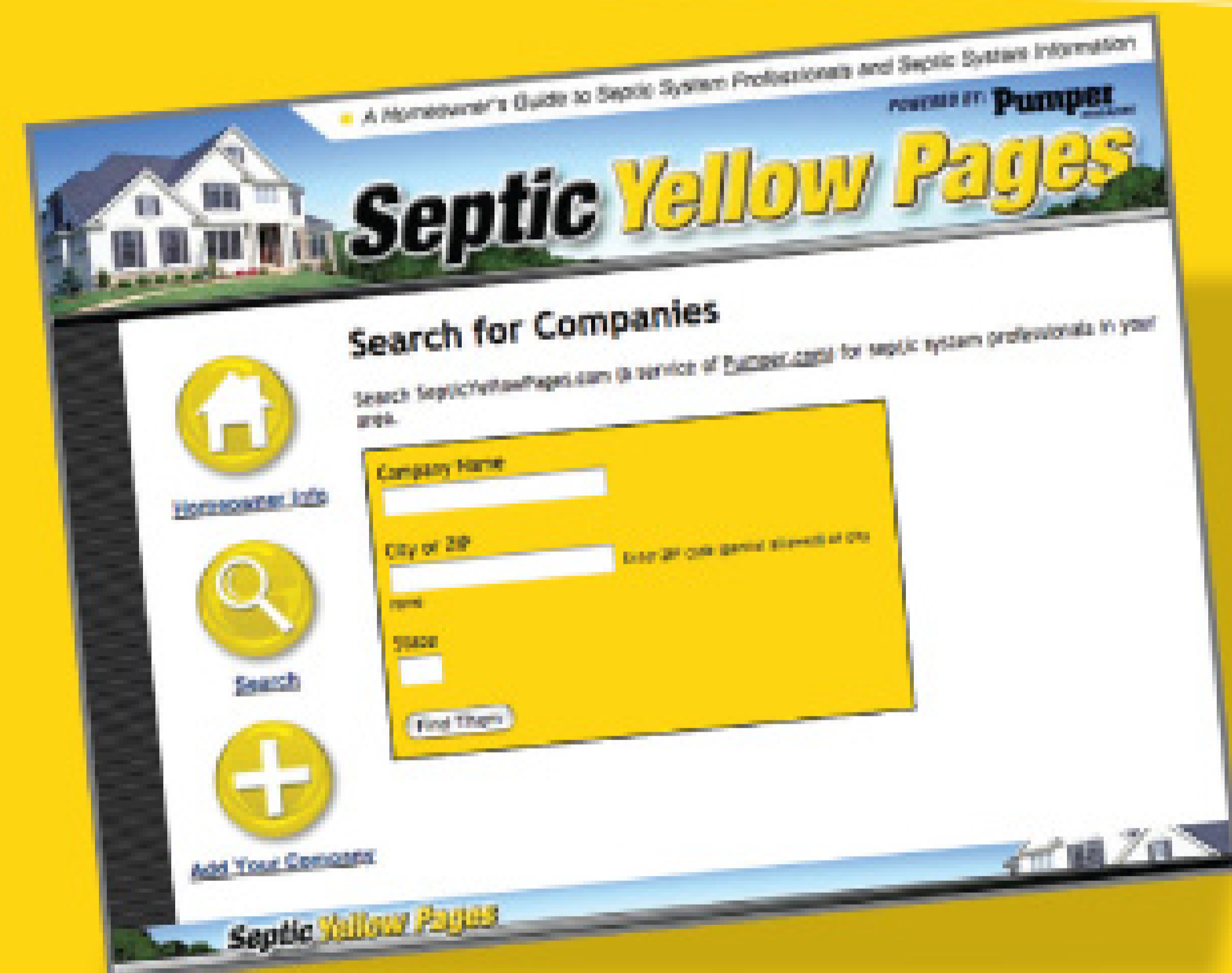

Listed on Septic Yellow Pages?

SepticYellowPages.com is a FREE service to qualified industry professionals who subscribe to Pumper Magazine. This web site helps homeowners find septic system professionals in their area.

Interested?
E-mail subs@pumper.com to get your company listed on septicyellowpages.com.



**Super Products
has included
ROOTS™ Vacuum
Blowers for over
35 years and now
it is getting even
better!**

Super Products has built a solid reputation for the quality and performance of its products. For over 35 years Super Products has relied on Dresser Roots to provide the vacuum blower at the heart of their product's high performance.



The Best Just Keeps Getting Better

ROOTS™ TRI-NADO® TM tri-lobe blowers have been re-designed to incorporate the latest technology for reduced noise and vibration. Roots patented tri-lobe technology in the early 1900s and has the longest track record for manufacturing rotary positive displacement blowers and exhausters. Before you settle for another brand, check out the new features on the New TRI-NADO TM. Contact us for more information or to locate your local distributor.



Roots

Toll Free: 1-877-363-7668
www.rootsblower.com

No Financials Required

Application Only to \$250K

No Age Restrictions

Used Equipment (30+yrs still ok)

Seasonal Payment Plans

- Bucket Machines
- Cable Machines
- Catch Basin Cleaners
- Combo Sewer Cleaners
- Dewatering/Composting
- Hydro Excavators
- Jetters
- Liquid Vacuum Trucks
- Trailer Mounted Combo
- Sweepers
- Vacuum Loaders
- and much more.....*

Working Capital

Start-Ups Welcome

Sale Leasebacks

Simple One Page Application

Private Party Sales

ACG IS A FULL IN-HOUSE LENDER. OUR TEAM OF PROFESSIONALS PROVIDE SAME-DAY DOCUMENTATION AND FUNDING. LET US STRUCTURE A PROGRAM THAT BEST FITS YOUR BUDGET WITH INSTANT CREDIT DECISIONS. LESS THAN PERFECT CREDIT (FICO 580+) IS APPROVABLE!



Bryan Joy 800-830-0084 x214

9436 Hamilton Dr. • Mentor, Ohio 44060 • Fax 800-830-9855 • www.1acg.com



4000 Gallon pumper on a 2007 M2 Freightliner

Tank: Bright finish aluminum-5/16" #5454 shell and heads 76" Dia.

Pumping system: Jurop LC420 water cooled pump

Chassis: Freightliner M2-54,000 GVW, C-7 Caterpillar 300 H.P., 10 speed transmission-14,600 front axle-40,000 air ride rear axle.

2800 Gallon pumper on a 2007 International

Tank: Bright finish aluminum-5/16" #5454 shell and heads

Pumping system: Massport HXL 15 (350 CFM)

Chassis: International 4300-33,000 GVW, 245 HP DT466-RDS 3500-12,000 front axle, 21,000 rear axle.



WHITE RIVER
DISTRIBUTORS, INC.
BATESVILLE, ARKANSAS

(800)-548-7219
(870)-793-2374
www.lpgbobtails.com

e-newsletter

Have you seen the latest
monthly e-newsletter
of **Pumper?**

If not, go to:
www.pumper.com/enews



Our **VALUE** goes deeper than you realize.

When it comes to portable sanitation solutions, WALEX delivers much more than blue deodorizers and accessories. We're giving you **innovative research & development** that has set all the current standards for excellence. You're getting **proprietary breakthroughs** that our competitors can only emulate. When you choose WALEX, you're not only getting **the best on the market today** — *you're also supporting your industry's future.*



Thanks for visiting us!



For more information, contact us at 910.371.2242, toll-free 800.338.3155
or visit our website at www.walex.com.



NAWT BOARD OF DIRECTORS:

Hollis Warren, President, DE
Tom Frank, Vice President, OH
Bruce Fox, Past President, PA
Mitch Okerstrom, Treasurer, MN
Tom Ferrero, Secretary, PA
Jim Anderson, MN
Mark Hacker, IN

Tim Frank, OH
Bill Hall, CT
Wayne Hudson, DE
Darlene Johnson, NH
Bob Kendall, WI
Frank King, MA

Ralph Macchio, NY
Lee Orton, NE
Richard Sinclair, AZ
Jeff Snowden, TX
Carl Stenberg, MI
Roger Winter, Ontario

NAWT EXECUTIVE DIRECTOR: A. Thomas Ferrero, Jr.

NAWT Training Benefits Pumpers and the Environment

By Tom Ferrero

BASIC AND INSPECTOR TRAINING

Besides acting as the industry's voice at the national level, the purpose of the National Association of Wastewater Transporters Inc. is to disseminate information and act as a communication and education conduit.

Consequently, NAWT developed a national certification program for inspecting onsite systems, incorporating the five management levels proposed by the U.S. Environmental Protection Agency. Over the past four years, more than 2,000 inspectors have passed the examination and more than 1,100 are registered on NAWT's Web site.

As part of the project, NAWT trainers conducted "train the trainer" sessions in California, Texas and Iowa. The NAWT approach is used for continuing education programs in Arizona, Delaware, Ohio and New Mexico.

The NAWT onsite inspection course is at the operation level. It requires attendees to locate and identify all parts of the system, assess their condition, and determine if they are operating properly. Septic tanks, pump chambers, pretreatment media filters, aerobic and soil treatment units must be accessible and opened. Graduates must complete eight hours of continuing education every two years to maintain their certification.

OVER THE PAST FOUR YEARS, MORE THAN 2,000 INSPECTORS HAVE PASSED THE EXAMINATION AND MORE THAN 1,100 ARE REGISTERED ON NAWT'S WEB SITE.

OPERATION AND MAINTENANCE, PARTS 1 AND 2

As a member of the Consortium of Institutes for Decentralized Wastewater Treatment, or CIDWT, NAWT participates in developing standard educational materials that can be used nationwide. To date, the organization has written a University and Practitioner onsite wastewater treatment curriculum, and a comprehensive manual and training material on Operation and Maintenance. They also conducted train-the-trainer sessions on developing training courses and the use of the materials.

CIDWT training is conducted over four days, but NAWT's Board of Directors felt it was impractical for pumpers to be away from their businesses for that long. They also felt that it was important to incorporate field and hands-on experiences. Therefore, the training was split into two, two-day sessions. The first session covers operating and maintaining septic tanks, trenches, beds, mounds and at-grades. The second session covers aerobic tanks, single pass and re-circulating media filters. Both have in-the-field opportunities and an exam. Certified service providers will be listed at www.nawt.org.

VACUUM TRUCK TECHNICIAN TRAINING

This one-day course is for new owners and employees who operate vacuum trucks to clean septic tanks, aerobic treatment units, holding tanks or grease traps. It can also serve as a refresher course and overview for experienced operators. Training is done through presentations, videos, and hands-

on training using a vacuum truck. The Pennsylvania Septage Management Association developed a train-the-trainer program so the course can be presented in your state or company. Vacuum truck technician training includes:

- Basic pump truck operation
- Materials to pump and avoid
- Reasons to manage these materials
- Pumps
- Basic science of vacuum and pressurization
- Truck equipment and components
- Drive and control mechanisms
- Basic and advanced pump-out skills and procedures
- Loading and unloading
- Safety and emergency response plans
- Customer interaction and education
- Manifests and reports
- Government regulations

ONSITE INSTALLER PROFESSIONAL TRAINING

This one-day course provides training and an exam to prepare for the National Environmental Health Association Certified Installer of Onsite Wastewater Treatment Systems credential exam. Topics covered are:

- Planning and site evaluation
- Installing sewage tanks
- Installing below ground systems
- Installing above ground systems
- Installing pumps and pump stations
- Installing media filters

To bring NAWT-sponsored training courses to your area, contact Tom Ferrero, NAWT executive director, at 336 Chestnut Lane, Ambler, Pa. 19002-1001, 800/236-6298 or e-mail tom@ferrero.bz.

3RD ANNUAL WASTE TREATMENT SYMPOSIUM

It's time to finalize plans to attend the third annual Waste Treatment Symposium Sept. 10-11 at the Holiday Inn in Eureka, Mo. Call 636/938-6661 for room reservations and mention NAWT to receive our discounted rate. Topics include:

Day 1 (classroom)

Case histories
Description of the treatment process
Treatment alternatives
Economics of treatment
Dewatering operations
Belt filter press
Container filter
Rotary vacuum filter
Other treatment processes
Social hour for networking

Day 2 (in-the-field)

Tour of septage treatment facility
Septage conditioning (polymers)
Screening and grit removal
Hands-on dewatering equipment
Belt filter press
Container filter
Rotary vacuum filter
Other treatment processes
Peripheral equipment
(Lunch included both days)

Attendees will learn to evaluate available resources and match them to the necessary unit processes to economically and operationally develop a successful waste treatment facility. Presenters are industry leaders with firsthand experience. Vendors will give presentations about their equipment. A field trip to a septage treatment facility will introduce participants to equipment working with septage, grease trap waste and sewage sludge. The event offers a hands-on opportunity for those with disposal issues wanting to take control of their destiny. To register for the course, call NAWT at 800/236-6298 or download the application form at www.nawt.org.

RENEWING INSPECTION CERTIFICATION

Certification is good for two years. Professionals may submit CEU documentation any time during that period, but the certification is renewed only at the anniversary date. NAWT's inspection program requires eight educational hours, basically one day of training on inspection or related onsite subjects. However, the training must occur at least six months after the certification or renewal date. NAWT's Education Committee approves certificates received in onsite system inspections, installations, design, or operation and maintenance. It does not count hours related to municipal treatment plants, business or marketing.

SUMMARY OF NAWT RECERTIFICATION REQUIREMENTS

Renew only at your anniversary date.

Pumpers must wait six months after certification or recertification before accumulating continuing education credits. Pumpers must verify attendance through certificates or other official documents. Three representatives from the education committee will review requests for approval. Please submit them before the event to learn if they count for continuing education credits. Generally, sessions count as long as they pertain to onsite systems. Proprietary and business courses do not qualify.

THE RIGHT TOOLS FOR THE JOB

What's the most important tool you have? Your **PUMPER**, of course.

What's the second-most important? Your **PHONE**. This may not be the tool you always think of as second-most important, but without it you're not in business.

What other tools do you need? In order of appearance:

1. **Locator** or **probe** to locate lines and tank;
2. **Shovel** to dig it up;
3. **Pry bar** to uncover it.

Now it's time for the pumper. After the tank is empty what's next? Let's restore some drainage:

4. **Camera** to identify problems;
5. **Jetter** to remove buildup from lines; and/or
6. **Terralift** to fracture the soil.

Now the tank is empty, the lines are free of buildup, and the soil has new drainage pores. You've removed solid material from every area you can get to with your equipment. Anything else needed in your toolbox? **YES!**

7. **Bacteria** to get to the places you can't reach with your equipment (called bioremediation).

The billions and billions of beneficial bacteria in our **BIO-REM E-D** (pronounced Bio-Remedy) will follow the percolation you've created with your jetter and digest the buildup in the gravel and soil—places you can't get to with your jetter. The best 1-2 punch there is!

And the billions and billions of friendly microorganisms in **BIO-REM E-D** will follow the soil fractures you've created with your Terralift and really blow it open. Guarantee your Terralift work with confidence.

BIO-REM E-D is a unique scientific blend of the exact-right organisms to digest and remove the organic solids generated by residential and commercial waste. **BIO-REM E-D** will digest 95% of the organic material that goes down the residential drain (and the other 5% shouldn't go down the drain). It will also digest the grease, fat, oil, and other food waste generated in the commercial kitchen. **BIO-REM E-D** is a USDA-Authorized, foodgrade product. It has been used in problem residential drain fields and commercial grease waste systems in all 50 states and Canada since 1981.

Please pick up your second-most important tool and call us toll-free at 1-800-759-2257. Give us the opportunity to show you these exciting programs designed to complete the jobs of all your other tools. The call is free, and there is no obligation or fee. Put **BIO-REM E-D** in YOUR toolbox! Your customers and your bank account will thank you. Please call today.

Thank you.
Rick Howe, President



Partners with Septic Contractors Since 1976

CAPE COD BIOCHEMICAL COMPANY

P.O. Box 990 • Pocasset, MA 02559



1-800-759-CCLS

(1-800-759-2257)

FAX: 508-564-9974

www.SepticOnline.com



Double Conical Vacuum Trailers **vacutrux**



**Improved handling
for high sludge volumes**

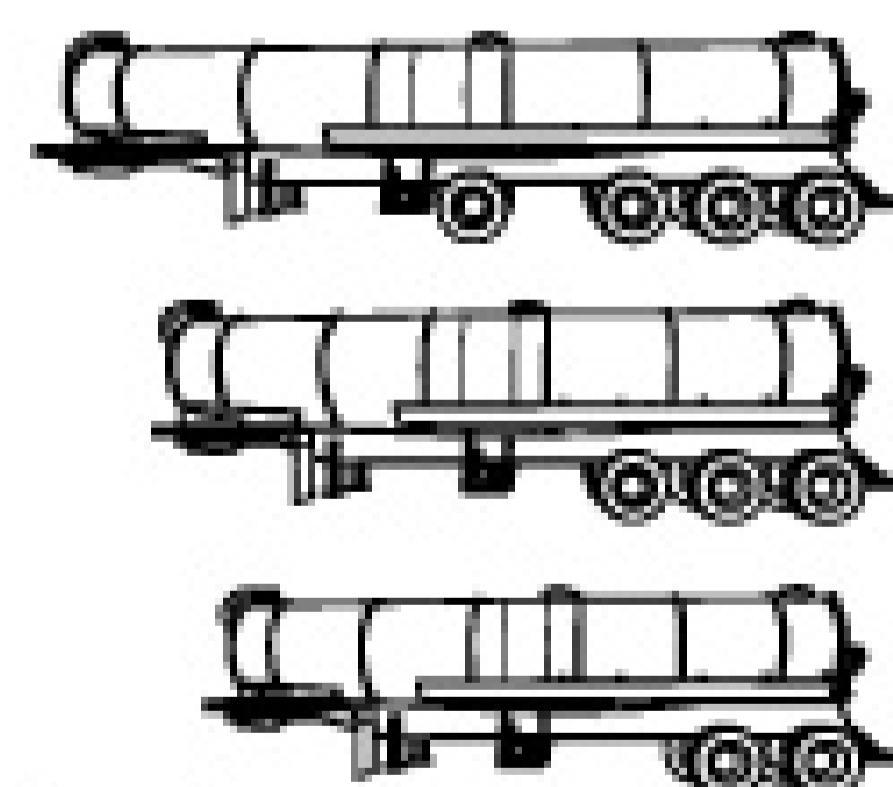
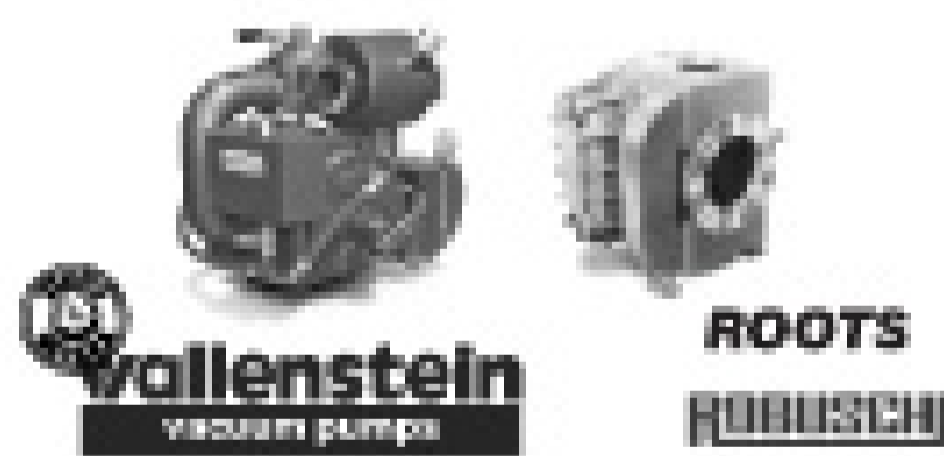

Trailer sized for your requirement.
Powerful vacuum pumps.
Superior suspension and trailer technology!

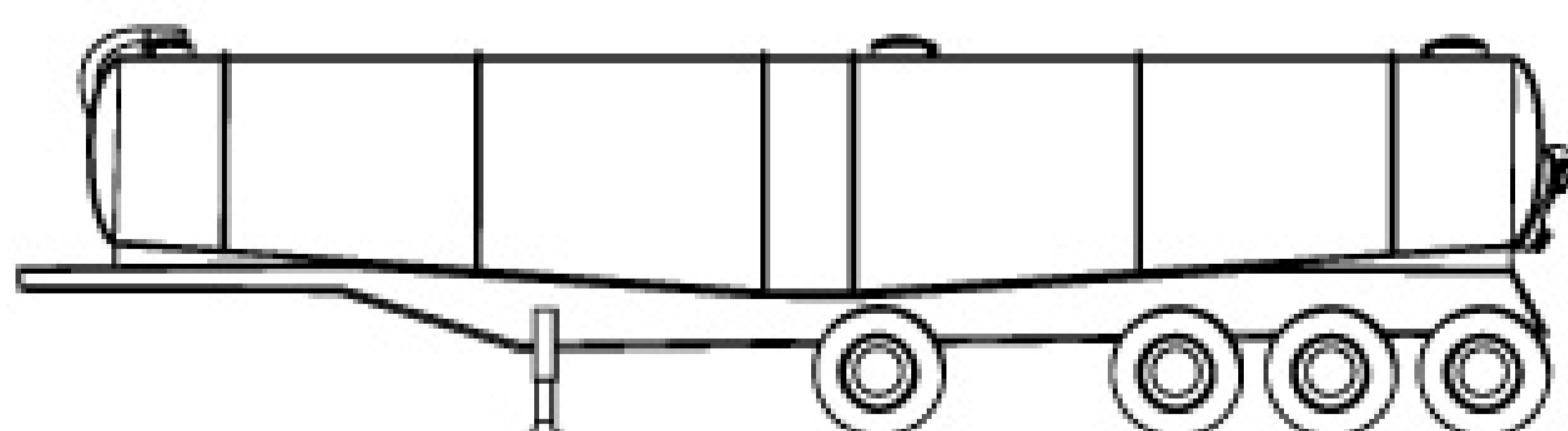

Vacutrux Limited 53 Arthur Street N. Elmira,
Ontario, CANADA N3B 2Z7 800-305-4305 Fax:(519) 669-8331

T&T TOOLS

T&T TOOLS, Inc.

FAX: 800.521.3260 | EMAIL: sales@TandTtools.com

800.521.6893

www.TandTtools.com

CALL FOR A FREE CATALOG!

CALL FOR A FREE CATALOG!

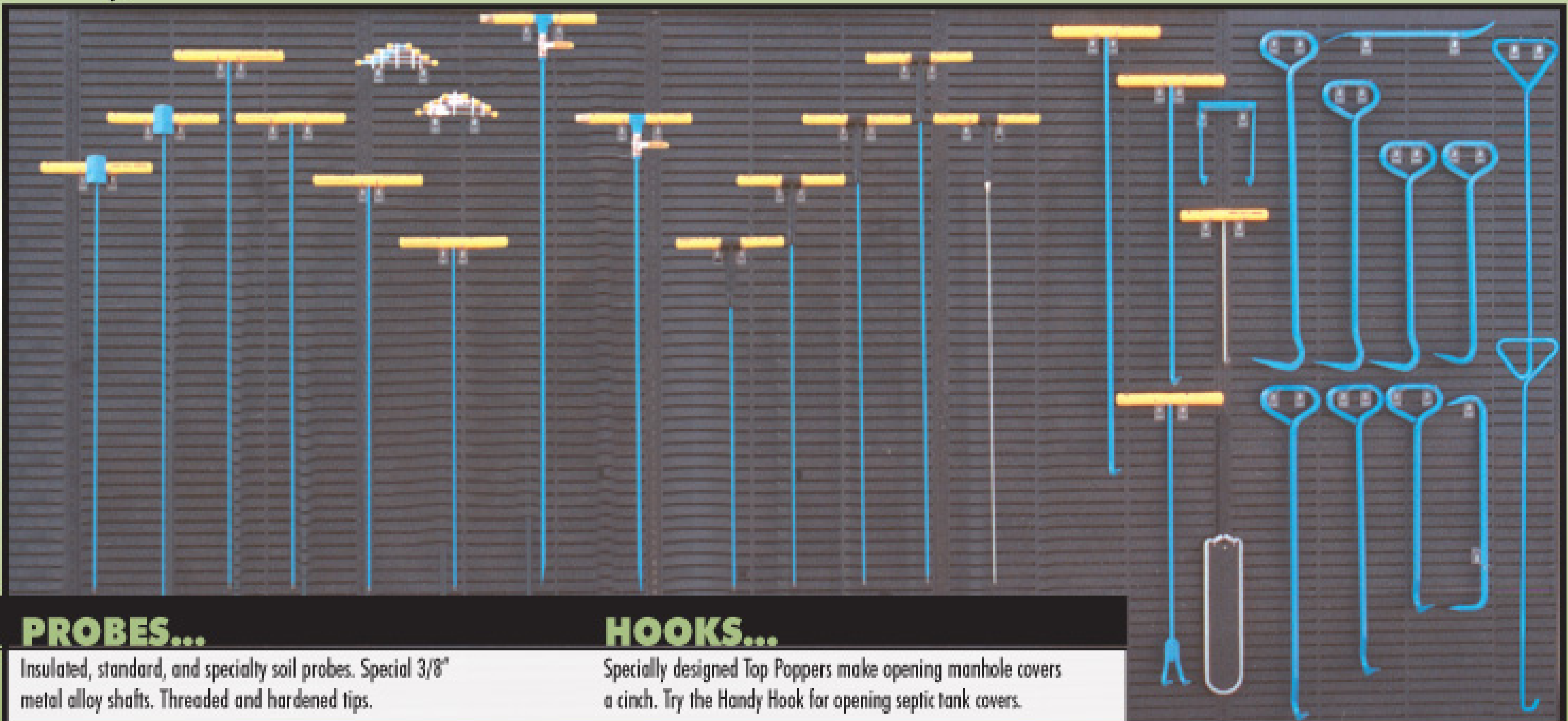

PROBES...

Insulated, standard, and specialty soil probes. Special 3/8" metal alloy shafts. Threaded and hardened tips.

HOOKS...

Specially designed Top Poppers make opening manhole covers a cinch. Try the Handy Hook for opening septic tank covers.

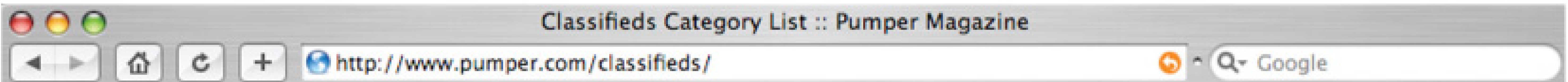

WWW.ONSITEINSTALLER.COM | WWW.PROMONTHLY.COM | WWW.CLEANER.COM | WWW.MSWMAG.COM | WWW.PUMPERTRADER.COM | WWW.PUMPERSHOW.COM

Pumper

SUBSCRIBE

EDITORIAL

CLASSIFIEDS

VIDEO

ADVERTISING

Looking to **BUY** or **SELL**?
Just Submit Your Classified Ad **ONLINE!**

Only
\$1.00
PER WORD
(\$20 Min.)



It's Easy & Secure!

Your ad will be posted on the *Pumper* Web site within two to three business days after received.

Just go to www.pumper.com; click on "Classifieds;" click on "Place a Classified Ad;" fill in the online form.

**YOUR CHOICE OF:
STEEL, ALUMINUM OR
STAINLESS TANKS!**



**IMPERIAL
INDUSTRIES INC.
800-558-2945**

**WE DIDN'T JUST INHERIT THE NAME "IMPERIAL",
WE EARNED IT WITH "IMPERIAL" QUALITY/DESIGN/SERVICE**

**CUSTOM MANUFACTURED PARTS/REPLACEMENT PARTS • VACUUM PUMP SALES & SERVICE
"24" HOUR ON-LINE PARTS SHOPPING**



\$130,930⁰⁰ W/FET

3600 Gallon Steel Unit

Call [Jim Stieber](#) or [Brad Rybarczyk](#) for details!

**PORTABLE TOILET SERVICE UNITS, BOTH STEEL AND ALUMINUM
IN STOCK AND READY TO SHIP AT ALL TIMES!**

STOCK UNITS

- 875 Gallon Steel Tank 300/575
- 1100 Gallon Aluminum Tank 400/700
- 2150 Gallon Aluminum Tank 550/1600



V&H AUTOMOTIVE
Marshfield, WI 54449
Randy Tischendorf

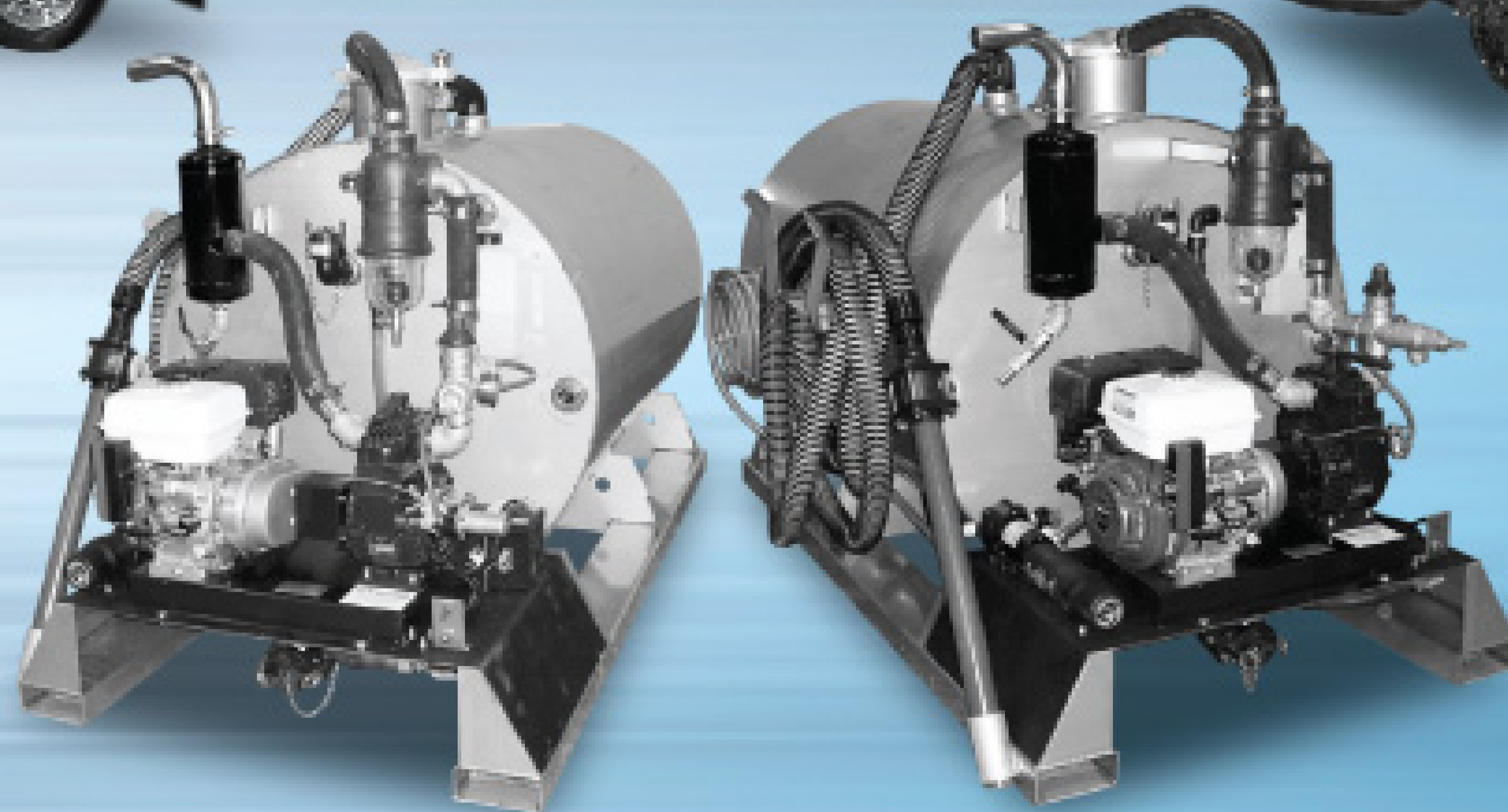

IMPERIAL
P.O. Box 1685 • Wausau, WI 54402
Tom Aerts

800-722-7382, ext. 244

www.imperialind.com

800-558-2945, ext.317

We Need to Fix What?

How do you convince cost-conscious customers to move forward with necessary septic tank repairs?

By Mary Shafer

Everyone's had the experience: You're performing a routine pumping operation, when you discover a problem. Maybe a septic tank baffle has collapsed, or there's a crack in the tank. Right now, no big deal, but you foresee big trouble in the near future. So you tell your customer, and suggest the necessary repairs. The customer requests a quote, and when you render the estimate, he or she backpedals so fast you can feel the breeze.

What do you do in this potentially disastrous scenario? You sympathize with a customer facing a surprise repair bill, and some of them really aren't prepared to spend the needed money. But if the repair isn't made, very bad things are going to happen. You don't want to get blamed for negligent service when the stuff does finally hit the fan — maybe literally. Regulations also play a part in how these situations must be handled, depending on your location.

Approaching such a situation requires a combination of sound business ethics, good people skills, and sometimes the ability to be a little creative in the finance department. The key is understanding that you bring the most value to your customer when you act as a partner in solving their problems. Recognize the public relations opportunity presented by the situation, and provide positive options for them to deal with their dilemmas. Many times, they're as afraid of making the wrong decision as they are with making large, unexpected expenditures.

The trick is moving them from a bad decision to a good one. Here, four pumpers share their tactics for dealing with intransigent tank owners who simply want to ignore needed repairs.

"I'd say 25 percent of our customers go ahead with recommended service immediately after we identify the problem," says Jerry Thompson, former owner and now business advisor to Woody's Septic Tank Service. The rest will stall for time, so the company protects itself by writing the problem



Name: Jerry Thompson, Business Advisor
Company: Woody's Septic Tank Service
Location: Daytona Beach, Fla.
Employees: 25
Years in Business: 55

Jerry Thompson

Bonus

PIPELINES PLUS:

It's difficult to move an intransigent customer toward doing the right thing, but there are proven methods of helping someone see your side of the story. An article on the Internet may help you learn a few pointers about successful persuasion. Check out "How to Persuade and Influence People" at <http://tinyurl.com/2pnmrx>. Author Wolf J. Rinke is a motivational and management keynote speaker, seminar leader, management consultant, and executive coach. He offers some sound advice on helping people see your point of view.

Comments may be directed to Mary Shafer in care of Pumper. You may also e-mail pipelines@pumper.com.

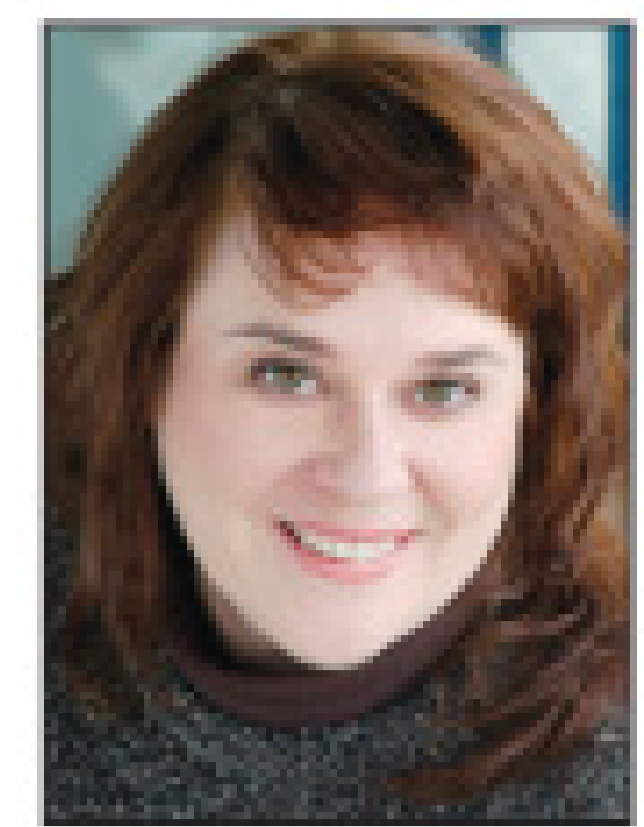

"I'd say 25 percent of our customers go ahead with recommended service immediately after we identify the problem ... It can come back on you if the system fails soon after service. But we have a record of our recommendations."

Jerry Thompson

clearly on the job invoice and on the pump-out ticket, along with service recommendations. The customer gets a copy along with the bill. "It can come back on you if the system fails soon after service. But we have a record of our recommendations" to guard against customers saying they were unaware of issues, says Thompson.

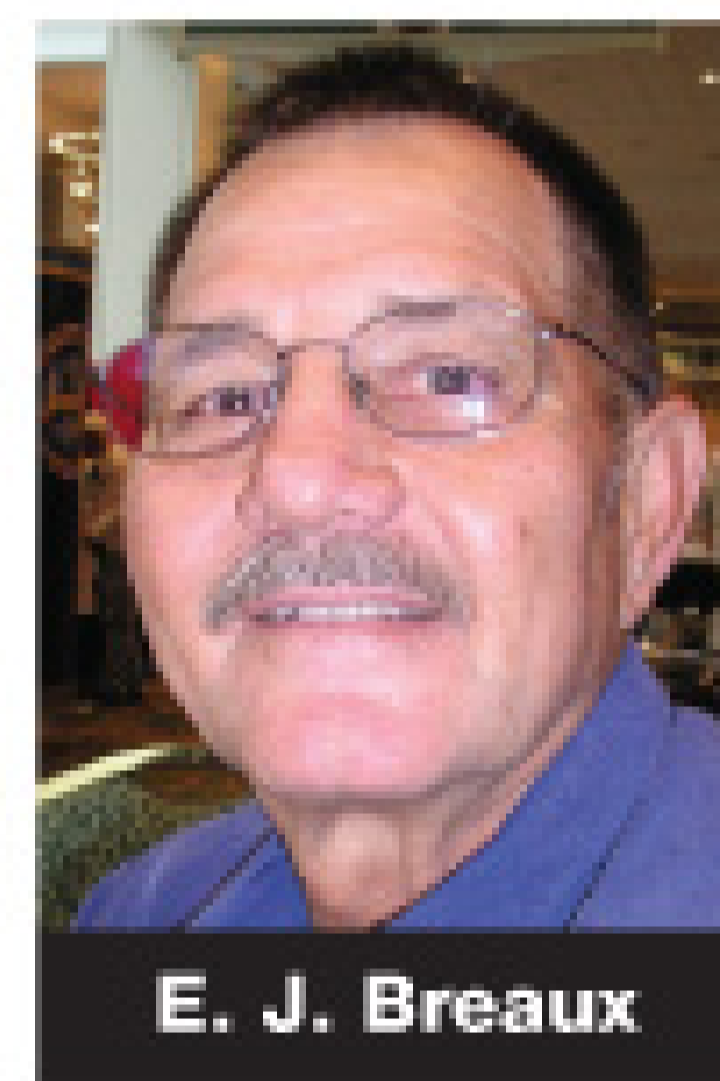

Name: E. J. Breaux, Owner
Company: E. J. Breaux Wastewater Treatment Systems
Location: Pierre Port, La.
Employees: 5
Years in Business: 25

E. J. Breaux

E. J. Breaux, along with pumping, installs about 350 septic systems a year in an area northeast of Baton Rouge. About 75 percent of his business is residential, where he specializes in package aerobic systems for any location using more than 3,000 gallons per day. He also services some commercial applications, including truck stops with extended systems that process up to 30,000 gallons daily.

When he encounters a home or business owner reluctant to perform needed repairs, it's not a matter of his personal discretion: Louisiana state regulations require paperwork. "We have to issue a report saying they refused repair," Breaux explains. If the customer does agree, Breaux will perform some of the repairs himself, and subcontracts others if they're too involved or time-consuming.

Donald Foster has managed to engender enough trust and confidence among his regular customers that he rarely encounters trouble when he tells them they need to make repairs. They understand that "we recommend repairs be done for their benefit," Foster says. "Most of the time, they'll follow our recommendations, if they can afford it." Foster doesn't do the work himself, which may account for the stronger credibility, since customers aren't likely to think he's simply trying to churn up more work for himself. He has a couple colleagues he'll regularly refer repair work to.

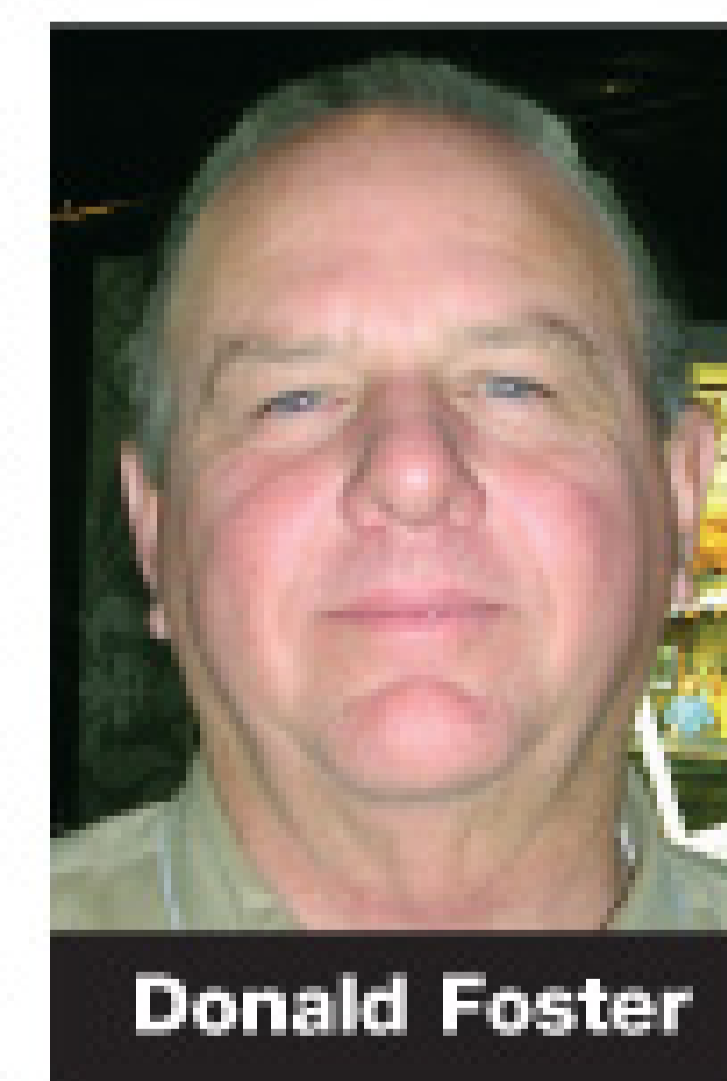

Name: Donald Foster, Owner
Company: Foster Septic Tank Cleaning
Location: Henderson, N.C.
Employees: 5
Years in Business: 31

Donald Foster



Name:
Larry Favreau,
Owner
Company:
L.R. Favreau
Septic Service LLC
Location:
Sterling, Mass.
Employees: **2**
Years in
Business: **18**

Larry Favreau installs, inspects and pumps septic systems in central Massachusetts, just north of Worcester. His service area includes about 30 towns in Worcester County. When he finds a problem in a tank, he explains to the customer in detail what should be repaired and why. "I'll also tell them what

will happen if they decide not to repair, and there are very few people who don't want to have it done then." If the customer opts to have the repair done, Favreau schedules another appointment and comes back later to perform the repair. Sometimes, with big system failures, he'll first perform a camera inspection.

In such a case, Favreau will set up a contract for people with massive system failures who are facing large repair or replacement costs. "It makes it easier for them to handle payments, and helps them to make the right decision."

When customers refuse to make a needed repair, Favreau protects himself with paperwork. "It's up to them. I don't like to get involved in people's finances. But they're going to know what I think they should do, and they're getting it in writing." ■

"I don't like to get involved in people's finances. But they're going to know what I think they should do, and they're going to get it in writing."

Larry Favreau

Custom Built YOUR Truck or Pull-type Chassis or OURS



- Septic Systems
- Municipal Waste Control
- Ag Operations
- Supplier for Brass or Stainless Steel Gate Valves
- Vacuum Pumps of All Sizes

Call Kevien Schroeder Today! 1-800-795-8551 ext. 124

Vertical Electric Pump

Agitate, transfer or top fill hauling units. Choose from standard lengths of 4' - 6' - 8' - 10' - 12', other sizes available upon request



Galvanized Construction!

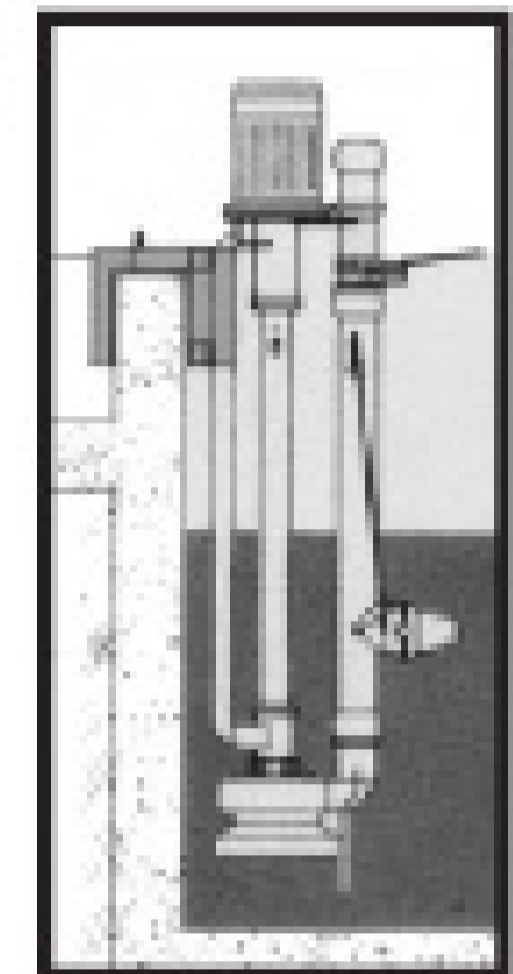

BALZER INC.

STEWARDS FOR  ENVIRONMENTS

CO. RD. 27, Box 458
Mountain Lake, MN 56159
1-800-795-8551
www.balzerinc.com



Super Products

Worldwide Vacuum Technology - Since 1972



Thank you for visiting us at the show

Supersucker® with High-Dump Option

- › Rear Lift Height up to 60"
- › Unloads Efficiently
- › Heavy Duty
- › Low Maintenance
- › Easy to Operate



www.superproductscorp.com

800.837.9711

Get More Income with Every Tank Pumped!

With

PRO-PUMP®

The Finest Name in Biological Products for Septic Systems, System Recovery, Odor Elimination and More...

Introducing New PRO-PUMP/SEPTIC SAVER!



SEPTIC SAVER

PRO-PUMP/SEPTIC SAVER is a combo pack of our two best selling septic treatments: PRO-PUMP/HC & SP packets, bundle packed as a monthly (12) treatment program.

- Septic System Treatment
- Absorption System Recovery
- Aerobic System Treatment
- Drain & Grease Traps
- Solids Reduction
- Odor Control
- Bio-remediation

The Best Microbial Technology Available Today!

The PRO-PUMP® biological series is designed to meet a wide range of on-site wastewater applications with unmatched performance!

Want to earn more income per truck per year?
BECOME A PRO-PUMP® DISTRIBUTOR!

Professional Sales Materials & Technical Support at No Charge!

We provide technical support, combined with informative sales and marketing materials, and we don't sell direct to the consumer! All web-based inquiries are sent to you!



Solving Problems, Naturally!

Ecological Laboratories INC.

CORPORATE OFFICES: 13 Hendrickson Ave., Lynbrook, NY 11563

TOLL FREE: 1-800-326-7867 • FAX: 516-823-3440 • EMAIL: info@propump.com

Visit our web site at: www.propump.com

TRUCK TOWN

2601 East Hwy. 80 • Abilene, Texas 79601

FULL SERVICE VACUUM SYSTEMS SUPPLIER



1-800-727-0350

GOOD ASSORTMENT OF CUSTOM SPEC TRUCKS FOR YOUR VACUUM UNIT NEEDS

LELY SEPTIC & OIL FIELD VACUUM TRUCKS
TROXELL TRAILERS



JEFF MULLICAN • HUBERT YOUNG • DENNIS ADAMS

Phone: 325-673-4642 • Fax: 325-673-4673

Web Site: www.truck-town.com • E-mail: truck@camalott.com

ONSITE installer™



FREE To Qualified Industry Professionals!

Go to www.onsiteinstaller.com to qualify for your free subscription.

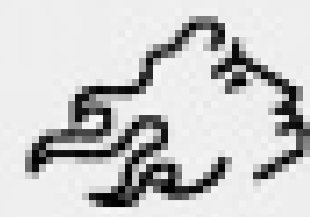

Placing a value on what you've built.

A knowledgeable buyer can make all the difference.

We own a portable restroom business in Southern California and are actively looking for potential acquisitions across the U.S. So if you have built a quality business in the portable sanitation industry, we would like to meet with you.

At Prometheus, we specialize in acquiring profitable, middle market companies in route businesses.



And we are especially focused on the portable sanitation industry. Here's why you should contact us:

CAPITAL

Whether you are looking to sell your business or are looking to grow, you need capital. We are a cash buyer and can complete a transaction quickly.



Also, our relationships within the financial community provide access to additional sources of capital necessary to grow

your business. If you are interested in selling a portion or all of your business or if you believe a committed equity partner can help you achieve the vision you have for your business, we would look forward to meeting with you.

Nicholas Peters
President and CEO

Chris Suh
Director

Chris Russell
Principal



PROMETHEUS

Product News

PRODUCT SPOTLIGHT

Higher fuel prices hit liquid waste haulers right where it hurts — on the bottom line. They're also finding it increasingly difficult to dispose of materials such as waste oil from frying grease.

Fergus Power Products tackles both issues with the SSI-250 Biodiesel Processor, which converts used fryer grease — or even virgin oil — into diesel fuel for about \$1 cheaper per gallon than the cost of commercial fuel (under current prices).

"You can make biodiesel fuel for \$2 to \$2.50 a gallon, depending on whether you use virgin oil or used oil, your local electricity rates and other factors," explains Jim Peterson, sales manager for Fergus Products. "This product is aimed at mom-and-pop outfits all the way to large corporations. Everyone is interested in an environmentally safe product that you can use in your vehicles, as well as reducing disposal costs."

The stainless-steel, electric-powered processor consists of three tanks mounted on a custom-built, stainless-steel skid. The processor is available in three sizes: 50-, 100- and 250-gallon capacities. Using a 100-gallon unit as an example, an

operator fills a tank with 100 gallons of used or virgin oil, 10 gallons of racing fuel (methanol), and small amounts of lye (sodium hydroxide) and 93 percent pure sulfuric acid. Each unit comes with measuring cups, and it takes about an hour to add in all the "ingredients," Peterson says.

The operator turns on the unit, which proceeds to pull the animal fats and proteins from the oil, producing glycerin. After



SSI-250 Biodiesel Processor from Fergus Power Products

that, the operator adds a granular silicone product, and during a subsequent wash cycle, a chemical reaction converts the waste oil into biodiesel fuel. The whole

Biodiesel Processor Turns Waste Oil into Fuel

By Ken Wysocky

"This product is aimed at mom-and-pop outfits all the way to large corporations. Everyone is interested in an environmentally safe product that you can use in your vehicles, as well as reducing disposal costs."

Jim Peterson

process takes about 24 hours, regardless of the unit's size, Peterson notes.

Aside from the need to occasionally oil the motor, the units are basically maintenance-free, Peterson adds.

"The processor cleans itself during the process," he explains.

The smallest unit has a footprint of about 4 feet by 4 feet, and the largest unit occupies about a 4- by 6-foot area. Each unit can be moved with pallet jacks, Peterson notes.

Currently, grease from grease traps cannot be used in the processors; it must be heated and filtered. But Fergus is working to develop a way to do that easily and cost effectively, Peterson points out.

For more information, visit www.ferguspowerproducts.com or call 218/736-6772.

Zoeller Introduces Pre-Assembled Package System

The Simplex 912 from Zoeller Pump Co. is a 24-inch by 24-inch, pre-assembled package system with 41-gallon capacity. The 360-degree molded handle acts as a secondary anti-flotation device, while flat areas allow for additional field installed inlets. Cover connections are threaded for vent and discharge piping. The unit is available with pump model 211 and cast-iron construction models 264 and 266. For more information: 800/928-7867; www.zoeller.com.



Simplex 912 from Zoeller Pump Co.

Signature Fencing Designs DuraDeck Ground Protection

DuraDeck from Signature Fencing & Flooring Systems offers heavy-duty ground protection. The portable, 4-foot by 8-foot roadway mats are made of 1/2-inch recycled polyethylene plastic and support vehicles up to 60 tons. The mats can be connected to form a continuous, solid roadway or platform of nearly any size, and feature a traction design on both sides. For more information: 212/953-1116; www.signaturefencing.com.

Armal Presents Pre-Scented Restrooms

The Scentbox portable restroom from Armal features long-lasting, fragrance-scented walls, and is available in five scent-matched colors.

For more information: 866/873-7796; www.armal.biz.



Scentbox from Armal

ADS Presents ARC 36 Leaching Chamber

Made of high density polyethylene, the ARC 36 leaching chamber from Advanced Drainage Systems Inc. features a 20-degree integral articulating joint for either straight or contoured applications. The corrugated chamber design eliminates flat surfaces and provides increased load-bearing capacity. The joint also incorporates a modified post and dome design for added strength. Available in 5-foot lengths, it offers a universal inlet/outlet cap with knockout inspection vent ports on every unit. For more information: 800/821-6710; www.ads-pipe.com.

Ace Supply Offers Mobile Vac Boom

Designed for hydro-excavating or vac-excavating, the Mobile Vac Boom flex-hose extension from Ace Supply attaches to a mini-excavator, excavator, skid-steer or backhoe, providing greater safety and more precise excavation. For more information: 814/899-3644; www.mobilevacboom.com.



Mobile Vac Boom from Ace Supply

EZTrakR Offers Inventory Tracking Technology

EZTrakR data system combines PulseStar and iButtons technology to track employee productivity, adjust service routes, record inventory and provide one-touch billing. Attached to each restroom unit, ID data from the metal iButtons can be scanned with a reader, updating customer accounts with the date and time of each service, as well as yard inventory and deliveries. For more information: 866/529-1938; www.eztrakr.com.

Clear Computing Launches Centralized Reporting

Clear Computing has added centralized financial reporting for external divisions to its Total Activity Control operations management system. The new feature enables users to access and run individual or combined reports, wherever they are located. Reports can be viewed, e-mailed or exported into Excel. For more information: 888/332-5327; www.clearcomputing.com.

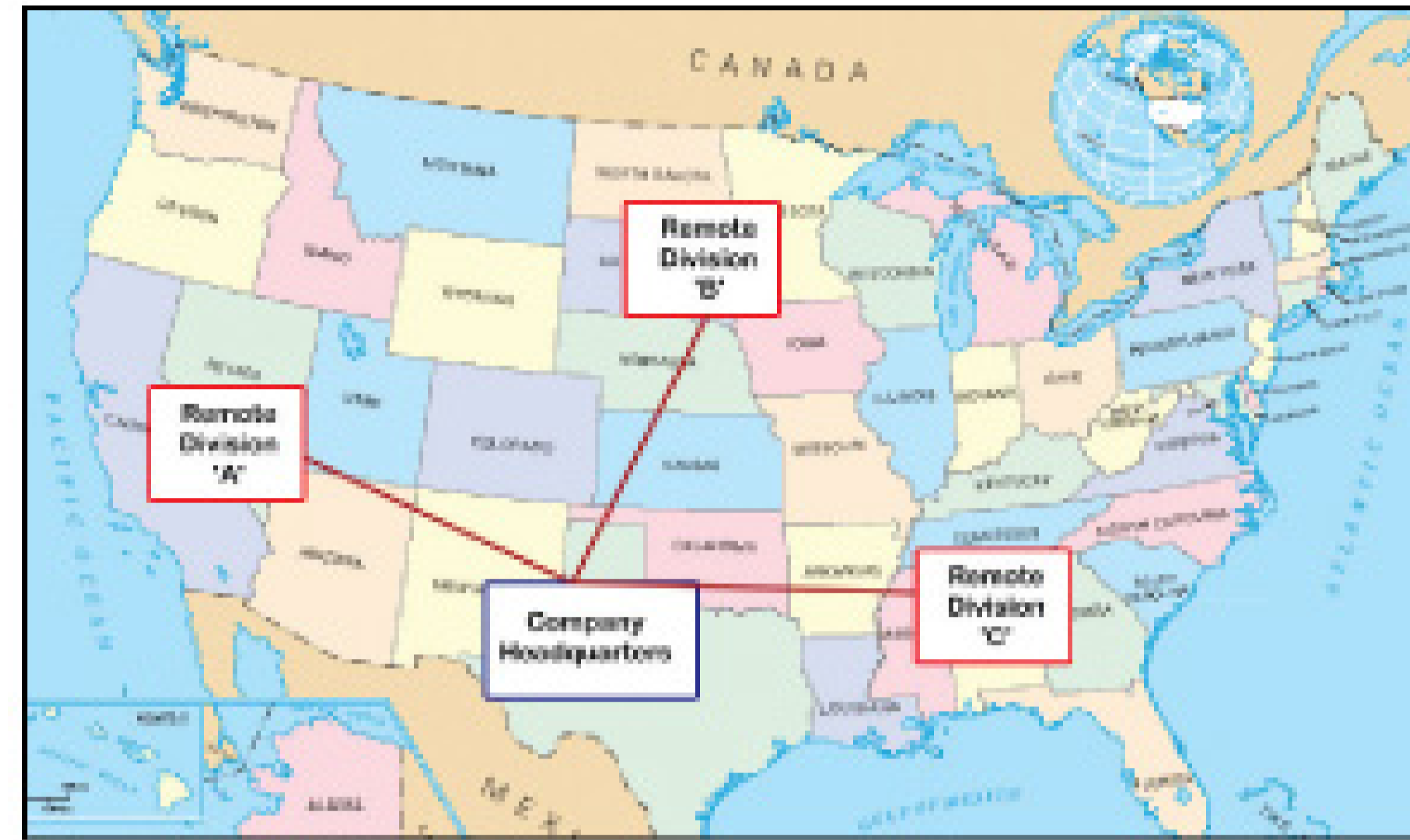

Total Activity Control from Clear Computing

Water Cannon Designs Undercarriage Attachment

The Mud Cannon undercarriage cleaner from Water Cannon attaches to a pressure washer hose and requires only 5 1/2 inches of clearance. Featuring a stainless-steel Mosmatic swivel and spray bar, the spinning 4-nozzle rotating assembly cleans an approximately 24-inch area. The unit has a telescoping handle and can withstand temperatures up to 195 degrees F, as well as almost any type of liquid chemical or acid solution. For more information: 800/333-9274; www.watercannon.com.



Mud Cannon undercarriage cleaner from Water Cannon

Ameri-Can Designs Race-Team Shower Trailer

Ameri-Can Engineering is celebrating its 20th anniversary with the launch of its race-team shower trailer. The trailer contains both shower and restroom features, power generation capability and storage for additional equipment. The units can be customized with a full exterior wrap, displaying team sponsors and logos. For more information: 574/892-5151; www.ameri-can.com. ■

Go With the Flow

For the most accurate picture of sewage treatment capacity in a home, you have to crunch some numbers and make good guesses

By Roger E. Machmeier, Ph.D.

Q Any time the term “gallons per day,” or gpd is used, I wonder if it is referring to design or real gpd. New Hampshire stipulates a capacity of 150 gpd per bedroom, and most understand that this is a “peaked” design figure. If we have real metered water flows to design from, we will at least double this number for design. Maine uses a more realistic 90 gpd per bedroom. Other states have their own numbers. The 150 seems a common figure.

A Your letter and comments raise some interesting points. You refer to a “design or real gpd” (gallons per day). When the onsite sewage treatment system is designed, average daily sewage flow must be estimated. This is where the design must begin in order to determine the size of the onsite system.

Yes, 150 gpd per bedroom is a common value used to estimate sewage flow. This number is based on an estimated daily sewage flow of 75 gpd per person and each bedroom occupied by two people. The number of bedrooms in the home is then multiplied by 150 gpd to get the estimated average daily sewage flow from the household.

You indicate when metered water flows are available, you double the meter number for design purposes. Perhaps some of the following information will support your practice.

Over the years, a number of studies have looked at water use rates. Most were made before the introduction of toilets having a water use of 1.6 gallons per flush. A publication in 1975 found the single largest water use was from the flush toilet, with the laundry and bath tied for second. The data likely would be different today with the advent of low-flow flush toilets.

DOUBLE OCCUPANCY?

A number of studies at that same time showed the mean daily per capita water use to be somewhat less than 50 gallons per day. However, the general practice has been to use a value of 75 gallons as the water use rate for design purposes.

Some research scientists found all bedrooms in a home were normally not occupied by two persons. They suggested the occupancy rate for a home is normally one more than the number of bedrooms. The formula they presented was: Estimated daily water use = 75 (BR+1). Using this formula, a three-bedroom home would have an estimated water use rate of 75 x (3+1) or 300 gallons per day.

Another study used a different approach. A base flow of 66 gpd was established for the basic household uses of clothes and dish washing. Then water use by individuals was evaluated. This study led to the formula: Estimated daily water use = 66+38 times the number of persons. Using this formula a three-bedroom house would have an estimated daily water use of 218

Readers are welcome to submit questions to the Answer Man. Send your question to COLE Publishing by e-mail to editor@pumper.com, by fax to 715/546-3786; or by mail to P.O. Box 220, Three Lakes, WI 54562. We will pass your question along to Dr. Machmeier.



And what will be the cost of this three-bedroom home? The cost certainly varies around the country, but the cost likely will be in the \$150,000 to \$250,000 range. Does it make good economic sense to try and save a few thousand dollars on the size of the onsite sewage system?

gallons per day. Again the occupancy is considered to be the number of bedrooms plus one.

The values from these three different approaches are presented in the following table:

inspection pipe at the drop box and at the end of the trench. Recent figures from an installer friend of mine in Minnesota indicate this trench system would cost around \$5,100.

ESTIMATED SEWAGE FLOWS IN GALLONS PER DAY (gpd)

Number of Bedrooms:	Type I: 150 x BR	Type II: 75 (BR + 1)	Type III: 66 + 38 (BR + 1)
2	300	225	180
3	450	300	218
4	600	375	256
5	750	450	294
6	900	525	332

You can see a number of average sewage flow rates can be used to estimate average daily sewage flow. However, it is necessary to select a sewage flow rate to design and size the onsite sewage treatment system. I would suspect your metered flow might be like a Type III home, but the design value like a Type I.

The size of the soil treatment system depends upon the soil characteristics and the average daily sewage flow rate selected. For an example, let's use a three-bedroom home at 450 gpd requiring 200 lineal feet of trench. The trenches will be 36 inches wide with 12 inches of rock under the 4-inch pipe, 2 inches of rock over the pipe. The rock is covered with geotextile fabric and each trench has an

If a Type II home is assumed, a 300-gpd system would need 133 feet of trench, which would cost less, but not in direct proportion because of some basic setup costs. Let's say \$4,000, or \$1,100 less.

If a Type III home is assumed, a 218-gpd system would need 97 feet of trench. Again, the cost would be less, but not half as much as the 450-gpd system. Let's say \$3,000, or \$2,100 less.

And what will be the cost of this three-bedroom home? The cost certainly varies around the country, but the cost likely will be in the \$150,000 to \$250,000 range. Does it make good economic sense to try and save a few thousand dollars on the size of the onsite sewage system? If I

were the prospective homeowner, I would ask for a full-size system. If I were a developer concerned with costs, I might want to save whatever I can as long as the system lasts beyond the warranty period.

BUILD TO SUIT

If I were selling an effluent distribution system more costly than trench rock, I might use the argument that my system was more effective than rock. I would argue that the size of my system could be reduced compared to rock. By reducing the size of my system, I could then be cost-competitive with rock-filled trenches.

Actually, what would be happening is less sewage flowing into my soil treatment system than the assumed design flow rate. But if no flow measurement were made, I could state my sys-

tem was treating sewage at the design rate.

A sewage flow rate has to be assumed to size and design an onsite sewage treatment system. This is the design rate to which you refer. The "real" or actual sewage flow rate can be determined only by using a water meter. Installing a water meter is a small price to pay for evaluating the performance of the onsite system. The meter will tell if a system failure is due to excessive water use.

I have been recommending installing water meters for onsite systems for years. My advice has, for the most part, fallen on deaf ears. If water meter data had been collected over the years for a variety of onsite systems, we would now have a much better estimate of "real" onsite sewage flows. ■

Installing a water meter is a small price to pay for evaluating the performance of the onsite system



DENVER

TRUCK SALES

Nobody
Beats Our
Quality!

Complete Line of
Pumps and Parts



1996-2001 Western Stars

435 Cats, Jake, 18 speeds 46,000 LB rears on Hendrickson air suspension. New 3360 gallon tank, HXL-400 Masport pump, serviced and checked.
From \$64,950 plus F.E.T. on the tank



1997 KW T-800 Series

60 Detroit, Jake, RTLO-16713 transmission, RT46160 46,000 LB 4.33 ratio, New 3360 gallon tank, Masport HXL-400 pump, New paint serviced and checked.
\$66,950 plus F.E.T. on the tank



1996 IHC 9400

14,000 LB f/a 3406 Cat, Jake, 15 speed transmission, 46,000 LB rears hendrickson air suspension. New 3360 gallon tank HXL-400 pump serviced and checked from
\$62,950 plus F.E.T. On the tank



2001 Freightliners FL 120

C15 475 Cat, Jake, RTLO-18918 trans, RT46160 on Hendrickson spring suspension, 4-way locks. New 3360 gallon tank HXL-400 pump
\$79,950 plus F.E.T. on the tank

Easy Financing and Lease-To-Own WAC!

Denver Truck Sales • 5293 Vasquez Blvd. • Denver, CO 80216
Phone: 303-291-0960 • Fax: 303-291-0244 • www.denvertruck.com

WE'VE GOT DRESSER ROOTS BLOWERS ... AND A LOT MORE

The Dresser Roots blowers are the finest truck mounted units available today. And, as a factory authorized sales and service center we're here to provide the best support for all your blower applications.

We're also here to help with your vacuum equipment repairs, rebuilding, and replacements that also includes our special blower exchange program.

Just give us a call.

 **Roots**

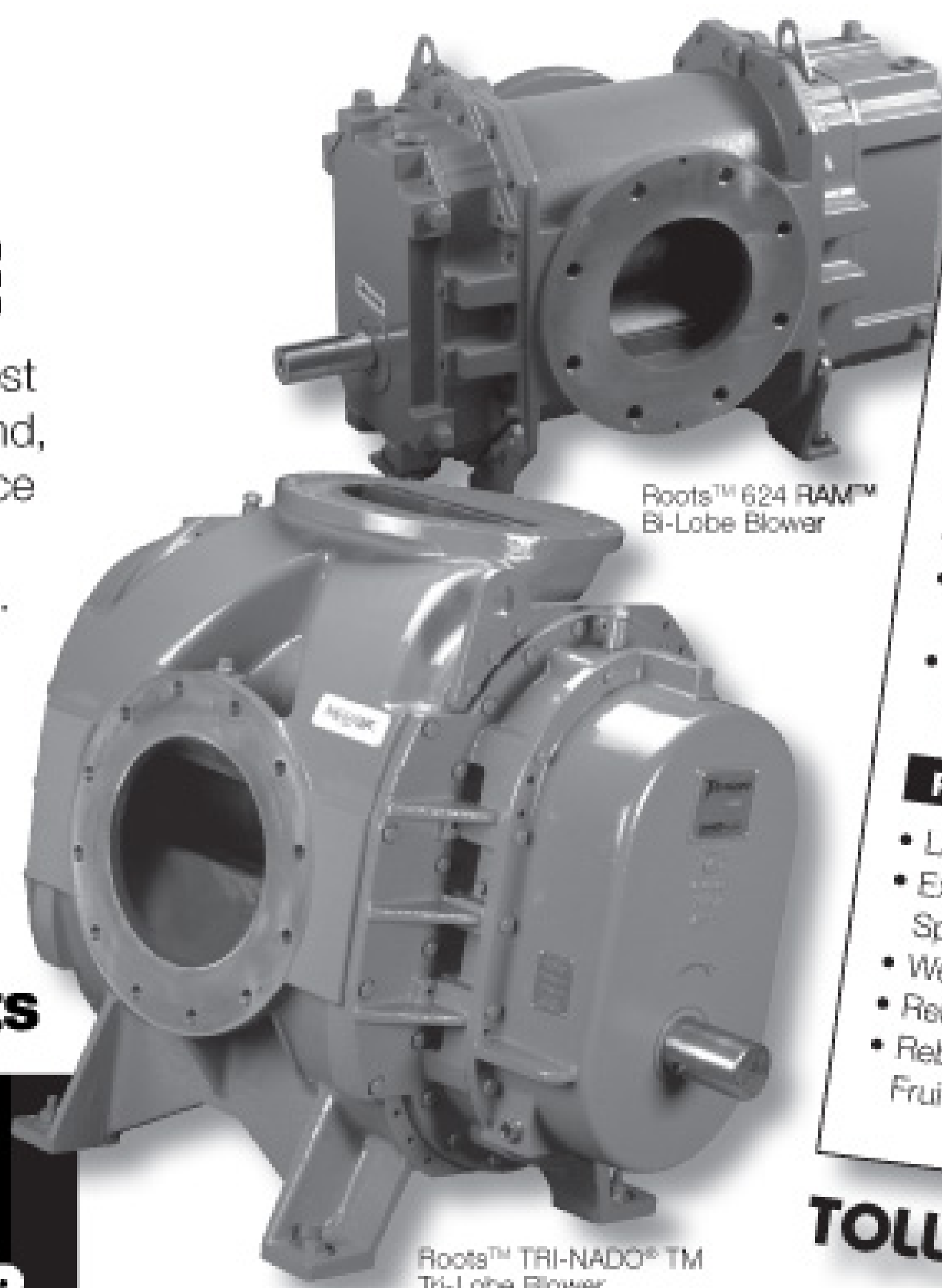

Roots™ 624 RAM™
Bi-Lobe Blower

Roots™ TRI-NADO™ TM
Tri-Lobe Blower

VACUUM PUMPS, TRUCKS & ACCESSORIES

- Aquatech** • Sewer trucks & equipment
- Conde** • Toilet truck vacuum pumps
- Hi Vac** • Industrial vacuum systems
- Metaltecnica** • Valves & accessories
- O'Brien** • Sewer cleaning jettors
- Presvac** • Septic & sewer trucks
- Roots** • Bi-lobe & tri-lobe vacuum blowers
- Stoddard** • Intake filters & discharge silencers
- World-Tech** • Sewer cleaning nozzles & valves

COMPLETE FABRICATION & MACHINE SHOP

- 24 Hour service
- Custom built blower and pump vacuum/pressure packages: electric, gas, or diesel
- Custom parts fabricated or reconditioned including bearings, shafts & sleeves

REBUILD SPECIALISTS

- Largest blower repair center in the Universe.
- Experts in rebuilding blowers: Roots, Sutorbilt, Spencer, and Hibon
- We rebuild all vacuum pump makes and models
- Rehab sewer cleaning trucks and equipment
- Rebuild kits in stock for Schult, Wittig, Moro, Jurup, Fruitland, and Challenger

TOLL FREE: (800) 359-PUMP

Orlando, FL: 800-359-7867 • WWW.PATSPUMP.COM • Atlanta, GA: 800-851-7987

PUMPER WAREHOUSE STORE

SPEND YOUR TAX REBATE/REFUND WITH US!

EPDM SUCTION HOSE

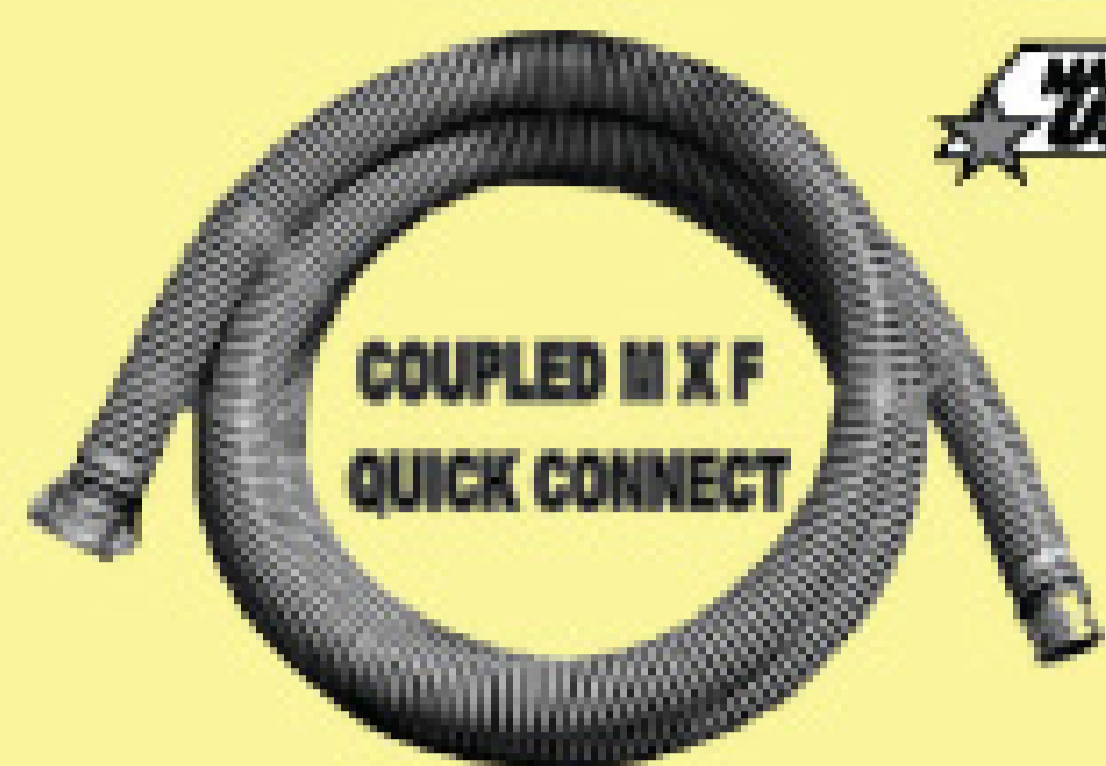

- 3" X 20' \$96.25 **\$79.95**
- 3" X 25' \$115.75 **\$94.95**
- 3" X 30' \$134.95 **\$109.95**
- 3" X 33' \$146.95 **\$119.95**

WE'LL MATCH UP TO 10% OF YOUR TOTAL REBATE!



T-LIFT
\$99.95

FREE CAMLOCK MALE ADAPTER WITH PURCHASE OF LEVER VALVE!

FREE WITH PURCHASE OF THIS!

BRASS LEVER VALVES

- 2" \$112.95
- 3" \$169.95
- 4" \$299.95

HI-VAC SUCTION HOSE CPLD Mx F QUICK CONNECT

- 2" X 20' \$74.70 2" X 30' \$108.70
- 2" X 25' \$91.70 2" X 40' \$142.20



FANTASTIC DEALS ON PUMPS!

JUROP R260 PUMP	JUROP PN33 PUMP	JUROP PN58 PUMP	JUROP PN84 PUMP
\$2,975.95	\$1,205.95	\$1,605.95	\$1,810.95

VARCO FLEXI-JOINT

NO MORE BREAKING OFF AT THE TRUCK!



\$51.99

PVC SANDY GRIP GLOVES



EVERYDAY LOW PRICE!
\$12.95 /DZ

FREE CATALOG

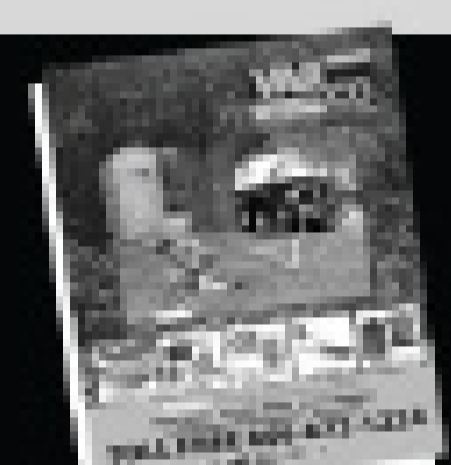

LOW, LOW PRICES - SAME DAY SHIPPING - FAMILY RUN!

TOLL FREE **866-872-1224**

SOURCE KEY 3P8

Pumper

SUBSCRIBE EDITORIAL CLASSIFIEDS VIDEO ADVERTISING

Looking to **BUY** or **SELL**?
Just Submit Your Classified Ad **ONLINE!**

Only \$1.00 PER WORD (\$20 Min.)



It's Easy & Secure!

Your ad will be posted on the *Pumper* Web site within two to three business days after received.

Just go to www.pumper.com; click on "Classifieds;" click on "Place a Classified Ad;" fill in the online form.

MEET THE INSPIRATION FOR OUR NEWEST PORTABLE RESTROOM

**MOMS LOVE
OUR NEW
FAMILY ROOM.**



**FLEXIBLE FINANCING
AVAILABLE NOW**

Lower payments... longer terms...
less interest... deferred payments...
What do you need?

Our sincere thanks to good customers who stimulated our thoughts about the problems of parents with infants at events. That's a stressful situation to say the least.

We needed to customize one of our units to fit their needs. (No problem. We often do custom colors and modified designs for our customers.) Our new Family Room unit is the result. It turned out so well, we decided to offer it to everyone.

The new Family Room enables you to offer something new to event promoters this year. Moms love it and it's a great add-on sale for you.



Listening. Learning. Delivering. Since 1972

99 Crafton Drive, Dahlonega, GA 30533 USA • Phone (800)241-7951 or (706)864-3776 • Fax (706)864-8111 • www.polyportables.com

Only PolyPortables offers high-performance Green Way Products

TOILET DEODORIZERS • TOILET CLEANERS • AIR FRESHENERS • INSECT REPELLANT

All Green Way deodorizers, cleaners and air fresheners are earth-friendly, people-friendly products. They are developed and manufactured in our facilities in Dahlonega, Georgia by Green Way Products, a PolyPortables sister company.



Big Fish

ENVIRONMENTAL

Receiving & Processing

For

**Septage • Biosolids,
Fats, Oil & Grease**

Design • Build

P.O. Box 528 • 12608 Taylor Rd.
Charlevoix, MI 49720

PH: 231.547.4429 • FAX: 231.547.2057
www.bigfishenvironmental.com

Get Pumper magazine for as little as
\$1.00 A Month*

Notes

25,000 of your industry peers welcome *Pumper* every month for the value it brings to their business. Each issue shows you:

- **New tools** to help you win jobs and earn more profit.
- **Ways to save** on office expenses, supplies, advertising, taxes.
- **Money-saving deals** on equipment.
- And much **more**.

Best of all, you'll learn from other successful business owners – how they did it, and how you can, too.

Don't miss an issue –
subscribe today!

*Subscription Rates: 1-year \$16, 2-years \$26, 3-years \$36 for domestic deliveries

Pumper
1.800.257.7222
www.pumper.com

Industry News

Vermeer Acquires Maxi Drill Manufacturer

Vermeer Corp. has acquired the operating assets of Horizontal Rig & Equipment of Conroe, Texas. HRE produces three drills with pullback forces of 500,000, 750,000 and 1 million pounds. Production will be moved to Vermeer's Pella, Iowa, location with distribution through the company's global dealer network. The drills will carry the Vermeer brand name.

Ameri-Can Appoints Andrews Sales Administrator

Mandi Andrews has been appointed sales administrator for Ameri-Can Engineering. She will be responsible for the coordination of all sales quotes, processing and assistance in the selection of custom-built sanitation trailers. She brings 10 years of restroom design and sales to her position.

TOICO Acquires GMF Co., Expands Sales Staff

TOICO Industries has acquired GMF Co. of Johnstown, Pa., and added sales representative Tom Edwards to its staff. Edwards has 30 years of experience in the portable sanitation industry. He will be responsible for sales and customer service in the Northeast United States. The company also has tripled warehouse capacity, moving to a facility at 1439 Londonderry Drive, Woodstock, Ga.

RIDGID Presents Video Contest

RIDGID is celebrating the launch of its new membership site (www.teamridgid.com) with a video contest, "How I Build my Reputation with RIDGID Tools." Customers are invited to record and post an original 1- to 3-minute video illustrating how they built their reputation with RIDGID tools. The contest ends April 30. Five finalists will receive an all-expense-paid trip to Cleveland, to tour the RIDGID headquarters. The grand prize winner will receive \$2,500 in RIDGID tools. ■

**Come In We're
OPEN**
www.pumper.com

Mid Continent Truck Sales, Inc.

891 Adkins Hill Rd. • Norman, OK 73072 • 405-329-5365 • Fax: 405-329-5381 • After Hours: 405-288-6502 • www.vacuumtrucksales.com

Trucks - Trailers - Vacuum Tanks - Pumps



2001 IH 4700, DT466E, Allison auto, non-CDL, air brakes, new MEC 6500 vacuum pump, new 1100/400 vacuum tank.



Thank You For Visiting
Us in Louisville!



2000 Freightliner, Detroit 60 series (430/470 hp) w/fresh overhaul, 10-speed, double frame, new Wally 753LNHR vac pump, new 3400 gallon vacuum tank.



2004 Kenworth T300, Cat C7 (210 hp), 6-spd., 33K GVW, new Wally 753HR (350 cfm), new 2600 gal. aluminum vacuum tank, 2-yr. nationwide drivetrain warranty.



2000 IH 4700, DT466, Allison auto, non-CDL, new MEC 8000 vac. pump, new 1600 gal. vacuum tank.



1998 Freightliner FL60, Cummins 5.9 (210 hp), 6-spd., Masport H75V vacuum pump, General 47 series triplex, 1100/200 gallon vacuum tank.



**LET US QUOTE YOUR NEXT
VACUUM TANK!**



1990 IH 9400, Cummins NTC350 w/fresh inframe, 9-spd., new Wally 753LNHR vac pump, 3500 gallon vacuum tank w/full opening rear door.

MID CONTINENT TRUCK SALES

manufactures and stocks all necessary components to complete your vacuum system. Whether it's pumps, valves, moisture traps, oil catch mufflers, pump frames, etc.

**CALL US BEFORE
YOU BUY!**

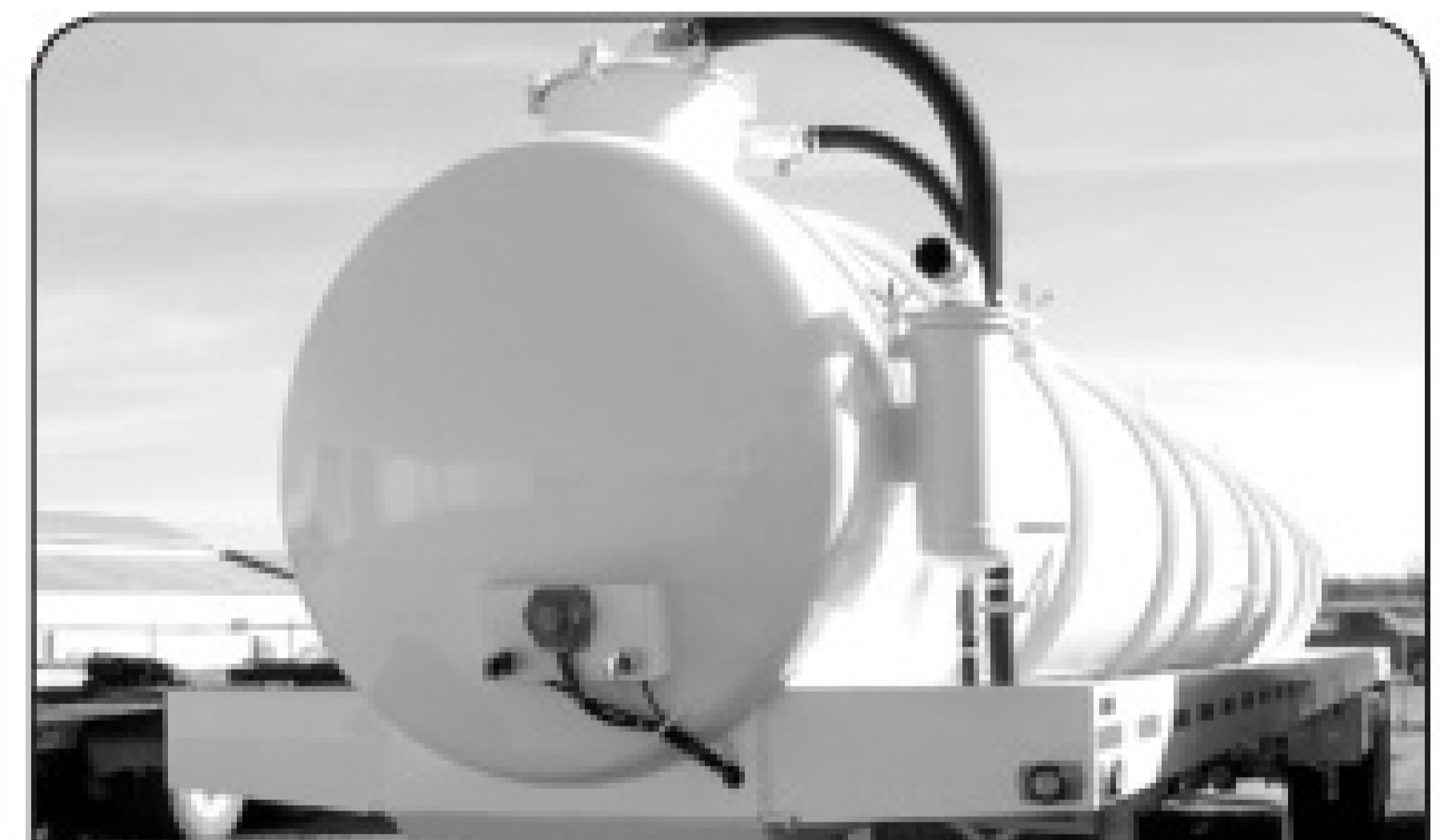

New Fluidmaster 5460 gal. vacuum trailer in stock. Also several used vacuum trailers in stock.

**KSP
PUMPS**

Since 1946



Masport

NVE

AUTHORIZED DISTRIBUTOR



**vallenstein
vacuum pumps**

BOWIE



FLUID AND SLURRY
PUMPS

WE CARRY MOST BRANDS OF VACUUM PUMPS AND PARTS!



WE WILL BUILD TOILET UNITS TO YOUR SPECS!

Call DAVE PERRY for TRUCK quotations and CHUCK RODGERS for TANK quotations.

MARCH Pumper CLASSIFIEDS

2008

- ▶ Advertising
- ▶ Aerators
- ▶ Bucket Machines
- ▶ Businesses
- ▶ Business Opportunities
- ▶ Cable Machines
- ▶ Computer Software
- ▶ Dewatering
- ▶ Drainfield Restoration
- ▶ Drain / Sewer Cleaning Equipment
- ▶ Dredges
- ▶ Excavating Equipment
- ▶ Hazardous Waste Units
- ▶ Hydroexcavation
- ▶ Jettors-Trailer
- ▶ Jettors-Truck
- ▶ Jet Vacs
- ▶ Lease Financing
- ▶ Locators
- ▶ Miscellaneous
- ▶ Parts & Components
- ▶ Pipeline Rehabilitation
- ▶ Portable Restrooms
- ▶ Portable Restroom Sinks
- ▶ Portable Restroom Tanks
- ▶ Portable Restroom Trailers
- ▶ Portable Restroom Trucks
- ▶ Positions Available
- ▶ Positions Wanted
- ▶ Positive Displacement Blowers
- ▶ Pressure Washers
- ▶ Pumps-Dredge
- ▶ Pumps-High Pressure
- ▶ Pumps-Submersible
- ▶ Pumps-Vacuum
- ▶ Pumps-Water
- ▶ Rodding Machines
- ▶ Roll-Off Containers
- ▶ Roll-Off Trailers
- ▶ Roll-Off Trucks
- ▶ Root Control
- ▶ Safety Equipment
- ▶ Septic Tank Forms
- ▶ Septic Trucks
- ▶ Service / Repair
- ▶ Slide-In Unit
- ▶ Sludge Applicators
- ▶ Tanks
- ▶ Tools
- ▶ Trailers- Vacuum / Tanker
- ▶ TV Inspection
- ▶ Vacuum Loaders
- ▶ Vanes
- ▶ Vehicle Tracking
- ▶ Wanted
- ▶ Wastewater Transfer
- ▶ Waterblasting

ADVERTISING

REMINDER POSTCARDS: Advertise full color postcards of your truck, service or products. Great marketing tool. Visit www.postcardprinting.com. Toll Free 1-888-334-4553. (PBM)

BUCKET MACHINES

GRADEBLADE — Convert your toothed bucket to toothless in 60 sec., NO tools needed, fast, inexpensive, fits backhoes, mini-excavators and large excavators. 1-888-372-8933 FREE DVD, literature. www.gradeblade.com. (P14)

BUSINESSES

SEPTIC PUMPING, INSTALLATION AND POTTYHOUSE BUSINESS: Central Illinois. Established 13 years, 2000+ customer base. Great expansion for your current business. Most work in 30-mile radius. Will stay on for 6 months of training if needed. \$125,000. OR buy only name, phone number and customer files, \$110,000. 217-417-0374. (CP3)

2003 F350 4X4 diesel Dyna Vac 125/300 vac system new April 07; Dyna Vac 125/300 vac system spare new in 2003; Explorer trailer hauls 12 toilets, new in 2004; 4 flush toilets, with sinks, 2 handicap toilets, 63 reg. toilets. Asking price \$85,000. Business located in Worcester Boston area. Computer and telephone number included in price. Contact Attorney William Cotting. 508-845-6006. (P4)

Septic, sewer and drain cleaning business located near resort area. High potential with lots of room for growth. Sale includes 3.9 acres of land with 2000 sq. ft double wide home, single wide mobile home with 1-1/2 baths, office trailer, 40x56 garage, 3 Keith Huber Dominator combination trucks, 2 locating ferrets, Cues camera, 2 Scooter cameras, Terralift with truck and trailer, backhoe, 5-ton dump trailer, plus many more extras. Service area is the Peninsula of Maryland and Delaware. Call Mike for details. 410-430-3431 or 410-546-2162. (P4)

BUSINESSES

FOR SALE: Septic and Portable Toilet Business located in White Mountains, Arizona. 150 toilets, 2 ADAs, 3 trucks. For more info, respond to: 11448 East Monte Ave., Mesa, AZ 85209. (PBM)

Thriving septic business in the beautiful northwoods of Wisconsin. One 3500 gallon tank on a 2003 Sterling Acterra, 210,000 miles. Room for growth in area. 2007 sales \$187,000. Asking \$170,000. 715-820-1709. (P4)

BUSINESS FOR SALE located in Central NJ. Septic business was established in 2001. Owner relocating. Sale includes NJ DEP License waste and 3500 gal. 1996 Volvo vacuum truck. A901 license can be used for container rolloff and res./comm. garbage. GO RIGHT INTO BUSINESS & AVOID THE 2-YEAR APPLICATION PROCESS! SERIOUS INQUIRIES ONLY. CALL FOR MORE INFO: 732-849-1900. (CP3)

Septic Tank Pumping & Grease Business in Tennessee: Owner retiring, family owned, in business for 20 years. Two trucks: 2002 Peterbilt, 3,000 gal. tank; 1999 Chevrolet, 2500 gal. tank, garage kept and regularly maintained. Great opportunity for growth. \$160,000 last year; \$200,000 this year. Residential & commercial. \$250,000. 865-579-5699. Ask for Bob or Patti. (P4)

FOR SALE: Septic and portable toilet business Located in Highland, Mi. Family owned for 60 years. 3 pumpers, 1 portable toilet truck, 1 dump truck, backhoe, dozer, approximately 90 portable toilets. Excellent client base, residential and commercial. Selling price \$350,000. Further details for serious buyer only. 248-889-0483 or 248-420-7779; email jan7mom@sbcglobal.net. (P4C5)

FOR SALE: Family owned portable toilets restroom business. Retiring after 33 years. 900 units plus handicapped units, portable wash stations, 4 trucks, 5 holding tanks, 4 trailers. Located in North Western Illinois. Serious inquiries only. Call 1-800-698-6928 or 815-441-8527. (P4)

BUSINESSES

FOR SALE: Septic and Portable Toilet Business located in Holland, Michigan. 10 toilets, 2 sinks, 1 truck. \$5,000 buys all! For more info, call 616-548-5128 or email me: smscamaro75@yahoo.com. (PT3)

MINI-BIODIESEL PLANT ASTM B100 - Turnkey Factory 200,000 to 2 million gallons per year. 818-760-2823. www.stopxon.com. (P3)

FOR SALE: 23-year-old restaurant service company specializing in hood system cleaning and ceiling restoration. Serving WV, OH and KY. Large loyal customer base. Grossing average \$500,000. All vans, equipment and experienced service techs in place. \$300,000. Will train. 304-372-2158. (CP7)

FOR SALE: 20-YEAR ESTABLISHED PORTABLE TOILET BUSINESS IN WV. ± 350 Tuff Johns, ± 50 Satellites, some fiberglass, 6-8 holding tanks (mobile office), 4 toilet hauling trailers: 2006 F550 w/100 gal. water, 250 gal. waste; 2005 F550 w/250 gal. water, 500 gal. waste; 1985 Mack pumper w/jetter, 2500 gal. waste, 1000 gal. water. 250-300 toilets on rental now. Gross \$350,000 yearly or more. Call 304-472-7962 for Tammy. (P3)

BUSINESSES WANTED: Septic pumping, grease trap, drain cleaning and other ancillary businesses wanted. We are buying well run businesses in New England, Mid-Atlantic and Florida. All opportunities will be given proper consideration. Confidentiality ensured. Will move quickly for the right opportunity. Serious inquiries only. Please contact Richard Bedard @ 617-326-3344 or rbedard@bwseptic.com. (PBM)

Long Island, New York: For Sale: Cesspool, Septic, Sewer and Drain Cleaning Company For Sale. 2 pump trucks, 2 porta-pottie trucks (service and delivery). Quality workmanship, has established 3000+ loyal customer base. Great opportunity for right person. Jump in on busy season! Money maker! Debt free! Office/shop/yard also available. Call for more information. 631-472-0677. (PBM)

BUSINESS OPPORTUNITIES

Mr. Rooter franchise for sale in central N.J. Excellent potential for expansion. Will temporarily hold N.J. license. \$275,000. Call 609-868-9024. (CP3)

Attention PolyJohn Owners: Receive a **free CD-Rom** of our products to use in your company marketing efforts. Ask your PolyJohn business coach in your area to send you this material today. 1-800-292-1305 Kell. (PBM)

WWW.ROOTERMAN.COM. Franchises available with low flat fee. New concept. Visit web site or call **1-800-700-8062 x26**. (CPBM)

National Grease Recycling Inc. Let us teach you how to recycle restaurant's waste fryer grease and oil (yellow grease) only. **No trap grease.** Big \$. Over 30 yrs. experience. Will guide you through complete process from collection to processing to marketing to end users. Don't lose your trap business to competitors that offer both services. Call for information. Dewey Walker. 813-752-9535 or 813-758-2552. (PBM)

COMPUTER SOFTWARE

Pumper Plus Billing Software: Regularly \$795. Mention this ad in Pumper.com and purchase for only \$595. Pumper Plus is a billing software package from Galaxy Systems, www.galsys.com/pumperdemo.asp, that handles billing for septic pumping and portable toilet service-type companies. Inquire at solutions@galsys.com or call 800-985-3029. (PBM)

DEWATERING

30-yd. Spectrum turbo fixed-media dewatering box. Blue with tarp. Demo unit used once. \$24,500. Call: 405-360-2100. (P3)

2002 16' MAXIMIZER. Like new, used for two summers. \$30,000 OBO. 937-746-6361. Ask for Scott. (P3)

PLACE YOUR AD ONLINE AT www.pumper.com - IT'S ALWAYS THERE TO MEET YOUR BUSY SCHEDULE

DEWATERING

Buy - sell - trade - lease: Filter presses, belt presses, vacuum filters, filter cloth, dewatering bags, tanks, mixers and more! Call Waste Treatment Equipment Specialties at 440-808-8844. www.wescoequip.com. (PBM)

Two 40-yd. dewatering boxes and one polymer mixing and pumping units with Seepex sludge pumps. 5 years old. Excellent condition. Asking \$20,000/box and \$25,000/pumping unit. Call 1-506-672-2100. (PBM)

EXCAVATING EQUIPMENT

2004 and 2006 Super Products Mud Dog Hydroexcavators for sale or rent. Call 330-270-9900 ext.3. (P3C4)

HAZARDOUS WASTE UNITS

2008 Sterling LT9500 with a new Presvac 3,500 gallon c/s DOT certified 407/412 vacuum tank dump type with full open rear door. Presvac PVB750 vacuum pressure pump (Stock #13294A). www.VacuumSalesInc.com, (888) VAC-UNIT (822-8648). (PBM)

1994 Mack with a 4,400 gallon 2 compartment DOT certified unit. (Stock #5371C) www.VacuumSalesInc.com, (888) VAC-UNIT (822-8648). (PBM)

2008 Peterbilt 340 with a new Presvac 3200 gallon (US), C/S, DOT certified, full open rear door, dump-style unit. (Stock #13335 A,B,C,&D) In production. www.VacuumSalesInc.com, (888) VAC-UNIT (822-8648). (PBM)

2001 Freightliner C120 can and chassis with a new Presvac 3,200 gallon DOT 407/412 certified vacuum pressure tank and a RCF500 pump. (Stock #13329V) www.VacuumSalesInc.com, (888) VAC-UNIT (822-8648). (PBM)

ATTENTION: Fleet of Mack vacuum, emergency response service trucks for sale/trade by owner. Tanks and misc. pumping equipment. 417-619-5111. (PBM)

New Presvac 5,500 gallon, carbon steel, DOT, vacuum tank trailer with pump & engine package. (Stock #13325) www.VacuumSalesInc.com, (888) VAC-UNIT (822-8648). (PBM)

HAZARDOUS WASTE UNITS

1990 Presvac 5,000, stainless steel, DOT with pump engine. (Stock #5008V) www.VacuumSalesInc.com, (888) VAC-UNIT (822-8648). (PBM)

JETTERS-TRAILER

2003 Sreco jetter. Model HP4030 TR/L/P. 300 gallon tank. Gas engine. 28 gpm, 4000 psi. 500' hose. Flexi-cam and VCR monitor. Low hours. Ready to use. Will email more info & pictures. \$23,000. 860-793-4293 ext. 1003. (P3CM4)

New PipeHunter Model 38T44 jetting unit, trailer mounted unit, w/335 Poly water tank, 4,000 psi @ 25 gpm, 600' of hose and attachments. In Stock!!! (Stock #13317) www.VacuumSalesInc.com, (888) VAC-UNIT (822-8648). (PBM)

2 SECA trailer jets. Both have Myers 35 gpm, 2000 psi pumps. New paint on both. Located in Dallas. 972-938-1905. www.empireequip.com. (CPBM)

1995 Harben 4016, good shape, new hose, \$8,200. 2008 laser jet, 4000 psi, demonstrator, \$12,000. 1988 Aqua Jet trailer mount, 2000 psi, 40 gpm, great shape, new paint, wheels, and axles w/brakes, \$9,800. 702-456-5388. (P4C5)

1991 SECA Trailer Jet, 40 gpm pump, low hours, ex-municipal. Unit price: \$8,000. Call Joe 312-208-6373. (P3)

JETTERS-TRUCK

2001 SECA truck jet, Myers 35 gpm, 2000 psi water pump, 1000 gal. plastic water tank, new paint. Was a city owned unit. Located in Dallas. 972-938-1905. www.empireequip.com. (CPBM)

1997 Sreco HV 2000 truck jet, 65 gpm, 2000 psi water pump, 1500 gallon aluminum water tank. Was a city owned unit. Located in Dallas. 972-938-1905. www.empireequip.com. (CPBM)

2006 Chevy TC6500 cab & chassis truck mounted jetting unit with JET EYE camera system, 3,000 psi @ 50 gpm, 1,000 gallons water, 600' hose, 500 cfm blower, debris tank and attachments. (Stock #13234) www.VacuumSalesInc.com, (888) VAC-UNIT (822-8648). (PBM)

JETTERS-TRUCK

Vactor water jet on a 1998 Ford F-800, Cummins diesel, 17,338 miles, automatic, 1000 gallon water tank. Needs water pump. This truck is like new. 972-938-1905. www.empireequip.com. (CPBM)

JET VACS

1997 VacCon V390THA on a Ford, 3-stage fan, articulating hose reel, extendible boom, new white paint. Located in Dallas. 972-938-1905. www.empireequip.com. (CPBM)

2003 Sterling LT7501 with a Vac-Con Model VPD4216LHA/1300 combination vacuum jetter unit. (Stock #4648C) www.VacuumSalesInc.com, (888) VAC-UNIT (822-8648). (PBM)

1991-2002 Vactor 2100. Stock units are available. Previously municipal owned. Rebuilt by factory authorized Vactor dealer. Financing available! Look for our truck stop ads. Call Joe Donlon 312-208-6373. (CP3)

1989 2110-C, L8000, new paint, 80 gallon, 2,000 psi pump rebuilt in 2007, 10 cu. yd. debris tank, rubber coated, telescoping boom, new boom hose 2007, articulating hose reel, 600' hose, one-stage fan replaced in 2007, 8' extendable boom, new vac tubes, with Vactor Higbee, new extending catch Payson tube, root cutter, saws and ripper cutter, nozzles, plus culvert clean nozzles. \$50,000 OBO. Well taken care of truck. Will consider trade plus cash. Ph 309-853-5270. (C4)

1995 Safe-jet on a Ford L8000 chassis, automatic, tandem axle, Meyers 60 gpm pump, 2000 psi, 600' new 1" hose, articulating reel, 1000 gal. water tank, 5-yd. debris box, telescoping boom, 6' vacuum hydro-excavator tube, chain root cutter with skid plates, 91,427 mi. \$37,000 OBO. msubola@yahoo.com, 608-241-2382. (CP3)

1980 Ford F800 w/Model 810 Vactor: 68,610 miles, 4,750 hours, single axle, 1,000 gal water tank, 10 CY debris tank, good pumps, motors. Best offer. Call Jim @ 419-243-5108. jimk@edkellysons.com. (CP3)

1995 Vac-Con, reconditioned by Vac-con 2 years ago, 12-yard debris, 1500 gallon water, 80 gpm water pressure, 2000 psi, 74000 miles, runs good. \$64,000. 845-374-1161. (CPBM)

JET VACS

For Sale: 1989 2500 Intl. tandem jet/vac, B10 Aquatech, runs good, \$20,000 OBO. 304-799-4630 or ableseptic@verizon.net. (CP3)

1999 Vac-Con, 12 cubic yard on International, factory rebuilt engine 2005, running complete, 63,436 miles, 80 gpm, 2000 psi, PD, Spicer trans., articulating hose reel. \$98,000. 610-692-9160. (CPBM)

1991 Vactor 2110 on Ford L-8000, single fan modified with a hydro excavation water pump in addition to the original sewer clean out pump, 8' boom, 61,883 miles. \$35,000 OBO. 858-792-2479. (P3)

10/2002 Vac-Con on a 2003 Sterling, 8300 hours, 63,000 miles. 9-yard debris tank, 3-stage fan blower, 80 MPG Meyers/Cummins aux. \$107,000. 904 571-4688. (P3)

2006 2103 Vactor mounted on 2007 Sterling Acterra 4x2, auto, combo sewer cleaner, 500 gal. water tanks, 3.5 yd. debris tanks, PD blower, hydraulic pump 40 GPM @ 2500 PSI, 500' hose reel, 6" tubes, brand new condition, 11,000 miles. No CDL necessary. \$134,000. 561-718-2736. (CP3)

2000 Aquatech B-15 on a Sterling L9513, PD blower, 65 gpm, 2000 psi pump, rear hose reel, 1500 gallon water tanks, 15 yard debris tank. Was a city owned unit. Located in Dallas. 972-938-1905. www.empireequip.com. (CPBM)

1998 VacCon V312THA on a Ford LT8000, 3-stage fan, 65 gpm, 2000 psi pump, extendible boom, articulating hose reel, 12 yard debris tank, new paint. Was a city owned unit. Located in Dallas. 972-938-1905. www.empireequip.com. (CPBM)

Jack Doheny Supplies Inc. offers a full range of late model combo units and DOT industrial vacuum loaders. Call us @ 1-800-3DOHENY. (CPBM)

1998 Vactor 2110 on a Freightliner FL80, 28,213 miles, 2-stage fan, 80 gpm, 2,000 psi pump off system accumulator. Was a city owned unit. Located in Dallas. 972-938-1905. www.empireequip.com. (CPBM)

Low hours, 1995 Vac-Con, 12-yd. debris, new water pump, newly rebuilt Roots blower, auto. trans., AC, tank vibrator, privately owned. \$65,000. 1-800-930-1123 or 954-981-2133. (CPBM)

JET VACS

2002 VacCon V390LHA on a Sterling L7501, articulating hose reel, 10' extendible boom, 3-stage fan, pump-off system, 65 gpm, 3000 psi pump, new paint, excellent condition. Located in Dallas. 972-938-1905. www.empireequip.com. (CPBM)

Vac-Con model VPD4209THA on a 1997 Ford, PD blower, 4200 cfm, articulating hose reel, extendible boom, new white paint. Was a city owned unit. In excellent condition. 972-938-1905. www.empireequip.com. (CPBM)

LEASE/ FINANCING

North Star Commercial Credit: Commercial Loans for Trucks or Equipment. Flexible purchase programs to fit your budget. 21 yrs. in the industry. Contact Tom Myers - 877-804-2274. (CPBM)

BSM Financial Group is a nationally recognized finance company. We offer flexible payment schedules for all types of equipment new or used. Trucks, pumps, jettors, portable toilets, and software easily financed. We do first time start-ups, established businesses, and challenged credit. Call Brett at 877-524-7972 or email brett@bsmfinancialgroup.com. (PBM)

EQUIPMENT FINANCING WITHOUT ALL THE HEADACHES. *Our specialty is credit scores as low as 600; *Application only up to \$250,000; *Start-ups and young businesses up to \$130,000; *Any type or any make equipment new or used. Let us show you the money. We are in our 20th year. Call toll free at 866-259-5370. BSG Services LLC. (P3)

MISCELLANEOUS

Top quality aerators at wholesale prices. We have replacement units for most name brands and also carry Linear Regenerative Rotary Vane pumps. Flagg Air, Gast, Thomas, FPZ, Secoh, Medo and more. Call a company that understands aerators and aeration systems. Septic Services Inc. 800-536-5564. (CPBM)

FOR SALE: 1,000 gallon dual compartment septic tank form, top pour, excellent condition. \$5,000. Ph: 724-475-4625. (P3)

BUY IT - SELL IT - PLACE IT - www.pumper.com - AVAILABLE ANYTIME, ANYWHERE, ANY DAY

MISCELLANEOUS

DISCOUNT ALUMINUM: ARE YOU PAYING TOO MUCH? 1,000 lb. minimum quantity. 5052/5454/5083/5086. .063 - 5.0" thick. All widths. Contact Jayson. 1-888-540-0066.

(PBM)

FULL OPEN DUMP TANK, 2000 gallons, mounted on 1987 Ford F700, diesel, 5 speed, 310 CFM vac pump, big tool boxes, same owner since 1989. \$8,900. 405-235-8600. (P4)

PARTS & COMPONENTS

For Sale: Used Hibon Blower 9100 type SIAV100, used Hibon Blower STAV501, (2) used vane pumps #31817. 330-270-9900 ext. 3. (P3)

PORTABLE RESTROOMS

40 Blue Taurus toilets for sale. Good condition. \$200 each. Call Chris or Bruce 770-439-3131. Atlanta. (P4)

PolyPortables: 43 yel. w/white tops @ \$300 ea., 5 handicap lt. blue w/white tops @ \$500 ea., 4 yrs. old, nice shape. Michigan. 989-743-5055. (PT4)

300 tan PolyPortable units fair to good condition and jobsite ready. \$250 ea. OBO. Please call 863-655-2940 or email midflorida@areyoureadytopotty.com. (P4)

USED PORTABLE TOILETS: In Chattanooga, TN. Satellites, Poly-Portables, and PolyJohns ready to rent. Nearly 200 units to choose from. \$195 each. Can deliver 24 units at a time @ \$2.25 a mile. Also available 100 Synergy Ultras VIP toilets used only for special events, like new. 30 units are 6 years old and 70 units 5 years old. Sold only as group for \$32,000. Call Charlie 423-894-9994 or e-mail charlie@pitstopportables.net. (PT3)

Over 500 grey PolyJohn units next to new condition. Starting at \$200 each. Ready to earn you money! Located in SW Florida. Call 888-697-6943; erin@amberjack-inc.net. (PT5)

Over 600 PolyJohn units 1-2 years old. Starting at \$300 each. Minimum purchase of 26 units. 772-562-4604. kim@reliablepolyjohn.com. (PBM)

PORTABLE RESTROOMS

FOR SALE: Used portable toilets: Polysans, Hightechs models in Northern Ohio. \$100 to \$200 each. 419-466-1349. (PT5)

25 PolyPortable handicapped units. 150 PolyPortable standard units. All 3 to 4 years old and in good condition. Ready to rent. Call John at 860-302-7235. (P3)

FOR SALE: PORTABLE TOILETS: 500+ PolyJohn standard tan units; 500+ PolyPortable standard tan units; poly skids, white tops & corners. Good to very good, excellent condition. Save 50-60% off cost new. Quantity order discounts. Call Bob Sartor in Fla. at 352-796-4540. For serious buyer, can arrange shipping. (PTBM)

Portable Toilets: Poly constructed, molded seat, urinal, latching door. Handicap accessible units available. New and used. CCI/Brian Touey 805-896-3777. (PBM)

PORTABLE RESTROOMS: Used PolyJohn Fleet unit portable toilets. Brown in color. Good condition. \$150 each. Volume discounts. Call John at 352-266-4036 or email john@floridaexpress.us. (P3)

PORTABLE RESTROOM SINKS

(4) PolyJohn 2-person sinks, (27) PolyJohn 4-person sinks. All have soap dispensers and paper dispensers. Ready to go on a job site or festival grounds. All must go. \$250 each. 989-746-0009. (P3)

(4) PolyJohn 4-place sinks. Serviceable but need minor work (soap dispensers/pumps). \$175 each or all for \$600. Chris. 715-395-4000. (P3)

PORTABLE RESTROOM TANKS

Single or multiple compartment tanks. Choose mild, stainless, or galvanized steel. Capacities from 100 to 6000 gallons, any diameter. Parts and accessories to build your own and save money. 800-545-0174. www.tanksandpumps.com. (PBM)

IF YOU ARE USING AN
800 NUMBER

IN YOUR AD, BE SURE IT CAN BE USED
IN ALL AREAS NATIONWIDE.

PORTABLE RESTROOM TRAILERS

2006 Wells Cargo Standard Comfort Elite III Restroom Trailer for sale. Lightly used for events. \$19,950. Call Chris or Bruce 770-439-3131. Atlanta. (P3)

(31) Used restroom trailers, some need repair. Great winter project! Located in Portland, OR. Send e-mail for photos and details. These trailers will be sold cheap and quick! E-mail sanipot@comcast.net or call Bruce Phillips at 503-519-6959. (PT3)

RESTROOM TRAILERS FOR SALE: New in 2007. Various sizes available. Ready for immediate use. 410-266-7812 or go to www.restroomtrailers.org for pictures and details. (P4)

Restroom Trailer - Platinum Series: 30', new and used. Women's - 4 stalls, 2 sinks. Men's - 2 stalls, 3 urinals, 2 sinks. CCI/Brian Touey 805-896-3777. (PBM)

1997 Ameri-Can 32' Restroom Trailer: 7 women's stalls, 3 mens stalls, 4 urinals. Ready to rent. 920-979-7713. (PT3)

Restroom Trailer - Gold Series: 32', new and used. Women's - 5 stalls, 2 sinks. Men's - 2 stalls, 2 urinals, 2 sinks. CCI/Brian Touey 805-896-3777. (PBM)

New and used **RESTROOM TRAILERS** available immediately. 8 to 34 foot luxury trailers. Comforts of Home Services Inc. 877-382-2935. (PBM)

WANTED: Would be interested in purchasing used PortaLisa restroom trailer. Call 601-879-3969. (PT3)

PORTABLE RESTROOM TRUCKS

1995 F-250 club-cab 4x4, 7.3 diesel, auto., 186,000 miles, 300/100, Conde Super 6 vacuum pump, 5 HP Honda engine, tires 75%. \$15,000. 208-879-2800 Idaho. (P3)

Model 1100 (750/350) Crescent Rectangular Vacuum Tank up-fitted to a **2007 International 4100** (pre-emissions) chassis. Carry 8 units, Masport pump and traps. **Now Available!** View our website www.crescent-tank.com. **Crescent Tank Mfg.** 585-657-4104. (P3)

PORTABLE RESTROOM TRUCKS

2002 4300 International, 25500 GVW, DT466, Allison, A/C, air brakes, 3-compartment tank (450/950/250), M-10 Moro pump, spot lights, 2 Burk water pumps for fill and spray down, restroom carrier. Pictures www.aacoinc.com/classified. Located Phoenix, AZ. \$40,000. 208-362-3193. (P3)

Portable Toilet Service Trucks: Reducing fleet, photos on request. Must sees: 2000 International 4700, 16' flatbed, 171,824 miles. 2004 International 4300, 2000 gallon Huber aluminum tank, 1500 waste/500 water, 116,475 miles. 2006 Freightliner M2-106, 22' flatbed will haul 12 Poly Portables, side lift gate and 100 gal. water tank. 2006 Freightliner M2-106, 47,000 miles, 1900 aluminum tank, 1400 waste/500 water. Call Anthony or Joey Boyett for prices at 251-946-3250. (PT4)

1999 F-550 Satellite, 600/350, 7.3 diesel auto, Conde Super 6 vacuum pump, tires 90%. \$18,000. 208-879-2800 Idaho. (P3)

Model 1100 (750/350) Crescent Rectangular Vacuum Tank up-fitted to a **2007 GMC 5500** (pre-emissions) chassis. Carry 8 units, Masport pump and traps. **Now Available!** View our website www.crescent-tank.com. **Crescent Tank Mfg.** 585-657-4104. (P3)

1998 International 4700 with a 1,500 US gallon, 2-compartment (1100/400 split), carbon steel, portable toilet service unit. (Stock #8734V) www.VacuumSalesInc.com, **(888) VAC-UNIT (822-8648)**. (PBM)

2004 Chevy 1-ton, Duramax diesel, 373 axle, flatbed w/power liftgate, 2 storage boxes, 300 gal. waste & 120 gal. fresh, Honda electric start engine, new tires, 70,000, excellent cond., tank & truck. \$29,000. Michigan. 989-743-5055. (PT4)

USED '04 Model 800 (550/250) Crescent Rectangular Vacuum Tank up-fitted to a **'04 Chevy 5500** chassis. Tank upgraded with new Masport pump and traps, sanded, primed and repainted. Chassis has new brakes, pad, rotors, 6 new tires and also sanded, primed & painted. See pictures and additional upgrades on website www.crescent-tank.com. **Crescent Tank Mfg.** 585-657-4104. (P3)

PORTABLE RESTROOM TRUCKS

2005 F550 Ford, 2WD, 6-speed manual, 71,000 miles, white, 600 waste, 250 fresh, 12 volt water pump, Jurovac vacuum pump, PTO-operated, good spare/tires, 2-unit carrier. Excellent condition. Mississippi. \$26,000. 662-803-1592. (P3)

Model 800 (550/250) Crescent Rectangular Vacuum Tank up-fitted to a **2008 Isuzu NPR-HD** chassis. Carry 6 units, reduce fuel costs and improve productivity. View our website www.crescent-tank.com. **Crescent Tank Mfg.** 585-657-4104. (P3)

2001 Ford F-550 and 2002 Ford F-550 toilet trucks for sale in New Jersey. Both trucks are in excellent shape. Visit our website at www.vansant.info or call us at 732-367-0286. (P3)

1998 Chev. 3500 dually gas, 4x2 auto, 500/200, M-2 vacuum/pressure, 8 HP Honda engine, 103,000 miles, tires 90%. \$15,000. 208-879-2800 Idaho. (P3)

1999 Freightliner FL60 with a 1000 waste, 250 mix, 250 water, stainless steel, portable toilet service unit. (Stock #2104V) www.VacuumSalesInc.com, **(888) VAC-UNIT (822-8648)**. (PBM)

2000 F-550 Satellite, 600/350, 4x4 7.3 diesel auto, 136,000 miles, Super 6 Conde vacuum pump, tires 90%. \$20,000. 208-879-2800 Idaho (P3)

1996 International 4900 Series. White, DT466, 6-speed, A/C, P/S, A/B, 11R22.5 tires, 12 ft., 21 rear, Masport pump system, 1600 gal. sewage, 500 water, hose reel, (2) unit HD rack, 250,000 miles. Solid front-line unit. Very good condition. \$22,500 OBO. 352-796-4540. (PTBM)

2007 Chevy C7500 cab & chassis with a new 1500 waste, 500 water, aluminum portable. Call for pricing. (Stock #13289) www.VacuumSalesInc.com, **(888) VAC-UNIT (822-8648)**. (PBM)

1994 International 4900 Series. White, DT466, 6-speed, A/C, P/S, A/B, 11R22.5 tires, 12 ft., 21 rear, Masport pump system, 1600 gal. sewage, 500 water, hose reel, (2) unit HD rack, 382,000 miles. Good standby/ spare service unit. Average condition. \$18,500 OBO. 352-796-4540. (PTBM)

PLACE YOUR AD ONLINE AT www.pumper.com - IT'S ALWAYS THERE TO MEET YOUR BUSY SCHEDULE

PORTABLE RESTROOM TRUCKS

1979 F-360 gas dually w/40,000 miles on new engine, 4-speed, 270/100 tank, new 8 HP Honda engine, new Masport M-2 vacuum/pressure pump, tires 90% plus extras. \$10,000. 208-879-2800 Idaho. (P3)

2004 GMC 5500 with a 1,000 US gallon, 2-compartment (700/300 split), carbon steel, portable toilet service unit. (Stock #0226V) **www.VacuumSalesInc.com, (888) VAC-UNIT (822-8648).** (PBM)

2001 4700 International, 25500 GVW, engine DT466, 7-spd./OD, A/C, air brakes, 3-compartment tank (450/850/200), M-10 Moro vacuum pump, spot lights, pressurized water spray down & fill, restroom carrier. Pictures www.aocinc.com/classified. Located Salt Lake City, \$38,000. 208-362-3193. (P3)

(2) 2005 335 Peterbilts, none CDL, 40,000 miles, like new, auto, air, 1500 waste/500 water with pressure washer, Progress tank, 2-unit carrier. \$68,000 each. 608-835-3459. (PBM)

2001 International 4900 Series. White portable toilet pick-up, delivery and service unit. 12 ft., 18 rear, Masport system, hyd. brakes, P/S, A/C, 10' deck with hydraulic lift gate. Unit carries 4 toilets. 38,000 miles. Excellent condition. \$28,500 OBO. 352-796-4540. (PTBM)

1999 Isuzu FTR, 190 hp, 6 cyl. diesel, 25,900 GVW, new Allison auto with 2-yr. warranty, Jay's Inc. 1,300 gallon 800/500 split, National 190 cfm vac. pump, Burks DC-10 wash down pump, heated dump valve, heated bucket fill, heated water pump, 60' hose reel, 2-unit toilet carrier, and more. 123,800 miles. \$35,000. Call Dale 708-878-4391. Located in Illinois. (PBM)

2002 International Pumper Truck: 4700 series, DT466, automatic, air brakes, 1200 gallon waste, 300 gallon fresh water, Masport 75 pump. CCI/Brian Touey 805-896-3777. (PBM)

2006 C5500 Chevrolet, miles in 40s with aluminum and steel tanks. Still under warranty. Slide-ins 600/250, \$9,000. Portable toilet transport trailers: 8, 10, 12, 14, 16, 20 haulers. New portable toilet trucks and new and used septic trucks. We stand behind everything we sell. Lane's Vacuum Tank Inc. 1-800-592-3308. (PBM)

PORTABLE SHOWER TRAILERS

2004 Ameri-Can Shower Trailer: 8 unisex stalls. On-demand propane hot water, fresh water hook up or 300 gallon on board. 920-979-7713. (PT3)

POSITIONS AVAILABLE

Plumbing company in Florida seeking enthusiastic class B CDL tanker endorsement licensed pump/vac truck operator. Experience preferred. Medical, 401K, holidays, vacations. 1-800-930-1123 or 954-981-2133. (CPBM)

Looking to relocate to Sunny South Florida? Are you an experienced plumber or sewer and drain professional? Then you deserve to earn \$80K/year, \$5,200 bonus and a new truck and full benefits. Please call Don at 1-800-930-1123 or 954-981-2133. (CPBM)

North American Services Group (NASG) is one of the largest and fastest growing privately held industrial cleaning companies in North America. We are searching for experienced supervisors, operators, and laborers for industrial cleaning, water-blasting, vacuum truck services, abrasive blasting, hydro-excavation and plant maintenance for our Salt Lake City, UT and Elko, Nevada expansion. We offer excellent pay, great benefits, including 401K with match, overtime and relocation package for suitable candidates. Please contact Rick Matteson at 800-866-6247. (P3C4)

Established **Industrial Cleaning Company** seeks operators & assistant/**Operations Manager**. Successful applicants need to be self motivated, hands-on, good communicator, willing to travel & learn the position throughout Arizona. Business based close to Tucson, AZ. Salary based DOE. Benefits, 401K, plus other incentives for the right applicant. Fax resume to 520-385-0557. (P3C4)

PUMPS-SUBMERSIBLE

Wholesaler for Hydromatic, Zoeller, Myers, Liberty and ABS pumps. We also supply Grinder pumps and basins. Will help you size them. Septic Services Inc. 800-536-5564. (CPBM)

PUMPS-VACUUM

(3) 720 Battioni water-cooled pumps for sale. Good working order. \$1,400, \$1,200, \$850, or best offer. 616-897-3050. (P3)

460 Challenger pump, approx. 7 years old, clockwise rotation. \$1,000 OBO. Day 810-560-3268; Evening 734-878-5228. (PBM)

Complete line of Moro, Conde and engine-driven, stand-alone pump systems, DC10 washdown pump. Call us for any of your vacuum truck parts from shut-off valves, primary and secondary valves, hoses, vacuum pumps and drive systems. Septic Services Inc. 800-536-5564. (CPBM)

New **Masport** pumps and genuine **Masport** components. Compare our price before you buy. W-K Machine & Supply Co. Call 1-800-633-8947. Distributor. (PBM)

Vacuum Pumps - New, used, or rebuilt. 30 to 900 cfm. All major brands; air, water, or fan cooled. Rebuild specialists - rebuilt PB, M3, M10, and others available. 800-545-0174. www.tanksandpumps.com. (PBM)

Need a vacuum pump for your portable pumper? Try our new 30 cfm, 12 volt system. Less noise, no fuel. Automatic oiling, cheaper than a gas engine. 800-545-0174. www.tanksandpumps.com. (PBM)

SAFETY EQUIPMENT

Large quantity of Tyvek, Saranex and CPF3 suits, slush boots. Rubber, leather and nitrile gloves. Fittings and tank entry equipment. Retail value over \$300,000. Sale price \$150,000 OBO. Will separate. 716-284-1260 or 716-510-2482. (CP4)

SEPTIC TRUCKS

1999 Vactor 2115, 1999 International, 15CF debris body, Roots PD vac. blower, 8' hydraulic boom w/joystick, hydraulic rotating hose reel, 600'x1" sewer jet hose, 80 gpm @ 2000 psi water jet system. Call for full specs and details. 305-251-8104. (P4)

1985 International, 400 Cummins, 145,000 on inframe, trans. rebuilt, new PTO and Wally pump done by Intl. dealer, 3400 gal., A/C, 70% rubber, good runner. \$22,000. In AZ. 928-667-0021. (PTI3)

SEPTIC TRUCKS

2001 Mack RD686DT with a 3,200 gallon (stainless steel) vacuum tank with a Masport HXL400WV water cooled pump. (Stock #7665V) **www.VacuumSalesInc.com, (888) VAC-UNIT (822-8648).** (PBM)

2003 Sterling 9513. 430 Mercedes power. Aluminum rims, fuel tank and tool boxes. Custom built unit. 4000 gallon steel vacuum tank. 750 water cooled vacuum pump. 35,000 miles. Mint condition. Always garaged. \$65,000. Call 781-585-1725. (CP4)

1995 Peterbilt Model 379 with 1980 Reli aluminum 8000 gallon vacuum tanker. Both have been restored and are ready to haul/pump. \$45,000. 603-731-3212. (P3)

1990 International septic truck. DT 230 hp engine. 2600 gal. tank. Fruitland pump. New paint and tires. Call for more info. \$16,000 neg. 1-920-743-5099. (P6)

1981 Ford LTS 8000. Restoration 90% complete. Excellent truck. Restoration picture available. 2800 waste, 200 fresh. \$30,000 invested. I'll complete or you can. 330-784-6358. grandpahoov@yahoo.com. (P3)

2001 Freightliner, 3300 gallon, Mec 8000. Looks and runs excellent. Washed daily and garage kept. \$49,900. 231-228-7499. (P5)

1990 Ford Cargo Star 8000, diesel, 2500 gallon waste, 200 gallon fresh, good truck. Located in Wyoming \$12,000. Call 307-630-2717. (P3)

1977 International 4300, 290 Cummins, 3000/100, 260 Jurop vacuum/pressure pump, tires 75%. \$12,500. 208-879-2800 Idaho. (P3)

2004 Peterbilt Model 330, CAT motor, air ride susp., fully loaded, 3600 gal. Transway tank. Truck is like new, 50K miles, red. Asking \$82,000. 978-692-3085. (PBM)

Are you looking for a good used pump truck from 500 to 4000 gallons ranging from \$5,000 to \$37,000? Call Jerry at 918-381-9072. (P3)

2001 Mack RD686DT with a 3,200 gallon (stainless steel) vacuum tank with a Masport HXL400WV water cooled pump. (Stock #7948V) **www.VacuumSalesInc.com, (888) VAC-UNIT (822-8648).** (PBM)

SEPTIC TRUCKS

1985 Ford F-8000 pump truck, 2500 gallon, Battioni pump, 3208 CAT engine, Eaton transmission. \$12,000. 386-566-2277. (P3)

1992 Ford L9000, AC, 3700 gallon tank. Moro M-9 pump, hoisted unit, full opening rear. Good truck for washbay cleaning and septic tanks. \$27,000. 913-631-5201. (P4C5)

1990 International, 2500 gal., good runner, A/C, Moro pump, 70 gal. fresh water, clean truck, single axle. \$19,000 OBO. Located in AZ. 928-667-0021. (PTI3)

1997 Peterbilt Model 357, CAT 3306 motor, Fuller 8-speed trans., 4200 gal. Transway tank, 800 Transway pump, 220K miles, red. Excellent condition, ready to work. \$55,000. 978-692-3085. (PBM)

2001 Intl. DT-466, 7-spd. tandem, new 3600 gal. tank, Masport 350 cfm vacuum pump, 237,000 miles, \$49,000. 2000 Intl., DT-466, auto., new 2300 gal. tank, 350 cfm Masport pump, 147,000 miles, \$44,000. Other new & used toilet & septic trucks available. Everything we sell has warranty. Lane's Vacuum Tank Inc. 1-800-592-3308. (PBM)

1997 Mack pumper, 3800 gal. steel tank, 450,000 miles. Asking \$42,500. Call 1-716-432-2885. (P3)

1994 FL 70 Freightliner, 1620 gal. full door dump, new Masport water cooled pump, new tires, new brakes, 6" air dump, 125-gal. wash-down tank. Excellent condition. One owner. 605-286-3359. (P3)

Pre-owned Coleman tank (tank only), 3,500 gallon, c/s vacuum pressure tank. (Stock #VS102V) **www.VacuumSalesInc.com, (888) VAC-UNIT (822-8648).** (PBM)

1984 International S2300 vacuum pump truck, 2600 gallon tank with Moro M10 pump. Good starter or backup truck. \$19,500 OBO. 229-834-4775. (P4)

2007 new Acro trailer, 7,000 US gallon aluminum vacuum pressure tank. (Stock #13273 A&B) **www.VacuumSalesInc.com, (888) VAC-UNIT (822-8648).** (PBM)

Need a tank and truck, any size, any make truck? Let us help you get the best deal. Custom built to your specs. For information and a price quote call 800-545-0174. www.tanksandpumps.com. (PBM)

BUY IT - SELL IT - PLACE IT - www.pumper.com - AVAILABLE ANYTIME, ANYWHERE, ANY DAY

SEPTIC TRUCKS

Pre-owned Presvac tank (tank only), 3,500 gallon, c/s vacuum-pressure tank. (Stock #VSIT01V) www.VacuumSalesInc.com, (888) VAC-UNIT (822-8648). (PBM)

2007 Peterbilt 340 with a new Presvac 3600 gallon (US) aluminum vacuum tank unit. (4) 2009 Models Coming Soon. (Stock #1329 C, D & S). www.VacuumSalesInc.com, (888) VAC-UNIT (822-8648). (PBM)

SHOWER TRAILER

Shower Trailer - Gold Series: 32', new and used. Men and women sides each have 3 private shower stalls with changing area, 1 restroom stall, 1 sink. CCV/Brian Touey 805-896-3777. (PBM)

SLIDE-IN UNITS

Start up/Back up — Complete package; '07 slide-in unit (250/200), '07 Dodge 2500 4x4. Slide-in unit has a Masport pump with a Honda electric start 5 hp engine. The '07 Dodge has a HO Cummins diesel engine with a 6-speed transmission. See pictures on website www.crescent-tank.com. Crescent Tank Mfg. 585-657-4104. (P3)

SLUDGE APPLICATORS

1987 I.M.E. Super/Jector 3500 gal. vac/pressure tank, 250 hrs. on 3208 Cat re-man. motor. Pearson PB8 vac pump, four-knife shank, tires 66x43.00/25 at about 60%. Unit in good condition. \$38,500 OBO. Day: 810-560-3268; Evening: 734-878-5228. (PBM)

Agco Terra Model #2004 Gator sludge applicator. 4 hours on rebuilt engine, 4 newer tires. Located in Ohio. Call 412-403-4027. (P5)

TANKS

Used 3050 gal. vacuum tank 72" x 16', primary/secondary shutoffs, hose trays, 20" top/rear manways, 3/3" site glass, 4" air valve with rebuilt DRUM S440 vac, pump 400 cfm. \$5,900 OBO. Pictures 402-371-7024. (P6)

Used 3600 gallon vacuum tank, 72" x 16' w/hose rack, front/rear valves, primary/secondary shut offs, 2 manways, site tube. \$3,500 OBO. 920-795-4754. (P3)

New 3400 gallon tank, never used, 36" manway bottom, 20" manway top, 3" intake, 4" dump, epoxy primered. \$10,000. Delivery available. Other tanks available. 800-721-2774. (P3)

Vacuum tanks, 100 to 6000 gallons. All options available; hatches, primary, secondary, valves, catwalks, ladders, etc. Every-thing needed to build your own septic truck. Choose mild, stainless, or galvanized steel. Ask about full open doors. 800-545-0174. www.tanksandpumps.com. (PBM)

TANK TRAILER

New Presvac 5,500 gallon, carbon steel, DOT, vacuum tank trailer with pump & engine package. (Stock #13325) www.VacuumSalesInc.com, (888) VAC-UNIT (822-8648). (PBM)

2007 new Acro trailer, 7,000 US gallon aluminum vacuum pressure tank. (Stock #13273A&B) www.VacuumSalesInc.com, (888) VAC-UNIT (822-8648). (PBM)

1990 Presvac 5,000, **stainless steel** DOT with pump engine. (Stock #5008) www.VacuumSalesInc.com, (888) VAC-UNIT (822-8648). (PBM)

TOOLS

T&T Tools: Probes, Hooks. Probes feature steel shafts with threaded and hardened tips. The insulated **Mighty Probe™** tested to 50,000 volts. **Top Poppers™** open manhole covers easily. Free catalog. www.TandTtools.com. Phone 800-521-6893. (CPBM)

Crust Busters - Portable, lightweight machine guaranteed to mix up septic tanks and grease traps! Save time and money! www.crustbusters.com, 1-888-878-2296. (PBM)

TOYS

Septic pumper and vacuum die-cast toy trucks in your choice of colors and logos. Several cabs available. Call 877-450-2100 or write to Granite State Collectibles, PO Box 440, New Ipswich, NH 03071. (PBM)

TRAILERS VACUUM/TANKER

1993 Presvac 5,800 gallon steel vacuum tank trailer. Asking \$15,500. Call 1-716-432-2885. (P3)

TRUCKS\DELIVERY

1985 Mack DM600, 6-spd, cab replaced, 4000 gallon tank, 3 valves, Moro A-C4 pump, 1-15,000 lb. Bethlehem Mfg. mountrail bed, 18' bed, 10' boom, double post on back. 252-491-2321. (P6)

TV INSPECTION

2001 Chevy Cube Van, white with 48,000 miles, with roof top AC, Aries pan/tilt camera with two tractors, 550' of cable, DVD or VHS. Call 641-660-6991 or 641-673-9377. (P5C6)

Must see! 2 X Envirosight camera systems 2005 pan-and-tilt camera 4X digital zoom Rover 100 steerable crawler 4-12" automatic motorized reel PCU with monitor, text generator, footage counter. Portable or truck installation. Serviced and inspected Envirosight. 613-227-8659. (CP4)

TV Inspection Equipment: 3 RST inspection vans, PipeTech software, 1 Vactor. \$75K OR BEST OFFER. WWW.PICS-LLC.COM. 615-347-9021. (CP3)

TV INSPECTION

2001 Aries Saturn 3 Pipeline Video Inspection System mounted in an enclosed trailer. VC-3000 video capture system, TR-2000 camera transporter 6' to 30", 1200' reel/winch with level wind, PE-1111 pan & tilt camera with aux. lights. Misc. skids, poles, tiger tales, emergency repair kit. Unit is ready for work. PRICED TO SELL \$9,999. 715-967-2838 or 1-866-203-2033. (P5)

2003 P-448 PEARPOINT STEERABLE TRACTOR with power scissor lift, 18" to 72" pipe, S/N 448-063. Complete w/accessories. \$25,000 OBO. Dale or Mark 269-381-2400. (CMPBM)

1998 Cues TV grout unit, 34,880 miles, color camera, diesel, generator. 972-938-1905. www.empireequip.com. (CPBM)

Aries TV sewer inspection system, pan & tilt, on tracks, color, in 1993 Ford E350 box van, roof air, 7.3 diesel, 80K miles, Martin diesel generator 7.5 kw, TV, VCR, 3 units available. Call or email for more info and pictures. We can ship to any location. Very nice City owned trucks. Asking \$29,950 ea. Call 573-374-8785 or email elitemotors@charter.net. (CP4)

VACUUM LOADERS

1989 series 2000 Vactor vacuum box, excellent condition, auger from bag house, hydraulic boom, photos available upon request. \$5,000. 204-633-4879. (CP5)

1982 Ford Vactor unit, wet-dry, 1976 Hend. V6 Detroit, V4 Detroit, vacuum truck; 1970 Hend. V6 Detroit, V4 Detroit, vacuum truck. All in working condition. 806-273-2865. (P3C4)

2000 Vactor 2100 on 2000 Sterling LT9501. All options, list \$330,000 new. Roots 1016 PD blower, 80 gpm/2,500 psi jetter, 1,300 gal. fresh water, debris body flushout, pump off, cold weather recirc., Jake, hydro-ex kit, air purge, hyd. tool option. Only 102,000 miles, 4600 hrs. Tom 719-499-0647. (CP4)

2008 Sterling LT9500 tri-axle with a new Presvac, Powervac 3800, 3,250 gallon US, DOT, wet/dry industrial, vacuum tank loader. (Stock #13294B) www.VacuumSalesInc.com, (888) VAC-UNIT (822-8648). (PBM)

VACUUM LOADERS

2003 Guzzler/Sterling chassis. 147,000 chassis miles, 335/1250 CAT C-10, 10 speed Eaton, 27" Hibon 285. 64K GVW. Good shape. 414-349-3225. (P4)

VANES

Dura Comp 535, high-quality non asbestos vacuum pump vanes. Good to 400°F. Buy factory direct and save. Same day shipment on most models. Juroop, Battioni, Moro, Masport, Fruitland, Demag. Long lasting Dura-Comp 535 pump vanes carry a "Money-back" guarantee. Call us today. Powerflo Products 800-758-4788 or 562-997-0720. (PBM)

American Industrial Components: Our vanes are manufactured from the highest quality laminated materials available and are fabricated to exact tolerances and specifications. Please see our ad in this issue. 800-272-7557. (PBM)

WANTED

WANTED: 2505 Terra Gator Tool Bar, 4 or 5 shank, straight bar, model P-16 Case IH reset style. Ph: Ron @ 204-745-8310. (CPT4)

Looking for 1-1/4" USED 2500 psi sewer cleaning hose, any length. Call 800-235-9704 or 719-541-2967 or email: canamgeothermal@fairpoint.net. (P3)

Water jetting equipment. We rent, sell and repair water blasters. Visit us at: www.waterjettingequipment.com or phone 714-259-7700. (CPBM)

WATERBLASTING

Wanted to Buy: Vactor 2100s and late model Guzzlers. Cash. Phone 800-336-4369. (CPBM)

1987 NLB 20250, 1989 NLB 20250, 1996 NLB 15600, 1995 NLB 10200, 1987 NLB 10150. Call for pricing and pictures 330-270-9900 ext. 3. (P3C4)

Flexible lancing machine, Freelance MK5 Model #07-95, serial #FL5-1016. Call for information. 330-270-9900 ext. 3. (P3C4)

It's **EASY** to submit your classified **ONLINE!** Just go to:

www.pumper.com

Only
\$1.00
PER WORD!

CLASSIFIEDS

Place A Classified Ad

Fill in the **Online Classified Ad Blank!**

PLACE YOUR AD ONLINE AT www.pumper.com - IT'S ALWAYS THERE TO MEET YOUR BUSY SCHEDULE



Get Results!

Advertise in **CLASSIFIEDS** for only

\$1.00 per word!
(\$20 min.)

**MUNICIPAL
SEWER
WATER**

Cleaner

Pumper

CLASSIFIED AD FORM

PRO

**ONSITE
installer**

Please print ad legibly below with *correct punctuation* and *phone number*. Circle each word to be bolded, if any. (\$1.00 extra per word)

CHOOSE THE CATEGORY:

- | | | | | | |
|------------------------------------------------------|-------------------------------------------------|---------------------------------------------------|----------------------------------------------|---------------------------------------------------|-----------------------------------------------------|
| <input type="checkbox"/> Aerators | <input type="checkbox"/> Dredges | <input type="checkbox"/> Levels & Transits | <input type="checkbox"/> Positions Wanted | <input type="checkbox"/> Root Control | <input type="checkbox"/> Trailers- Vacuum/Tanker |
| <input type="checkbox"/> Blowers | <input type="checkbox"/> Excavating Attachments | <input type="checkbox"/> Locators | <input type="checkbox"/> Pressure Washers | <input type="checkbox"/> Safety Equipment | <input type="checkbox"/> Trucks (dump/septic/misc.) |
| <input type="checkbox"/> Bucket Machines | <input type="checkbox"/> Excavating Equipment | <input type="checkbox"/> Miscellaneous | <input type="checkbox"/> Pumps-Dredge | <input type="checkbox"/> Septic System Components | <input type="checkbox"/> TV Inspection |
| <input type="checkbox"/> Businesses | <input type="checkbox"/> Hand Tools | <input type="checkbox"/> Parts & Components | <input type="checkbox"/> Pumps-High Pressure | <input type="checkbox"/> Septic Tanks | <input type="checkbox"/> Vacuum Loaders |
| <input type="checkbox"/> Business Opportunities | <input type="checkbox"/> Hazardous Waste Units | <input type="checkbox"/> Pipeline Rehabilitation | <input type="checkbox"/> Pumps-Submersible | <input type="checkbox"/> Septic Trucks | <input type="checkbox"/> Vanes |
| <input type="checkbox"/> Cable Machines | <input type="checkbox"/> Hydroexcavation | <input type="checkbox"/> Portable Toilets | <input type="checkbox"/> Pumps-Vacuum | <input type="checkbox"/> Service/Repair | <input type="checkbox"/> Vehicle Tracking |
| <input type="checkbox"/> Computer Software | <input type="checkbox"/> Jetters-Trailer | <input type="checkbox"/> Portable Toilet Tanks | <input type="checkbox"/> Pumps - Washdown | <input type="checkbox"/> Slide-In Units | <input type="checkbox"/> Wanted |
| <input type="checkbox"/> Dewatering | <input type="checkbox"/> Jetters-Truck | <input type="checkbox"/> Portable Toilet Trailers | <input type="checkbox"/> Pumps-Water | <input type="checkbox"/> Sludge Applicators | <input type="checkbox"/> Wastewater Transfer |
| <input type="checkbox"/> Drainfield Restoration | <input type="checkbox"/> Jet Vacs | <input type="checkbox"/> Portable Toilet Trucks | <input type="checkbox"/> Rodding Machines | <input type="checkbox"/> Tanks | <input type="checkbox"/> Waterblasting |
| <input type="checkbox"/> Drain/Sewer Cleaning Equip. | <input type="checkbox"/> Lease Financing | <input type="checkbox"/> Positions Available | <input type="checkbox"/> Roll-Off Containers | <input type="checkbox"/> Tools | |

CHOOSE THE PUBLICATION(S): (Deadlines are for the month preceding issue)

- | | | |
|-------------------------------------------------------------------------------------------|---------------------------------------------------------------------------------|--------------------------------------------------------------------|
| <input type="checkbox"/> CLEANER
Deadline: 1st of the Month | <input type="checkbox"/> PUMPER
Deadline: 10th of the Month | <input type="checkbox"/> PRO
Deadline: 17th of the Month |
| <input type="checkbox"/> MUNICIPAL SEWER & WATER
Deadline: 1st of the Month | <input type="checkbox"/> ONSITE INSTALLER
Deadline: 17th of the Month | |

CLASSIFIED AD RATE:

\$1.00 per word, per month, with a 20-word minimum or \$20.
[\$1.00 extra per bold word (key words only)]

ADVANCE PAYMENT REQUIRED:

No billing for classified ads. Payment must be received in advance before publishing.

CALCULATE THE AMOUNT DUE:

_____ words X \$1.00 = _____ X _____ Publications X _____ Months = \$ _____
(\$20 minimum) # of publications checked above # of months to run the ad Total Amount Due

(Example: 25-wd. ad x \$1.00 per word = \$25.00;
\$25.00 x 2 publications [Pumper & Pro] = \$50.00;
\$50.00 x 2 months to run the ad = \$100.00 Total)

FILL IN COMPANY AND PAYMENT INFO:

COMPANY NAME: _____
 ADDRESS: _____ PHONE: _____
 CITY: _____ STATE: _____ ZIP: _____

MAIL this completed form with payment to:
COLE Publishing Inc., PO Box 220, Three Lakes, WI 54562

FAX this completed form to: **715-546-3786**

ONLINE forms at: www.cleaner.com
www.pumper.com
www.promonthly.com
www.onsiteinstaller.com
www.mswmag.com

QUESTIONS: CALL 1-800-257-7222

PLEASE FILL OUT CREDIT CARD INFORMATION COMPLETELY INCLUDING V-CODE (3-DIGIT NUMBER FOUND BY YOUR SIGNATURE)

CREDIT CARD NO.: _____ V-CODE: _____ EXP. DATE: _____

CARDHOLDER NAME: _____ PHONE: _____

WE ACCEPT:

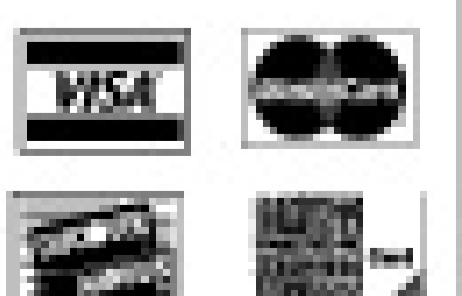

Classy Truck of the Month



Steve 'O' Septic Monticello, Minn.

Owner Steve Langanki bought this 2000 Sterling LT 9501 in 2007 when he started his pumping business. The truck, bought from Glen's Truck Sales, was previously used as a lumber hauler. Langanki shortened the frame by 54 inches, then had it converted for pumping at Engle Fabrication Inc. in Sauk Centre, Minn. The truck sports a 3,300-gallon steel tank with HXL400WV Masport pump with fully coated hose trays and heated collars. Power is provided by a 310-hp C10 Caterpillar engine coupled with a 10-speed Eaton-Fuller transmission. The truck was painted a dark metallic blue by Engle. Custom lettering and logo were done by Jeff Hoglund Sign. The no-frills chassis has no chrome accents and the interior is basic, with only air conditioning and air-ride seats. The truck carries a Schmitz Bros. Crust Buster. The truck is used mainly to haul residential septic waste.

Show us yours!

Got a truck with real WOW appeal? Show it off to Pumper readers — and to the whole world through www.pumper.com!

Send photos of your truck after it has been lettered with your company name, and please pose the owner(s) with the truck. Any industry-related truck is acceptable. Please limit your submission to one truck only.

Your submission must include your name, company name, mailing address, phone number, and details about the truck, including tank size, cab/chassis information, pump information, the company that built the truck, and any other details you consider important. In particular, tell us what features of the truck help make your work life more efficient and more profitable. E-mail your materials to editor@pumper.com or mail to Editor, Pumper, P.O. Box 220, Three Lakes WI 54562. We look forward to hearing from you!



Comforts of Home

Services, Inc.

LUXURY TRAILER SALES



- Lowest Interior Floor Height in the Industry
- ADA wheelchair accessible units.
- Unlimited Floor Plans from 8' to 53' Trailers
- Rigid Steel Shell Construction from top to bottom to resist rot and warping.
- Specializing in Customizing trailers to fit your needs.
- 24/7 Tech Support for the best customer service available.



- Free Nation Wide Lead Program for our customers.
- Easy Fold-Up Steps & Door Handles
- Large Capacity Waste Tanks
- High Privacy Partitions are Standard for Added Comfort
- Rigid Platform, our smallest wide body trailers start out with Dual 10" ASTM I-Beams.

Starting at \$13,400 with A/C, Heat, HD Steps and a Large 300 Gallon Waste Tank

See our website for more layouts and prices



8' starting at \$13,400
w/A/C & Heat - 300 gal waste



12' starting at \$21,300
w/A/C & Heat - 450 gal waste
Includes Showers



20' starting at \$29,900
w/A/C & Heat - 600 gal waste



24' ADA starting at \$35,600
w/A/C & Heat - 750 gal waste

INFO@COHSI.COM • 877.382.2935 • WWW.COHSI.COM

90 DAY JETTER TRIAL

Plumbers - Let us improve your bottom line



13HP
4000 PSI **\$1,949**

Free Freight
COMPLETE DETAILS AT
www.amazingmachinery.com

1-800-504-7435

Aluminum Vacuum Tanks

ALUMATANK

progress.tank.com

PORTAVAC

Septic & Restroom Service

Refrigerator MAGNETS

500 Minimum -
Call for pricing



43¢ EACH!

Actual Size: 4" x 1-3/4"

2-color Imprint - Quantity Discounts

Marketplace Advertising

DYE TRACERS

Solutions for:

- Infiltration
- Septic Systems
- Cross Connection
- Leaks and more...



BRIGHT DYES

Division of Karygate Chemicals

www.brightdyes.com • FAX: 937-886-9300

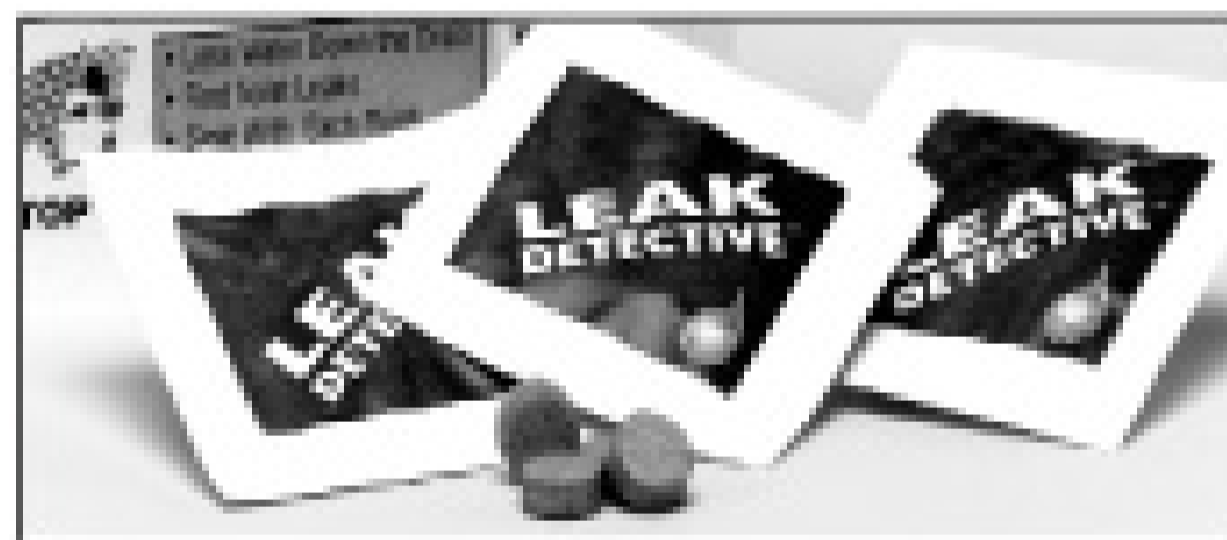

FREE SAMPLE 1-800-394-0678

AERRATECH

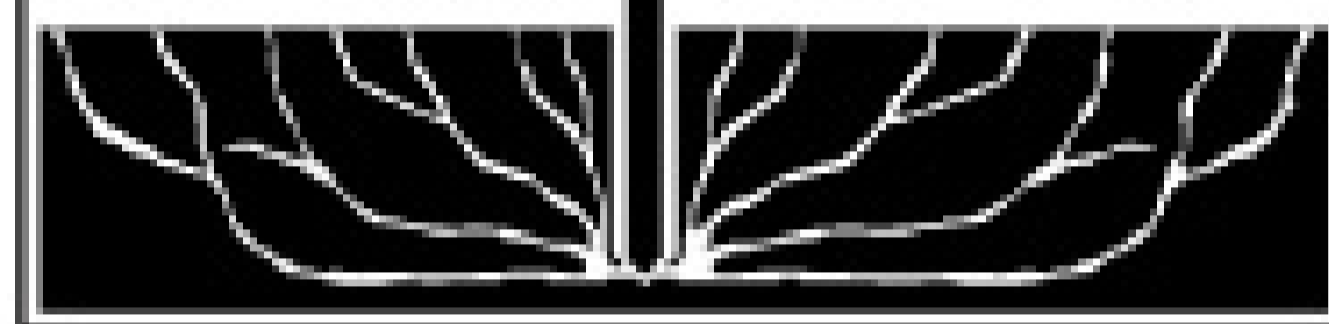

Aerratech, LLC.

NEW AND USED
Terralifts

All parts available

Sales: 603 253 4774

Parts and Service:

888 298 4272

T&T TOOLS **T&T Tools**
800-521-6893

800-521-3260 FAX

E-mail sales@tandttools.com • www.tandttools.com

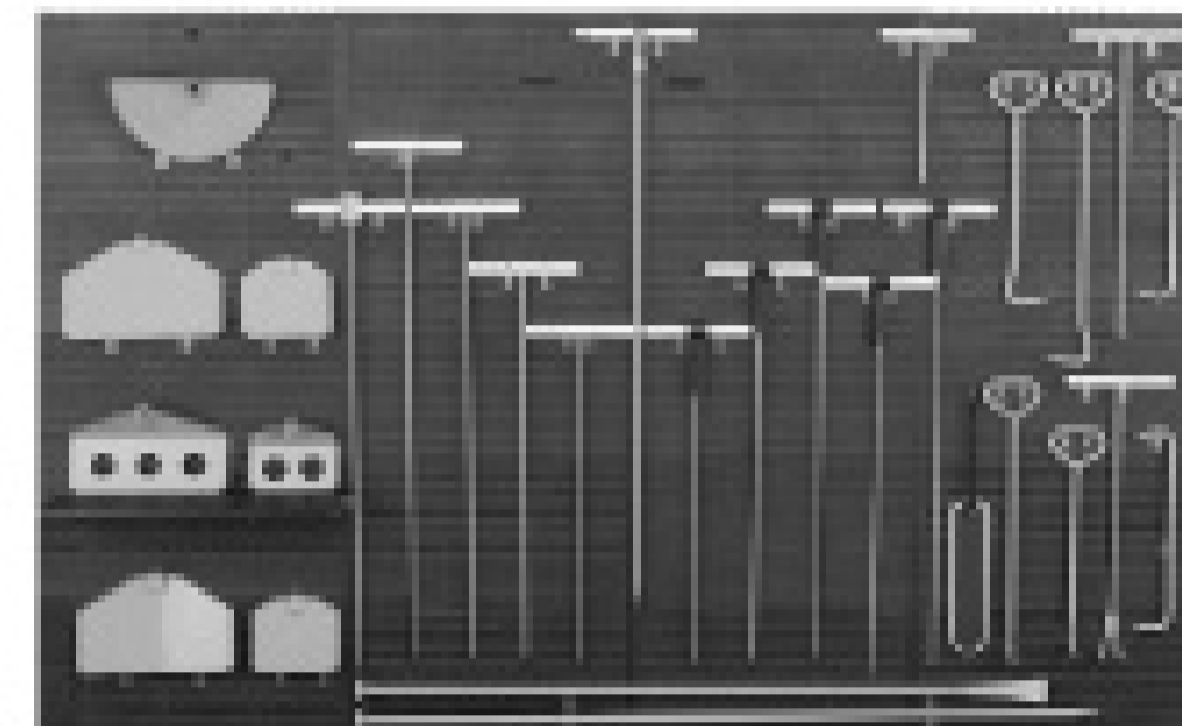

Mighty Probe™
Sludge Hoe™
(insulated)
Sludge Spud™
Manhole Hook
Tommy Hook™
Striking Head™

Handy Hook™
Water Probe
Curved Spud™
Top Popper™
Ground Buster™
Smart Stick™
(standard)

www.tandttools.com



2002 International 4400

with 139,801 miles, VIN:
1HTMKAAN92H533662, with Abernathy 2,500 gallon septic pumper unit S/N: 2500083100PNR102

CENTER CAPITAL CORPORATION®

A Subsidiary of Webster Bank, N.A., Member FDIC

Asking Price: **\$37,500.00**

Contact: Stephen Krzanowski

Phone: **860-409-2924**

SEPTIC ODOR PROBLEM?

ODORHOG™ Charcoal Activated Vent Pipe Filters Remove Sewer & Septic Odors from Plumbing Vents



Patent Pending

ODORHOG™ Filters Come in 5 Standard Sizes or Any Custom Size You Specify
SAME DAY SHIPPING & PRIVATE LABELING AVAILABLE

A&M BIO-FILTER, LP
1.800.963.6746
www.odorhog.com

30% OFF FOR ALL ORDERS OVER \$2000

"You're going to WORK, not WAR!"

ARE YOU STILL USING A HOOP OR PICK AXE TO REMOVE SEPTIC TANK COVERS? NOW THERE IS A BETTER WAY!

Eliminate back injuries with BigsEasyLift

Call for a FREE 30 Day Trial

phone: 866.926.5438
fax: 866.271.9057
email: info@BigsEasyLift.com
www.BigsEasyLift.com

BIGS EASY LIFT

Simple Solutions
DISTRIBUTING LLC

We Stop The Stink Guaranteed!
Budget Conscious Solutions for Wastewater Odor Control.

ODOR ADSORBERS FOR: • Manhole Openings
• Lift Station Vents • Plumbing and Septic Vents
• Large Industrial Applications

Mention this Ad and Save 10%!! 20% on orders over \$2000!!

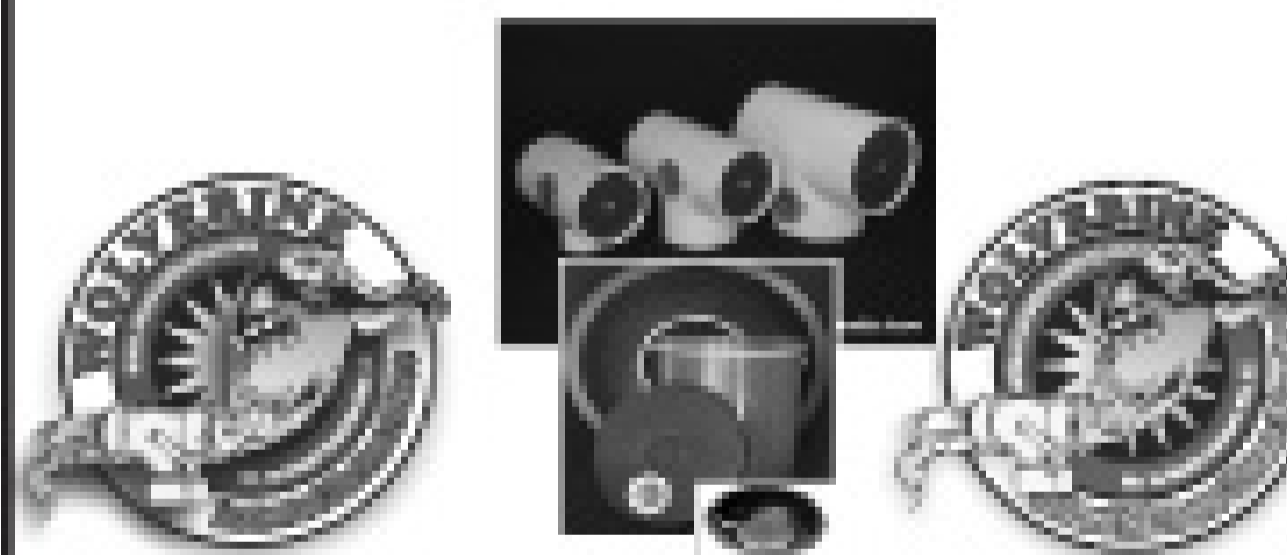

973-846-7817 or
866-667-8465

www.IndustrialOdorControl.com
www.StopSepticOdor.com

Thank you for visiting us

NEED GLOVES?

- 14" Gauntlet
- Plastic Coated
- Sandpaper Finish Grip
- Jersey Liner
- One Size Fits All

\$35 PER DOZEN \$189 FOR A DOZEN

TO ORDER, SEND A CHECK/MONEY ORDER OR CALL US TOLL FREE! Make checks payable to: ADVANCE GLOVE CO. Please include UPS shipping address

Major Credit Cards Accepted!
ADVANCE GLOVE CO.
80, BOX 149 • LEMMON, MI 48449
100-YEAR: 1.800.323.1223

DISCOUNT ALUMINUM

SHEET, COIL, PLATE

3003/5052/
5454/5083/5086
AND MORE

20 MILLION POUND INVENTORY

ARE YOU PAYING TOO MUCH?

1-888-540-0066
ASK FOR JAYSON

FAX:
440-286-2229

E-MAIL:
capitaluminum@msn.com

Kwikk-Lokk
 Vacuum Truck
 Couplers and Hose.
www.kwikk-lokk.com
(814) 899-3644

PIT HOG PUMPS
 WASTE

LWT manufactures
 manned and remote
 controlled lagoon
 dredges and pumps.
 Rental dredges also
 available.



LWT LIQUID WASTE
 TECHNOLOGY.
 Box 250, 422 Main St., Somerset, WI 54025
www.lwtpithog.com / 1-800-243-1406

**THE LEGENDARY
 SEPTI-MARKER**

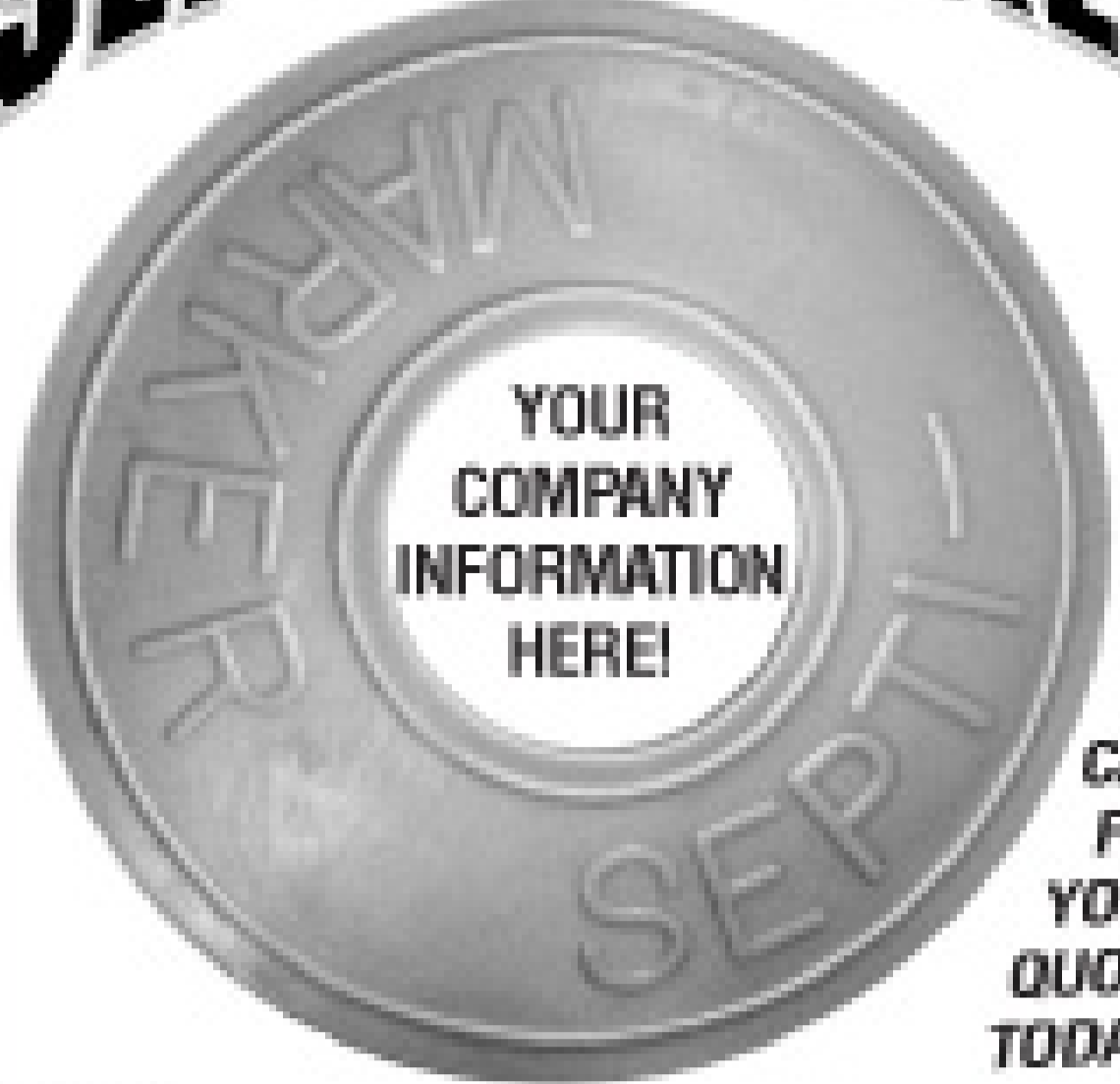

CALL FOR
 YOUR
 QUOTE
 TODAY!

PLANT YOUR
 BUSINESS CARD

WORKS AS A
 BUSINESS CARD
 AND TANK LOCATOR

**HOW
 DOES
 IT WORK?**

1. ORDER YOUR MARKERS
2. ASSEMBLE MARKERS (2 PCS)
3. LEAVE IN CUSTOMER'S YARD
4. MAKE MONEY!!

ALCSA 1.800.537.5800

PADLOCKS

- Your Padlocks
- Your Key Number
- Any Quantity
- Best Prices

**Quick-Shipped
 Anywhere!**



Master

SERVING THE
 PORTABLE SANITATION
 INDUSTRY FOR
 14 YEARS—
 WE'RE THE
 BETTER WAY
 TO BUY PADLOCKS™

**Call For FREE
 CATALOG
 or Instant
 Quote!**

LockMasters
1-800-461-0620
www.lockmastersusa.com
 sales@lockmastersusa.com • Fax (850) 914-9754

**WATER
 JETS** FOR RENT



- Units from 4,000 to 40,000 psi, including convertibles
- 60-600 hp, diesel or electric
- Rent, buy or lease
- Branches in MI, TX, NJ, CA, LA

NLB Corp. 1-877-NLB-7996
www.nlbcorp.com



Marketplace
 advertising

1.800.257.7222

Deadlines:
 Pumper: 10th of the month*
 *PRECEEDING ISSUE DATE

Pumper

Pumper Marketplace gives you nationwide exposure to thousands of industry professionals. **Now Available In 4-Color**

Layout and design is included **FREE**, and we can fax or e-mail you a proof for final approval!

Choose a size that works best for you!

Size A: \$309^{00*}	Size B: \$209^{00*}	Size C: \$109^{00*}
1.875" w x 4.875" h	1.875" w x 3.2" h	1.875" w x 1.5" h
This size is great for 2 photos!	Perfect size for one photo!	A great value!

*Black and white prices, call for 4-color pricing.

[Send ad materials and payment to:
 COLE PUBLISHING INC. • P.O. BOX 220 • THREE LAKES, WI 54562]

Mobile Dewatering Service



Municipal & Industrial Sludge Digesters, Lagoons, Ponds, etc.

- Double Belt Filter Press
- Up to 25% Drier Cake
- Professionally Staffed
- US & Canada

Fluid Technology, Inc.
 P.O. Box 937, Oxford, OH 45056
 Phone: 513-981-7808
 E-mail: sales@fluidtechinc.net
 Web site: www.fluidtechinc.net

EASILY MOVE RESTROOMS

- ✓ Aluminum Frame
- ✓ Ships UPS
- ✓ Carry ADA's
- ✓ Models starting at \$380



Available with 2, 4, 6 or even 8 wheels and your choice of air or solid foam tires.

Super Mongo Mover®

DA
Deal Assoc. Inc.
www.dealassoc.com
866.599.3325

WATER CANNON 1-800-333-9274
www.Jettersonline.com

Pressure Washers

HONDA @ 2700PSI \$377
HONDA @ 3000PSI \$416
HONDA @ 4000PSI \$859

We Customize high pressure pumps

Honda Engines

5Hp GC **\$199**
 6.5Hp GX **\$349**
 8Hp GX **\$459**
 9Hp GX **\$489**
 18Hp GX **\$1,099**

BEST Sellers ALWAYS on Sale

5.6GPM @ 4000PSI **\$399**
 8.0GPM @ 3500PSI **\$499**
 7.0GPM @ 5000PSI **\$599**



Call For Free Quotation.
 We Also Stock Pumps With Left Hand Drive, Tapered Shaft, Car Wash Duty, 316 Stainless Steel and Unique Applications
1-800-964-9274

Water Cannon - 5 Offices Nationwide, Since 1981



ASHLAND PolyTraps

Grease, Oil, Hair and Lint Traps and Interceptors

- NO Rust or Corrosion
- Lightweight
- Very Cost Effective
- Sizes up to 560 Gallons
- Made in the U.S.A.!

LIFETIME WARRANTY!

Certified by U.P.C., IAPMO and P.D.I.

800-541-8004
PolyTraps@Amplex.net

One Complete Package

cleaner.com constructionguide.net
 promonthly.com pumbershow.com
 mswmag.com pumpertrader.com
 pumper.com septicyellowpages.com
 onsiteinstaller.com sewerpages.com

Cole Publishing
1.800.257.7222 • 715.546.3346

WWW.ROOTERMAN.COM



Franchises available with low, flat fee
 New concept. Call 1-800-700-8062.

FRANCHISE PACKAGE \$7,950.



Pumper Dig into our pages.

What you learn on these pages could be worth \$1,000s. It's all yours for \$1 a month*. That's right. Some 25,000 of your industry peers welcome **Pumper** every month for the value it brings to their business. Each issue shows you:

- > New tools to help you win jobs and earn more profit.
- > Ways to save on office expenses, supplies, advertising, taxes.
- > Money-saving deals on equipment.
- > And much more.

Best of all, you'll learn from other successful business owners – how they did it, and how you can, too.

Don't miss an issue – subscribe today!

800.257.7222
 www.pumper.com

*Subscription Rates: 1-year \$16, 2-years \$26, 3-years \$36 for domestic deliveries

Pumper

see photos in COLOR at www.pumper.com

TRUCK STOP



March



1995 Ford Auromax: 330 hp Cummins, 9-spd., new 3500 gal. tank and Jupop R260 364 cfm vac pump, new paint, very nice truck.....\$39,000

877-898-5104
hullstruckbodies.com

P3



2006 Mitsubishi FE180 Portable Service Truck: 1,200 gal. stainless steel tank, 850 waste, 350 fresh, 68,000 miles, full warranty, like new.\$54,000

501-513-2543

P3



2004 VacCon International: 827 Roots, 1300 gal. water, 12-yr. tank w/high dump, 80 gpm @ 2000 psi.\$225,000

Call Mike 772-216-4020

P3



2000 International Septic Tank Pump Truck: Rig approximately 2 years old, 3500 gallon tank, runs daily.\$35,000

205-841-3060

P4



2007 International (Pre-Emission) DT 466 - 4300: Air brakes, auto. Allison trans., stainless steel tank, 1100 waste, 400 fresh, Conde pump, 43,000 miles, excellent condition. Built by Best Enterprises. ..\$69,900

417-257-4088

P3



2000 Vac-Con Combo: 52,684 miles, 13 cu. yd. debris body, 80 gpm @ 3000 psi, 10' telescopic boom, articulating front hose reel.

Call Mike Thomas at 1-800-222-3686

www.2sei.com/html/a_715_10.html

OMP3



2006 Ford F-550 4x4: 875 gal. (300 fresh/575 waste) Imperial tank w/2-place toilet carrier. Diesel, auto, air, XL pkg. Excellent condition. Only 61,300 miles.\$48,995

Call 800-722-7382

Commercial Sales

P3



1984 GMC Camel Jet: 210 hp 3208 CAT, 1500 gal. water @ 80 gpm, pump @ 2500 psi, 9-yr. debris box w/5000 cfm Roots blower.\$8,000 OBO

814-825-6000

P3



2000 Kenworth: Cummins 330 hp diesel, 10 spd., air suspension, 3500 gal., 367 Challenger pump, PTO driven jetter, heated valves.\$43,500

Call NY - Judge Coleman

516-398-5638

P3



1997 Ford LN 8000 Vac-Con: Low miles, Allison trans., 3-stage fan, 12-yr. debris, 1500 gal. fresh water for jet, 30 gpm @ 2500 psi. Well maintained, ready to work.Price Reduced to \$51,500

Call Don 954-943-9100

P3



2000 Freightliner FL70 Pump Truck: Cummins 210 hp, 6-spd., single axle, Moro pump, 2,000 gal. tank, diamond plate tool box, AC.....\$34,000

269-684-2580

P3



1999 International: T44 diesel, 6-spd., Coleman PSB 950 stainless steel 3-compartment, hot wagon wash system, 150 pump, dual unit carrier.\$31,500

Call NY - Judge Coleman

516-398-5638

P3



1988 Ford L800: Ford diesel, 2200 gallon tank, runs and pumps good, great starter truck.....\$12,000

205-841-3060

P4



1999 Sterling: Cummins engine w/warranty, 8-LL trans., 4,500 gal. Jay's tank w/ Battioni 720 pump, Berkley irrigation system, cold weather unit. Located in Wisconsin.....\$75,000

800-872-2915

P3



1999 Freightliner: Air, cruise, 10-spd., 215 Cummins, airtag, new rubber, like new, 3250 tank, Masport liquid cooled pump, 160,000 miles, mint condition.\$54,000

989-743-5055

P3



1995 Mack Septic/Great Pump Truck: 5-spd. trans., 3,200 gal. tank, new Demag/Wittig vac pump truck. Looks and runs excellent.\$38,500

561-753-3446

P3

PLACE YOUR AD ONLINE AT www.pumper.com - IT'S ALWAYS THERE TO MEET YOUR BUSY SCHEDULE

Pumper TRUCK STOP

see photos in COLOR at www.pumper.com



March



Shower and Restroom Trailers: Platinum and Gold Series, new and used available. Each with separate men and women sides.

CCI/Brian Touey 805-896-3777 PBM



2005 F550 4X4 Diesel: 6-spd., XL package, H2 Masport pump, 950 gal. tank, 600 waste, 200 chemical, 150 fresh, 2-place toilet rack, 75,000 miles.....\$37,500
Call Ryan at 801-430-7287 P3



1994 Vactor 2110/1995 International 2554: 10-yd. debris body, 1,000 gal. water, 8' telescopic boom, rotating hose reel, dual roller wind guide, hot shift PTO, fuel/water separator. (Stock 1452)
Call Joe 312-208-6373 P3



Vactor 2110 Mounted on a Ford L8000: Fold-down pipe racks, debris body flush-out. Call for many other options not listed. (Stock 1453)\$32,500
Call Joe 312-208-6373 P3



2001 International Septic/Grease Pump Truck: Cummins 400 hp, 8-spd. trans., Presvac 4200 gal. w/200 gal. fresh water for Harben jetter. 4000 psi, 300' jet hose, 400 cfm Demag vac. pump.
.....Price Reduced to \$59,500
Call Don 954-943-9100 P3



1999 Vactor 2100 on a Sterling Chassis: CAT 3126 engine, Allison auto. trans., 80 gpm @ 2500 psi, accumulator, debris body flush-out, 4' extend. boom, fold-down pipe rack. (Stock 1445)
Call Joe 312-208-6373 P3



2005 International: 4000 Series, Model 4300, DT 466, 6-spd., H4 Masport pump, 1500 gal. tank, 1000 waste, 150 chemical, 350 fresh, 2-place toilet rack, 88,000 miles.\$42,000
Call Ryan at 801-430-7287 P3



2004 Sterling Aquatech B-10 Sewer Cleaner: 300 hp, 62,195 miles on truck, 824 Roots blower, 2000 psi, 80 gpm General pump.\$150,000 OBO
Call Javier at 786-402-3092 CP3



2007 Sterling Cab: With 3600 gallon aluminum P/V tank with Juro-Pak R260.
.....\$116,000 including FET
800-722-8384 PBM



1981 Ford 8000 Vactor/Jet Rodder: 3208 Cat, 13,637 miles, Pony motor, 300 CID Ford engine, only 101 hrs., like new.
.....\$28,500 OBO
401-727-8600 P3



IN PROGRESS 2007 Freightliner M-2: 250 hp Cat, 6-spd. manual, 18,000 miles, full factory warranty, NEW 2500 gal. vac. body, Masport HXL400WV vac pump, 2 manways, 3 sight eyes, 4" discharge, 3" inlet, painted to suit.\$67,000
Call Terry 734-777-0390 P3



1996 International DT-466: 33,000 GVW, new 2100 gal. LMT vac. tank, 20' manways, Masport HXL 75WV water cooled pump, heated valves 3" & 4", LED lights.
.....\$28,000
Call Tim @ LMT 1-800-545-0714 P3



1995 Guzzler Vac Truck: 28" H.G. liquid ring vac pump, new tires, new paint, great running truck.....\$80,000
609-332-4149 CP3



O'Brien 3510-FC: Brand new 9 hrs of operation, with beacon light washdown gun and wireless control. 350 gal poly. tank, electric reel oversized high-torque motor, Giant-triplex pump 10 gpm @ 2,500 psi Honda engine twin-cyl. electric start high-impact thermoplastic sewer hose 400'.
786-439-9593 P3



1990 Dodge 1-Ton & 1985 International Pumper 2,000 Gal.: Both run great and are working, need some work, great for starting in the pumping business. Package deal.....\$18,500
814-277-6227 P3



2000 International 4900 Nearing Completion: DT466/225 hp, manual trans., NEW 2500 gal. vacuum body, Masport 400 cfm vac. pump, 24"x24"x60' alum. tool box, 100' 3" suction hose.\$39,400
Call Terry 734-777-0390 P3

Pumper TRUCK STOP

see photos in COLOR at www.pumper.com



March



1999 IHC 8100: New 2500 gal. carbon steel tank, new NVE pump package, 6' dump, 4" inlet, 36" rear manway, Cummins M-11 350 hp, standard trans., 32,000 GVWR.....\$41,250

352-323-6284 X 201 P3



2000 US Jett 10K and 4K: 600 gal. tank, 100 hp Deutz, 747 hrs., mounted in 14' heated box on a 2000 Chevy 6500, 45K, Cat dsl., excellent condition.

641-673-9377 or 641-660-6991 CFBM



1979 Mack RS612LT: E6 2-valve 315 hp, 10-spd. Eaton Fuller, 2500 gal. tank, Masport H75W, air ride, water tank, tool boxes, aluminum/steel wheels, recently painted, 90'-3" hose. Just serviced!!

.....\$18,500 OBO
Call Stanley @ 360-701-8516 P3



1996 GMC W7 Keith Huber Unit: 3-compartment 900 waste 300/300 fresh, DC-10 washdown pump, 2-unit rear carrier, 123,000 miles.\$20,000 OBO

269-435-4611 - Constantine, MI P3



1991 Freightliner: 3176 Cat, 275 hp, 9-spd., A/C, spring ride, 2500 gal. tank, Moro vac pump. Tank 7 years old, new paint cab and chassis.\$24,000

877-898-5104
hullstruckbodies.com P3



2002 FL60 Freightliner: 180K miles, 3126 Cat motor, new clutch, trans., A/C compressor. 1500 gal. waste, 200 gal. water, new MEC 8000 pump. Lots of extras. Please call!\$47,400 OBO

830-560-0021 P3



2000 Freightliner FLD 112: C-10 CAT 370 hp w/Jakes, 10-spd., 12 FA/40 RA air-leaf susp., new 80 BBL vac tank with new 350 cfm liquid cooled Wallenstein vac pump. Excellent condition and ready to work. Only 370,000 miles!!\$61,500 OBO

303-772-4019 P3



1999 F-450 Toilet Service Unit: Fresh water washdown pump, newer brakes, pump and tires, new aluminum tool boxes. Will paint to suit.

Call Terry 734-777-0390 P3



1997 Vactor 2110: 6055 hrs. on 1997 Ford, 27,974 miles, needs aux. trans., new 600' hose, rebuilt rear jetter pump, 10 cu. yd. debris tank, 1,000 gal. water tank.

.....Best Offer
860-289-7555 P3M4



2002 International: DT366 engine, 6-spd., non-CDL, new 2000 gal. tank and Jupop PN84 vac pump, new paint and tires, looks like new inside and out.\$29,500

877-898-5104
hullstruckbodies.com P3



2000 International: 800 gallon waste, 250 water tank, new pump, 2-unit carrier, 110K. Located in MD.....\$16,500

Call Doug @ 410-310-5151 P3



1990 Ford Tri-Axle Pump Truck: 350 Cummins, 8LL trans., 5,000 gal. tank, heated valves, 6' dump valve. Good condition.\$21,500

800-858-3111 P3



2006 F-350 Gas 4x4: 10,000 miles (factory warranty), 225 waste, 100 fresh, Battioni pump, DC-10 washdown, 5.5 Honda, 8-toilet trailer, 10 toilets, 1 hand sink, 1 carrier.....\$37,000

315-375-7867 P3



1993 Isuzu NRR: 400 waste, 400 fresh, DC-10 washdown pump, 2-unit rear carrier, 236,000 miles.\$10,000 OBO

269-435-4611 - Constantine, MI P3



1996 Ford L8000 Septic Pumper: 2,500 gal. Boyd tank, Masport pump, heated valves, 63K miles, 33K GVW, Ford/Cummins 8.3L diesel, 6-spd. trans., A/C. Located in Scituate, MA 02066. ..\$32,900

781-545-2596, 617-697-2607,
617-697-2606 P4



1999 Hino: 650 gallon waste, 250 water tank, 170K. Located in MD.\$15,000

Call Doug @ 410-310-5151 P3

Pumper see photos in COLOR at www.pumper.com TRUCK STOP



March



2000 International 4700: DT466, A/T, A/C, P/S, 400 gal. waste, 200 water, 8' x 8' deck for toilets w/electric lift gate.\$37,500

Brian: 509-525-9410

Email: info@randystruck.com P3



1993 Mack c/w Cosco Mastervac: Wet/dry, 5300 cfm blower, with pump off, full opening rear door, full dump, dual bag-house, hose trays, boom, PERFECT.

.....\$90,000

Call Jason 416-509-5520 P4



1995 Peterbilt Model 379: 425 hp with 1980 Reliable 8,000 gal. aluminum tanker. Both mint condition. Ready to haul.

.....\$50,000

603-731-3212 P3



1995 International 4700: T-444, A/T, A/C, P/S, 800 gal. waste, 700 water, supply boxes, fold-down 2-place toilet rack.

.....\$19,000

Brian: 509-525-9410

Email: info@randystruck.com P3



2002 Mud Dog Freightliner Hydro-Excavation Truck: 27" vacuum, 87,032 miles, 3,739 hours on blower (rebuilt @ 2,500 hrs.), water pump recently rebuilt.

.....\$175,000 OBO

Call Malcolm 307-787-6333 PBM

BE ONLINE AND IN PUMPER AND PUMPER TRADER FOR ONLY \$125! JUST FILL OUT THE FORM BELOW, OR GO TO www.pumper.com OR www.pumpertrader.com and fill in the online form!

BE ONLINE & IN PUMPER, CLEANER OR MSW FOR ONLY \$125!

Please print ad legibly with correct punctuation and PHONE NUMBER. Don't forget to send photo!

RATE \$125 PER AD, PER MONTH, PER PUBLICATION WITH A 30-WORD MAXIMUM – **PLEASE NOTE:** You can only advertise **ONE TRUCK** for sale per ad.

DEADLINES **PUMPER: 10TH OF THE MONTH • CLEANER & MSW: 1ST OF THE MONTH** – For example: Jan. 1st would be the deadline for Feb. Cleaner.

ADVANCE PAYMENT **NO BILLING FOR TRUCK STOP ADS.** Payment must be received in **ADVANCE** before publishing.

Enclosed is \$ _____ for _____ ad(s) to run _____ month(s) in

PUMPER/Pumper Trader **MSW** **CLEANER** **ALL 3 PUBLICATIONS (TRIPLE DOLLAR AMOUNT)**

Company Name _____

Address _____ Phone _____

City _____ State _____ Zip _____

• **MAIL** this completed form with payment and photo to:
COLE Publishing Inc., P.O. Box 220, Three Lakes, WI 54562
(Make check/money order payable to: COLE Publishing Inc.)

• **ONLINE** ad form at: www.pumper.com; www.pumpertrader.com,
www.cleaner.com, www.mswmag.com

• **FAX** this completed form to: 715.546.3786 and **E-MAIL** photo to:
truckstop@mswmag.com, truckstop@pumper.com, truckstop@cleaner.com

PLEASE FILL OUT CREDIT CARD INFORMATION COMPLETELY:

CREDIT CARD NO. _____ V-CODE _____ EXP. DATE _____

CARDHOLDER NAME _____ PHONE _____

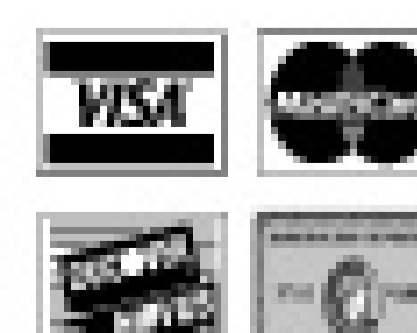

Green since 1959!

For all your Onsite Wastewater Needs



D-Boxes



Heavy Duty Cover and Adapter Ring for Corrugated Pipe



Pump and Filter Alarms



Effluent Filters



Risers



1-800-701-3942

For a Free catalog or to see other products call or visit our website: www.zabelzone.com

PERFORMANCE IS EVERYTHING



IN YOUR DRIVE TO BE THE BEST, WE'RE THERE WHEN YOU NEED US!

When you're in the driver's seat, performance is all that counts.

PolyJohn's high-performance team has everything you need to stay on track and ahead of the competition. Quick response time, products built to last, crowd-pleasing innovations...plus, the best pit crew in the field with our expert area business managers there to personally help you win the race.

Attention Pumper Show racers!

See the final race results, prize winners and how you measured up at www.polyjohn.com

800-292-1305
www.polyjohn.com



EARN MORE • SELL MORE • SERVICE BETTER

PRESVAC

**The Leader
In Vacuum
Technology**

Bright finish Aluminum Tanks
for the Septic Pumping
Industry... Standard
tank models from
2,000 gallons
to 5,000 gallons.



Hydro-Trencher - 5300 CFM air flow/28" HG vacuum
with 8" hydraulic actuated boom, 3000 U.S. gal.
debris tank (stain. steel 316), 1000 U.S. gal.
water tank (stain. steel 316), 9 G.P.M. water
pump with pressures to 5800 p.s.i.

Powervac 5300 for wet/dry operation

5300 CFM air flow/28" HG vacuum, Dump chutes
extended to rear of truck, Stainless steel 316,
DOT 407/412



Liquid Truck

Designed for industrial liquid applications

www.presvac.com

Nationwide Sales & Service
Call a Presvac Dealer in Your Area!

4131 Morris Drive • Burlington, Ontario, Canada L7L 5L5 • Fax: 905-681-0411

905-637-2353 • 800-387-7763