

DEDICATED TO THE LIQUID WASTE INDUSTRY

Pumper

February 2008 www.pumper.com \$5.00 U.S.

DRIVEN TO WIN

2007 Classy Truck
a rolling billboard
for Bainbridge Septic
PAGE 10



**The Buck
Stops Here**
Entrepreneurial Oregon
couple yearns to call
their own shots

PAGE 38



**SHOW
ISSUE!**

Louisville 2008

Feb. 27-29, March 1 MAKE YOUR MOVE



Our Trucks Are Ready. Are You?

Select From Existing Inventory or Build Your Own.

Available Inventory

- 4800 Aluminum Septic Tank
- 3600 Aluminum Septic Tank
- 2500 Aluminum Septic Tank
- 3400 X Ten High Tensile Carbon Steel Front Lift (Full Rear Opening Door)
- 2200 Stainless Steel Premium Septic Tank
- 3200 Stainless Steel Premium Septic Tank
- 3600 Aluminum Septic 2008 Kenworth T300
- 1250 Alum PRT 2007 Ford F550 2x4
- 1500 Alum PRT 2007 Ford F550 4x4
- 800 Alum P&D Combo Unit 2007 Ford F550 2x4
- 2200 Alum Septic 2007 7500 Chevrolet
- 2200 Alum PRT 2008 Ford F750 AT AB
- 1500 Alum PRT 2008 Ford F550 2x4
- 2000 Alum PRT 2007 International 4200 AT AB

PORTABLE RESTROOM TRUCKS

- (6) 950 MD Steel - \$51,000 w/Ford F550 Chassis
- (6) 1250 MD Steel - \$59,328 w/Ford F650 Chassis
- (6) 1600 MD Steel - \$63,128 w/Ford F650 Chassis

Available For Immediate Delivery!



\$ 103,652

**Kenworth T-300
3600 Aluminum**



\$ 85,965

**Peterbilt 335
2500 Aluminum**

Order Today!

800-328-3332

www.satelliteindustries.com



Imagine The Possibilities

The Best 1,2,3 Punch in America!

Come See Us at Booth 8115

HXL400WV Plug & Play

- Liquid Cooled
- 25" Hg Continuous ● 400 CFM @ 0" Hg

The Leader In Its Class!



www.masportpump.com

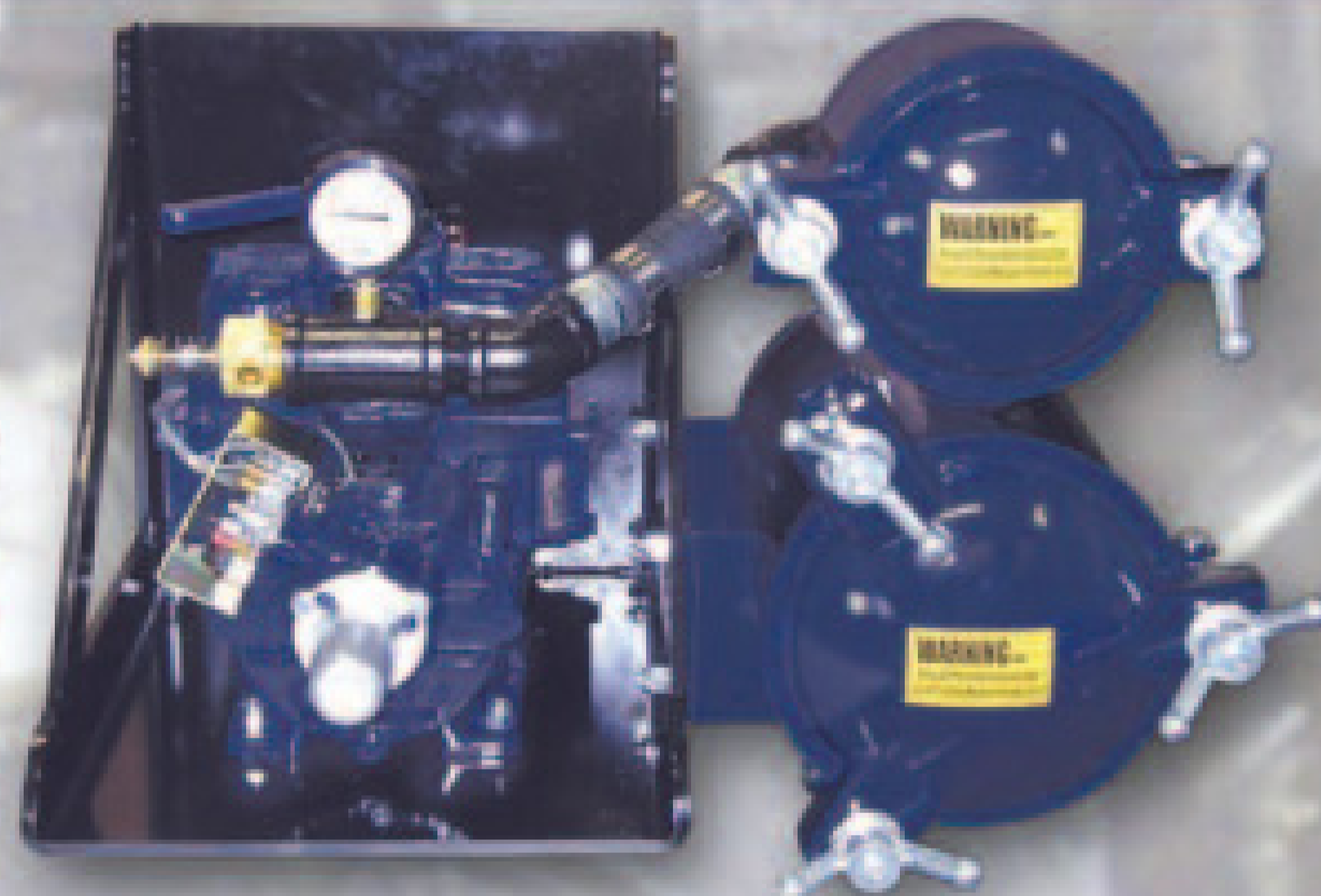

HXL4V Plug & Play

- #1 Toilet Pump in America
- 20" Hg Continuous ● 156 CFM @ 0" Hg

- Save Time!
- Save Money!
- Built For the Long Haul!

"Compared to the other pumps we still use, this one blows them away...We get quicker product movement, cutting our service time in half."

"This pump will handle anything you throw at it, no problem. I truly believe you have to experience this pump first hand to feel the brute strength."

- Cliff Doty, Tan-Aire Pumping

ROBUSCH®

RB-DV HiVac Blowers

- Runs Cooler
- No Oil, No Smoke
- 27" Hg Continuous
- Airflows 500 to 1600 CFM



To Contact a Masport Authorized Distributor
or to Receive Additional Information

Call 1-800-228-4510

Masport®

27th TRUCKS INC.

WORLDWIDE EXPORTERS

8975 N.W. 27TH AVE. | MIAMI, FL 33147

PH: 305.835.9030 | EMAIL: INFO@27TH-TRUCKS.COM

**1 Year Warranty
on Engines**

**Contact Alan @ 786-512-5597 or
Armando @ 786-267-3026**

**2 Year
Factory Warranty
on Pumps**



2001 MACK VISION CX613
4000 Gallon With Dumping
System, Jurop Pump LC420
READY FOR IMMEDIATE DELIVERY!



2003 PETERBILT C12
Cat 10 Spd., 430 Hp,
3600 Gallon Carbon Steel Tank,
Fruitland Pump RCF 500 350 C.F.M.



2000 PETERBILT C12
Cat 430 HP, 3600 Gallon
Progress Aluminum Tank
Fruitland Pump RCF 500,
350 C.F.M.



1999 PETERBILT C12
Cat, 10 Spd., 430 HP, 3600
Gallon Carbon Steel Tank,
Jurop Pump LC 420 Contender
(Extras Included)
Available for the Pumper Show.



2003 MACK
10 Spd., Jake Brake, 570K,
4000 Gallon Carbon
Steel Tank, Jurop Pump LC420.



2001 MACK
10 Spd., 330 HP,
3600 Gallon Carbon Steel Tank
(IN PRODUCTION)

**5 year Factory Warranty
on Carbon Steel Tanks**



Booth 7015, 7016, 7019, 7021, 7025

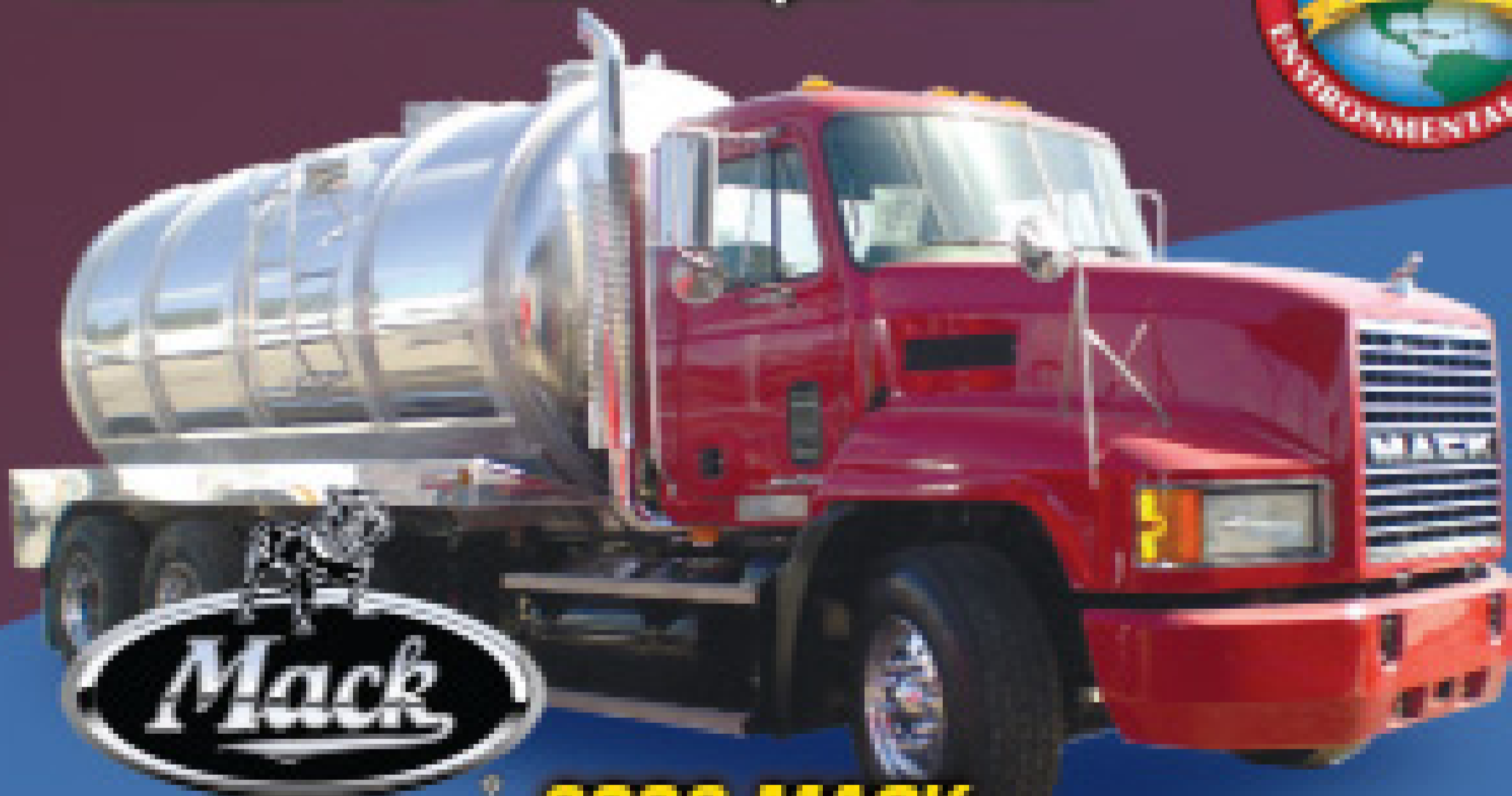

2002 MACK
4500 Gallon Aluminum Tank, 10 Spd.,
350 HP, with Tri Axle, Jurop Pump
LC420 Contender (Extras Included) with
High Quality Custom Paint Job.

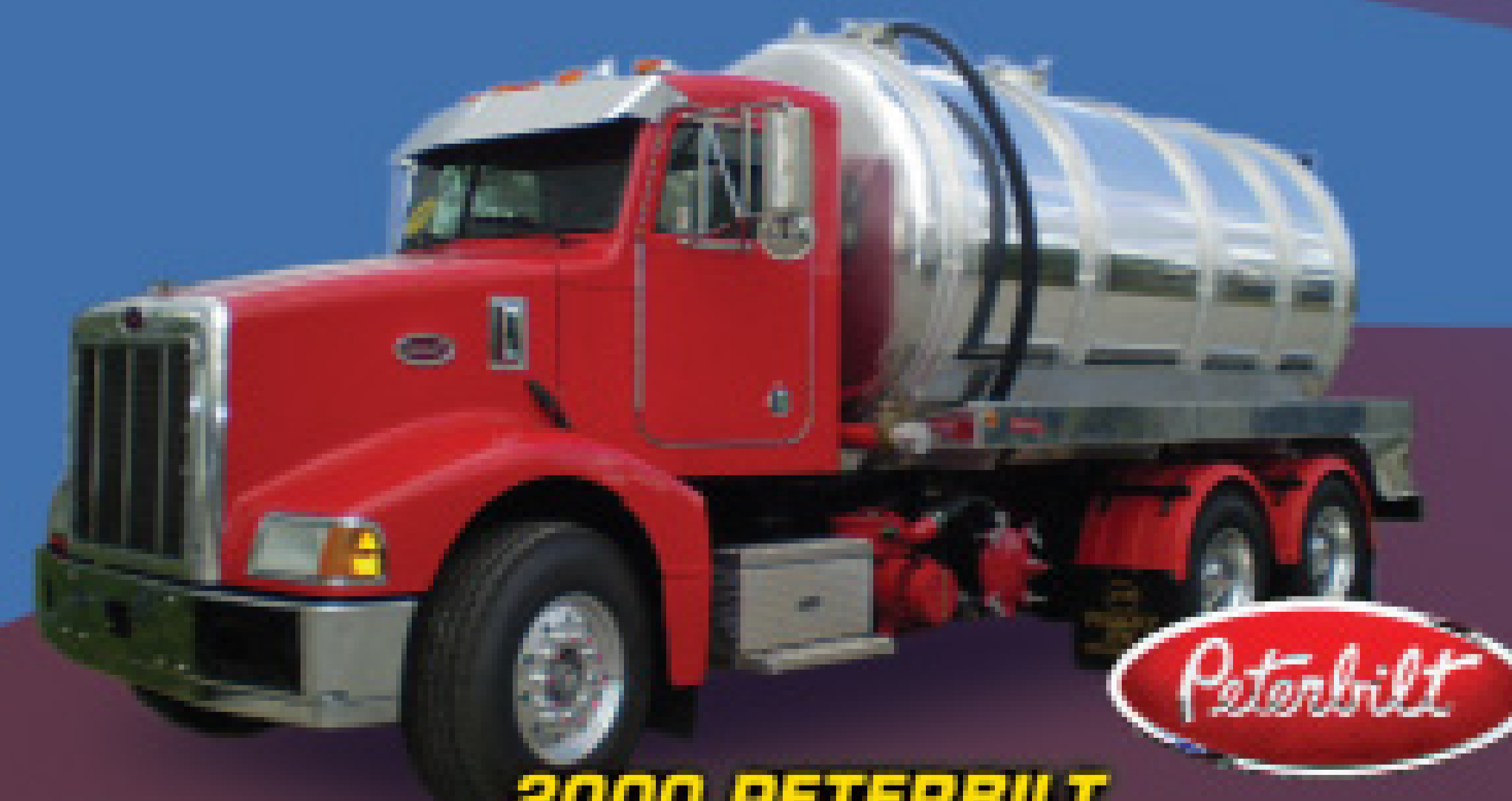

2000 PETERBILT
C12 Cat, New 4000 Gallon Aluminum Tank,
Fruitland Pump RCF 500,
350 C.F.M., Custom Build.
Ready for Immediate Delivery!
Beautiful Truck!



2001 STERLING AT9522
4000 Gallon Carbon Steel
Tank, Fruitland Pump RCF 500
350 C.F.M.

**10 Year Factory Warranty
on Aluminum Tanks**

**Special Fleet Maintenance
Trucks In Production Ready
for Delivery**

WWW.27TH-TRUCKS.NET

**FINANCING
NOW AVAILABLE FROM
CAPITAL PARTNERS**



RUBINETTERIE ITALIANE VELATTA S.p.A.

RIV Rubinetterie Italiane Velatta S.p.A.
Via delle Acacie, 8 Zona Industriale D4
28075 GRIGNASCO (NO) ITALY
Tel +39 0163 4151 Fax +39 0163 411914

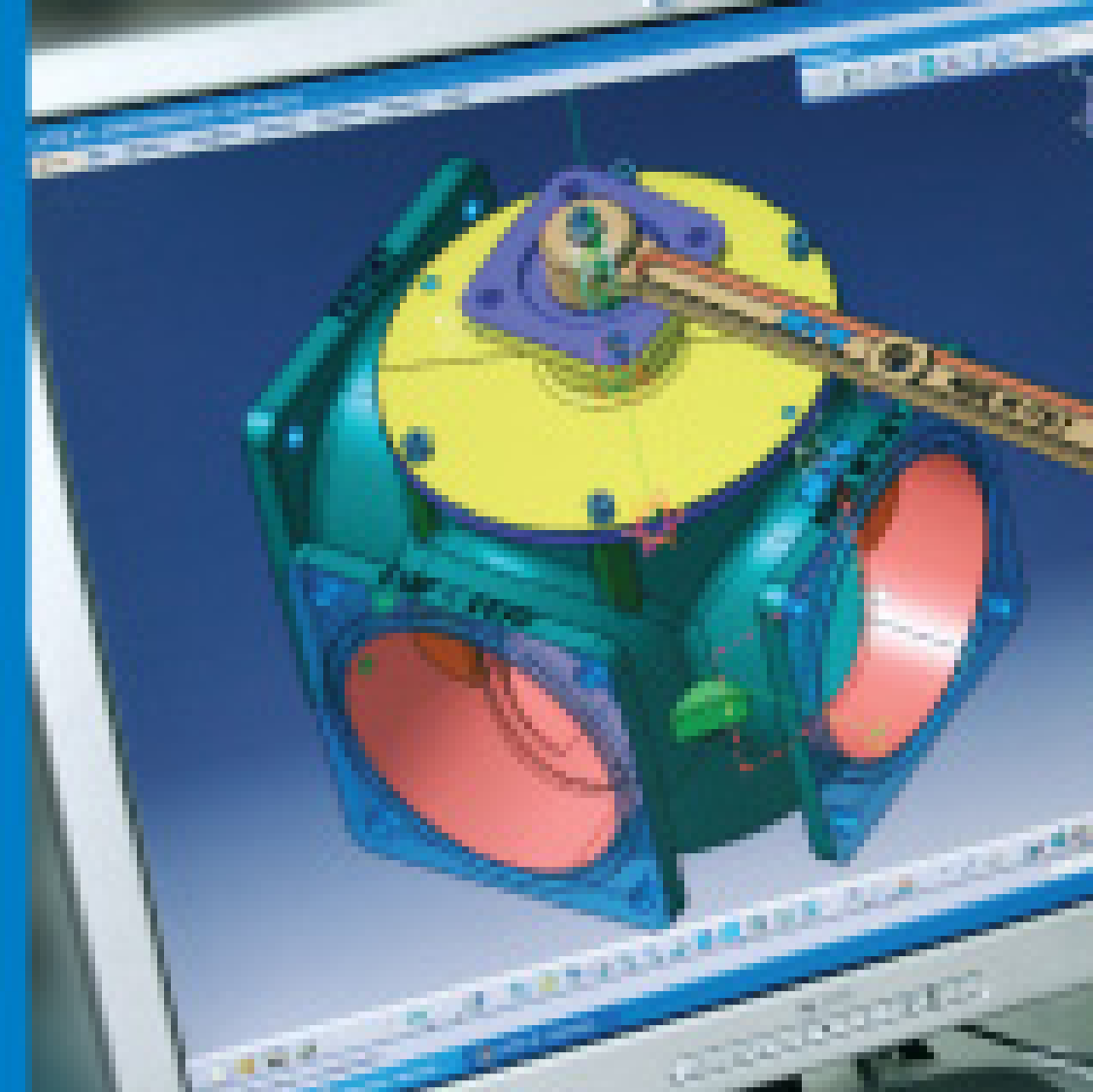

RESEARCH

DEVELOPMENT

TECHNOLOGY

Platinum

✓ PERFECT TIGHTNESS

✓ STRONG & RELIABLE

✓ LONG WORKING LIFE

✓ CARE ON DETAILS

an exceptional product

...you can't find anything better



RIV 100

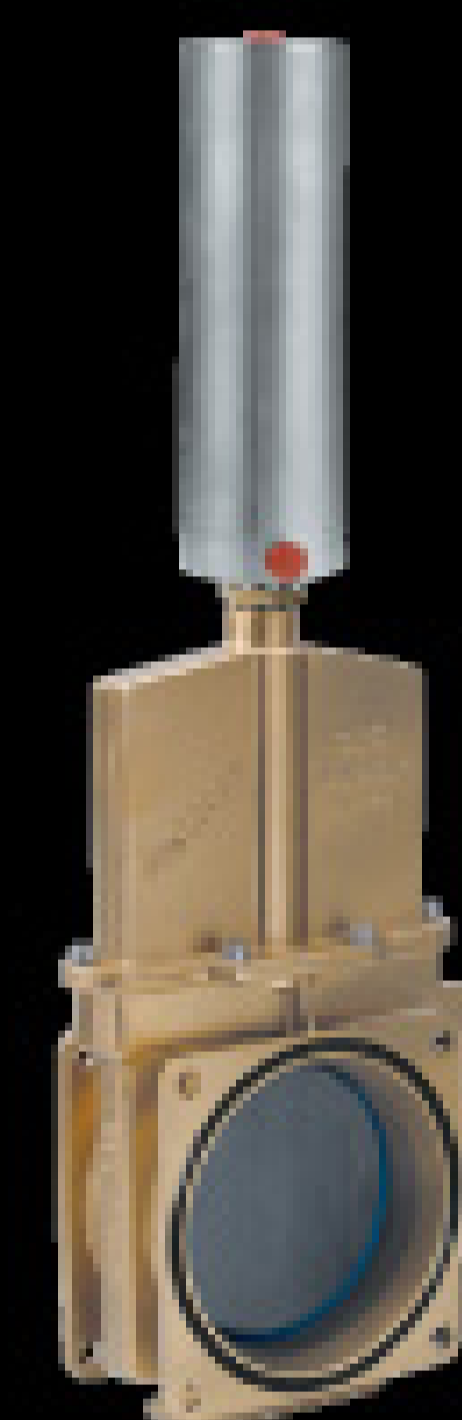

RIV 103



RIV 104

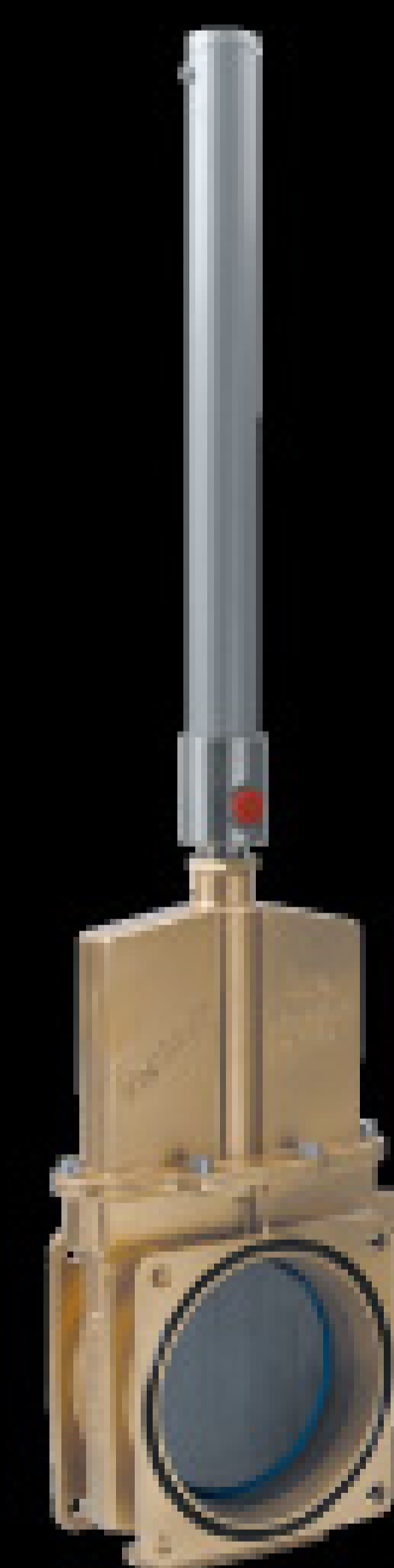

RIV 103



VELATTAGROUP

MADE IN ITALY

www.riv-vg.com

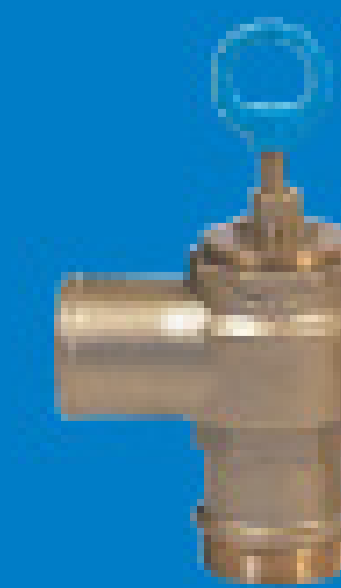

In This Issue

FEBRUARY 2008

SHOW ISSUE

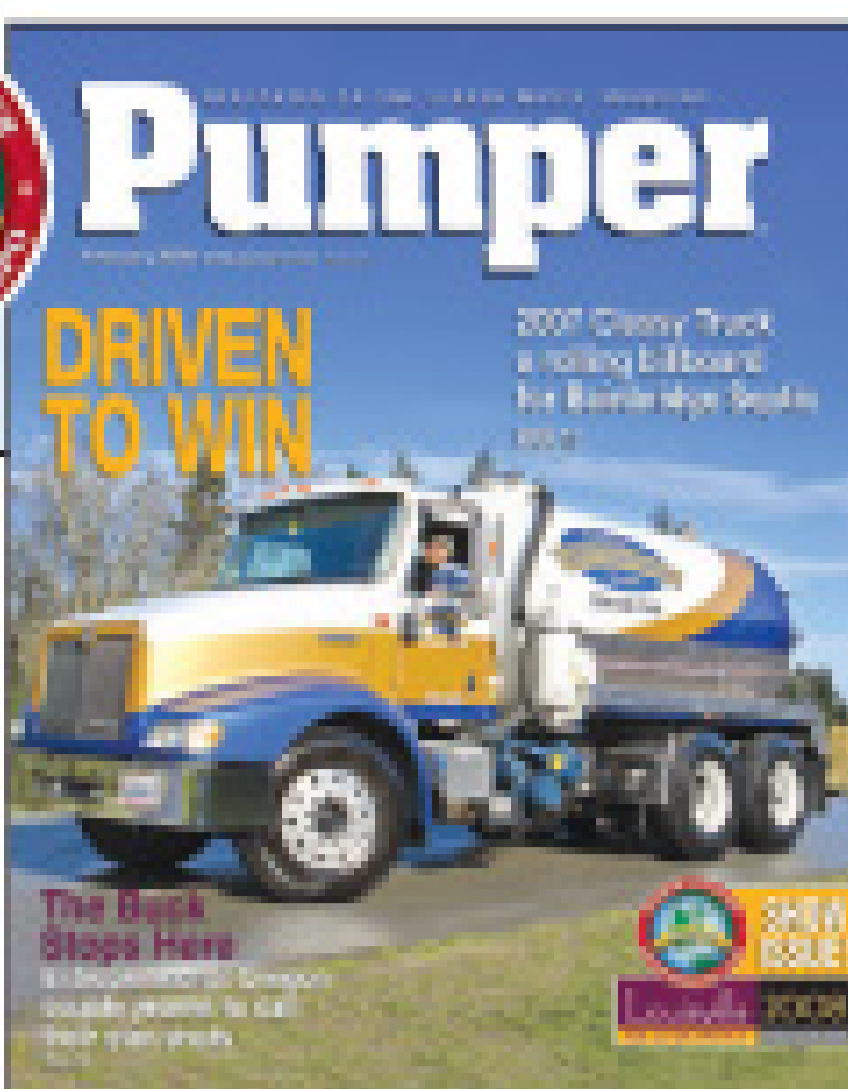

ARTICLES

10

Reading Between the Lines: 'It's a Pride Thing'

- Jim Kneiszel

On the cover: Dean Church, winner of the 2007 Classy Truck of the Year contest, says, "A clean truck on the road gives customers a good sense of who they are using and confidence they're getting the job done right." (Photo by Martin Bydalek)

16

Kenny Comes to America

Australian film focusing on an enthusiastic portable sanitation worker debuts at Pumper & Cleaner Expo.

- Jim Kneiszel

20

Building the Business: Can We Talk?

Bosses who say they want honest feedback should look for ways to get employees to open up ... and then listen to what the workers have to say.

- Daisy Saunders

30

Rules and Regs: North Carolina Bill Would Have Required Two Technicians per Truck on Some Jobs

- Scottie Dayton

38

The Buck Stops Here

The thrill of calling the shots draws an entrepreneurial Oregon couple into septic service ownership as a second career.

- Seiche Sanders

46

Pumper Interview:

Protecting Systems and Customer Base

Pennsylvania contractor Jeff Rachlin turns to a maintenance contract program to ensure proper care of systems, as well as to lock in long-term profits.

- Erik Gunn

54

Old Name, New Ideas

Fresh marketing tools and inventive disposal solutions build on a solid 60-year foundation for Michigan's Jack Spack Septic Tank Service.

- Richard Ryman

REGULAR FEATURES

100

Money Manager: Prodding Deadbeats

Consider your options when faced with a "tough customer" who seems completely unwilling to pay.

- Erik Gunn

110

Reader Pipelines:

The Route to Profitability

Workload and efficiency with "old-school" practices will dictate when you adopt automated scheduling.

- Mary Shafer

122

Septic System Answer Man:

Basic Training II: Mound Systems & Beyond

A newly minted onsite system inspector gets more advice on how to work effectively with installers.

- Roger E. Machmeier, Ph.D

130

Classy Truck of the Month

We feature Goodwin Septic Cleaning, Wisconsin Rapids, Wis.

64

Overheard Online: Weighty Issues

Posters want to know how heavy septage is, what drivers are paid and how to enhance customer education about onsite systems.

72

Lighter Side: Signature Service

A portable restroom with a backstage pass is covered with autographs of country music luminaries.

- Ken Wysocky

80

Check Your Vacuum Relief Valve

A California pumper learned a basic vacuum truck maintenance lesson the hard way.

88

Pumper Anniversaries

40th anniversary of Danbury Septic Tank Service.

140

Pumper Marketing: What Happened to Loyalty?

Strategies to encourage your best customers to come back again and again.

- Lenann McCookey Gardner

2008 PUMPER & CLEANER EXPO

91

Floor Plan, Exhibitor Listing

Find out what's in store at the Kentucky Exposition Center.

152

NAWT News: Association Sponsors Pumper & Cleaner Expo Education Day Seminar Track

- Tom Ferrero

160

Product News: Spotlight — FMI Service Trailer

- Ken Wysocky

170

Industry News

193

Association News; Training and Education; Calendar

Coming in March

Special Issue: Vacuum Trucks & Components, Fleet Management & Maintenance

- Septic System Answer Man: Determining a realistic residential sewage flow rate
- Contractor Profile: Virginia pumper has expansion plans

Pumper

DEDICATED TO THE LIQUID WASTE INDUSTRY

www.pumper.com

Published monthly by

COLE Publishing Inc.
1720 Maple Lake Dam Rd.
PO Box 220
Three Lakes WI 54562

© Copyright 2008 COLE Publishing Inc.
No part may be reproduced without permission of the publisher

In U.S. or Canada call toll-free 800-257-7222
Elsewhere call 715-546-3346
E-mail: info@pumper.com
Web site: <http://www.pumper.com>
Fax: 715-546-3786

Office hours 7:30 a.m. - 5:00 p.m.
Central Time, Monday - Friday

SUBSCRIPTION INFORMATION: A one year (12 issue) subscription to *Pumper* in the contiguous 48 U.S. states costs \$16 (24 issues for \$26; 36 issues for \$36). Subscriptions to Canada or Mexico cost \$28 per year (24 issues for \$54). Subscriptions to all other foreign countries cost \$82 per year. Subscribers are guaranteed monthly delivery of the magazine. To subscribe, send company name, mailing address, phone number and check or money order (U.S. funds payable to COLE Publishing Inc.) to the address above. MasterCard, VISA and Discover are also accepted. Supply credit card information with your subscription order.

CLASSIFIED ADVERTISING: RATE: \$1.00 per word, per month. Minimum of 20 words or \$20. All classified advertising must be PAID IN ADVANCE. **DEADLINE:** Classifieds must be received by the first of the month for insertion in the next month's edition. **PHONE-IN ADS ARE NOT ACCEPTED.** Ads may be faxed only when charging to MasterCard, VISA or Discover. Please supply all credit card information with faxed ads. Be sure to include your phone number (with area code) in your ad. Make checks payable to COLE Publishing Inc. and mail with classified ad to the address above. **CLASSIFIED ADVERTISING APPEARS NATIONWIDE AND ON THE INTERNET.** Not responsible for errors beyond first insertion.

DISPLAY ADVERTISING: Call 800-994-7990 and ask for Jeff, Jim, Kim or Winnie. Publisher reserves the right to reject advertising, which in its opinion is misleading, unfair or incompatible with the character of the publication.

CIRCULATION: Circulation averages 24,493 copies per month. This figure includes all three circulation regions (nationwide) and international distribution.

2008 PUMPER & CLEANER ENVIRONMENTAL EXPO INTERNATIONAL



Education Day:
February 27, 2008

Exhibits Open:
February 28, 29,
March 1, 2008

Kentucky Exposition Center
Louisville, Kentucky
www.pumpershow.com



moroPUMPS

"Over 50 years of service and here to stay!"

Ask for a quality Moro pump from your truck builder, or call us for the dealer nearest you.

Pittsburgh, PA . 1-800-383-6304 . fax 412-269-4172 . www.morousaeast.com . moroeast@attglobal.net
St. Louis, MO . 1-866-383-6304, 636.584.8844 . fax 636-583-2044 . www.morousaeast.com . moro@charter.net

Isn't it time to UPGRADE to a MORO?

Stop by and see us at the Louisville Show!

Complete Right Angle Packages

Completely Assembled



Booth 6101

M3
176 cfm



Pumps available from 176-1642 cfm

M10
230 cfm



PM80 350 cfm

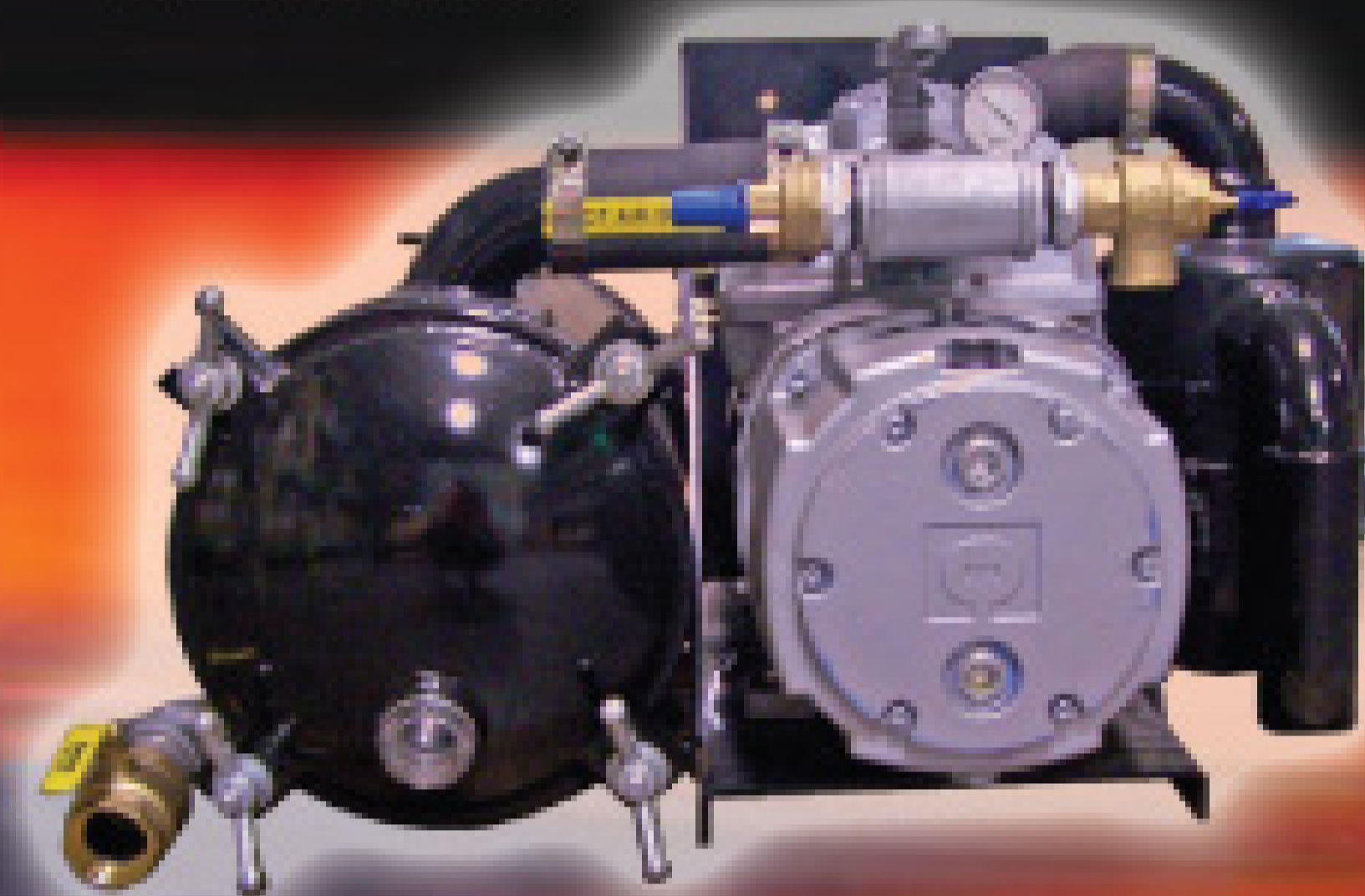

PM100
460 cfm



RIGHT ANGLE, HYDRAULIC,
GAS OR DIESEL PKGS.
AVAILABLE
ON ALL PUMPS

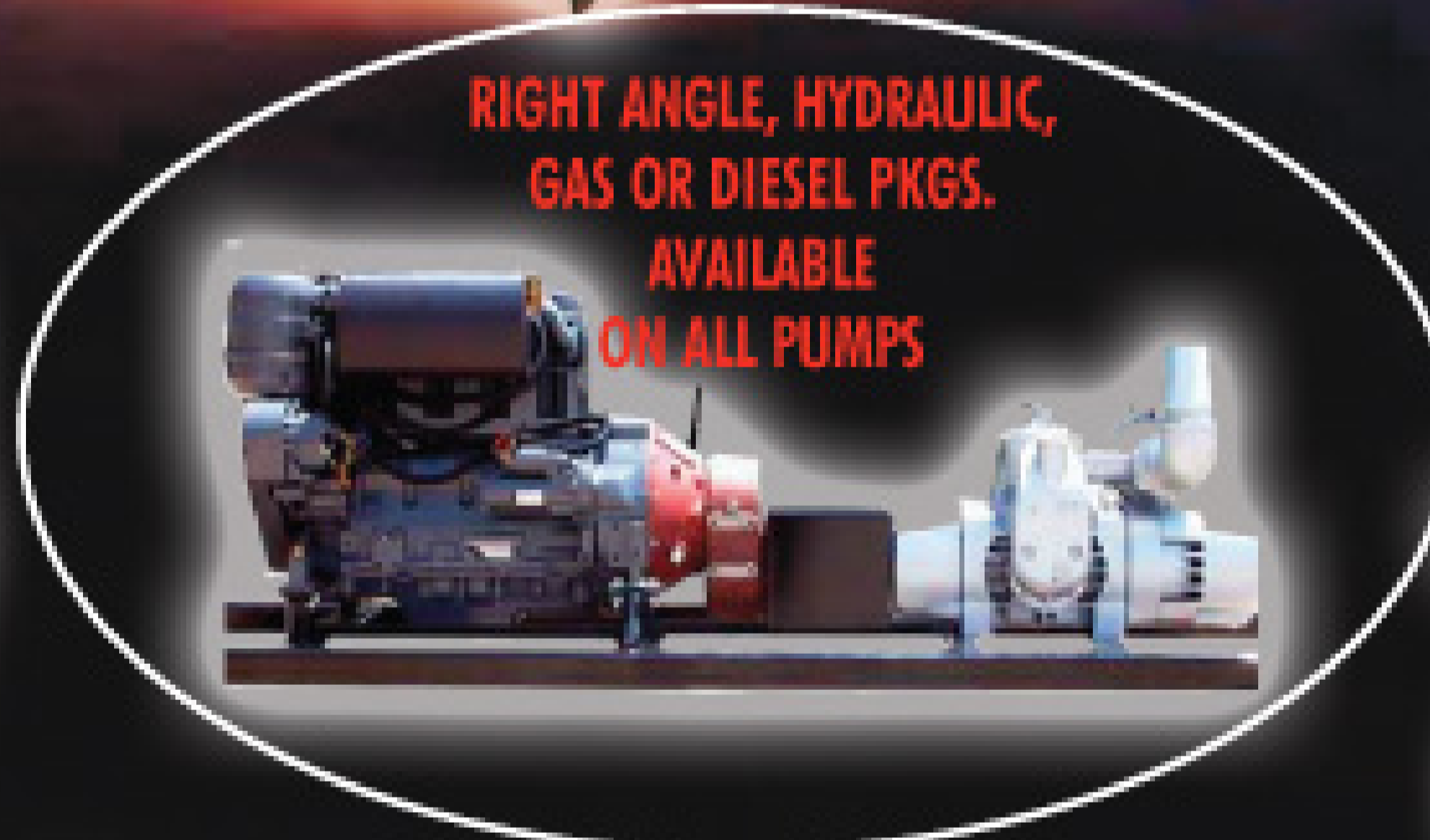

PM2600 824 cfm

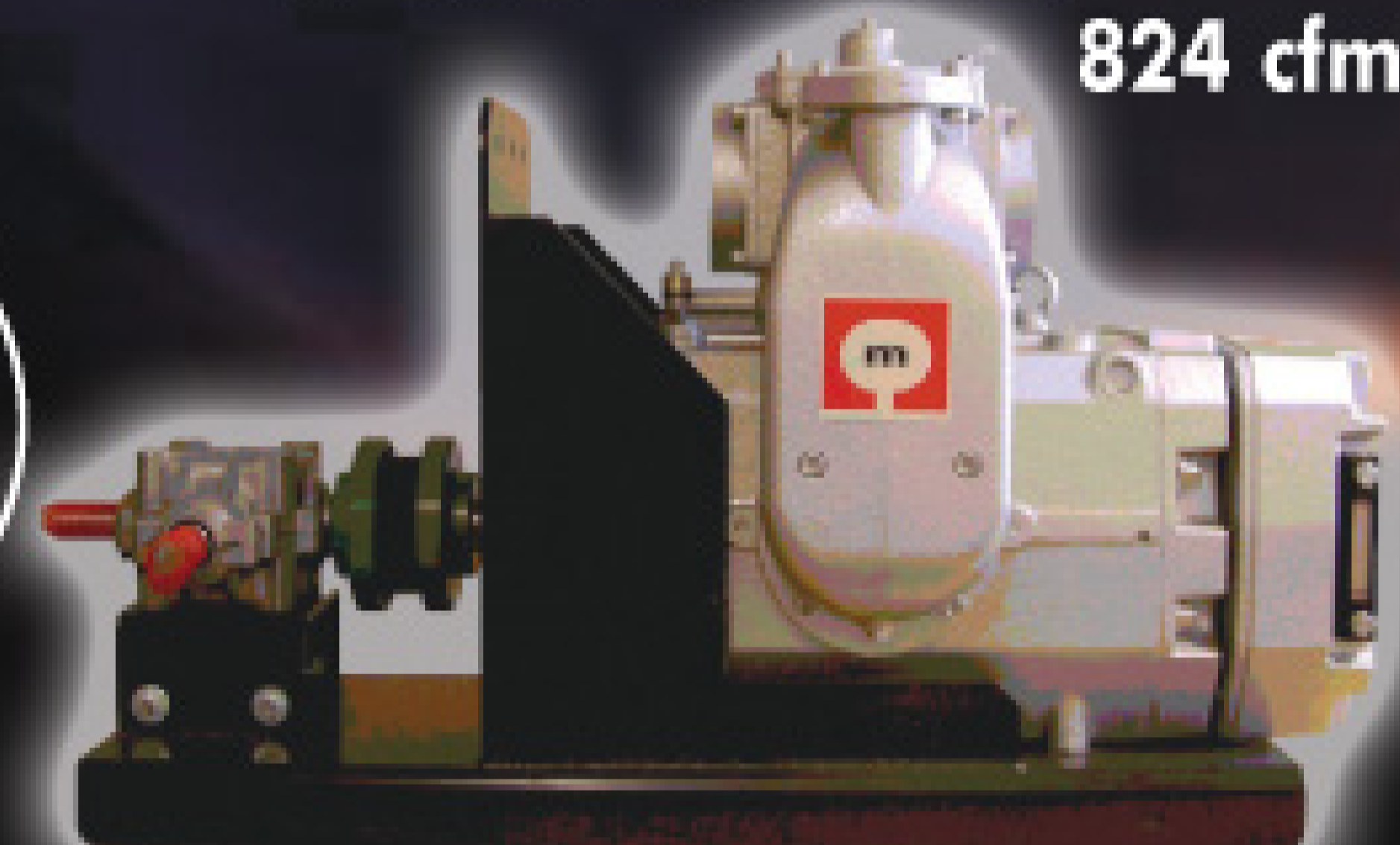

DC-STAINLESS Washdown Pump

NO COMPARISON

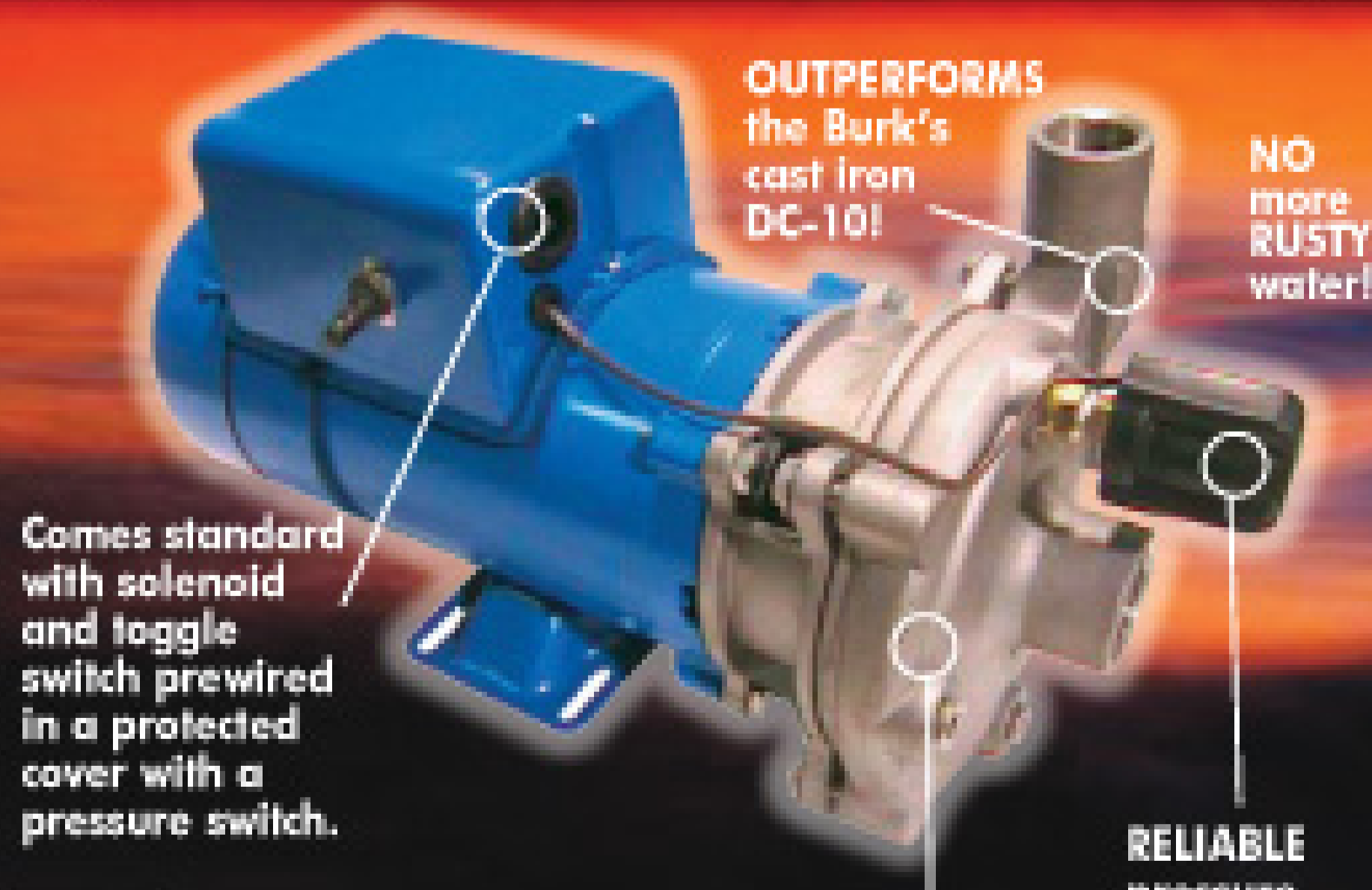

OUTPERFORMS the Burk's cast iron DC-10!

NO more RUSTY water!

Comes standard with solenoid and toggle switch prewired in a protected cover with a pressure switch.

RELIABLE pressure switch!



316 Stainless Steel Pump Head & Impeller

Quality RIV Components In Stock — Ready for Shipment



ACCU-LEVEL Accurate Tank Volume Measurement

No Balls • No Tubes • No Floats • No Worry!
No Internal Tank Components

Get paid for what you pump!

Only pay for what you dump!



Level Indicator

Factory calibrated, the general purpose indicator reads 0-100% of volume in gallons. A single push button allows users to scroll through their active channels.



Pick-up Unit

The general purpose two-wire transmitter provides non-contact level measurement up to 32' and is ideally suited for challenging corrosive, coating or waste liquids.

ADVERTISER index

February 2008

27th Trucks, Inc.4

A

A & L Systems Inc.168
A Corp/Rooter-Man130



Abbott Rubber Co., Inc.42



Abernethy Welding & Repair61
Accent Manufacturing153
Ace-Supply58
ACG Equipment Finance44
Acro Trailer Company126



Advance Pump & Equip.115
Advanced Containment Sys.148
Aero-Stream LLC77
Alar Engineering Corp.166
Allied Tank113
Almetek Industries Inc.21
Alpha Mobile Solutions104
AlturnaMats163
Ameri-Can Engineering24
American Industrial124
American Machine & Tool Co.76
Amigo Truck Ltd.30
Amthor International164
Aqua Ben Corp.168
Aqua Blast Corp.162



Aqua-Zyme Disposal Sys.148



Arcan Enterprises Inc.82



ARMAL Inc.11-13



Armstrong Equipment50, 116
Art's Truck & Equipment170
Atlanta Rubber & Hyd.78

B

B & W Mantrad Inc.164
Badger Truck Center162
Balzer Inc.76



Bandlock Corp.145
Banjo Corp.86
BDP Industries Inc.165
Beall Trailers50
Best Enterprises, Inc.159
Big Fish Environmental44
Black Tie Mfg. Inc.36-37
Blue Angel Pumps21
Brenlin Co. Inc./Seal-R162



Bright Technologies106

C

Cadman Power Equipment68



Cam Spray41

Cape Cod Biochemical25
Capital Partners LLC164



Capital Rubber Corp.48
Center Capital Corp.169



Chandler Equipment Inc.9, 17
Chempace Corporation121
Circle D Truck Sales90



Clear Computing Inc.112
Cloverleaf Tool98
Com Vac Systems158



Comforts of Home52
Community Leasing161
Concrete Sealants Inc.142
Consolidated Pipe & Tube136



Crust Busters/Schmitz Bros.108

D

Del Vel Chemical Co.153
Delta Environmental124
Denver Truck Sales168
Dragon Products28-29
Dresser Roots Blowers71
Drop Box Inc.24
Dunham & Morrow Inc.65
Dyna-Vac Equipment154

E

Earth Friendly Chemicals14-15
Ecological Laboratories59



Elastec/American Marine150
Engine & Accessory Inc.129
Eventrestrooms.com102
Excel Equip. & Supply157
Explorer Trailers - McKee108

F



F. S. Solutions98
Fergus Power Products72
Five Peaks Technology67



Flo Trend Systems Inc.119
FM Manufacturing Inc.136



FMI Truck Sales & Service73
Fruitland Tool & Mfg.104

G

Gallup Agitator Systems70
Gamajet Cleaning Systems74
GapVax Inc.127
Gardner Denver Wittig131
General Pump128
Global Vacuum Sys. Inc.167
GO FOR DIGGER142
Go Potty LLC84
Granite Leasing Co.191
Great Lakes Equip. Inc.69
Green Leaf Inc.154
Guzzler Mfg. Inc.75

H

H&M Vac Pumps & Equip.156

Hampel Corp.32-33, 57
Hannay Reels82
Hi-Vac Corp./O'Brien80
Hi-Vac Corp./Aquatech103
House of Imports101
Hull's Truck Bodies146
HUR Chemical Mfg.168

I

IHI Compact Excavators68
Imperial Industries Inc.63

J



J&J Chemical Co.99
Jack Doherty149
J.C. Gury Company Inc.128



Jag Mobile Solutions185
JGB Enterprises81

K

KeeVac Industries Inc.117
Keith Huber Inc.18-19, 84, 150
Kentucky Tank Inc.172
Key Commercial Corp.74
Kuriyama of America Inc.126

L

L.C. Tanks83
L.M.T. Inc.118
Labrie Environ. Group66
Lane's Vacuum Tank Inc.102



Lely Manufacturing Inc.89



Lenzyme/Trap-Clear Inc.58
Liberty Financial Group60
Liberty Pumps70
Liquid Waste Industries120
Liquid Waste Technology166
Longhorn Tank & Trailer Inc.184

M

Magnets by Stamp Works168



Marsh Industrial111



Masport Inc.3
Michigan Vacuum Truck Inc.144
Micro Target Media172
Mid-Continent Truck Sales173
Mid-State Tank161
Milwaukee Rubber Prod.24
Morcon Inc.42



Moro USA East Inc.7
Muncie Power Prod. Inc.65
Mytana Mfg. Co. Inc.114

N

National Truck Center105
National Vac. Equip. Inc.90
Nilodor, Inc.136
NovaFlex Hose86



NuConcepts128

O

OMSI Transmissions Inc.155
Overland Tank Inc.58

P

Pat's Pump & Blower47



Pik Rite, Inc.134
PolyJohn Enterprises195

Polylok Inc.194
PolyPortables Inc.27, 49
PolyPortables Inc./Green Way123
Power Vac Inc.112
PowerFlo Products Inc.146
Precision Tank & Equip.52



Pressure Lift Corp.120
Presvac Systems Ltd.196
Prime Solution Inc.82
Prometheus Partners107



Prototek68

Q

Quality Tank Trucks125

R

RA. Ross N. E.132



RABCO88
Ratech Electronics Limited118
Redbox +109
Reelcraft Industries Inc.60

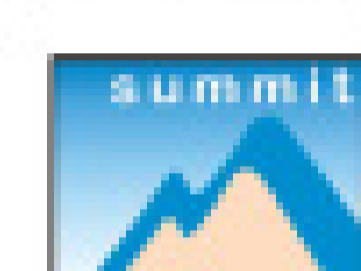

Ritam Technologies168
RIV SpA Ribinetteria5
Robinson Septic Service70
Robuschi & C.S.p.A.151
Rocket Supply Corp.106
RotoSolutions Inc.62
RouteOptix Inc.104
Rush Refuse Systems79

S

Safety Pumping Systems156
Sanitation Reminder72
Satellite Industries2, 45, 96-97
Screen Tech/Div. of Roeda66
SEMO Tank76



Septic Services Inc.134
Sludge Management112
Smithco Mfg. Inc.144
Specialty B Sales138
SPG Tanks Inc.114
Stellar Industries Inc.132
Stuart Tank108
Super Products LLC62
Supervac 2000158
Surco147
SVE Sales Inc.111
Sweet Septic Systems Inc.66

T



T&T Tools Inc.34
Tank Truck Service & Sales26



TankTec22-23



The Service Program156



Toico Industries Inc.171
Tracker Solutions142
Trans Lease184



Transport Truck Sales87



Transway Systems Inc.133
Truck Town Inc.44
TSF Company Inc.85
TST, LLC43
Tuf-Tite Inc.139

U

U.E.M.S.I.166
USA BlueBook62

V

V.E. Enterprises Inc.141
Vac-Con, Inc.51
Vacutrux Limited35



Vacuum Sales Inc.78



VAR Co.26, 102

W

Walex Products Co.53
Wallenstein Pumps-Elmira106
Water Cannon34
Wee Engineer Inc.143



Wells Cargo COG116
West-Mark Inc.137
Westmoor Ltd.31, 138
White River Distributors146
Wilcox Truck Sales74
Wolf Creek Co., Inc.52

Z

Zoeller Pump Company135

Classifieds174
Marketplace181
Truck Stop186

Western Supplement

(after page 66)

Armstrong Equipment3
Custom Tank & Equip.7
Erickson Tank & Pump5
James Wilbee Company4
TRS Industries5

Midwest Supplement

(after page 66)

Bosserman Tank & Truck2
Engle Fabrication Inc.8
Marengo Fabricated5
Mid-State Truck Service2
Milwaukee Rubber4
Pierson Co.4
Rider Vacuum Sales3
T-Line Equipment Inc.7
V&H Inc.8

Eastern Supplement

(after page 66)

Andert4
Bay State Truck4
Bosserman Tank & Truck2
Cellofoam2
Manchester Hose6
Marengo Fabricated5
Southcoast Equipment7
Truck Services of Virginia1
Vacuum Sales Inc.3
V&H Inc.6

VACUUM PUMPS BY JUROP



Truck Built by
National Truck Center
of Miami, Florida

Jurop
NORTH AMERICA



**363
CFM**

**R260
VACUUM
PUMP**



**424
CFM**

**LC420
VACUUM
PUMP**

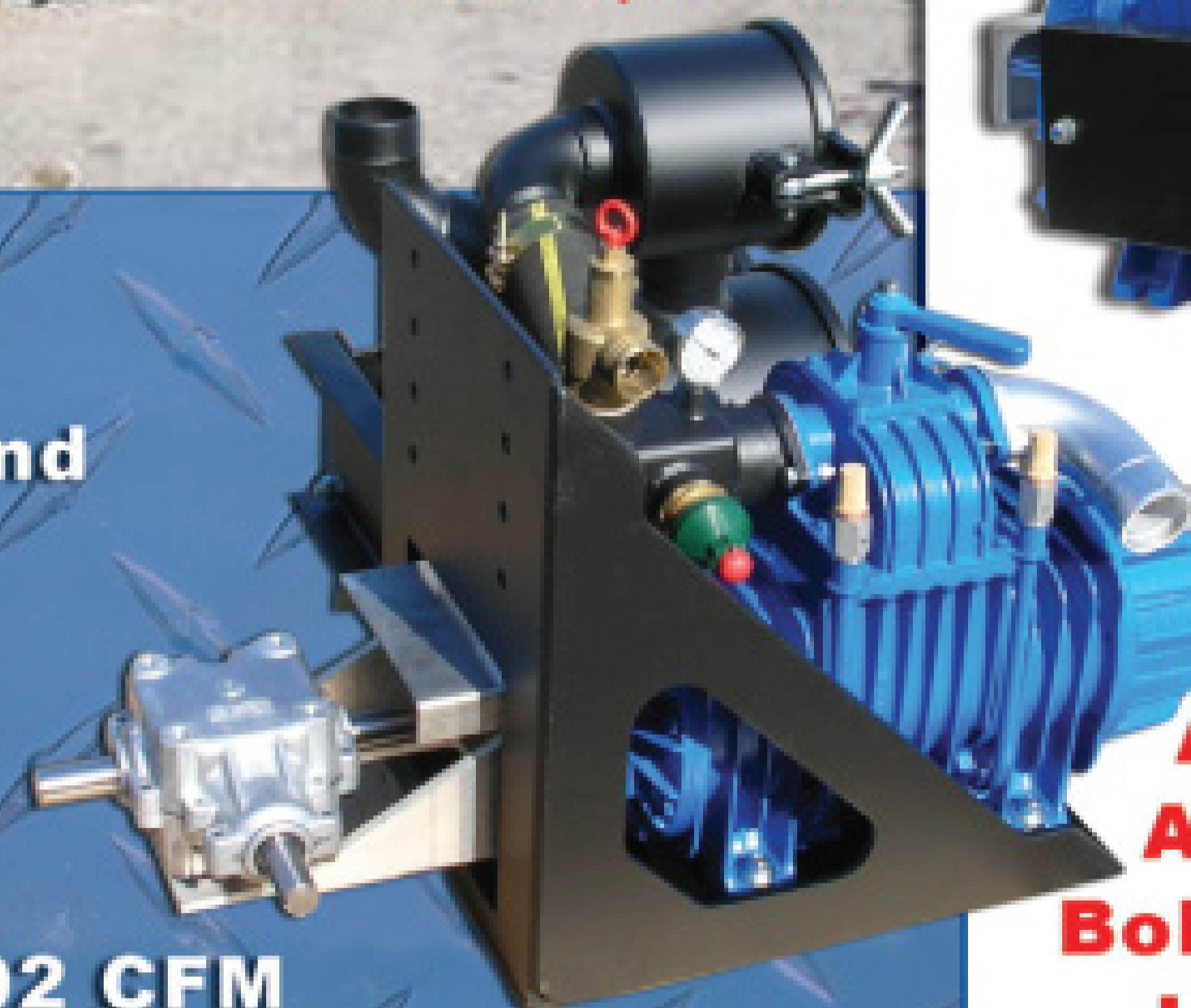

**Ask
About
Bolt-N-Go
Units**



**230
CFM**

**PN58
VACUUM
PUMP**



**795
CFM**

**PVT200
TRI-LOBE
BLOWER**

JUROP Vacuum Pumps and Blowers are designed to deliver a high level of performance.

With CFM Ranging from 92 CFM to 3710 CFM JUROP has a pump or blower for any application.

JUROP Tri-Lobe Blowers are oil free and environmentally safe. No lubrication oil is needed within the pumping chamber since the pump works without friction & consequently there is no oil delivered to the atmosphere.



Visit us in LOUISVILLE
Feb. 28-29 & March 01
2008

BOOTH 8099

**Call 800-342-0887
for a dealer near you
www.chandlerequipment.com**

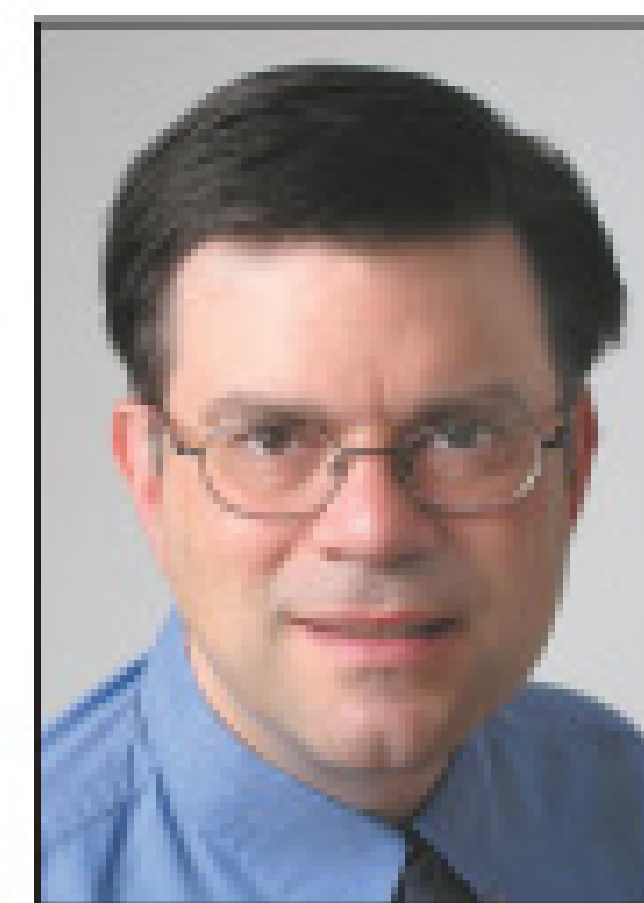

COVER STORY: Classy Truck of the Year

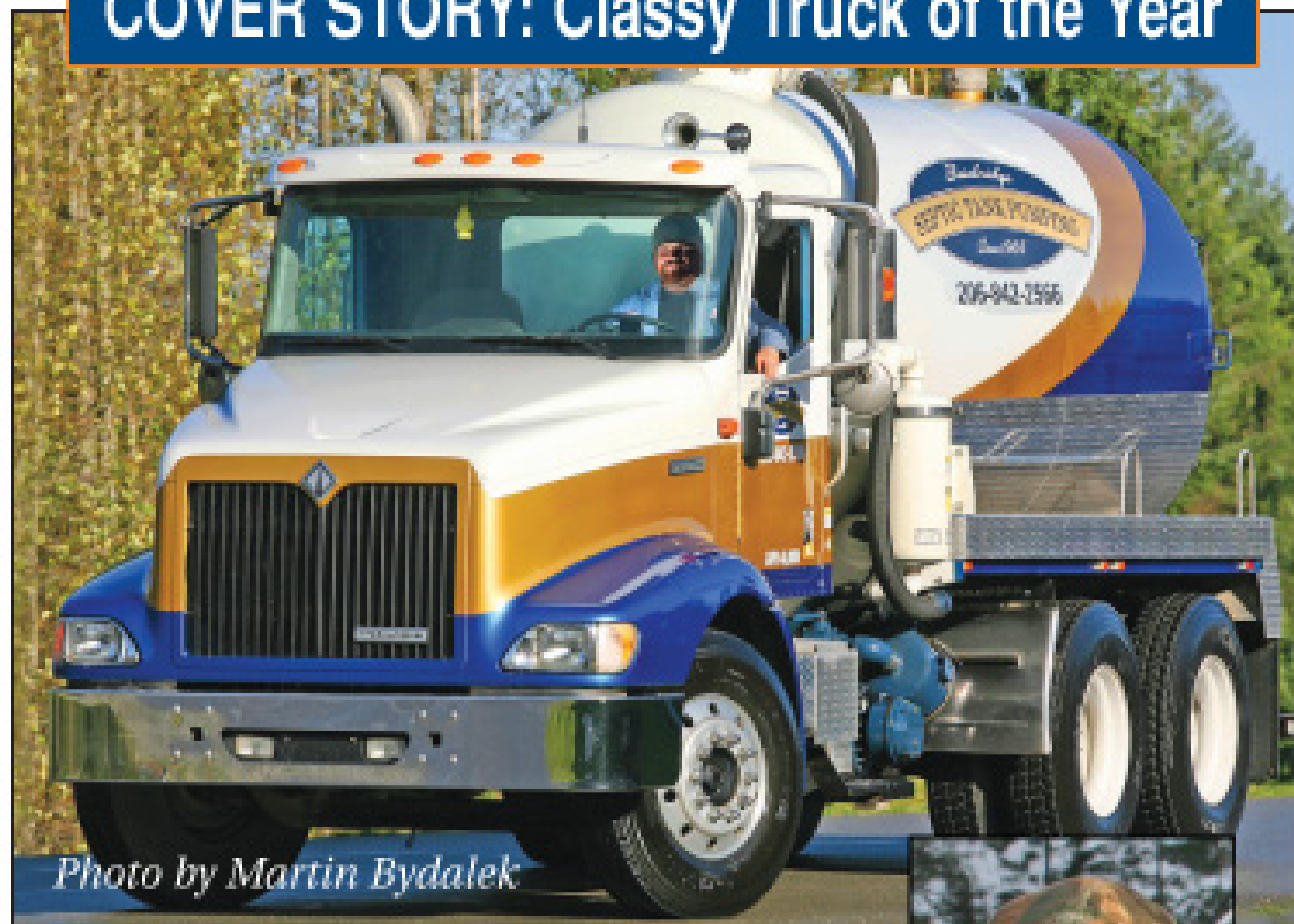

Photo by Martin Bydalek

2007 Classy Truck contest winner stresses that a good-looking rig reflects a well-run business

By Jim Kneiszel, Editor

metallic blue and gold to match the team colors of the Bainbridge High School Spartans. The same paint scheme and bold graphics by Johnny K Signs are found on all Bainbridge trucks.

Other nice touches on the truck are diamond-plate hose trays and comfort features,

children. The family is firmly rooted in the community and believe in giving, often offering their services for charitable purposes.

Church also believes he should keep the pumping business going to serve the owners of older houses on the island, as new homes typically tie into a municipal sewer and don't need septic service. The emergence of sewer service limits Bainbridge's growth, but the septic subsidiary still pumps an average of 50-60 tanks per month.

CLASSY COMPETITION

The *Classy Truck* entries keep getting better every year. I'd like to congratulate everyone who participated in 2007 and encourage all readers to send in photos of their new or refurbished vacuum trucks for 2008. The quality of trucks I see in photos that pass my desk are a reflection both of the commitment of liquid waste haulers to build a professional image and of the skill of truck builders, accessory manufacturers, painters and detailers that serve this industry. If anybody tells you they can no longer find quality craftsmanship in American industry, have them watch for the next pumping truck they pass on the highway.

ON WITH THE SHOW

As this issue of *Pumper* is being delivered to your doorstep, I'm preparing to head to Louisville, Ky., for the Pumper & Cleaner Environmental Expo International. I hope to see you at the Kentucky Exposition Center Feb. 26-March 1.

I look forward to the Expo for a number of reasons. Like so many of you who make the Expo an annual tradition, I am eager to see new products on display in the exhibit area and learn of new industry trends during the Feb. 26 Education Day seminars.

But what I look forward to the most is the opportunity to meet the pumping professionals who make this a dynamic and progressive industry. Many of the ideas for stories you see in these pages are generated while visiting with pumpers from across the country — and the world — at the Expo.

So please flag me down at the Expo and tell me about your business. If you'd like to say hello and share an idea or two for the magazine, look for anyone wearing a COLE Publishing shirt and have them track me down. I look forward to meeting you. ■

To a certain degree, you are what you drive in the pumping business, says Dean Church, owner of Bainbridge Septic Tank Pumping in Bainbridge Island, Wash.

Sure, you can provide crack service driving an older service rig with a little rust showing here and there. But the winner of the *Classy Truck of the Year* contest for 2007 says that in a world where image is everything, driving a good-looking, well-maintained rig is a strong indicator of quality service and customer care.

"Having a nice, clean truck, it's a pride thing," Church said after being told that his truck was being honored as the top entry from the monthly *Classy Truck* feature last year. "They are a driving billboard, so it's definitely important to have clean trucks. Our drivers take pride in having clean trucks, and it shows they take pride in everything they do."

Church's updated 1999 International 9100i — one of two septic trucks in the fleet that includes 24 trash, recycling and drop box rigs — was featured in the May issue of *Pumper*®. In a vote by readers and COLE Publishing staff, the Bainbridge truck beat out 11 other beautiful trucks that shared the monthly *Classy Truck* feature during 2007.

BUILDING DAVE'S TRUCK

In 2006, Church sent the truck to Erickson Tank & Pump in Qunicy, Wash., where a new 3,000-gallon steel tank and accessories were added. The truck is powered by a Cummins N-14 370E-Plus engine married to a 10-speed Eaton-Fuller transmission. Vacuum is provided by a Masport H15w pump.

When the truck was returned, it was painted by Rainbow Auto Body, with a swooping design of



"A clean truck on the road gives customers a good sense of who they are using and confidence they're getting the job done right."

Dean Church

including air-ride cab, air conditioning, heated mirrors, fog and running lights and cassette stereo. The truck maintained by driver Dave Schaber is used mostly for residential septic customers on the island in the Puget Sound and Kitsap County.

When Church sees septic pumping companies working with inferior equipment and poorly maintained older trucks, he can't help but believe the image reflects the level of service they provide. Church says he demands that his trucks reflect something more.

"We don't just pump (waste), in my mind," he said. "I don't look at it that way at all. We provide a necessary service to people who've known us all of our lives, and we help the community."

A long-time *Pumper* reader, Church said winning the contest validates his philosophy of building trucks that make a positive first impression among customers.

"Keep up on the maintenance, not just the exterior, but the mechanical part of it, too, so you don't have the breakdowns and the downtime. To me, it's not just about a picture," Church says of his truck, which takes center stage on the *Pumper* cover this month. "A clean truck on the road gives customers a good sense of who they are using and confidence they're getting the job done right."

The pumping business and its sister businesses were started by Church's late father-in-law, Don Palmer, in 1966, and bought by Church and his wife, Heather, two years ago. The couple has four

Top Line.

SEE US
AT THE SHOW
IN LOUISVILLE, KY
**BOOTH
7069**



LEONES

Armal introduces the Top Line.

The new portable toilet TOP LINE: more durable, easier to handle and simpler to clean.
With TOP LINE you get a high quality toilet at an unbeatable price and free delivery.



Armal

www.armal.biz

Armal Inc. 122 Hudson Industrial Drive, Griffin, GA 30224 - USA
Phone 770 491 6410 - Fax 770 491 9458 - Toll Free 866 873 7796
armal-inc@armal.biz

Scentbox.

SEE US
AT THE SHOW
IN LOUISVILLE, KY
**BOOTH
7069**



LEONES

International Patent Pending
PCT/IT2007/000700

Armal introduces the Scentbox.

The first portable toilet with scented wall panels printed with permanent graphics. Sturdy and easy to clean Scentbox is available in 5 fragrances, 5 graphics and 5 new colors.



**Strawberry
Field**

**Apple
Blossom**

**Pinewood
Trail**

**Rose
Sensation**

**Vanilla
Balm**

Armal

www.armal.biz

Armal Inc. 122 Hudson Industrial Drive, Griffin, GA 30224 - USA
Phone 770 491 6410 - Fax 770 491 9458 - Toll Free 866 873 7796
armal-inc@armal.biz

Mybox.

SEE US
AT THE SHOW
IN LOUISVILLE, KY
**BOOTH
7069**



LEONES

Armal introduces Mybox.

Now with MYBOX we permanently customize the wall panels of your toilet with graphics of your choice. Available in a large range of colors.



Armal

www.armal.biz

Armal Inc. 122 Hudson Industrial Drive, Griffin, GA 30224 - USA
Phone 770 491 6410 - Fax 770 491 9458 - Toll Free 866 873 7796
armal-inc@armal.biz

RESPECTUEUX DE LA PLANÈTE

ECOCOMPATIBLE

ECOLÓGICO

EARTH FRIENDLY IN EVERY LANGUAGE





EARTH FRIENDLY CHEMICALS
LEADS THE ENVIRONMENTALLY
SAFE REVOLUTION WITH
ADVANCED AND CUTTING-EDGE
PRODUCTS. OUR POWERFUL
AND EFFECTIVE FORMULAS
CLEAN THE WORLD SAFELY
AND EFFECTIVELY,
ONE COUNTRY AT A TIME.



Visit us in Louisville,
Booth 5041A

Order online at the new EFC website launching Feb. 27.
Call us for a free sample at 1.800.753.1548 • EarthFriendlyChemicals.com



KENNY Comes to America

Shane Jacobson, the main character in *Kenny*, shows off a portable restroom in a scene from the movie. (Photos courtesy of Xenon Pictures)

What: "Kenny"

When: Feb. 29, 7:30 p.m.

Where: Baxter Avenue Theaters, 1250 Bardstown Road, Louisville, Ky.

Details: The free screening for Pumper & Cleaner Expo attendees is the first U.S. showing of the Australian feature that will be released March 7 in Louisville.

For tickets: E-mail requests to kennyrsvp@gmail.com

For more info: www.kennythemovie.com

"We have high hopes for *Kenny*; it's such a feel-good movie. It's great to have the launch of the film with the Pumper & Cleaner attendees, who are very much a part of this movie."

[Stephen A. Housden, Xenon Pictures](#)

Australian film focusing on an upbeat portable sanitation worker will debut during the Pumper & Cleaner Expo

By [Jim Kneiszel](#)

An Australian hit comedy revolving around the portable sanitation industry, filmed in part at the 2005 Pumper & Cleaner Environmental Expo, will be introduced in the United States during the Expo this month in Louisville, Ky.

Kenny, the heartwarming story of a portable restroom operator Down Under, is scheduled for a free screening for Pumper & Cleaner Expo attendees Feb. 29 at a theater near the Kentucky Exposition Center, where the Expo is being held. It will be released for U.S. audiences the following week in Louisville, then move on to 10 major markets.

The film was released in Australia in 2006 and England in 2007 to positive reviews. It was nominated for several Australian film awards. The main character in *Kenny*, portable restroom operator Kenny Smythe, was the brainchild of actor Shane Jacobson, who became familiar with the portable sanitation industry while working with pumping contractor Splashdown Pty Ltd. on film sets. Jacobson and his filmmaker brother Clayton Jacobson produced the film and obtained financing from Splashdown owner Glenn Preusker.

The film is a mockumentary — a comedy in documentary style — but it doesn't make fun of the portable sanitation industry, Shane Jacobson told *Pumper*® in an interview when the movie was being released in Australia.



Kenny and a friend are wide-eyed as they visit the Pumper & Cleaner Environmental Expo. Part of the movie was filmed at the 2005 Expo.

Many of the scenes are drawn from real-life special events where Splashdown provided service.

In the movie, Kenny is proud to provide a necessary service that most people wouldn't want to do. His enthusiasm for portable sanitation is misunderstood by friends and family, and he struggles to gain the respect of both his father and his son for the job he is so passionate about.

"The great thing about guys who work in this industry, they know better than anyone how human we are," Clayton Jacobson told *Pumper*. "The only people who get put down are the audience in some ways. The film plays

into some of the preconceptions society has about the industry."

Preusker was delighted with the result.

"What I love about it, it promotes the industry in a positive light," he said. "It shows someone who has an important role in the industry that keeps everyone going."

Part of the film was shot during the Pumper & Cleaner Expo, when the main character comes to the trade show and finds validation from a large group of professionals who feel the same way he does about the industry.

"We have high hopes for *Kenny*; it's such a feel-good movie," said Stephen A. Housden of Xenon Pictures, which is promoting the film in the U.S. "It's great to have the launch of the film with the Pumper & Cleaner attendees, who are very much a part of this movie."

Zeller said the movie is an upbeat look at an everyday hero, a guy who does a tough job with a good attitude and a smile on his face. He hopes American audiences take to the main character the way Australian fans did, making *Kenny* one of the top moneymaking films of 2006 in that country.

"These people are vital to our everyday lives," Zeller says of portable sanitation professionals. "Without what Kenny does for a living, we'd all be in trouble." ■

always strong and reliable...



Booth 8099

as from today easy to install!

New

art. 3F - 4"

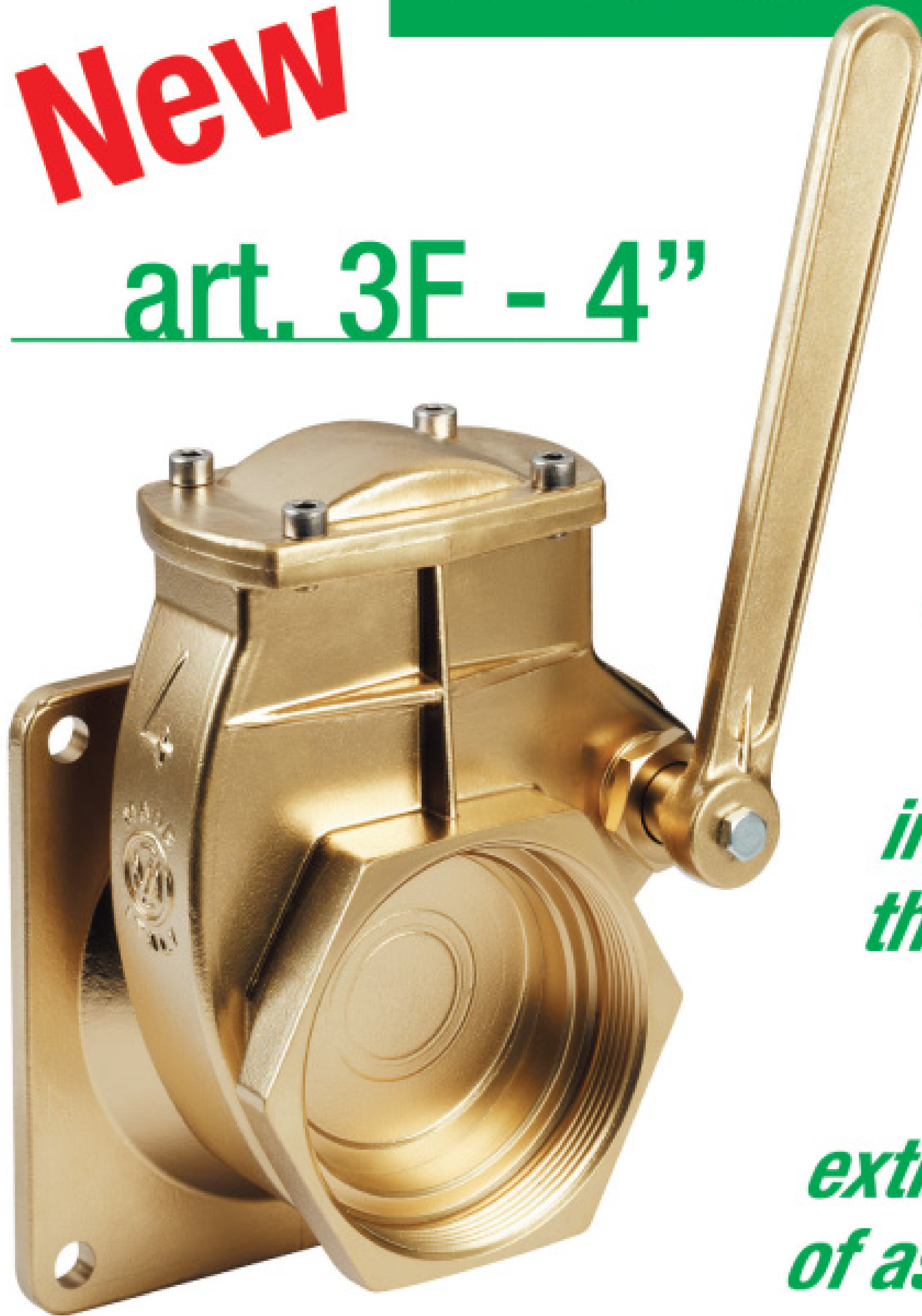

strength and reliability +

Mz standard square flange with 4 holes +

interchangeability with the stem gate valves +

extreme simplicity of assembly +

NEW LEVER GATE VALVE WITH 1 FLANGE!



METALTECNICA s.r.l.

www.metaltecnicazanolo.com



Chandler
Equipment, Inc.

Toll Free 1-800-342-0887
www.chandlerequipment.com

USA DISTRIBUTORS

Improving your business performance

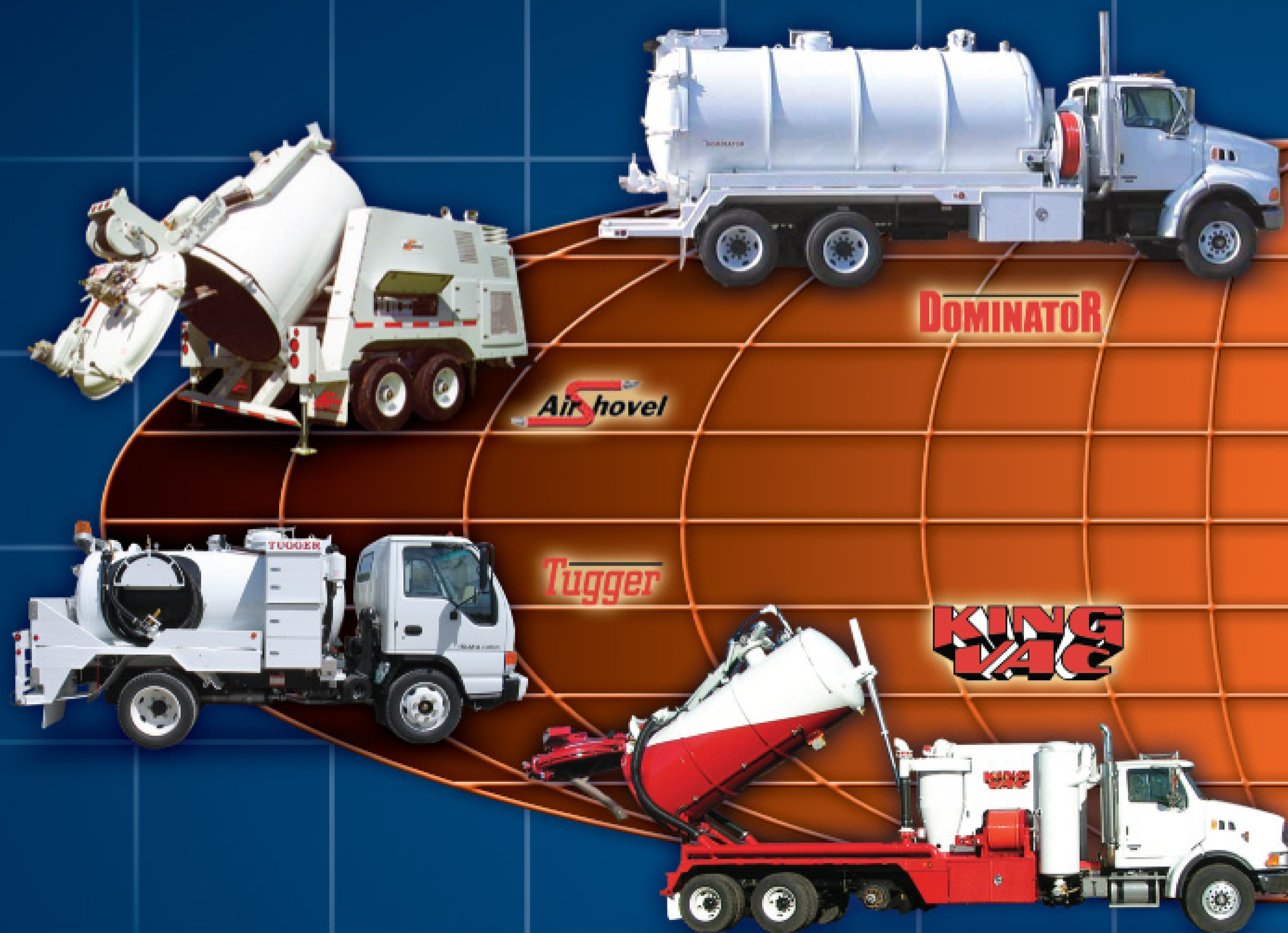

Our entire product line is designed,

World wide manufacturers of vacuum loading and hydroexcavation equipment, transport trailers, industrial jettors and portable restroom service vehicles.



Visit our island

Booth 14039

Louisville, KY

with advanced vacuum technology



Princess



BERRINGER



Transport Trailer

engineered and manufactured in the U.S.A.

See our latest technology
on display at Island #14039,
visit our website at www.keithhuber.com
or give us a call at 1-800-334-8237



Can We Talk?

Bosses who say they want honest feedback should look for ways to get employees to open up ... and then listen to what the workers have to say

By Daisy Saunders

Manny is the owner and general manager of a small car dealership with 10 employees, similar to many small businesses that install, maintain and pump septic systems.

On numerous occasions, Manny boasted that his company operates like a close-knit family. He is proud of the way everyone pulls together to serve the customer. However, for the past two years, sales have declined and Manny became determined to change the trend. At weekly team meetings, he made a concerted effort to get ideas on expanding the company's customer base. To his surprise, no one offered suggestions.

At a loss as to why he gets no input from his team, Manny hired a consultant to coordinate a creativity/brainstorming session. At the beginning of the meeting, Manny informed the consultant that he had to leave for 30 minutes.

When Manny left the room, the consultant asked how the staff felt about the session. He got an earful. The overall consensus was that although Manny boasted about an "open-door policy" and an interest in their ideas, most of their suggestions had been ignored. So they simply stopped sharing them. Some people even felt that Manny had an "I'm the boss" or "Do it my

way" attitude. Therefore, they were reluctant to approach him with concerns or suggestions.

While Manny had a team that pulled together when necessary, he had inadvertently and unknowingly failed to create a work environment that fostered a climate promoting open communication. In such a climate, employees feel free to express opinions, voice complaints and offer suggestions. This freedom of expression is fundamental to creativity and innovation.

Research has consistently shown that an open communication climate has seven distinct characteristics:

1 Employees are valued
Employees are a reservoir of information. They want to be heard and feel they are making significant contributions. Your response to their concerns shapes how they feel about their value to the company. Nothing is more demoralizing than asking employees for suggestions, then ignoring them without clearly explaining why. When you ignore their ideas, you send a message that their opinions don't count.

When employees don't think their opinion counts, they feel detached and insignificant. Ultimately this impacts employees' attitudes, which in turn, impacts customer service. On the

other hand, when you recognize an employee's suggestion — whether you implement the suggestion or not — it builds confidence in the company and reinforces to employees that their efforts can make the organization better. In essence, employees are happier and more motivated when they feel they are appreciated and treated with respect.

2 There is a high level of trust
Trust forms the foundation for open communication, employee retention and employee motivation. Individuals who trust the people they work with are self-assured, open and honest, willing to take risks, less resistant to change, and inclined to act in a trustworthy manner. In contrast, individuals who distrust the people they work with tend to be less productive because they feel unsupported and alone. Trust in an organization promotes cooperation, commitment and a free flow of ideas. It can help an organization survive and achieve a competitive advantage. A key factor in maintaining a high level of trust is to always tell the truth.

3 Conflict is invited and resolved positively
Conflict itself isn't good or bad — it's just inevitable. Make it work for you by using it to invite give-and-take dialogue with employees. When dealing with conflict, be open-minded and listen. Take into account the employees' feelings about the situation and find areas within their position in which you can both agree. If you don't have conflict,

you don't have innovation and creativity.

4 Creative dissent is welcomed
Surveys have consistently showed most employees are afraid to question or disagree with their superiors. However, in an organization where the leaders are committed to fostering an open communication climate, dissent is not only welcomed, but also rewarded. Employees are encouraged to think, question, form independent judgments and take responsibility for changing the way business is done.

One way to encourage employees to think is initiating an employee suggestion program. This allows the employees to come up with ideas on how to improve the company and they are, in turn, rewarded for that. Being able to express unique ideas allows employees to feel as if they contributed to the company in a positive way.

5 Employee input is solicited
In any serious quality effort, a key is that all employees be involved. Employee input is a key to an organization's success. Do not limit open communication to staff meetings. Create a questionnaire or grievance form in which employees can express concerns in a confidential way and then discuss it openly during a meeting. This method helps provide information regarding your company that you may not be aware of and establishes a sense of involvement for the employees.

Daisy Saunders is a leadership consultant and author of Big Eyes ... Big Eyedeas for Achieving Optimum Success in Business and in Life. She can be reached through her Web site, visit www.BigEyesIntl.com.



When dealing with conflict, be open-minded and listen. Take into account the employees' feelings about the situation and find areas within their position in which you can both agree. If you don't have conflict, you don't have innovation and creativity.

TankTec

Tank Technologies & Supply Co. LLC

Portable
Restroom
Service Trucks
Septic, Grease & Grit Trucks

2007 International 4200
2000 Gallon

From **\$76,900**

Lease from \$1070/Month



2008 International 4400
2500 Gallon

From **\$89,500**

260 Horsepower • 6-Speed
33,000 GVW • 3 or 4 inch Inlets
4 or 6 inch Dump • Toolbox
Masport HXL15V 350 CFM Pump

Lease from \$1305/Month



2008 International 4400
3600 Gallon

From **\$103,900**

300 Horsepower • 10-Speed
54,000 GVW • 3 or 4 inch Inlets
4 or 6 inch Dump • Toolbox
Masport 400WV 400 CFM
Water-Cooled Pump System
Lease from \$1515/Month

2008 International 7500
4200 Gallon

From **\$118,900**

350 Horsepower • Alison Auto
56,000 GVW • 3 or 4 inch Inlets
4 or 6 inch Dump • Toolbox
Robuschi RB-DB45 500 CFM Blower Pump
Lease from \$1730/Month

See this
Truck at the
Pumper Show!





Booth 4133

888-428-6422

**ANNOUNCING:
SPECIAL FINANCING
ON INTERNATIONAL
CHASSIS!**



Low interest and great terms
means low lease
and loan payments!

Call us for a quote.
We have great relationships
with multiple finance
sources on ANY chassis!

Call and ask about
**PRE-PUMPER SHOW
SPECIALS!**

Standard PRS Features:
Masport HXL4V 160 CFM
Vacuum Pump System
Burks DC-10 Water Pump
Fold Down 2 Toilet Hauler
2 Large Work Cabinets

**2008 Ford F550
1250 or 1500 Gallon**

From **\$67,200**

Auto Trans • Hydraulic Brakes
2WD • 4WD Also Available
Lease from \$1319/Month



**2008 Kenworth T300
1700 Gallon**

From **\$74,500**

22,000 lb G.V.W. - Non-CDL
Cummins Diesel • Hydraulic
Brakes • Allison Automatic
A/C • AM/FM • Aluminum Cab
Lease from \$1036/Month



**2007 Chevy 7500
2000 Gallon**

From **\$74,500**

Automatic
Hydraulic Brakes
Air Brakes Available
Lease from \$1460/Month



Ask About In Stock Trucks • Call for Lease Payment Details
Tanks in Stock • Financing and Leasing Options Available • Dual-Use Options
Customize to Your Needs • PRS 800-2500 Gallon • Vacuum 1000-6000 Gallon



Tank Technologies & Supply Co. LLC • 888.428.6422 • www.tanktec.biz

Steve Nelson • snelson@tanktec.biz
Andy Nelson • anelson@tanktec.biz

Local • 763.755.8075 • Fax • 763.757.9788
10100 Quinn St. NW, Minneapolis, MN 55433



Restroom Dropped On Site

NEW PORTABLE, COMMERCIAL QUALITY RESTROOMS



Interior/Restroom Stalls | Interior/Utility Sink | Storage Tanks

- Heat & AC
- Lighting
- Rubber or Rhino Lined Flooring
- Electrical Outlets
- Hot Water Heater
- Utility Sinks
- Urinals & Stalls
- Self Contained 1500 gal Fresh Water Tank/1500 gal Sewage Tank
- Or Hook Up Directly to Existing Utilities
- Level Indicator Alarm

- PROFIT GENERATION**
- \$ Monthly Rental
 - \$ Bulk Pumping
 - \$ Potable Water Hauling

- POTENTIAL CUSTOMERS**
- Special Events
 - Industrial/Construction Sites
 - Community Functions

DROP BOX 1.888.388.7768
www.dropboxinc.com

Kanaflex® 220RS Rubber All-Weather Suction Hose
SUPER FLEXIBLE IN COLD WEATHER

Call for Low Prices on 100' Lengths & Coupled Hose Assemblies

A revolutionary new method of manufacturing rubber suction and discharge hose has drastically reduced costs to hose users. The new process, ten years in development, utilizes Kanaflex SBR TYPE "T" POLYMER to give the lightweight, rubber hose outstanding flexibility and long life.

New Series 220 rubber suction and discharge hose has excellent dimensional stability and is easy to couple. Manufactured in six sizes from 1-1/2" through 6", the hose is available in 100' lengths. I.D. and O.D. are smooth. Temperature range is -40° F to 160° F – ideal for industry and construction job site use.



SAVINGS UP TO **50%**
FOR SUCTION & DISCHARGE HOSE USERS!

Distributors of: **Dunlop • Goodyear • Kanaflex • Plastiflex Hi-Vac & Other Hose • P-T & Evertite Quickcouplers Dixon & Le-Hi Couplings • Hose Clamps • Banding Equip.**



Booth 3209

MRP

Milwaukee Rubber Products, Inc.

Toll-Free 1.800.325.3730
www.milwaukeeerubber.com

FAX: 262.781.1742

MAILING ADDRESS: P.O. Box 451 . Butler, WI 53007

WAREHOUSE: N52 W13319 Falls Creek Ct. . Menomonee Falls, WI 53051

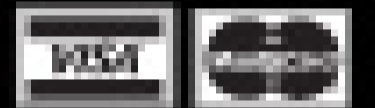

Choice. We offer **MORE** than all the others combined.

More choices of exteriors - *these are just a few!*



More choices of interiors - *many more online.*



- Restroom Trailers | Shower Trailers | Combination Shower / Restroom Trailers | ADA Trailers | Decontamination Trailers | Hand Wash Trailers | Drug Screen and Lab Trailers

More Choices...

- 75 floorplans to choose from
- Wide range of exterior designs
- Choice of 9 unique interiors or design your own
- More Features
- More Options
- More Functionality
- More value for your investment



Booth 5053

AMERI-CAN ENGINEERING

15886 Michigan Rd | Argos, IN 46501

574-892-5151

Visit our Online Catalog - **www.ameri-can.com**

WELCOME TO THE LOUISVILLE SHOW

Congratulations to Bob Kendall and COLE Publishing on the 28th annual convention for the septic professions. This is the first year for the Expo in Louisville, so there will be many new and exciting things to see and do.

Hopefully you've gotten in town early enough to take advantage of **Education Day** on Wednesday, a full day of seminars and workshops on a broad spectrum of topics pertinent to the septic trades. And don't miss the **Jeff Foxworthy** Show on Thursday and the Saturday night jam, featuring country sensation **John Corbett**, and multiplatinum country recording artists **Big & Rich**.

And while at Expo, please be sure to stop by **Cape Cod Biochemical Company's Booth #149** on the center aisle just inside the main entrance.

Cape Cod has been serving septic contractors since 1976 and are considered to be industry leaders, pioneering many programs for on-site waste treatment, both residential and commercial. We have advertised in every issue of Pumper, and we have exhibited at every Expo. We attribute our unparalleled growth to two main things (besides our excellent products, competitive pricing, and unbeatable service):

1. We are known for miniaturizing successful treatment plant technologies for on-site use; and
2. We are famous for our commitment to Customer Education.

Bacteria Buyer's Guide

Biological waste treatment products—sometimes referred to as “additives”—have been used in municipal waste treatment facilities since the mid-1950's. Now the benefits of bacteria products are being recognized to enhance the operation of residential septic systems as well.

When purchasing septic or grease waste additives, there are several important things to consider:

1. **PRODUCT:** Be sure you are getting the best product available for your application.
2. **SERVICE:** Be sure the company you are dealing with is actually in the bacteria business. If they are, they can fill your orders quickly, and they will have the best prices. Avoid companies in other businesses tagging along for the ride selling someone else's product.
3. **SUPPORT:** The company you choose to deal with should stand behind their product(s) with technical and marketing support. Again, be sure the company you are dealing with is in the business full-time. This is not a part-time industry.

Products Available

The following state-of-the-art, USDA-Approved bacteria/enzyme products are manufactured by Cape Cod Biochemical Company specifically for the septic industry:

1. **ccls:** a very high-potency, liquid formulation of bacteria and enzymes. This is the best residential septic system maintenance product available. This is the product to offer when you're asked, "Is there anything I can put in my tank...?"
2. **BIO-REM E-D:** a broad-spectrum, granular bacteria/enzyme product formulated for treatment of grease not requiring an automatic system. This is our best product for commercial and institutional use and is also effective for restoring drainage to clogged leaching facilities.
3. **DrainMaster:** a liquid concentrated drain cleaner. It is a very high-count product for residential and commercial use. DrainMaster is available with an automatic injection system for restaurant grease waste systems.
4. **BIO-GEL:** gelpacs for treatment of grease waste in small interior grease traps and floor sinks.
5. **OC ODOR CONTROLLER:** bacteria-based, non-formaldehyde product for portable restrooms.

Service and Support

Cape Cod Biochemical Company manufactures its own products all the time, and always has fresh inventory in the warehouse, ready to ship within three working days of order (or faster!).

Cape Cod Biochemical Company has been providing top-quality septic system and grease waste products to septic-related contractors since 1976. We offer complete technical support for problem systems, commercial applications, bid information, and competitive product analysis. We are in business to solve problems—not just to sell products.

Cape Cod's marketing program is the best in the business due to a 30-year commitment to Customer Education. Our Customer Education brochure, "What Everyone Should Know About Septic Tank Systems", is the industry standard. It explains septic systems in layman's terms and with plenty of diagrams. It is the most widely distributed brochure in the trades, and it is available exclusively through our network of dealers. This brochure and all our Customer Education materials are available for viewing in our booth.

Visit the Customer Education Center

Come see us in Booth #149. Have a seat in our living room atmosphere. Look at our product information, network with our dealers from all over the US and Canada, and take advantage of our "Show Specials". Let us show you how to educate your customers about how their septic systems work, why they fail, how to keep them from failing, and why they need maintenance. Find out why more contractors use products from Cape Cod Biochemical Company than all the others combined.



Directions to Booth #149

When you come in the Main Entrance to the Expo, come down the first aisle and look for the "Cape Cod Biochemical Company" banner on your left. Don't get distracted by imitators. Just relax in our comfortable booth, meet our friendly personnel, and see why company President Rick Howe was named by COLE Publishing as one of "25 Pioneers" at the 25th Expo.



Rick Howe, President of Cape Cod Biochemical Company

For more information on Cape Cod Biochemical Company's products and program, please call toll-free 1-800-759-2257 or visit us online at www.septiconline.com. We will send you our product information packet—including prices—and a limited supply of Customer Education brochures, at no cost or obligation. If you have never seen "What Everyone Should Know About Septic Tank Systems," you owe it to your customers and your business to check it out. Thank you. **-Rick Howe, President**



Partners with Septic Professionals Since 1976



CAPE COD BIOCHEMICAL COMPANY

P.O. Box 990 • Pocasset, MA 02559

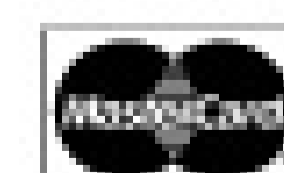

1-800-759-CCLS

(1-800-759-2257)

FAX: 508-564-9974

www.SepticOnline.com

**JUROP LC420
PUMP**

- 425 CFM-CONT. DUTY AT DEEP VACUUM
- AUTOMATIC OILING
- WATER COOLED FROM TRUCK ENGINE



FOR 2000-8000
GALLON TANK
HEAVY DUTY
APPLICATIONS

\$3725⁹⁵

**JUROP R260
PUMP**

\$2975⁹⁵



FOR 2000-6000
GALLON TANK
HEAVY DUTY
APPLICATIONS



Booth 6191

- 363 CFM
- 21 PSI
- 18" CONTINUOUS DUTY
- BALLAST PORT COOLING
- AUTOMATIC OILING

BLOWOUT SPECIALS FOR FEBRUARY

**CALL US ABOUT
THE AVAILABLE
JUROP-PAKS**

**PN84 PUMP
\$1810⁹⁵**



FOR 1,000-2,500
GALLON TANK
STANDARD DUTY
APPLICATIONS

- 317 CFM & 21PSI
- FORCED OIL LUBRICATION
- BUILT-IN RESERVOIR
- HEAT RESISTANT KEVLAR VANES



**PN33
GREAT FOR
PORTABLE TOILETS**

\$1205⁹⁵

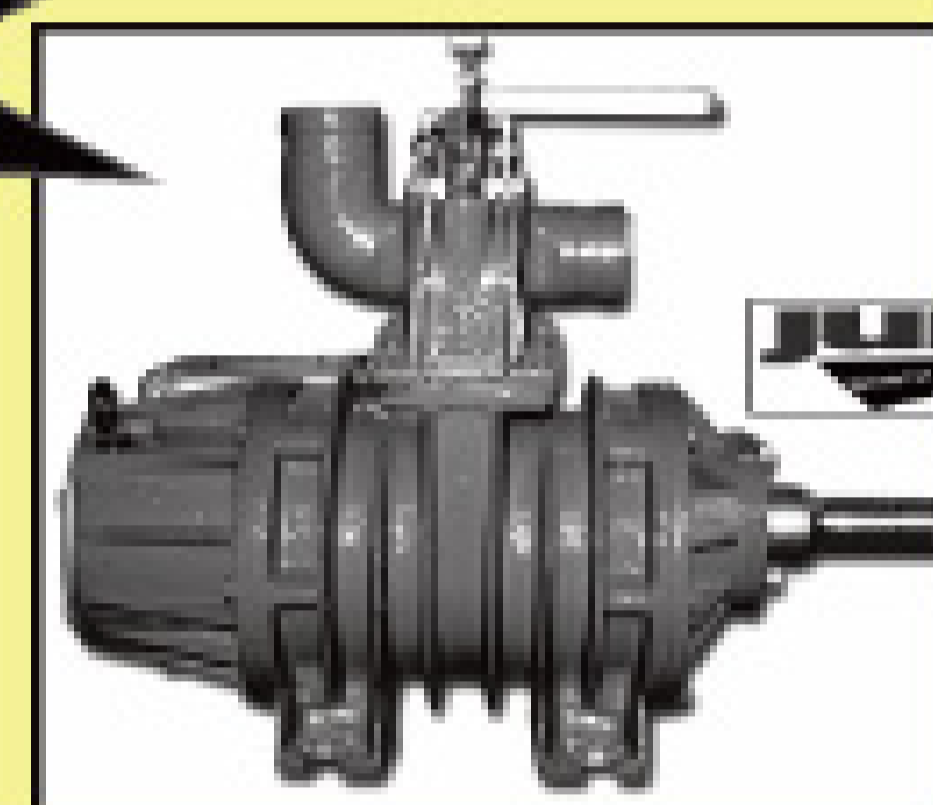

PN 33 PUMP

FOR 0-1000
GALLON TANK
STANDARD DUTY
APPLICATIONS

**FREE
CATALOG**

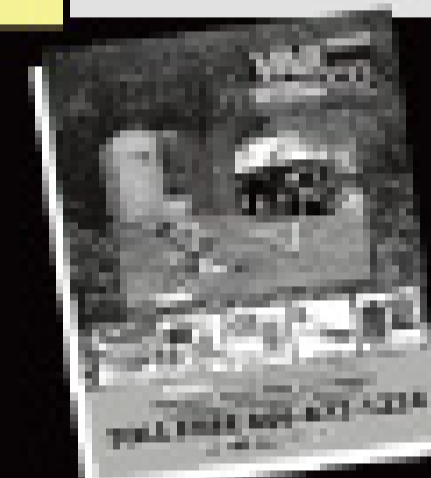

LOW, LOW PRICES - SAME DAY SHIPPING - FAMILY RUN!

TOLL
FREE

866-872-1224

SOURCE KEY
P2P8

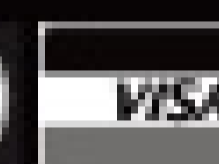

Non-CDL 19,500 GVW
Up To 66,000 GVW
Septic / Grease Trap
& Portable Restroom
Vacuum Service
Tank Trucks



Optional Tank Sizes Available On Your Choice of Chassis

Contact: Mark C. Langworthy **800-261-9009**
e-mail: mlangwor@tanktruckservice.com www.tanktruckservice.com
Tank Truck Service & Sales, Inc., 25150 Dequidre, Warren MI 48091

WHAT DO YOU NEED TO STOCK YOUR BUSINESS NOW?

- lower payments...
- longer terms...
- less interest...
- deferred payments?

Why limit your options to inflexible delayed payment plans when you can choose the options that are best for you?

FLEXIBLE FINANCING* on trucks, restrooms and hand-wash stations enables your money to work harder for your business.



Call your regional manager at **(800) 241-7951**
or visit **Booth 1140** at the Pumper Show



BOOTH 1140

* Flexible Financing options are provided by multiple third-party sources and are contingent on completion of a satisfactory credit application.



DRAGON

PRODUCTS, LTD.

PUMPS DIVISION

A Modern Group Company



Custom fabrication to meet our customers specific needs in the Petrochemical, Shipping, Drilling, Agricultural and Mining industries. All Dragon pumps, agitators, hoppers and pump packages are assembled in Liberty, Texas.

All internal pump parts such as bearings, shafts, and mechanical seals are from the highest quality parts and materials made in the USA.

We maintain a huge warehouse of motors by Baldor and Reliance and starters by Sprecher & Schuh/Allen Bradley.

We also have a full stock of replacement parts for your pumps which are 100% interchangeable with other popular pumps on the market. Dragon is the largest stocking dealer of **Fruitland Pumps and Parts** in the U.S.A.

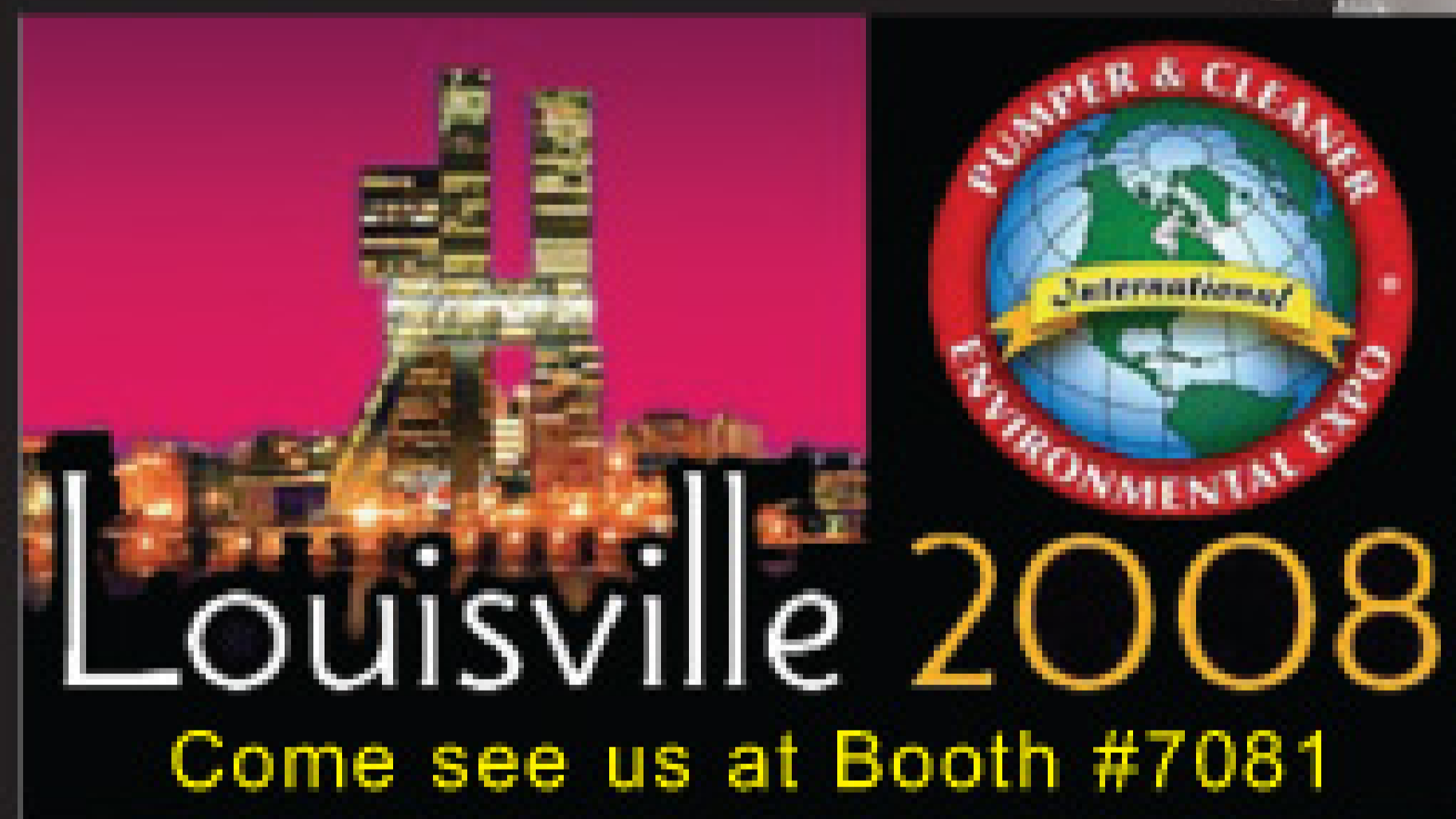

1-866-914-8198

email: sales@modernusa.com

website: www.modernusa.com



DRAGON

PRODUCTS, LTD.

A Modern Group Company

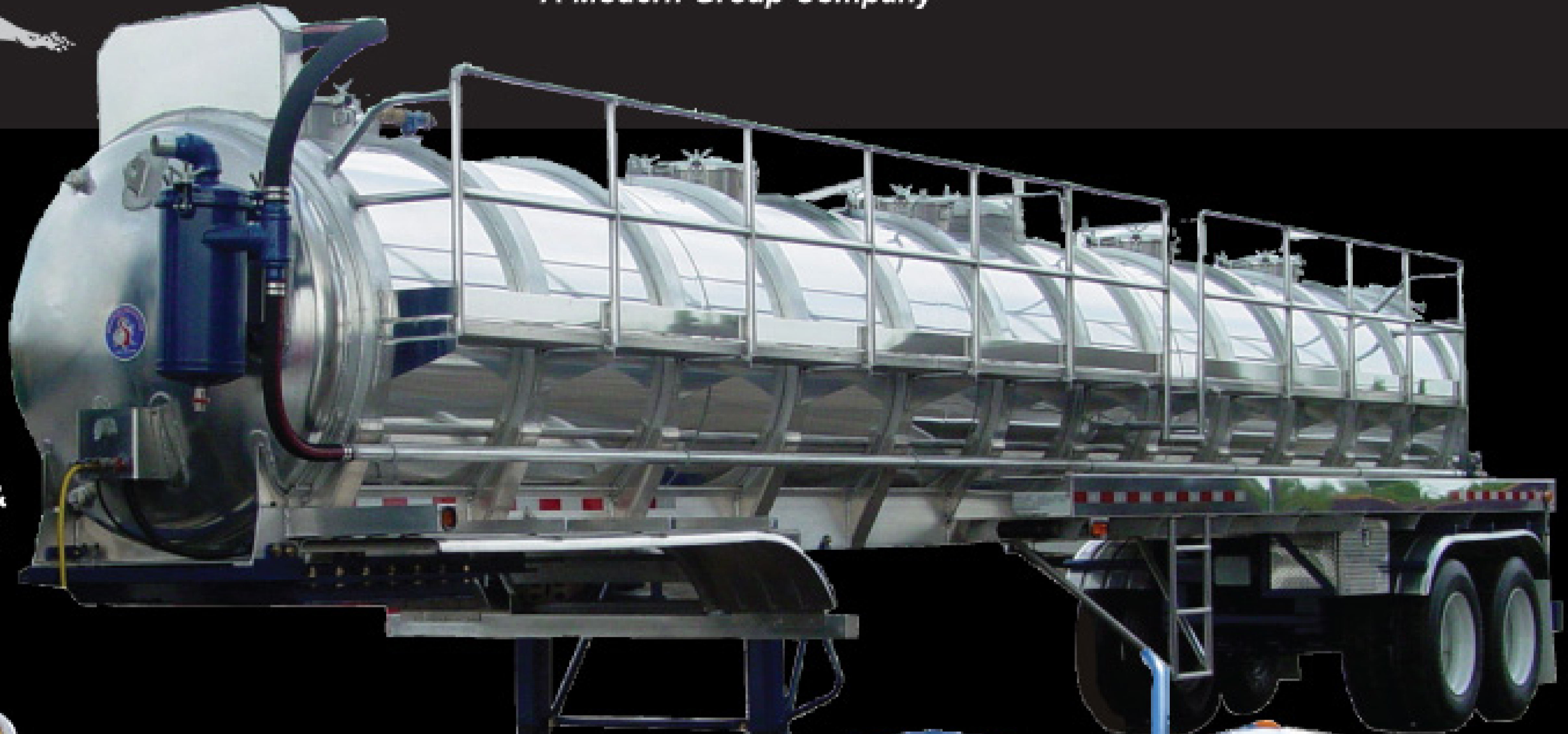

150 BBL ALUMINUM &
130-160 STEEL CODE
AND NON-CODE
VACUUM TRAILERS



30-80 BBL STEEL &
ALUMINUM BOBTAILS



SINGLE & TWO CONTAINER
ROLL-OFF TRAILERS



500 BBL LIQUID TIGHT
SMOOTH WALL CONTAINERS



Louisville 2008

Come see us at Booth #7081



VACUUM
ROLL-OFF
CONTAINERS



Looking for a Great Deal on Quality
Used Equipment?

Check out our web-site at:
www.modernusa.com

(877)778-4280

email: sales@modernusa.com



Ask about our easy
Credit Terms and
Convenient
Financing.

North Carolina Bill Would Have Required Two Technicians per Truck on Some Jobs

By **Scottie Dayton**

Doug Lassiter, executive director and lobbyist for the North Carolina Septic Tank Association, reports that the association's rapid action in the state legislature delayed a decision on an amendment to a bill that pumpers opposed.

A bill being heard in committee would have required pumpers to install effluent filters and risers on septic tanks at the time of pumping, if they weren't in place. Furthermore, the language did not address U.S. Occupational Safety and Health Administration confined-space regulations.

Association members said that, if passed, the proposal would have meant vacuum trucks would be required to carry

two technicians and transport excavation equipment and materials when making service calls, so that they could install the risers and filters when necessary.

As a result, says Lassiter, "A pump-out job that usually lasts an hour could turn into four hours. The cost to the consumer could more than triple, producing negative results for our industry and the legislators who voted for the amendment."

Lassiter says the association supports effluent filters and risers, but believes it is unreasonable for pumpers to install them as part of routine pump-outs. The association would prefer to see riser and filter installations handled as a separate job.

Lassiter and association

members called their legislators, expressing the desire to address the amendment in full and resolve all questions. Their efforts resulted in the language being pulled from the bill.

MICHIGAN

A bill requiring contractors to provide portable restrooms at residential building sites is awaiting action by the House Regulatory Committee, while a bill to amend the Michigan Vehicle Code is awaiting debate by the Senate Transportation Committee. That bill would regulate which vehicles could travel on what roads during which months.

During the last legislative session, language that would allow haulers access to secondary roads during spring thaw was vetoed. The Senate Transportation Committee is working to add other issues of interest to the bill to possibly avoid another veto. Preliminary meetings were held to develop the best approach to require local governments prohibiting land application to make a septage-receiving facility available within their boundaries.

RHODE ISLAND

The International Association of Plumbing and Mechanical Officials Property Standard has been replaced by an IAPMO/American National Standards Institute Z1000-2007 Standard for prefabricated concrete, fiberglass-reinforced plastic or polyethylene septic tanks. Besides establishing what constitutes acceptable quality, the standard includes requirements for design, materials, performance testing and markings.

"Rules and Regs" is a monthly feature in Pumper. We welcome information about state or local regulations of potential broad interest to onsite contractors. Send ideas to editor@pumper.com.

IAPMO/ANSI Z1001-2007, replacing IAPMO PS 80, establishes construction specifications for prefabricated gravity grease interceptors. Developed for producers, distributors, architects, engineers, contractors, installers, inspectors and users, it addresses design, materials, installation and marking/labeling for identifying prefabricated gravity grease interceptors that conform to the standard. Both can be purchased online at https://publications.iapmo.org/standards/pub_show_synopsis.asp?doc_id=312.

WASHINGTON

New onsite treatment rules now require conventional onsite systems to be inspected every three years and all other types to be inspected annually. Island County homeowners may inspect their systems after completing the County Public Health training program, provided the evaluation is not associated with a property sale, and provided the system is conventional and is not located in a sensitive or marine recovery area. In all other cases, the inspection must be done by a professional provider.

The State Department of Health is phasing in the rules over 18 months. County Public Health has initiated licensing for professional maintenance service providers. Training and certifying for homeowners begins early this year. Penalties for non-compliance range from \$25 a day for low-risk violations to \$250 a day for high-risk ones, but the health department imposes fines only as a last resort. No fines will be levied during the 18-month implementation period. ■



(800) 800-7575
 (713) 675-7575 • Fax (713) 675-2500
 Houston, TX
 710 McCarty Drive • Charlie McDaniel

See Our Inventory: www.amigotruck.com



2005 MACK CX613 VISION - E7 Mack 350 HP, 10 Speed, Camelback Suspension, 4.64 Ratio, 251" WB, All Steel Wheels, Tandem Axle, Double frame, NEW HydroVac, 3600 usg, D.O.T. 407/412, Hibon 820 blower 1400 cfm, hoist, full rear opening door, hydraulic vibrator, safety walkway, excellent truck. **Call for Price**



2007 FREIGHTLINER BUSINESS CLASS M2 - 106 MBE 600 Mercedes 300 HP, 9 Speed, Air Ride Suspension, 3.58 Ratio, 232" WB, All Steel Wheels, Tandem Axle, New Cusco 70 barrel D.O.T. certified vacuum, full opening rear door, hydraulic dump, Moro PM100 460 cfm pump, vibrator, double frame, excellent truck. **Call for Price**



USED 2001 MACK CH613 - Tandem Rear Axles, E7 Mack, 300 HP, 4.64 Ratio, Air Ride Suspension, 9 Speed; 275" WB, All Aluminum Wheels, Double frame, 44K rear, 14K front, New Cusco commercial aluminum vacuum tank, 4000 gal. capacity, Moro PM100 air cooled vacuum/pressure pump, 460 CFM, Stock # 6261. **Call for Price**



2001 MACK CH613 - E7 Mack 300 HP, 9 Spd OD, Air Ride Suspension, 4.64 Ratio, 262" WB, Aluminum/Steel Wheels, Tandem Axle, Double frame, New Cusco Aluminum Dump Commercial Vacuum, 4000usg, rear lifting door, MORO PM100 air cooled pump, 460CFM rating. **Call for Price**

"Heavy Duty Headquarters"



**Appearance
Performance
Quality
Since 1939**

Conde PowerPaks

More Power To You

**Conde gas powered vacuum units
are compact, powerful, and
ready to install for instant vacuum**

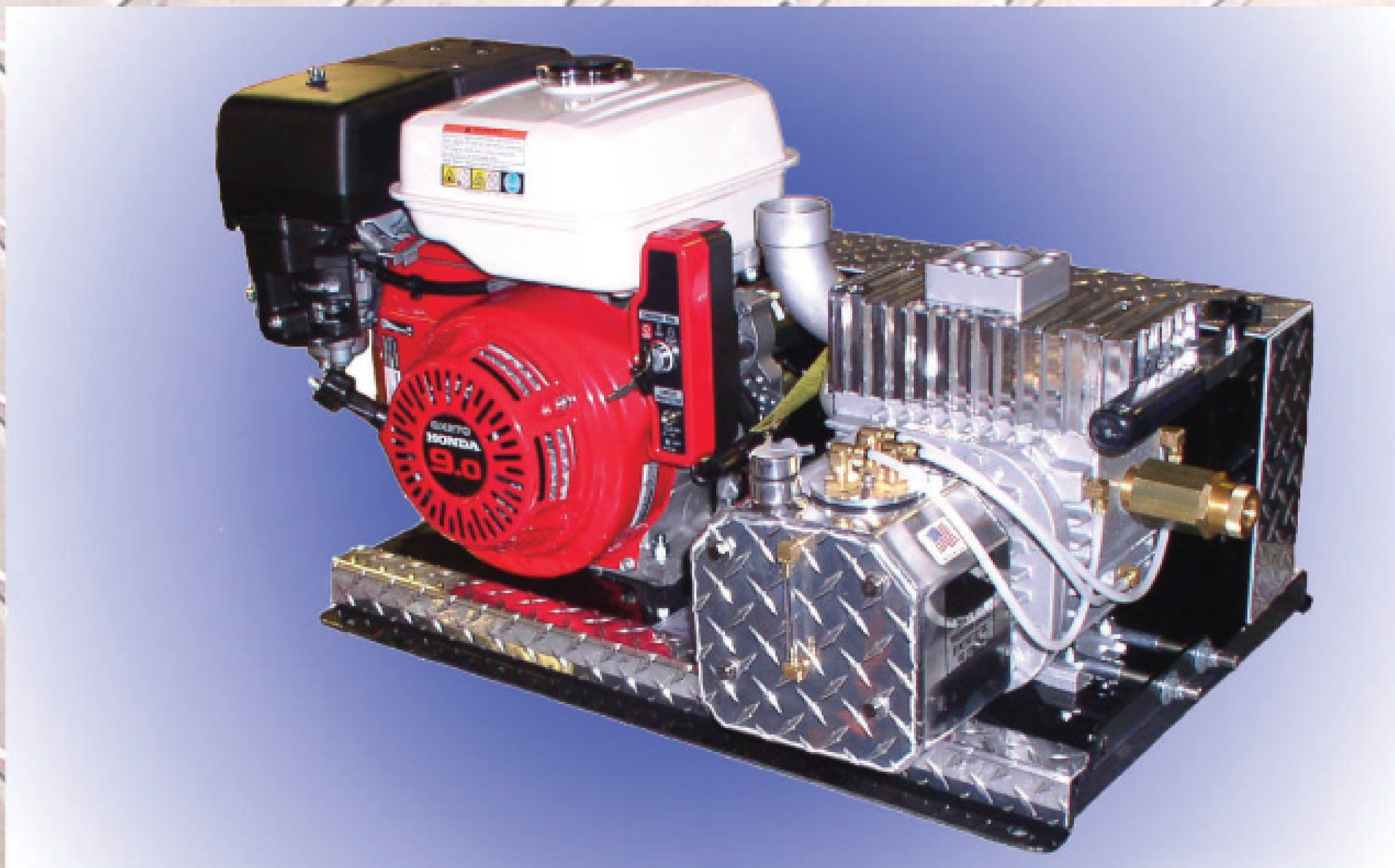

Booth 8109

Westmoor Ltd.

P.O. Box 99
Sherrill, New York 13461

Call Toll Free 1-800-367-0972

On The Web At: www.westmoorltd.com E-mail: pumps@westmoorltd.com

It's like free cash from Hampel.



No monthly payments until June 2008.
Zero % interest, free financing.

Take advantage of this limited time offer on the world's most durable portable restrooms –
the 1.5, Country Classic and Global from Hampel*.



Engineered for strength, durability and value.

www.hampelcorp.com • 800-549-1558



The Country Classic



The 1.5

Limited Time Only,
Call Today!

West – Jim McCoy
800-549-1595

Midwest – Jeff Peltier
800-549-1596

Northeast – Patrick VanTyle
800-549-1594

Southeast – Brian Sorensen
800-549-1598

Corporate
800-549-1558

Hampel Corp. features the most rugged and durable restrooms available.

Whether you're serving the construction industry, high-end special events or anything in between – Hampel has a restroom for all your needs.



Booth 4171



The Global

Call Today!
1-800-549-1558

*For qualified buyers only.
Call for details.

T&T TOOLS

T&T TOOLS, Inc.

FAX: 800.521.3260 | EMAIL: sales@TandTtools.com

800.521.6893

www.TandTtools.com

CALL FOR A FREE CATALOG!

CALL FOR A FREE CATALOG!

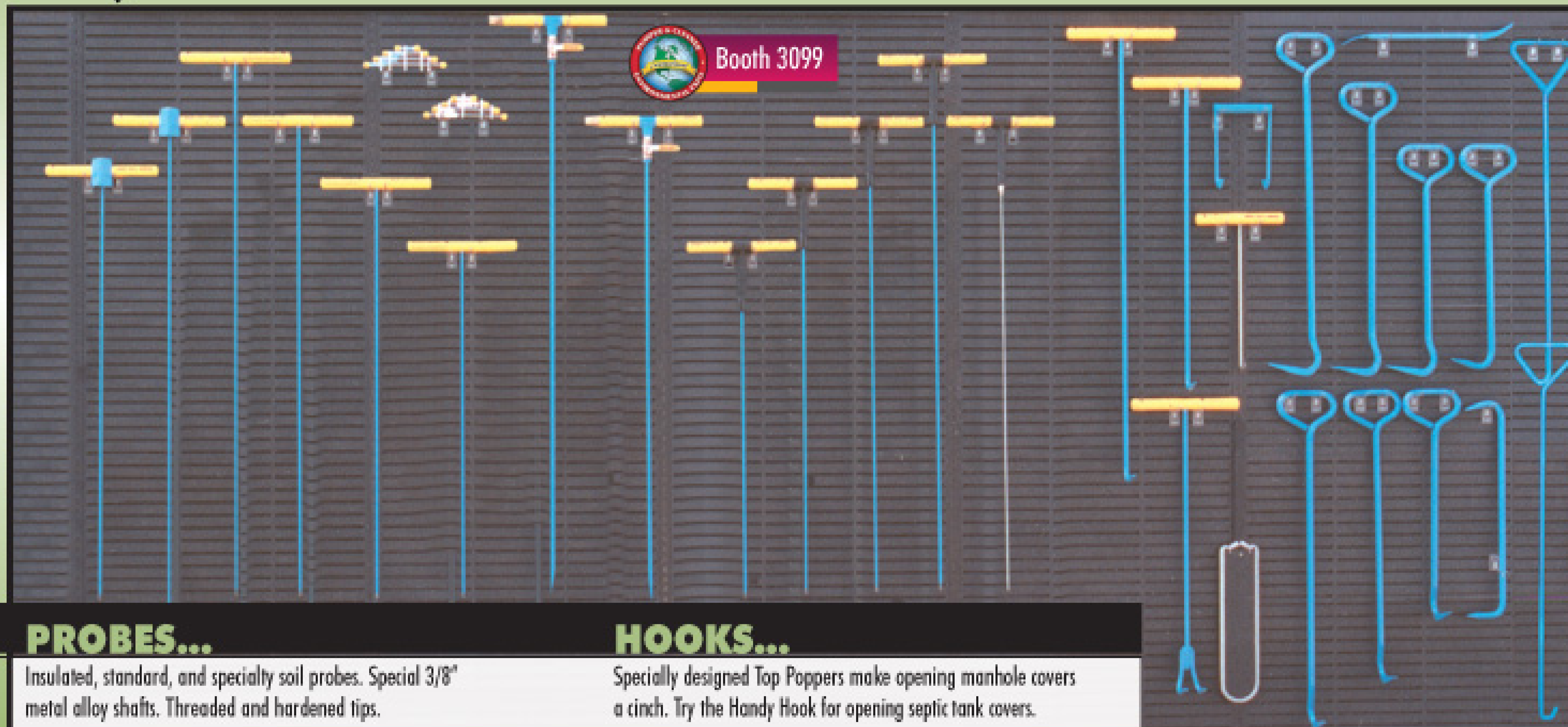

PROBES...

Insulated, standard, and specialty soil probes. Special 3/8" metal alloy shafts. Threaded and hardened tips.

HOOKS...

Specially designed Top Poppers make opening manhole covers a cinch. Try the Handy Hook for opening septic tank covers.



1-800-333-9274 East * 1-800-786-9274 Custom
 1-800-351-7283 HONDA Parts * 1-800-964-9274
 1-800-454-9274 Open Till 7:00pm West

- * Apply For 30 Day Terms Account
- * Low Interest Lease Plan
- * 5 Offices To Serve You
- * Free Lifetime Tech Support

<p>SWIVELS</p> <p>Mosaic & Super Swivels \$22.10 & Up</p>	<p>BYPASS VALVES</p> <p>From 500-7000PSI 120 Models In Stock \$19.99 & Up</p>	<p>TRIGGER GUNS</p> <p>Extreme Duty From \$7.99 & Up</p>	<p>HOSE REELS</p> <p>200' Manual Reel \$79.99</p>	<p>Portable Hose Reels</p> <p>250' \$299 350' \$349</p>	<p>HOSES</p> <p>Up To 5800PSI 316Deg F. Rated Up To 200' \$29.99 & Up</p>	<p>TURBO NOZZLES</p> <p>Up To 5800PSI Best Seller 4500PSI Only \$39.99</p>	<p>PRESSURE GAUGES</p> <p>Stainless Steel Industrial Quality Up to 6000PSI Only \$23.99</p>	<p>BALL VALVES</p> <p>Ball Valves Brass, Steel & Stainless Steel New 6000PSI Stainless From \$23.99</p>
<p>Honda Engines</p> <ul style="list-style-type: none"> * 5Hp GC \$199 * 6.5Hp GX \$349 * 8Hp GX \$459 * 9Hp GX \$489 * 18Hp GX \$1,099 	<p>Honda Twins</p> <ul style="list-style-type: none"> * 18Hp GX610K1 \$1,099 * 20Hp GX620K1 \$1,279 * 24Hp GX670T \$1,599 	<p>Compact Electric Hand Carry</p> <p>\$649 EHC2015G 2GPM @ 1500PSI</p>	<p>Compact Honda Hand Carry</p> <p>Includes Pulse Valve \$799 HJ3028HC 3GPM @ 2800PSI</p>	<p>Hose Reels All Types Available</p> <p>200' Portable As Shown \$165.98</p>	<p>LT Replacement Engines</p> <p>Recoil & Electric Start Available</p>	<p>CAT Pump Volume Distributor</p> <p>Complete Pumps Plumbed From \$179</p>		
<p>Customized Electrics</p> <p>Auto Stop/Start Hose Reels, Etc</p>	<p>BEST Sellers ALWAYS on Sale</p> <ul style="list-style-type: none"> 5.6GPM @ 4000PSI \$399 8.0GPM @ 3500PSI \$499 7.0GPM @ 5000PSI \$599 <p>Call For Free Quotation. We Also Stock Pumps With Left Hand Drive, Tapered Shaft, Car Wash Duty, 316 Stainless Steel and Unique Applications 1-800-964-9274</p>	<p>High Performance AR Pumps</p> <ul style="list-style-type: none"> 13GPM @ 1450PSI \$579 11GPM @ 3000PSI \$629 5.8GPM @ 7250PSI \$1,099 10GPM @ 7250PSI \$2,899 44GPM @ 1500PSI \$4,199 <p>We Stock 1000's of Pumps For Same Day Shipping!</p>	<p>New On Board Hose Reel Option</p> <p>50' x 100' Available On Some Models</p>	<p>Hose Reels Up To 350' Capacity</p> <p>Jetter Packages Available All Sizes</p>	<p>Replacement Pumps</p> <p>1-800-454-9274 Up To 41GPM Up To 7250PSI</p>	<p>Replacement Coil Specialists</p> <p>For Hot Water Pressure Washers</p>		
<p>Truck or Trailer Mount</p> <p>Skid Mount & Tank Feed Options Available On Some Models</p>	<p>Hydraulic Drive Pressure Washers</p> <ul style="list-style-type: none"> 3.0GPM @ 2000PSI \$539 4.0GPM @ 2200PSI \$649 4.0GPM @ 3000PSI \$689 <p>Call For Details & Hydraulic System Requirements 1-800-454-9274</p>	<p>Cleaning Heads</p> <p>Full Line Of Cleaning Heads Available</p>	<p>Up To 8GPM Hot Boxes</p> <p>Adjustable Thermostats, Jumper Hoses & Options Available L.P. Diesel Models Available</p>	<p>HONDA Best Seller</p> <p>\$2,999 4000PSI Hot 4040HG-115</p>	<p>Frames & Frame Parts Available</p> <p>Belt & Direct Drive With Custom Options</p>	<p>Mobile Wash - Detailer System</p> <p>Self Contained On Board Water Supply</p>		

VACUTRUX



#7048 & 7049



Industrial vac



Supertrux



Septic pumper



Routetrx



Industrial vac

Call today to discuss your equipment needs!



Maxitrx



**Phone
(800)-305-4305**

53 ARTHUR ST. ELMIRA, ONTARIO, N3B 2Z7 fax (519) 669-8331 salesinfo@vacutrux.com

Black Tie Manufacturing Now Offers 8' Restroom Trailers Starting at \$13,900!

Unlike our competitors,
Black Tie
standard features include:

- Stair System
- AC/Heat Strip
- Waste Tank
- Hot Water Tank

We CUSTOMIZE and offer
attractive Financing Programs.

Call **877-253-3533**

www.blacktiemanufacturing.com/diamond



Sample floor plans

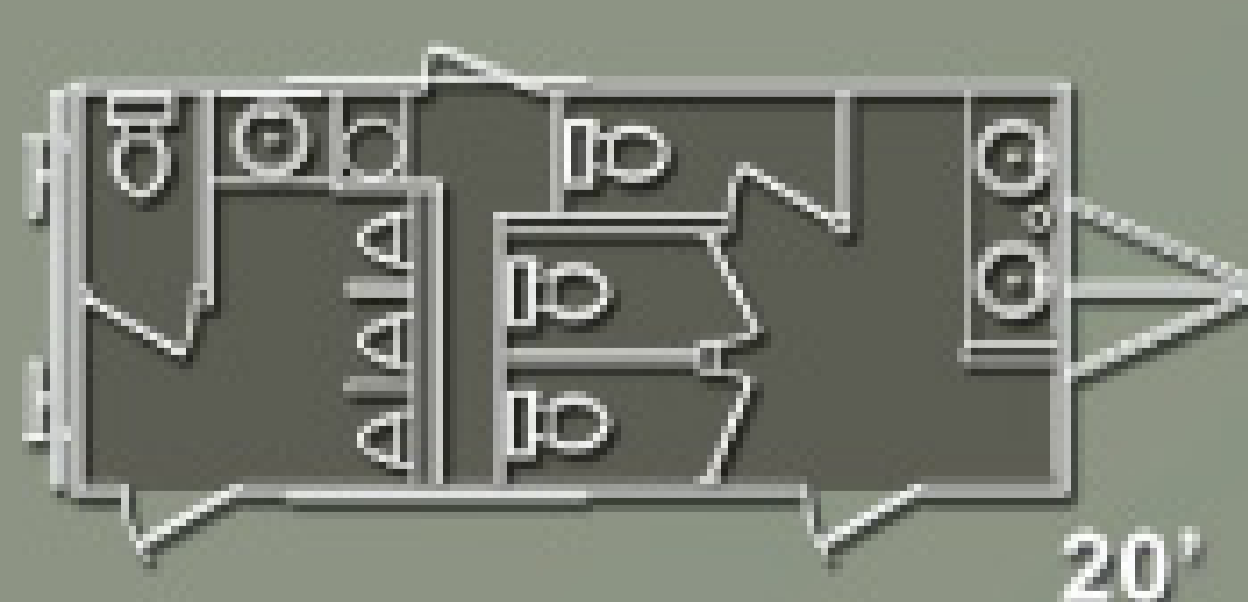
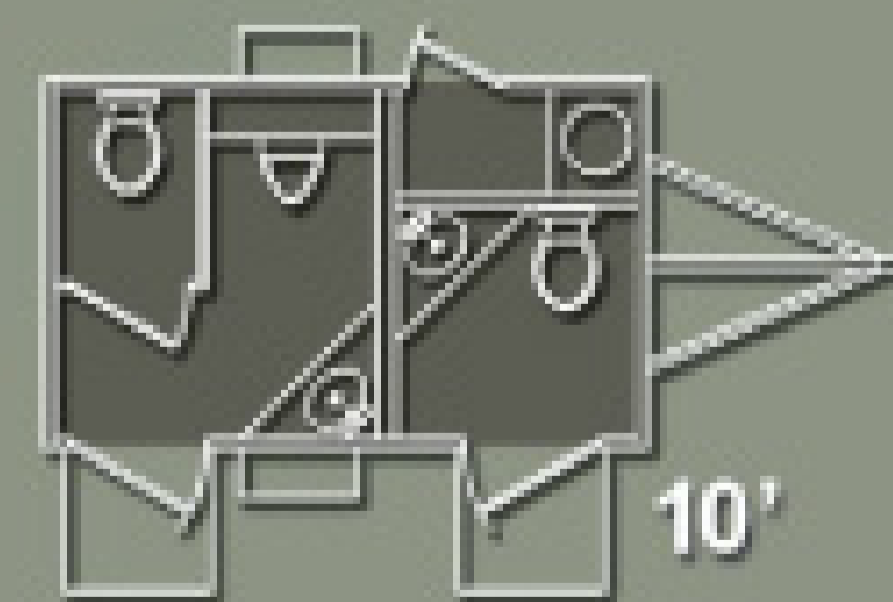
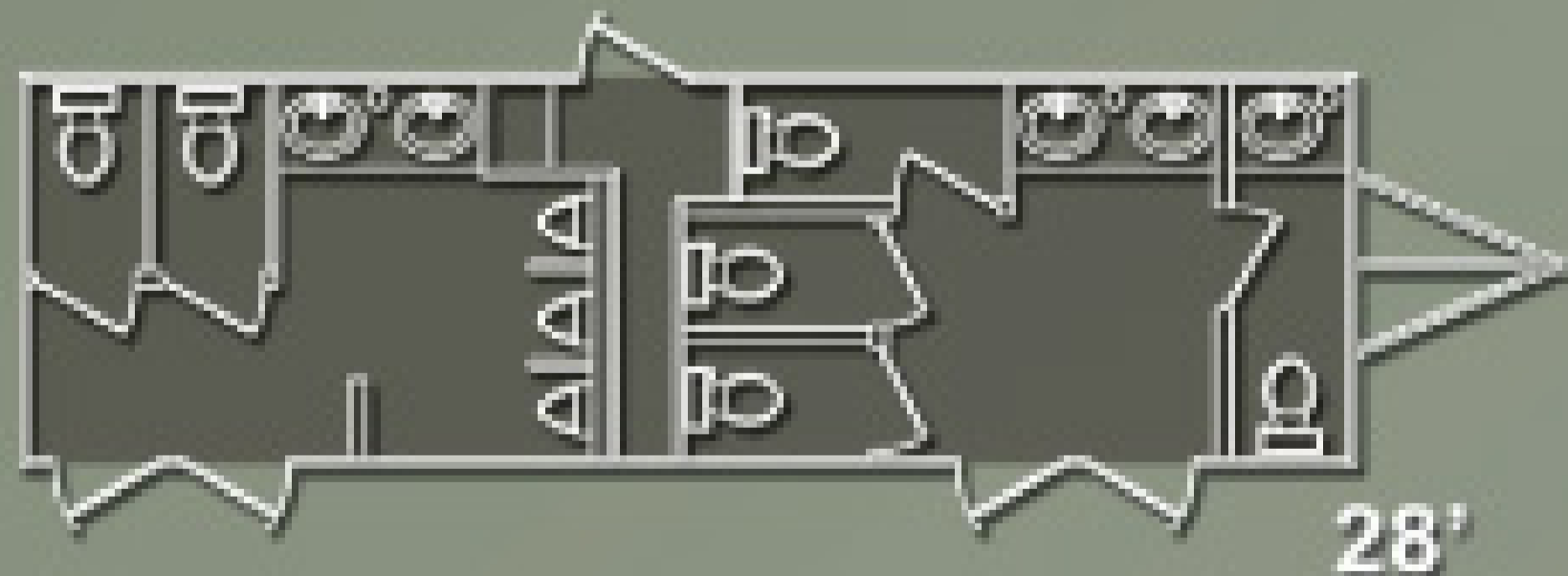
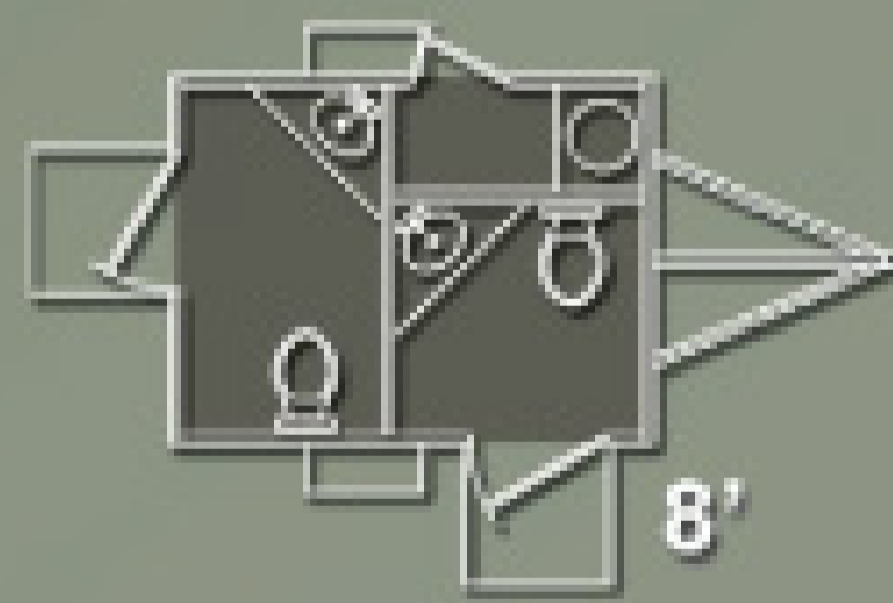
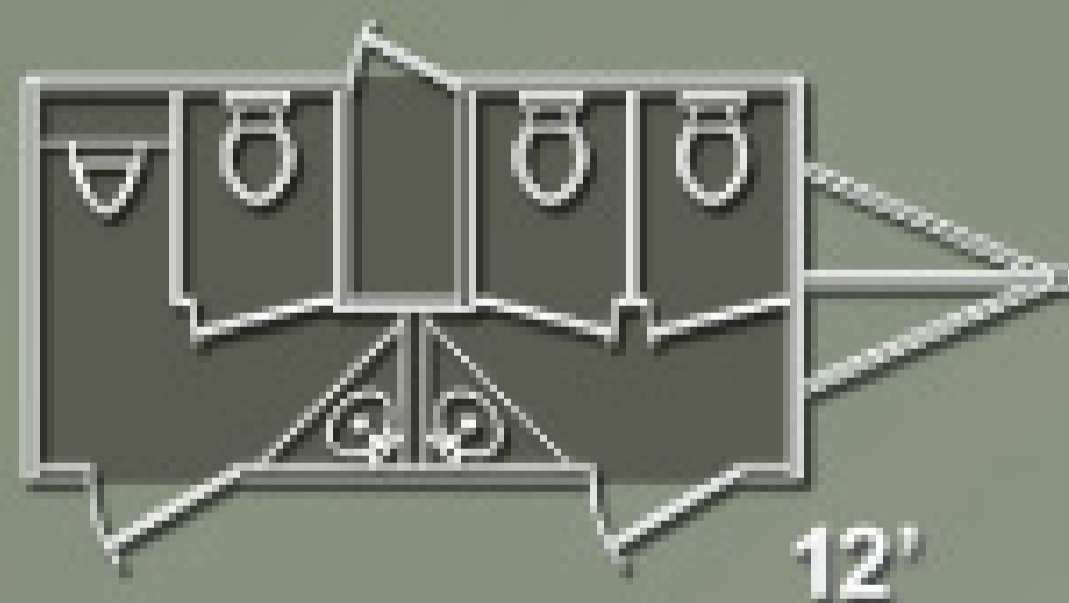

© 2007 BLACK TIE MANUFACTURING, INC.

Introducing the **BLACK TIE**

Re-Rental Program

BTM

Black Tie Manufacturing (BTM), the nation's leading manufacturer of quality mobile restroom and shower suites.

BTES

Black Tie Event Services (BTES), the nation's leading provider of mobile restroom and shower trailers.



When BTES needs additional equipment, BTES calls your company and provides you with an opportunity to rent your BTM trailer to them. Your participation could include all sanitation services.

RESTROOM RENTAL COMPANIES

If your customer's event requires more restrooms than you own, call BTES to provide your company with the trailers you need.

BTES Partners

"Current owners of BTM equipment"

When you purchase a mobile restroom trailer from Black Tie Manufacturing (BTM), you become a rental resource of our affiliate Black Tie Event Services (BTES). Your equipment purchase automatically enrolls you in Black Tie's exclusive Re-Rental Program, which increases your opportunity to generate higher rental revenue. No other manufacturer can offer you this unique opportunity.

"Black Tie and You. It's a Jewel of a Relationship!"

Call **877-253-3533**
toll free

* Attractive Financing Programs Available



BLACKTIEMANUFACTURING.com/diamond
show@blacktiemanufacturing.com

Visit us at
BOOTH 7179



THE BUCK Stops Here

The thrill of calling the shots draws entrepreneurial Oregon couple into septic service ownership as a second career

By Seiche Sanders

Frank Wood of La Pine Septic Service works the valves on the back of his 2004 Peterbilt vacuum truck at a jobsite. (Photos by Kulpinski Photography)



Profile

La Pine Septic Service

La Pine, Ore.

Owners: Frank and Teresa Wood

Yrs. in business: The Woods purchased the 3-year-old business in 2006

Employees: 4

Services: Septic pumping and portable sanitation

Service area: 60-mile radius, covering central Oregon, all of Deschutes County and Northern Klamath County

Web site: www.LaPineSepticService.com



“I’m not used to backing up; I want to go forward,” says Teresa Wood as she navigates her pickup truck in reverse while delivering portable restrooms to a customer. It’s late on a Friday afternoon, and Wood is making an emergency last-minute stop at a local sports arena. Afterward, the remaining units onboard will be delivered to the local high school. Even though she hadn’t intended to spend her afternoon this way, Wood is grateful to be doing what she’s doing — and doing it on her own terms.



La Pine employee John Bales and owner Teresa Wood say hello to Wood’s Boston terrier Katie, while reviewing the day’s restroom service route.

“FROM THE SMALLEST ORDER TO THE LARGEST, CUSTOMERS ARE ALL VERY IMPORTANT TO US. NOT JUST MONETARILY, BUT AS PEOPLE ALSO. YES, IT’S A VERY PEOPLE-ORIENTED BUSINESS. YOU’VE GOT TO LOVE THEM.”

Teresa Wood

Wood's comment could just as easily describe the long road she and her husband, Frank, took to realize their dream of business ownership. Today, the couple are the owners of La Pine Septic Service, a full-service liquid waste and portable restroom rental company located in La Pine, a town of 1,585 in central Oregon. (The population of the greater metropolitan area is about 10,000.)

The road getting to this point, however, was a long one. The couple, now both 49, yearned for this day for as long as they can remember. They had to work hard, but always had the goal of business ownership at the front of their minds.

The Woods, high school sweethearts who married at 16, had long careers in unrelated industries while they raised their two children — a daughter and son. Finally, in 2006, their big break came when an opportunity to go into business for themselves fell into their lap.

"Ever since we were young we would have rather had our own business, but the opportunity never showed itself," Teresa Wood says.

Teresa worked in accounts receivable and collections for 20 years for a building materials wholesaler, while Frank was an auto parts manager and service director for car dealerships for 23 years. Both were successful in their own right, but the work was never as gratifying as they dreamed it could be. Each of their vocations, however, prepared them in more ways than they knew for the challenges inherent to business ownership.

"We gleaned as much as we could from the corporate world, and brought that into owning our own business," she says. "It's a small company, but we brought many of those ideas into La Pine."

RIGHT PLACE AND TIME

As the saying goes, timing is everything, and that was the case for the couple leading up to the purchase of La Pine. The Woods'



At the top, (from left) Bernard Gonzales, Frank Wood and John Bales (father of Wood's employee of same name) chat while dumping a load from Wood's 2004 Peterbilt service truck at the La Pine Sewer District. Below, Wood returns a hose to the truck after a septic-pumping job. At right, he prepares to pump a tank.



son-in-law, a local contractor (and now, also a customer), was talking with La Pine's former owner when he expressed interest in selling the business. The couple jumped at the chance, and the sale was final less than three months later.

Coincidentally, it was not the first time Teresa and Frank Wood had encountered La Pine. The company, under its previous ownership, had been called to their rental house at the time, when they reported a septic backup to their landlord.

"The previous owner was cordial and came in on a weekend," Teresa remembers. She and Frank continue that brand of 24/7 customer service today — happy to answer emergency calls on weekends, when necessary.

The couple also continues to focus on living up to the reputation the former owner

built. Giving customers the same level of quality service was an important goal. They also attribute some of their good fortune to luck.

"Everything fell into place with the finances and having a wonderful owner who was willing to help us learn to pump the septic tanks right." Teresa adds that the former owner taught her husband the right way to do things, allowing the couple to pick up where he left off and meet and exceed customer expectations to this day.

SMOOTH TRANSITION

During his years in the auto industry, Frank Wood had always had a knack for taking parts and service departments from barely breaking even to profit centers that generated more revenue than vehicle sales. That drive to succeed and an appreciation for good cus-

tomer service served as building blocks for business ownership, as he was able to apply much of what had made him successful to running La Pine Septic.

"We strive to provide the cleanest toilets possible and the best customer service possible," Teresa says. "We treat all of our customers the way we would want to be treated by any other company."

The pair also make it a point to never lose sight of what this business is about. "From the smallest order to the largest, customers are all very important to us. Not just monetarily, but as people also. Yes, it's a very people-oriented business," she adds. "You've got to love them."

When La Pine's previous owner turned over the reins, ensuring the transition was seamless for customers became the Woods' top priority.

They negotiated the use of the company's existing phone number, which meant the calls kept coming in without interruption. They also retained the business name so as not to confuse customers. Finally, they very publicly announced the transition, and vowed to uphold the service customers had grown to value and expect.

"There's a local paper here that everyone in La Pine picks up. We took out a full page ad that had a letter from the previous owners saying goodbye, and introducing us," Teresa says. "That way, they knew they weren't being left in a lurch. It was important to the community to let them know."

GOOD EQUIPMENT

Her customer service background also eased the transition:

"I was able to ease any reservations that the customers might have with the change in

ownership. We also were able to keep the employee the original owner had, and in doing so, the service was not interrupted." The Woods' 27-year-old son, Frank Joseph, "Joe," also joined the team as a full-time employee.

"We have had several customers comment on how smooth the transition went — that it was barely noticeable. They have also stated that the service has even stepped up to a higher level than it was in the past."

Along with the business, the couple acquired a 2006 Peterbilt 335 truck for portable sanitation built by FMI Truck Sales & Service, with an 1,700-gallon waste/800-gallon freshwater stainless steel tank; and a 2004 Peterbilt 330 from Pacific Truck Tank Inc. with a stainless steel 3,600-gallon waste/200-gallon freshwater tank. They have since purchased a 1997 Ford F-350 flatbed pickup, which carries a 400-gallon waste/200-gallon freshwater stainless steel tank; and a 2006 Dodge Ram 3500 SLT pickup for hauling portable restrooms.

"We needed four-wheel-drive to make it up some of the mountain terrain to the job-sites of our contractors in the snow and ice. We service year-round, be it sun, rain, snow — which can be four to seven feet — and ice; we will be there once or twice a week as ordered by our customers," she says.

The portable restroom inventory includes

"WE HAVE A WEB SITE THAT DOES WONDERS FOR REACHING THE PEOPLE OUTSIDE OF THIS AREA. WE HAVE PEOPLE GIVE US A CALL THROUGHOUT OREGON AND WASHINGTON, AND MOST OF THEM LOCATED US OVER THE INTERNET."

Teresa Wood



268 standard and nine handicap units, six wash stations and five trailer-mounted units. All are from Synergy World Inc.

UP TO SPEED

Forging a strong relationship with La Pine's former owner was essential in navigating the learning curve in an industry that was completely foreign to the new owners. Thankful for the seller's help, they took the previous owner and his wife out for a steak dinner when the deal closed.

"He (joked), 'Good luck, and we're here if you need help, but we hope you never call.' And we've never had to," says Teresa.

That's where good training leading up to the final sale paid off.

"Frank drove with the owner for several weeks — he's a really great guy. We really appreciated him a lot in how he showed Frank how to take one of the Peterbilts into the tightest places, and these aren't small trucks.

"We were able to make the transition very easily since the previous owner was accompanying Frank with the routes for the first month



Joe, Teresa and Frank Wood (from left) pose in front of their fleet of service trucks behind their home in La Pine, Ore.



Wood explains a pumping bill to customer Heidi Cross. Teresa and Frank Wood hit the ground running when they took over an existing septic-cleaning business in La Pine, Ore.



Employee John Bales services restrooms in Sunriver, Ore., using a Ford F-350 service truck with a 400-gallon waste/200-gallon freshwater tank.



La Pine Septic maintains a fleet of Synergy World Inc. portable restrooms. Here, Bales cleans units on his daily route.

that we had the business," she adds. "He introduced Frank to every contractor that we came in contact with and helped him pump septic tanks so that he would do the job right the first time."

A "fantastic" payroll clerk on the La Pine Septic team has also helped Teresa stay on top of the books.

These combined forces have been effective, allowing the new owners to grow the business 15 to 20 percent since purchasing it just over a year ago. Currently, the septic pumping business services 85 percent residential and 15 percent commercial customers.

Still, the Woods face hurdles as new business owners. Because they've been in business such a short time, it's difficult to get financing for capital expenditures, such as new trucks or more equipment.

"All financing places want you to be in business for at least two years in this type of business," she says. The Woods have had to rely on personal savings for the purchases they've made thus far. Teresa looks forward to a day when their credit allows them to purchase more trucks or tanks so they are prepared for more calls, within a larger geographic range.

MOVING AHEAD

Their son-in-law's status as a local contractor has helped them secure some business, too — he gets the word out. "In the beginning, that really helped." Word-of-mouth has been the Woods' best marketing tool; their Web site has been a close second.

"We have a Web site that does wonders for reaching the people outside of this area. We have people give us a call throughout Oregon and Washington, and most of them located us

over the Internet."

While the Woods can easily put in 60- to 70-hour weeks in the warmer months, they still value their newfound freedom to work when they want to, all the while knowing that every effort they make is rewarded.

"What we put into the business is what we get out of it. Energy, time, finances — all directly correlate with what you get back.

"We love the freedom," she adds. "And we know that as we get larger, we'll have more of that."

High standards of customer service and a solid reputation have put La Pine on the fast track to growth. Finding a successful transition strategy was a start, but there's one big factor they say is essential in this business:

"Always putting the customer first," Teresa says. "Just like the deliveries I'm making now. They called two weeks ago and said they might need this delivery. They called this morning, after I already sent my drivers out and said they needed it and asked if there was any way I can do it."

The answer is — almost without fail —

yes. "We try to meet the needs as they come," she says.

"And I always try to meet the requests with a smile."



MORE INFO:

FMI Truck Sales & Service

800/927-8750
www.fmitrucks.com

Synergy World Inc.

800/352-1986
www.portabletoilet.net

GET MORE JETTER FOR YOUR DOLLAR!

Working well under pressure!



Booth 3069



STB2511H-MAX

Full Featured Jets with Powered Reels:

SK4007V 23 h.p. Briggs 7GPM @ 4000 PSI... \$9950

STB2511H 24 h.p. Honda 11 GPM @ 2500 PSI... \$11699

SK3012K 29 h.p. Fuel Injected Kawasaki 12 GPM @ 3000 PSI... \$13995

STB2020V 35 h.p. Briggs 20 GPM @ 2000 PSI ... \$19699

STB4018DT 19 h.p. Hatz Quiet Diesel 18 GPM @ 4000 PSI... \$39950

Trailer Models starting at \$7499

www.camspray.com

800-648-5011

HOSE ASSEMBLIES

MANUFACTURED TO YOUR EXACT HOSE REQUIREMENTS BY THE LEADING SOURCE IN HOSE FABRICATION.



Visit us at Booth #3137 in Louisville, KY. to receive a free Mini-Baseball Bat & a discounted pass to the Louisville Slugger Museum when you place an order.



Always **FREE** with every order.

PAIR of DOUBLE PALM LEATHER WORK GLOVES

LOWEST PRICES GUARANTEED ON ALL OF OUR

"QUICK-SHIP"
ITEMS

Genuine

Kanaflex®

Assembled by

ABBOTT

300 EPDM HOSE NOW AVAILABLE IN COLORS

GREEN/BLACK - BLUE/BLACK - RED/BLACK



RUBBER COMPANY, INC.

1700 Nicholas Blvd. Elk Grove Village, IL 60007

www.pumperhose.com

1-800-852-1855 FAX: 847-952-0156

sales@pumperhose.com

MORCON, INC.



Booth 19031

CALL 518-677-8511 FOR A DISTRIBUTOR NEAR YOU.

MORCON Manufactures the **VALAY** and the **MOR-SOFT MILLENNIUM ULTRA ROLL**. We are a leading

manufacturer of the small core bath tissue and other specialty rolls designed for the portable restroom industry. Dispensers (plastic and metal) are also available.

-
- M125 – **Mor-Soft** 2500 Count 1 ply bath tissue 1/4" core, 24 per case
- M250 – **Mor-Soft** 1250 Count 2 ply bath tissue 1/4" core, 24 per case
- M2000 – **Mor-Soft** 2000 Count 1 ply bath tissue 7/8" core, 24 per case
- M1500 – **Mor-Soft** 1500 Count 1 ply bath tissue 1 1/4" core, 48 per case
- M304 – **VALAY** 2500 Count 1 ply bath tissue 1/4" core, 24 per case
- M802 – **VALAY** 2500 Count 1 ply bath tissue 7/8" core, 24 per case
- M340 – **VALAY** 1250 Count 2 ply bath tissue 1/4" core, 24 per case
- M803 – **VALAY** 1250 Count 2 ply bath tissue 7/8" core, 24 per case

**America's Sales Leader In Aluminum
Truck Mounted Tanks & Tank Trailers**
nationwide - worldwide

**Stock Tanks & Trucks
Financing & Lease Plans**



1-800-971-7657

www.tstllc.com

email us from our website



Booth 4053

See It At
The **Pumper Show**
In Louisville

3800 2-Compartment ASME/DOT Code



Not Actual Photo

Wittig RFW150 liquid cooled 500

CFM pumping system

10 GPM Jetter System

2nd compt non-code

2008 International

310 HP - DT310 engine

10-speed transmission

16,000 front axle

40,000 air ride rear axle

Polished aluminum wheels

\$156,000

As Low As \$3,120 mo.

Stock #25443

2800 2-compartment 2500/300

Masport HXL400WV 400 CFM

10 GPM Jetter System

Electronic liquid level indicator

Odor reduction system

Remote Operator

(Controls vac pump,
jetter pump, throttle and
emergency stop)

2007 International

245 HP DT466 engine, 6-speed
transmission, ABS air brakes

\$97,235

As Low As \$1,944 mo.

Stock #23890



Not Actual Photo



2008 Peterbilt 330

Cummins engine

Automatic Transmission

Air Brakes

AC and AM/FM

2000 Gallon

1500 Waste - 500 Fresh

Masport HXL4,

Burks DC-10 washdown ,

Hot Shift P.T.O w/ remote

\$83,900 As Low As \$1,151 mo.



• No Financials Required

Application Only to \$250K

• No Age Restrictions

Used Equipment (30+yrs still ok)

• Seasonal Payment Plans

- Bucket Machines
- Cable Machines
- Catch Basin Cleaners
- Combo Sewer Cleaners
- Dewatering/Composting
- Hydro Excavators
- Jetters
- Liquid Vacuum Trucks
- Trailer Mounted Combo
- Sweepers
- Vacuum Loaders
- and much more.....*

• Working Capital

Start-Ups Welcome

• Sale Leasebacks

Simple One Page Application

• Private Party Sales

ACG IS A FULL IN-HOUSE LENDER. OUR TEAM OF PROFESSIONALS PROVIDE SAME-DAY DOCUMENTATION AND FUNDING. LET US STRUCTURE A PROGRAM THAT BEST FITS YOUR BUDGET WITH INSTANT CREDIT DECISIONS. LESS THAN PERFECT CREDIT (FICO 580+) IS APPROVABLE!



Bryan Joy 800-830-0084 x214

9436 Hamilton Dr. • Mentor, Ohio 44060 • Fax 800-830-9855 • www.1acg.com

Big Fish

ENVIRONMENTAL

Receiving & Processing
For

Septage • Biosolids, Fats, Oil & Grease

Design • Build

P.O. Box 528 • 12608 Taylor Rd.
Charlevoix, MI 49720

PH: 231.547.4429 • FAX: 231.547.2057

www.bigfishenvironmental.com

TRUCK TOWN

2601 East Hwy. 80 • Abilene, Texas 79601

FULL SERVICE VACUUM SYSTEMS SUPPLIER



1-800-727-0350

**GOOD ASSORTMENT OF CUSTOM SPEC TRUCKS
FOR YOUR VACUUM UNIT NEEDS**

LELY SEPTIC & OIL FIELD VACUUM TRUCKS
TROXELL TRAILERS

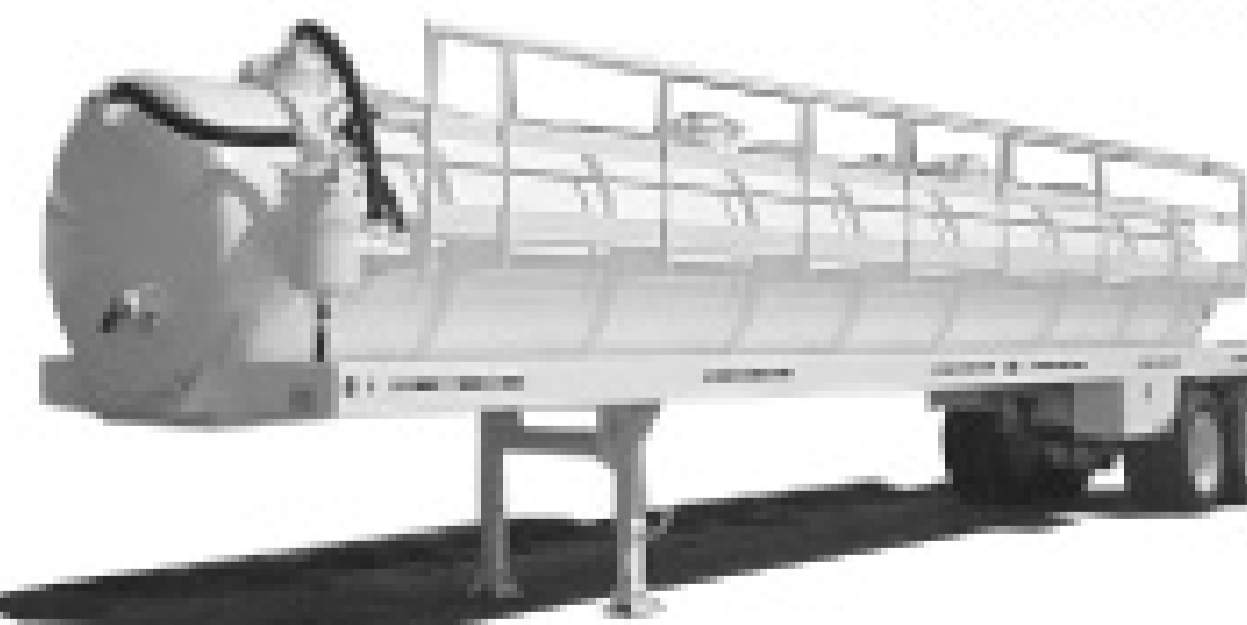

JEFF MULLICAN • HUBERT YOUNG • DENNIS ADAMS

Phone: 325-673-4642 • Fax: 325-673-4673

Web Site: www.truck-town.com • E-mail: truck@camalott.com

SAFE FRESH™

Deodorizers

Protection That Pays™



Scientifically Superior!



Online Ordering!



Unmatched Rewards!



Our exclusive ROI Program pays you back with FREE restrooms when you purchase SAFE-T-FRESH Deodorizers. (Special bonus for new customers)

Unique Triple Action Formula

Earn FREE RESTROOMS

Order A Custom Blend

Expert Advice and Service

Express Shipping



Place Your Order Online
www.safetfresh.com

 **Anytime - 24/7
Safe and Secure**

**For Assistance Call:
877-ROI-PAYS**

877-764-7297



Protection That Pays™

www.safetfresh.com

Protecting Systems and Customer Base

Pennsylvania contractor turns to a maintenance contract program to ensure proper care of systems it installs, as well as to lock in long-term profits

Since 2003, septic pumper Jeff Rachlin has offered customers maintenance agreements to cover routine system care and warranties to cover systems over time.

Rachlin operates OnSite Management Inc. in West Chester, Pa. He and two business partners, Bud Baroni and Derald Hay, design, install, pump, monitor, maintain and service all types of septic systems. The company with nine employees covers four counties in south-eastern Pennsylvania.

Pumper Interview

By Erik Gunn

OnSite Management has developed a complete set of maintenance contracts for its septic business. The agreements are targeted to new customers upon OnSite's installation of a system, but they're also made available to owners of an existing septic system once OnSite conducts an inspection and assessment.

OnSite's agreements are structured at three different levels based on what's covered. They're also priced based on whether the system is gravity-operated, a lift station, or a pressure-dosed system. Currently about 250 septic system owners have agreements — about 10 to 15 percent of OnSite's total customer base.

Rachlin explains how OnSite's Maintenance Agreements work to make life better both for the business and its customers.

Pumper: Why did you start offering maintenance contracts?

Rachlin: Once somebody's under contract, my thinking was I would take them out of the marketplace. If you have peace of mind and your system's being taken care of, you're not opening up the *Yellow Pages* looking for a contractor unless we screw something up.

Pumper: Describe your three levels of contracts.

Rachlin: The lowest one is the Bronze Plan. That basically takes care of all the routine maintenance required of the system,



I THINK THAT FEAR IS A BIGGER MOTIVATOR THAN WHETHER YOU CAN AFFORD IT OR NOT AFFORD A MAINTENANCE PLAN. CUSTOMERS REALIZE THIS NEEDS MAINTENANCE AND IT'S NOT A HOMEOWNER-FRIENDLY SITUATION. AS I SAID, NO ONE WANTS TO CLEAN THEIR OWN SEPTIC SYSTEM.

Jeff Rachlin

including pumping when necessary. The Silver Plan takes care of all maintenance required for the systems, plus it warrants the tanks and the pumps. The Gold Plan covers maintenance, warranties for the tanks and pumps, and also a warranty for the absorption area.

We recognize that a lot of people just want to pay for maintenance. But we offer a full warranty option because some people want that peace of mind.

When we install a system, the customer is automatically put on the Gold Plan for the first 12 months, with the idea that they would continue in some capacity after that once they know how the contract works. What I try to get them to understand is it's as close to flush and forget as you can get.

Pumper: Can a person with an existing septic system that you didn't install get a maintenance agreement too?

Rachlin: Anybody can get a maintenance plan. For a warranty we would first do a full inspection with a hydraulic load test. You have to look at it from an actuarial standpoint. If you've got someone on a ventilator, you don't want to give them life insurance. We try to manage our risk.

When someone calls us from the *Yellow Pages* and we pump their system, we leave them a brochure on how to take care of their system, some leak-detection dye tablets for their toilets, and information about the maintenance plan.

Pumper: If I'm a customer and I simply pay for three inspections a year as I go along, will it cost me more or less than if I buy the Bronze Plan, which covers those three inspections?

Rachlin: The Bronze Plan's definitely cheaper. It's something we can schedule.

Pumper: How does a maintenance visit help you keep tabs on a system's condition?

Rachlin: When we do a maintenance visit, our technician will fill out a one-page form. We leave a carbon copy that lets the owner know we were there. If there was a problem they'll know exactly what we know. A copy of that maintenance checklist comes back to the office and we'll go over them once a week. If there's an issue we're concerned about, we'll either write the customer a letter or call them. Usually, if our technician comes across a problem and notes it on the form he leaves behind, the customer will call us.

Pumper: How did you set prices for the various levels of plans?

Rachlin: First we asked ourselves, what do you need to do for routine maintenance? Then we figured out what it costs per visit. Then we factor in profit and overhead costs.

For the warranty portions of the plans, there's a vertical and horizontal analysis. The vertical analysis is: If I only have one under contract, over the lifetime of the system there's enough to cover the cost of replacing it.

The horizontal analysis is: If a septic system lasts "X" number of years, you would need "X" number of contracts to cover the cost of it if it failed today.

The ultimate goal is to not have any replacement at all. The better job we do, the more likely that is. We haven't had any catastrophic losses yet, but we've replaced some tanks.

We had to control for things that are not in our control. In a new car warranty, if you drive a car out of a showroom and you have an accident with it, the manufacturer isn't going to

stand behind it. Those are the types of things that are excluded. But for the most part our exclusions in terms and conditions don't limit us from saying that if your system fails, we'll be there.

Pumper: Do you have insurance against a catastrophic event related to this program?

Rachlin: No. We're self-insuring it. We have enough under contract to manage the numbers. In the beginning it was a little risky, but we were warranting our own work.

Pumper: How did you first get the idea for the program?

Rachlin: It really came to me when somebody tried to sell me a maintenance package for my heating system. I didn't buy it because I don't believe in buying extended warranties.

Pumper: But a septic system requires ongoing maintenance. Is that the difference?

Rachlin: Yes. When you have an HVAC system, you don't have a problem cleaning your own filter. But who wants to do that with your own septic system?

Pumper: How difficult was it to design contracts? Did you go through some trial and error?

Rachlin: It probably took about three months to develop. The trial and error was just to get information on a piece of paper.

One of the things that we didn't expect was that we found some deficiencies in our own work — tanks cracking and things of that nature. It's enlightened us to be better installers, higher quality installers.

Pumper: If you were starting from scratch now, would you do anything differently?

Rachlin: The changes occur as technology evolves. This plan doesn't cover drip systems or peat filters. We're actually doing that in some form now but it's just not covered under the same program.

When we set up the septic systems, we try to make it so they're easy to monitor and maintain. We want the main access on grade, we want monitoring ports in the absorption area.

Pumper: Why do customers buy these plans?

Rachlin: I think it's a more heightened awareness. Septic system management is becoming a buzzword. The municipalities and our state are starting to push management.

Where we are in southeastern Pennsylvania, if someone is selling their house, there is an inspection done on the septic system. If it's unsatisfactory, the buyer will go back to the seller and say, "I want a new system." Then the buyer sees the seller not only shell out that money but he sees what the seller went through and doesn't want that to happen to him. That's the teaching moment.

I think that fear is a bigger motivator than whether you can afford it or not afford a maintenance plan. Customers realize this needs maintenance and it's not a homeowner-friendly situation. As I said, no one wants to clean their own septic system.

Pumper: How do you respond to customers who just aren't interested?

Rachlin: I tell them, "Pay me now or pay me later." And I'll tell somebody myself that if we see things getting out of whack, it's easier to correct before it becomes a catastrophic overload.

CHECK IT OUT

For a look at the Onsite Management Inc. maintenance contract brochure, go to the Pumper® Web site at www.pumper.com/sampleforms.php and click on the appropriate link. ■

WE'VE GOT DRESSER ROOTS BLOWERS AND A LOT MORE

The Dresser Roots blowers are the finest truck mounted units available today. And, as a factory authorized sales and service center we're here to provide the best support for all your blower applications.

We're also here to help with your vacuum equipment repairs, rebuilding, and replacements that also includes our special blower exchange program.

Just give us a call.

DRESSER Roots

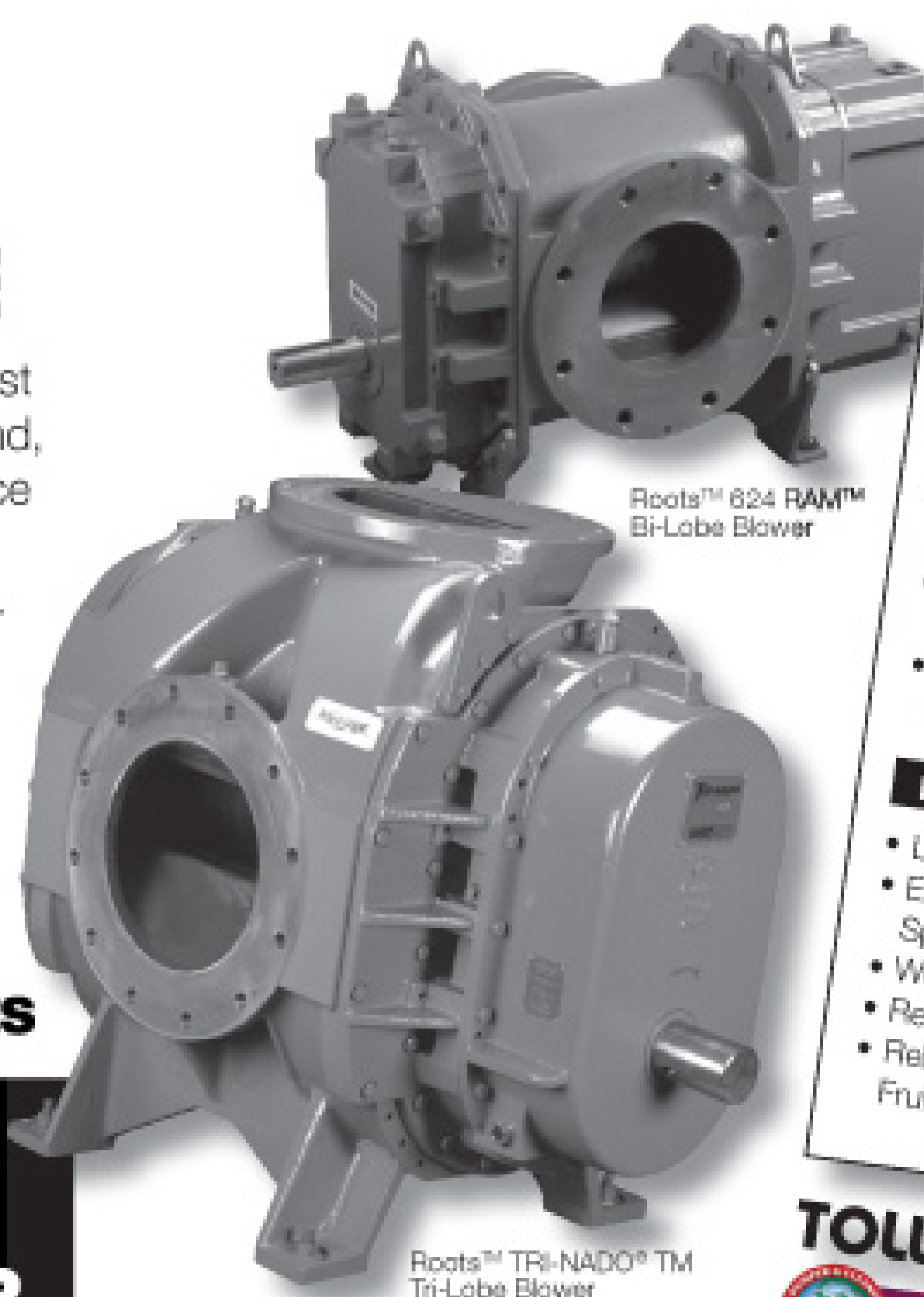

Roots™ 624 RAM™ Bi-Lobe Blower

Roots™ TRI-NADO™ Tri-Lobe Blower

VACUUM PUMPS, TRUCKS & ACCESSORIES

- Aquatech • Sewer trucks & equipment
- Conde • Toilet truck vacuum pumps
- Hi Vac • Industrial vacuum systems
- Metaltecnica • Valves & accessories
- O'Brien • Sewer cleaning jettors
- Presvac • Septic & sewer trucks
- Roots • Bi-lobe & tri-lobe vacuum blowers
- Stoddard • Intake filters & discharge silencers
- World-Tech • Sewer cleaning nozzles & valves

COMPLETE FABRICATION & MACHINE SHOP

- 24 Hour service
- Custom built blower and pump vacuum/pressure packages: electric, gas, or diesel
- Custom parts fabricated or reconditioned including bearings, shafts & sleeves

REBUILD SPECIALISTS

- Largest blower repair center in the Universe.
- Experts in rebuilding blowers: Roots, Sutorbit, Spencer, and Hibon
- We rebuild all vacuum pump makes and models
- Rehab sewer cleaning trucks and equipment
- Rebuild kits in stock for Schuit, Wittig, Moro, Jurop, Fruitland, and Challenger

TOLL FREE: (800) 359-PUMP
Booth 4088

Orlando, FL: 800-359-7867 • WWW.PATSPUMP.COM • Atlanta, GA: 800-851-7987

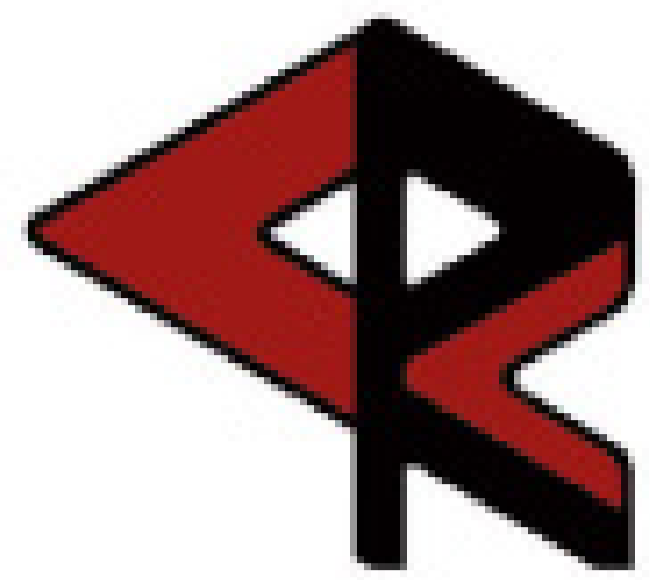

CAPITAL RUBBER CORP

Innovative Pumping Solutions - Since 1975



SPECIAL SHOW COUPON

RECEIVE \$25 OFF
ALL ORDERS OF \$250 DOLLARS OR MORE!

&

RECEIVE \$50 OFF
ALL ORDERS OF \$500 DOLLARS OR MORE!

VALID ALL MONTH LONG!

EXPIRES 3-31-08 NOT VALID FOR SHIPPING CHARGES

POWER BOOSTER



★ **SEE IT IN LOUISVILLE!**



800-258-3000

-HOSE. COUPLINGS. VALVES. MORE-

WWW.CAPITALRUBBERCORP.COM

THE PATENTED TECHNOLOGY
PROVEN TO INCREASE LIFT
ON A VACUUM TRUCK

POWER BOOSTER

- **TESTED TO 100 FT VERTICAL**
- **BREAKS UP HEAVY MATERIAL**
- **SPEEDS UP PUMPING TIME**
- **REDUCES PUMP WEAR**

★ **SEE IT IN LOUISVILLE!**

EXCLUSIVELY AT BOOTH 3093

(800) 258-3000



YOUR PUMP IS CLEAR FOR TAKEOFF

VERTICAL LIFT: ✓

WWW.CAPITALRUBBERCORP.COM

MEET THE INSPIRATION FOR OUR NEWEST PORTABLE RESTROOM

**MOMS LOVE OUR
NEW FAMILY ROOM.
SEE IT AT THE
PUMPER SHOW
BOOTH 1140**



**FLEXIBLE FINANCING
AVAILABLE NOW**
Lower payments... longer terms...
less interest... deferred payments...
What do you need?

FREE MAGIC SHOW

Magician Gregg Lambert will be performing daily
at the PolyPortables booth #1140.

Our sincere thanks to good customers who stimulated our thoughts about the problems of parents with infants at events. That's a stressful situation to say the least.

We needed to customize one of our units to fit their needs. (No problem. We often do custom colors and modified designs for our customers.) Our new Family Room unit is the result. It turned out so well, we decided to offer it to everyone.

The new Family Room enables you to offer something new to event promoters this year. Moms love it and it's a great add-on sale for you.



BOOTH 1140



POLYPORTABLES

Listening. Learning. Delivering. Since 1972

99 Crafton Drive, Dahlonega, GA 30533 USA • Phone (800) 241-7951 or (706) 864-3776 • Fax (706) 864-8111 • www.polyportables.com

Only PolyPortables offers high-performance Green Way Products

TOILET DEODORIZERS • TOILET CLEANERS • AIR FRESHENERS • INSECT REPELLANT

All Green Way deodorizers, cleaners and air fresheners are earth-friendly, people-friendly products. They are developed and manufactured in our facilities in Dahlonega, Georgia by Green Way Products, a PolyPortables sister company.



Green Way Products
solutions for life



The Leader in Trailers, Parts & Service

1139 N. 27th Ave.
Phoenix, AZ 85009

888-244-3043
602-319-5656

thofeldt@beallcorp.com

Largest Tank Manufacturer in the
Western United States

Over 100 Years Experience in Industry
Leading Quality & Innovation

Truck Chassis Programs Available

Dealers Wanted!

STANDARD VACUUM TANKS

TOILET TANKS

1250 GAL 2 CMPT
1500 GAL 2 CMPT
2000 GAL 2 CMPT



VACUUM TANKS

2500 GAL 1 CMPT
2800 GAL 1 CMPT
3600 GAL 1 CMPT



**ARMSTRONG
EQUIPMENT
INC.**

MODEL 806B SEELEVEL ANNIHILATOR™

MODEL 806B SeeLevel ANNIHILATOR™

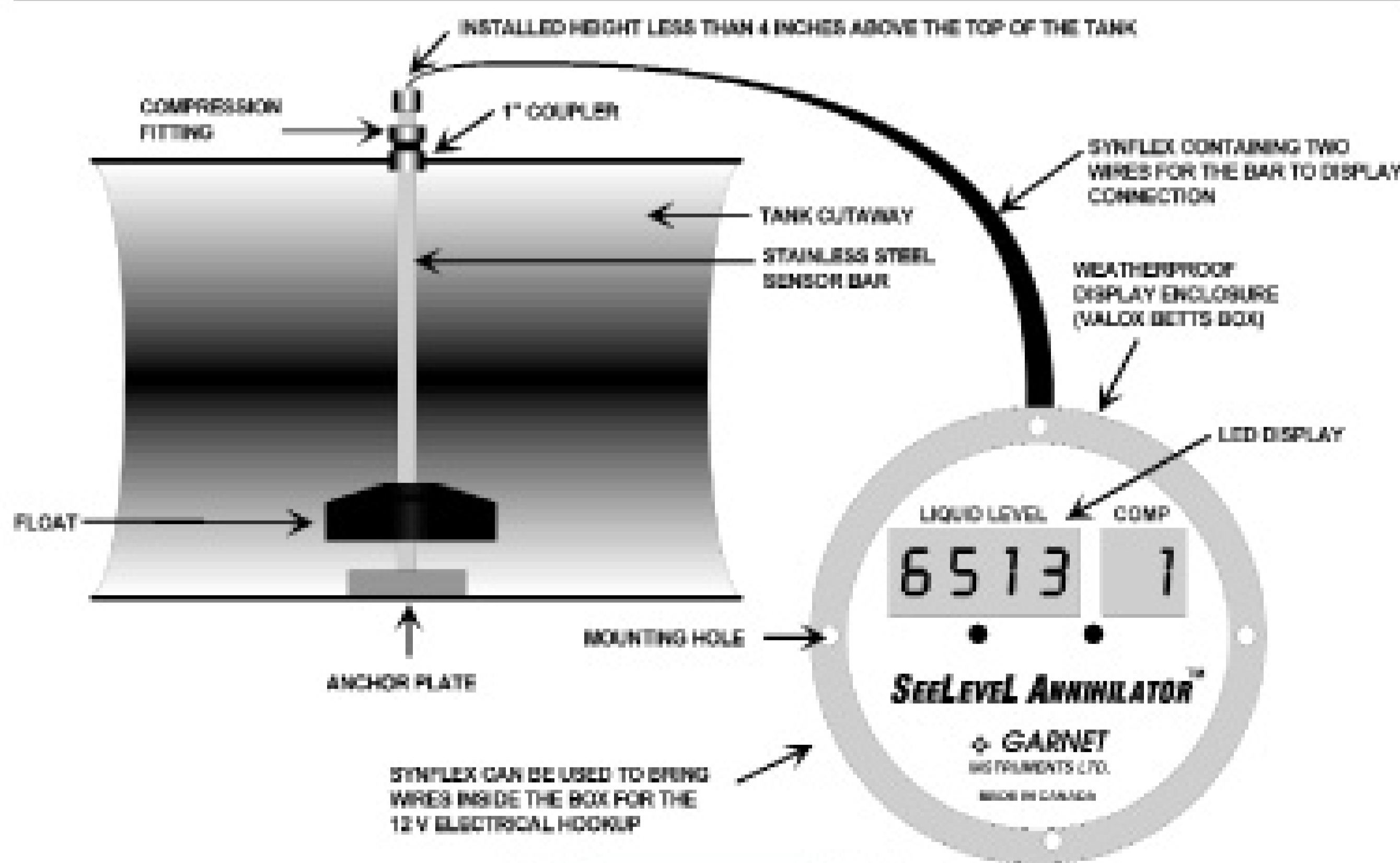

• **Accurate Readings to 1/4"**
Even with vacuum or pressure on the tank. No need to shut down pumping to check tank level.

• **Work Safely**
Can be programmed to control warning devices.

• **Plan Your Route**
Tracking customers tank size allows for improved route planning.

• **Protect Your Pump, Avoid Spills**
See the level of your tank throughout the pumping process.

• **Maximize Efficiency**
Avoid unnecessary trips. Can I get one more load, or should I head for the dump? The guessing game is over.

• **Communicate With Your Customers**
Pumping 1500 gallons from a 1000 gallon tank indicates problems

These are all good reasons to equip your next truck with a SeeLevel model 806B liquid level gauge system. The 806B can be programmed to read liquid levels in up to three compartments with only one display. It can also accept up to three alarm settings for triggering a warning light, sounding an audible alarm, or closing a loading valve; all while the tank is loading.



11200 Greenstone Ave. | Santa Fe Springs, CA 90670
800.699.7557 or 562.944.0404 | fax: 562.944.3636
e-mail: sales@vacpump.com | web: www.vacpump.com

To find out if the 806B can benefit your business, contact your tank manufacturer or call us
Toll Free at 1-800-699-7557



VAC-CON

MORE POWER TO YOU

PRE-OWNED EQUIPMENT



Booth 1202



2002 VAC-CON V390LHA/1000

- 2002 STERLING L7501
- 275 HP / Allison MD3060
- 60 @ 3000 / CUMMINS 130 HP
- Mileage: 35,500

< SOLD >



1997 VAC-CON V312THAE/1300

- Ford LNT8000 / 275HP / MD3060
- 50 @ 3000 Water Pump
- Mileage: 66,703 (kilometers)

RECONDITIONED **\$140,000**



2004 VAC-CON V390LHAD

- 2004 International 7400
- IH 275 HP / Allison MD3060
- 50 @ 3000 / DEUTZ 138 HP
- Mileage: 11,000

\$195,000



1998 VAC-CON VPD3612LHA

- 1999 IH 2554
- 275 HP / Allison MD3060
- 80 GPM @ 2000 PSI
- Mileage: 116,000

RECONDITIONED **\$138,000**



2000 VAC-CON V312LHA

- 2001 IH 2554
- IH 275 HP / Allison MD3060
- 50 @ 3000 / Cummins 110 HP
- Mileage: 122,800

RECONDITIONED **\$135,000**



1998 VAC-CON VPD3690SHA

- 1998 FORD L8501
- CAT 250 HP / 7-SPEED
- 70 @ 2000 / John Deere 4045T
- Mileage: 115,000

< SOLD >



2001 VAC-CON V311LHA/1000

- 2002 Sterling LT7501
- CAT 275 HP / Allison MD3060
- 60 @ 2000 / Cummins 110 HP
- Mileage: 40,000

RECONDITIONED **\$155,000**



1997 VAC-CON V316THA/1300

- 1996 FORD LTS9000
- 300 HP CAT / 10 SPEED
- 80 @ 2000 / John Deere 4045T
- Mileage: 78,500

RECONDITIONED **\$140,000**



www.vac-con.com



Ultimate Lease Hotline:
888-817.1757

969 Hall Park Drive • Green Cove Springs, FL 32043 U.S.A.
Tel: 904-284-4200 • Fax: 904-284-3305
www.vac-con.com • vns@vac-con.com



PRECISION TANK & EQUIPMENT CO.

www.precisiontank.com | 1.800.258.4197

CENTRAL ILLINOIS Manufacturer Celebrating 40 years of steel and stainless steel tank equipment innovations. Tank sizes from 100 to 5000 gallons in stainless steel or steel.

Manufacturing plants in Virginia and Athens Illinois bringing quick completion of your pumper truck!
40 years of excellence! PRECISION TANK & EQUIPMENT CO.

*Standard models or
custom built units*

*Single or multiple
compartments*



Thank you to Darr's Cleaning for the purchase of a new all stainless steel 4200 two compartment tank with DC-10 washdown pump and Masport 400 WV vacuum system

1.800.258.4197

Booth 4127

Comforts of Home Services, Inc.

LUXURY TRAILER SALES

- Lowest Interior Floor Height In the Industry
- ADA wheelchair accessible units.
- Unlimited Floor Plans from 8' to 53' Trailers
- Rigid Steel Shell Construction from top to bottom to resist rot and warping.
- Specializing in Customizing trailers to fit your needs.
- 24/7 Tech Support for the best customer service available.
- Free Nation Wide Lead Program for our customers.
- Easy Fold-Up Steps & Door Handles
- Large Capacity Waste Tanks
- High Privacy Partitions are Standard for Added Comfort
- Rigid Platform, our smallest wide body trailers start out with Dual 10' ASTM I-Beams.

Starting at \$13,400 with A/C, Heat, HD Steps and a Large 300 Gallon Waste Tank

See our website for more layouts and prices

8' starting at \$13,400
w/A/C & Heat - 300 gal waste

12' starting at \$21,300
w/A/C & Heat - 450 gal waste
Includes Showers

20' starting at \$29,900
w/A/C & Heat - 600 gal waste

24' ADA starting at \$35,600
w/A/C & Heat - 750 gal waste

INFO@COHSI.COM • 877.382.2935 • WWW.COHSI.COM

Wolf Creek Co.

Original Bauer

Bauer Fittings

Portable Piping

Polybarb™ Pipe & Tails

Polybarb™ HDPE pipes and fusible tails available in 4" to 12" diameters up to 40' in length.

Available in weldable, hose insert, and flanged connections. Fittings available from 2" to 12".

Booth 29

Bauer Pipe

Galvanized piping available in 2" to 12"

Industrial Vac Tubes

We can fabricate aluminum vacuum evacuation or suction tubes per your specifications. Using the Bauer Coupler or Anfor Coupler.

800.488.7305 • www.wolfcreekcompany.com



Our **VALUE** goes deeper than you realize.

When it comes to portable sanitation solutions, WALEX delivers much more than blue deodorizers and accessories. We're giving you **innovative research & development** that has set all the current standards for excellence. You're getting **proprietary breakthroughs** that our competitors can only emulate. When you choose WALEX, you're not only getting **the best on the market today** — *you're also supporting your industry's future.*



Booth 2209

*For more information, contact us at 910.371.2242, toll-free 800.338.3155
or visit our website at www.walex.com.*

OLD Name, NEW Ideas



Rob Labelle, of Jack Spack Septic Tank Service, Inc., speaks with a customer after locating and pumping a septic tank. At right, Labelle probes for a second tank at the same location. (Photos by Randall James)



Fresh marketing tools and inventive disposal solutions build on a solid 60-year foundation for Michigan pumping firm

By Richard Ryman

Jack Spack Septic Tank Service Inc. has been in business for nearly 60 years. To continue for another 60 will take good planning and the solving of a vexing disposal problem.

Duane and Victoria Relitz are on it. They have developed a dynamic business plan, employed some simple-but-effective marketing tools and are planning short- and long-term solutions to disposing of septic waste.

"Our business plan is a living document. We are constantly changing it based on us becoming educated," says Duane Relitz, general manager of the company, which is owned by Victoria. She acquired the company from her brother, Jack Spack Jr., in late 2006.

Relitz says that unlike his father-in-law and brother-in-law, he doesn't have the instinctive feel for the business they built up over a lifetime of work.

"Those guys, they can feel it. My father-in-law didn't have a business plan, but he knew what his costs were," Relitz says. "I'm new to this industry. I have a tool to accomplish,

Profile Jack Spack Septic Tank Service Inc.

Ypsilanti, Mich.

Owner: Victoria (Spack) Relitz
 Founded: 1948
 Employees: 6 full-time, 2 part-time
 Services: Septic-system pumping and inspection, well inspection
 Service area: Washtenaw County, Mich.

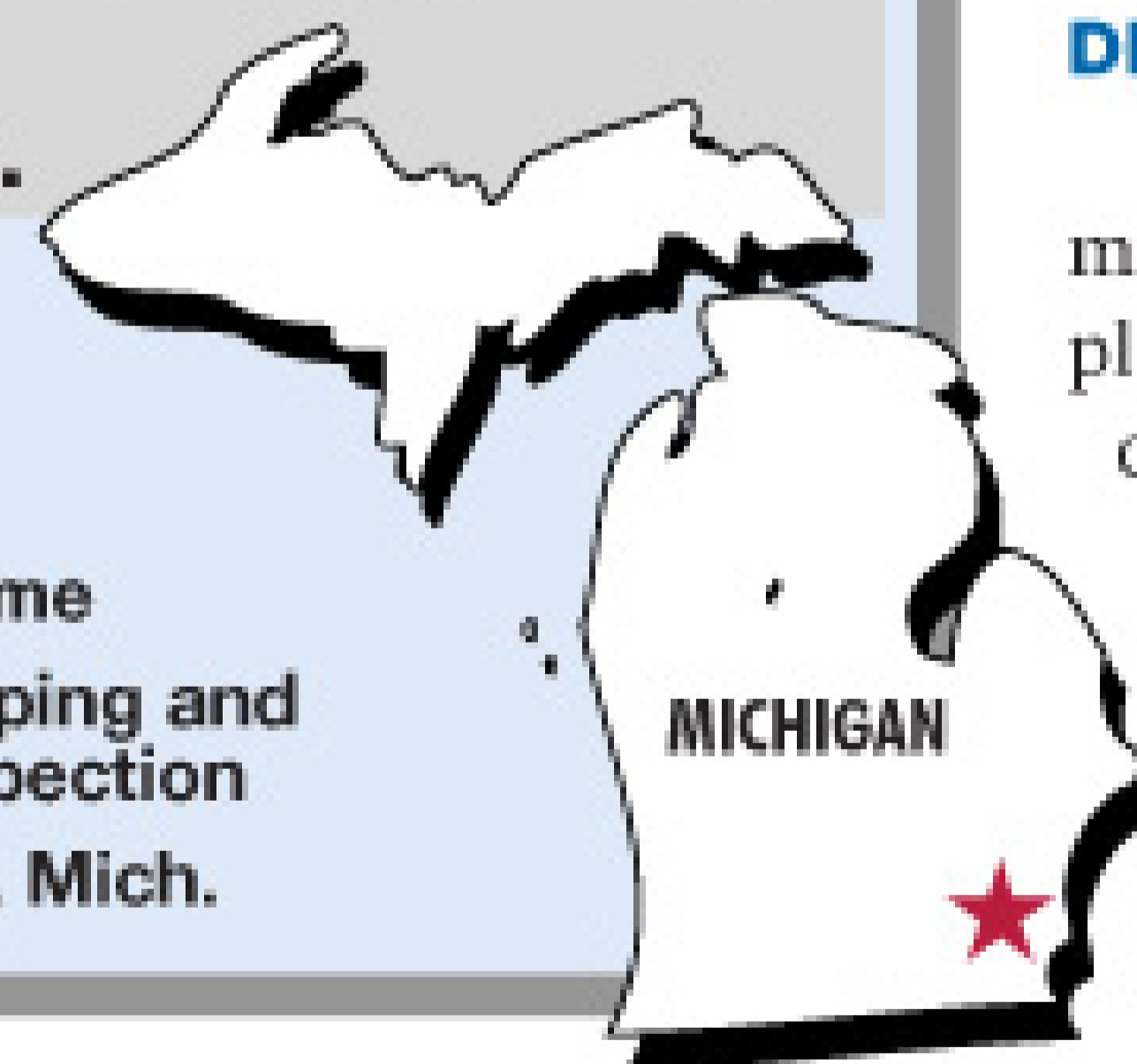

DISPOSAL DILEMMA

Relitz says the 38-mile trip to a disposal plant in Detroit will cut disposal costs to about 25 percent of sales. He estimates a tractor-trailer rig can make two or three trips a day. They are considering a truck

hopefully, the same thing."

So far, Relitz determined they needed more income in the winter and that local disposal was costing as much as 40 percent of sales.

"Right now, our only choice is to transfer waste to a cheaper facility than what we have locally. We are buying a tanker to accomplish this," he says.

with a 12,000-gallon aluminum tank.

In addition to lowering disposal costs, Relitz says the tanker will allow more flexible planning and pricing.

"When we have a tanker, I can go to outlying parts of the county and have five tanks lined up. I can give them a discounted price because I can have the tanker up there," he says.



Above, members of the Jack Spack Septic team (from left) include Holly Baker, Kevin Stuebben, Rodney Schroeder, Rob Labelle, Jack Spack Jr., Vicky Relitz, Duane Relitz and Brad Farmer. At right, Labelle unloads a truckload of sewage at local sanitation facility.

Also, Relitz says, the receiving facility closes at 3 p.m. The tanker could sit full overnight and be delivered first thing in the morning, which means they can work later in the day.

"It's doable, particularly when people believe the postcards I send them and they get their systems pumped on a preventative basis instead of an emergency basis," he says.

The second phase of their business plan envisions a dewatering facility.

"That should allow us to redirect our focus and only be transporting water to a much closer location than Detroit," Relitz says. "Hopefully, we'll get a much better price (than now). They don't have to do much with it."



The Jack Spack Septic management team includes (from left) Jack Spack Jr., Vicky Relitz and Duane Relitz. The company was founded in 1948 by Jack Spack.

Michigan law prohibits land application of any waste pumped within 15 radial miles of a receiving facility. In 2010, the range increases to 25 miles. Relitz says about half the state can land-apply, but in his county, it wouldn't be worth the effort of getting a farm approved.

As to adding revenue, the couple considered then rejected the idea of going into the portable restroom business.

"It seemed like a good fit, but we couldn't squeeze the money out of it. It didn't do anything for the off-season," Relitz says. "We would rather take the resources and satisfy our customers and expand our customer base in the septic industry."

They are adding plumbing repair to their services, instead. They looked at franchise operations, but decided in the end that the Jack Spack name would be marketable in the plumbing repair area as well.

TURNING 60

Jack Spack Septic was founded in April 1948, when

"OUR PEOPLE WORK VERY HARD. EMPLOYEES GET MONTHLY BONUSES. I REWARD THEM. I NEED THEM TO BE HERE AND I NEED THEM TO BE COMFORTABLE ... HOPEFULLY, WITHIN TWO YEARS, WE CAN START IRAS OR A RETIREMENT FUND FOR THESE BOYS."

Duane Relitz



Jack Spack bought a used truck and began hauling waste part time while working at the Ypsilanti State Hospital. The business grew steadily, and in 1953 Spack began running the septic business full time. The work included maintenance and installation as well as pumping.

Maintenance and installation services were discontinued before the Relitzes took over, but Relitz says they may ease back into it as a result of the plumbing work, "just to utilize the equipment we have."

Spack died in 1996, the business passing to his son, Jack Spack Jr., who enjoys the work, but not so much running the business. He sold the company to his sister, but remains a key employee.

"We truly need him in the business," Duane Relitz says. "He's a certified well and septic inspector and does all of our technical-service calls."

Relitz, who is 56, at one time owned a \$15

million manufacturing company with 125 employees. The company, which made diesel truck parts, lost too much of its business to China and India, so Relitz closed it about three years ago and enjoyed a two-year hiatus.

"When this opportunity came up, it was just a matter of negotiating the details," Relitz says. "I worked for Jack Sr. in 1972. Vicky worked for him in the office in 1976. We had talked for many years about marketing and the database here."

RELIABLE FLEET

Relitz says much of his experience running the manufacturing plant applies in the septic industry, especially marketing and bill collection.

"We bill a great portion of our customers. Sometimes you have to call them; sometimes you get burned," he says.

Their fleet includes a 2003 International 7400, 1999 International 4900, 1988 International F1954 and 2003 Ford F-150 pickup truck. All the Internationals have 3,000-gallon steel tanks with Moro USA Inc. pumps. The tanks were custom-designed and fabricated to Spack specifications by Mel Patton, a local welder and friend of the family.

The two newer pumpers are on the road daily; the oldest is the backup. The business plan calls for buying a new pumper each of the next three years. Relitz says they'll have large tanks, likely aluminum or stainless steel.

"They'll definitely be bigger than the 3,000 gallons we have now, but we can't get too big," he says, to prevent damage to customers' driveways and residential streets.

The company has two full-time and two part-time drivers who pump about 3 million gallons a year.

"Our people work very hard. Employees get monthly bonuses. I reward them. I need them to be here and I need them to be comfortable," Relitz says.

Employees also receive medical and dental coverage paid for by the company, Relitz says. And uniforms are provided. "Hopefully, within two years, we can start IRAs or a retirement fund for these boys."

New-employee training doesn't happen often because there is so little turnover, Relitz says. A new employee would need a commercial driver's license and several months of rid-

ing with experienced employees before being turned loose.

RISING SALES

The Relitzes live at the site, so keeping up is not difficult. "I'm out here from 3 a.m. to 6 a.m. I have trucks running and washed and maintained as needed when the guys get here," Relitz says. He's not above being in the field, but rarely gets the opportunity because he's usually working the telephone.

"Over the past few months we've seen a 35 percent sales



Jack Spack technician Kevin Stuebben uncovers and pumps out a customer's septic tank.

increase," he says.

Relitz says there are about 350,000 residents in the county, with five or six municipal areas that have their own sewer systems.

"In the rural areas, there are a lot of subdivisions, and they are upper-end. There is a considerable amount of money in this economy," he says.

The company operates in a 35-miles radius, which allows it to dip into surrounding counties.

"We don't want to get real big," Relitz says. "We want to keep it a family business, family controlled and family-sized with a family orientation." ■

Boost marketing efforts with postcards, effective Web site

Upon taking over Jack Spack Septic Tank Service Inc., Duane and Victoria Relitz realized that informed and educated customers were the quickest route to stable and increased sales.

"We recognized that the 15,000 customers in our database needed to be notified of when their septic tanks were due to be pumped," Relitz says. "The response was overwhelming."

The result was six consecutive months of record sales.

They began by sending postcards to customers and making available education packets that include plenty of good information laced with humor.

"We have an old-time story about starting the bacteria by throwing a dead cat in there, which is ludicrous by today's standards," he says. "The people really like it. It is an entertaining piece of information. We have a lot of good information from (reputable) sources."

They are developing a Web site with a similar approach.

"What we are working on is an animated version of a septic system and how it works," he says.

Because his customer-base skews older, Relitz says the Web site will probably not be as effective a marketing tool in the short run as the postcards. Younger customers, of course, will be more comfortable with the Web.

Postcard information isn't limited to cleaning schedules. The notices also remind customers that filters need to be cleaned. A lot of the new customers are city folks dealing with septic systems for the first time, he says.

"Any communication we can make with the customer ... the cost of postcards is pretty cheap," Relitz says. "People really appreciate it, because they don't think about it."

Relitz says three other pumpers work his market, but Jack Spack Septic is the largest. He says the competition hasn't forced him into a price war.

"Like one of the people at a seminar (at the Pumper & Cleaner Environmental Expo) said, 'You better price at what your costs are, not at what your competitor's costs are,'" Relitz says.

The Spack name carries weight. Relitz says the company provides service to the children and grandchildren of Jack Sr.'s original customers.

The Jack Spack name is a wonderful marketing tool, Relitz says, but it carries with it a lot of responsibility.

"Because so many of our customers dealt with Jack Sr., we have to maintain that level of integrity, and we do," he says. "So many times, we get calls that say come and do it. Send me a bill or here's my credit card number. And that's because they know we will be honest with them."

MORE INFO:

Moro USA East Inc.
800/383-6304
www.morousaeast.com

Spare Parts Kit



Our spare parts kit comes complete with everything you'll need to repair your Hampel restrooms —

Nothing.

The most durable and affordable restrooms available.

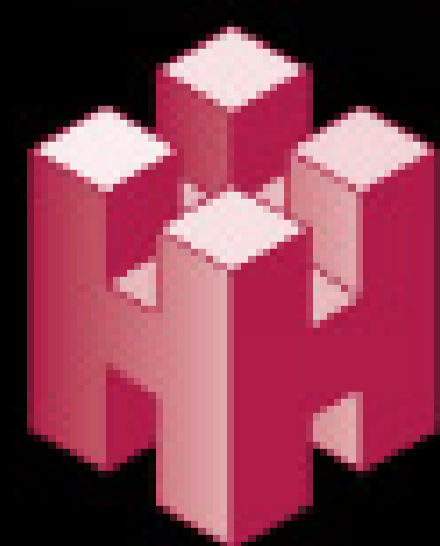

Hampel



Engineered for strength, durability and value.

www.hampelcorp.com • 800-549-1558



Booth 4171

OVERLAND TANK, INC.



200BBL DOUBLE CONICAL CRUDE OIL TRAILERS

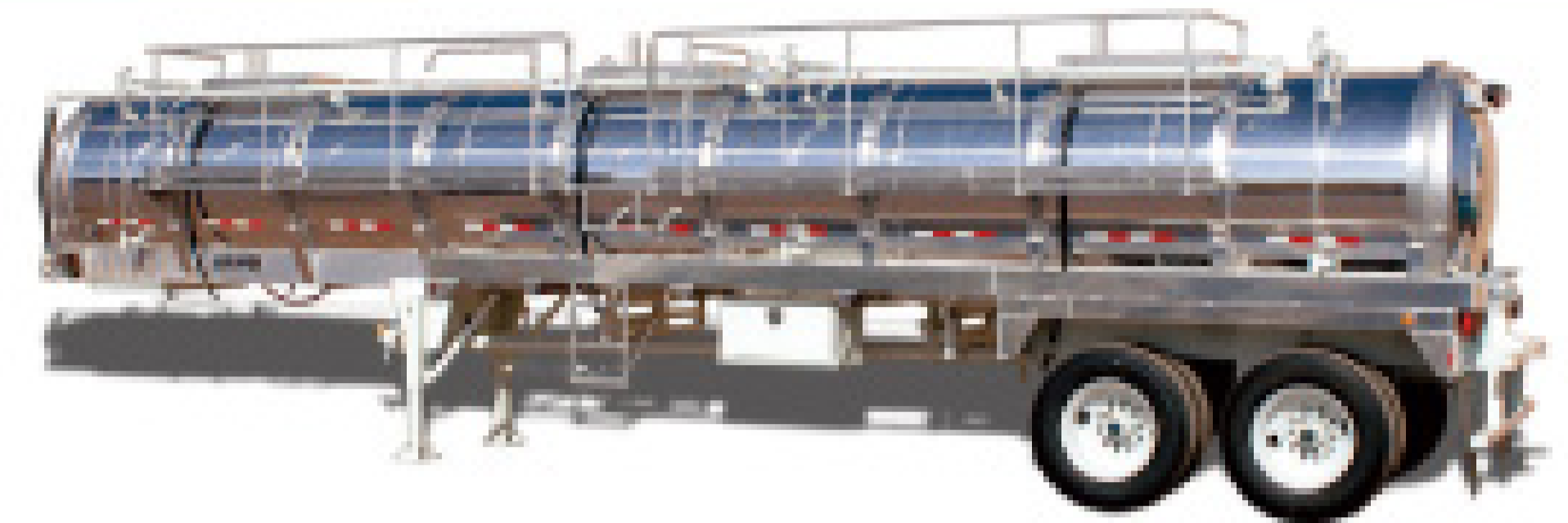

ALUMINUM VACUUM TRAILERS
ALUMINUM TRANSPORT TRAILERS



TWIN DOT 407/412 ACID TANKS

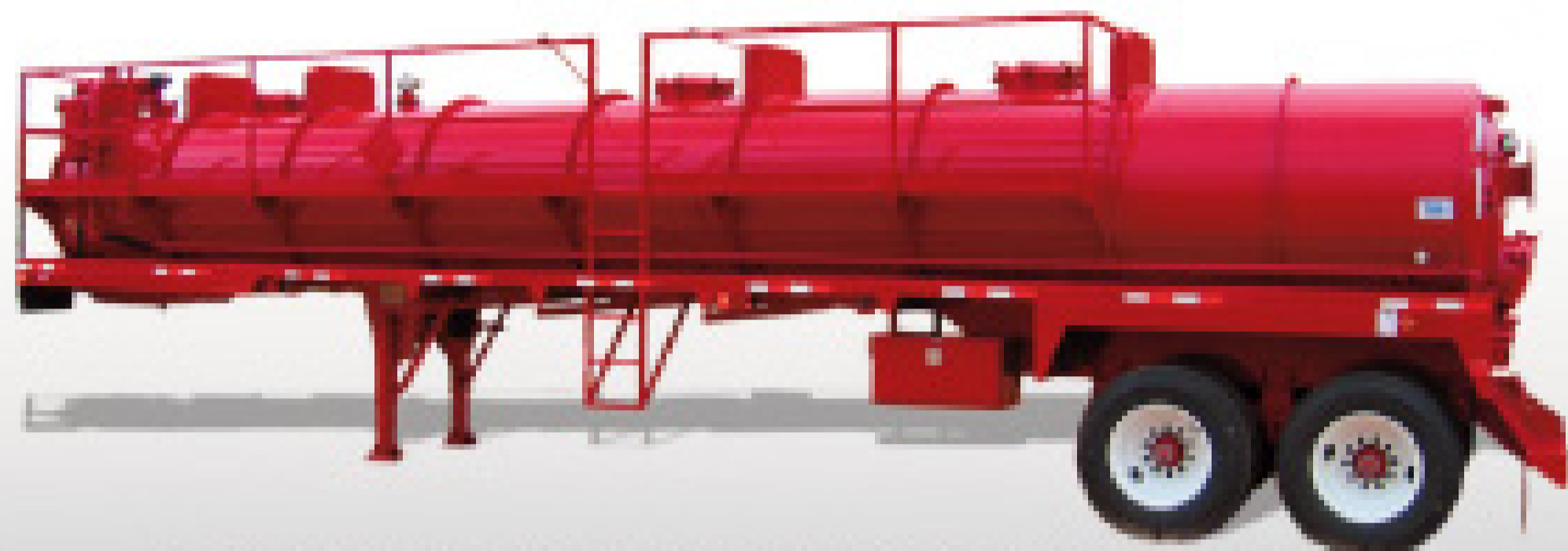

ASME CODE VACUUM TRAILERS



STEEL TRANSPORT/KILL TRAILERS



DOT 407/412 ACID TRAILERS



SEE US IN LOUISVILLE
RUSH SALES BOOTH

7222

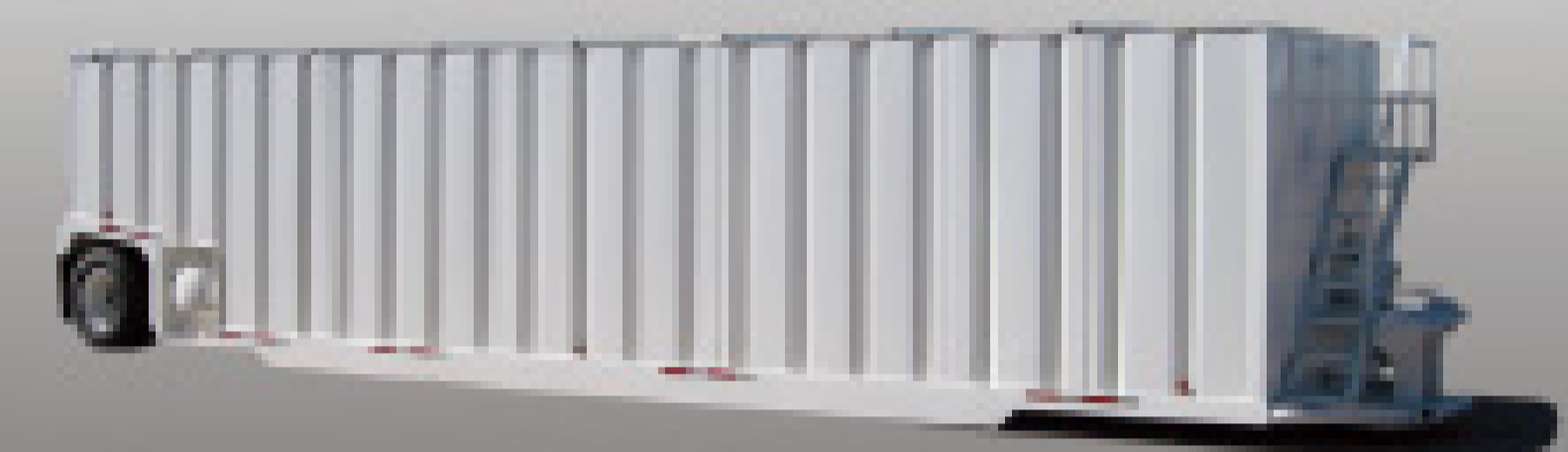

500 BBL PORTABLE FRAC TANK

4725 FM 18 ABILENE, TEXAS 79602 WWW.OVERLANDTANK.COM TOLL FREE: 866.635.7132

Need to hydro-excavate or vac-excavate
where your boom won't reach?



WE HAVE THE SOLUTION...
MOBILE VAC BOOM!

Add safety AND save your employee's back:
"Don't break your back when you vac"
at a fraction of the cost of a workers comp claim!

Available for mini-excavators, excavators
or backhoes



Ace Supply
(814) 899-3644 www.mobilevacboom.com

Lenzyme

Quality Sells ~ Sell the Best

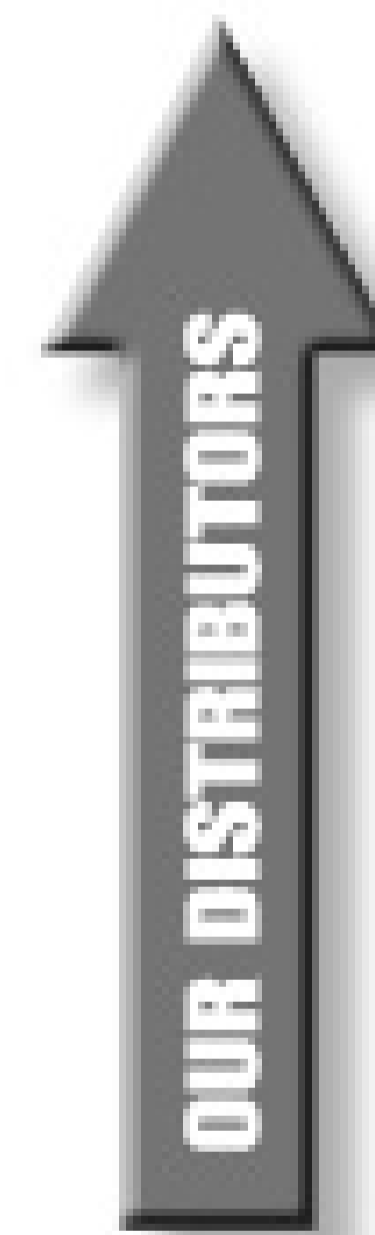

Discover the
SECRET



to MORE
PUMPOUTS
even in this
Down Market

Products to BEAT all Competitors Pricing!



Call Today for Your **FREE** Sample



1-800-223-3083

920-436-8266 • Lenzyme, Inc.

The

5

Enzyme - Bacteria
Grease and Waste Digestant



Join hundreds of pumpers who have come to rely on our products!

PRO-PUMP®

Visit Booth #4094 at Pumper Expo!

The Finest Name in Biological Products for Septic Systems, Anaerobic and Aerobic Systems, Absorption System Recovery, Odor Elimination and More...

Get More Income with Every Tank Pumped!



SEPTIC SAVER

Introducing New PRO-PUMP®/SEPTIC SAVER!

PRO-PUMP®/SEPTIC SAVER is a combo pack of our two best selling septic treatments: PRO-PUMP®/HC & PRO-PUMP®/SP packets, bundle packed as a monthly (12) treatment program. Complete with instructions and two leak detection tablets, this great new item is ideal for increasing your sales on every service call as well as assuring proper septic system care.

The PRO-PUMP® biological series is designed to meet a wide range of on-site wastewater applications with unmatched performance!

- Septic System Treatment
- Absorption System Recovery
- Aerobic System Treatment
- Drain & Grease Traps
- Solids Reduction
- Odor Control
- Satisfied Customers!

The Best Microbial Technology Available Today!



Over the years our customers have come to value the ability of PRO-PUMP®/HC to resolve tough system problems and even improve absorption flow in failed systems.

PRO-PUMP® PRODUCTS ARE DISTRIBUTED EXCLUSIVELY THROUGH SEPTIC PROFESSIONALS!

Sales Materials & Technical Support at No Charge!

We provide technical support, combined with informative sales and marketing materials, and we don't sell direct to the consumer! All web-based inquiries are forwarded on to you!



Solving Problems, Naturally!
Ecological Laboratories INC.

CORPORATE OFFICES: 13 Hendrickson Ave., Lynbrook, NY 11563
TOLL FREE: 1-800-326-7867 • FAX: 516-823-3440 • EMAIL: info@propump.com

Visit our web site at: www.propump.com



Built Better to Perform Better



Booth 6051

NEW! Dual Pedestal Reel

Patent Pending

Shown: DP7850 DLP

Very strong, yet compact vibration-resistant new design

Better by Design:

- ✓ Engineered for your most demanding vehicle-mounted applications
- ✓ Innovative new heavy duty design
- ✓ Very compact...fits in tight spaces
- ✓ More resistant to vibration
- ✓ Durable, powder-coated finish ensures maximum resistance to corrosion
- ✓ Innovative latching mechanism prevents hose latch-out
- ✓ Ask about Reelcraft's full range of hose reel products



NEW!

Patent Pending

Series DP7000

Military Tested

Rely on Reelcraft's Series DP7000 for greater resistance to vibration. Series DP7000 meets or exceeds military Vibration for Truck Transport testing: MIL-STD-810F, 500,000 mile equivalent.

Reelcraft Industries is
ISO 9001:2000
Certified since 1996

IEN Winner 2006
BEST BRANDS
Hose, cord
and cable reels

800-444-3134

reelcraft.com/pumper

REELCRAFT

Wind Things Up With Reelcraft

Flexible and Affordable Financing Options



Financing for New and Used Equipment:

Trucks	Tanks
Trailers	Toilets
Cameras	Jetters

also Computer Hardware & Software



Booth 3127



7 Church Road Hatfield, PA 19440
Phone: 800.422.1844 Fax: 888.883.9380
Visit our website: www.libertyfg.com

COMMERCIAL EQUIPMENT FINANCING
CALL 800-422-1844

ABERNETHY

WELDING & REPAIR INC.

Vale, North Carolina 28168

Call Bill Abernethy at **1.800.545.0324**

Fax: 828.324.2401 • E-mail: abernethyinc@charterinternet.com

authorized distributor for:

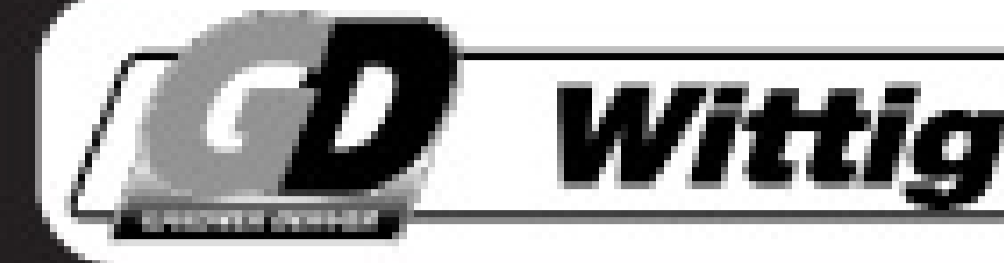

www.abernethywelding.com

**2008's
Are Here!**

- International
- Ford • GM

2008 PETERBILT

2500 gal. tank, 2 with 6-spd.

2007 KENWORTH T300

2500 gal. tank, 6-spd., 260 hp

(2) 2008 INTERNATIONAL 4400

2500 gal. tank,
(1) 6-spd. transmission &
(1) Auto transmission

NEW PORTABLE TOILET UNITS:

(2) 2008 INTERNATIONAL 4300s

1500 gal. portable toilet service units,
Auto transmission

2008 5500 CHEVROLET

1000 gal. 700 waste / 300 fresh,
2 Wheel Drive &
4 Wheel Drive available

**Only
12 Pre-
emission
Trucks
Left**

WE WILL CUSTOM BUILD YOUR TANK UP TO 5000 GALLONS!
600-1500 Gallon Portable Toilet Trucks: Our Truck or Yours

SEVERAL GOOD, OLDER TRUCKS TO CHOOSE FROM:

- (2) 1995 Internationals
2500 gal. tank
- 1997 Volvo
4000 gal. tank
- 1998 Volvo
4000 gal. tank

PORTABLE TOILET UNITS:

- 2000 Isuzu
800 gal.
- 1999 Freightliner
1500 gal.
- 1999 Sterling
1500 gal.
- 1991 4700 International
1400 gal. tank

**MANY OTHER
UNITS IN STOCK!**

**CALL
FOR UPDATE**



2008 International 4400E Series,
260 hp diesel DT 466 engine, 6-spd. trans. and world class auto, air
brakes, 33,000 GVW, air conditioned, 2500 gal. tank, Masport HXL400
pump. **IMMEDIATE DELIVERY!**
Also, 2500 and 3500 gal. tanks **READY FOR
IMMEDIATE DELIVERY.**



2008 International 4300,
220 hp DT466, Allison auto. trans., air brakes, 25,999 GVW, air
conditioned, total tank capacity: 1100 waste/400 fresh, Masport
HXL75V pump. **IMMEDIATE DELIVERY!** Also, 1500 gal. tanks
READY FOR IMMEDIATE DELIVERY.

Check with us on financing for the purchase of a new truck!

COMPLETE PARTS AND IN-HOUSE SERVICE FOR:

AIC Vanes • Moro • Battioni • Jurop • Masport • Fruitland • NVE • Powerflo • Plus many other brands

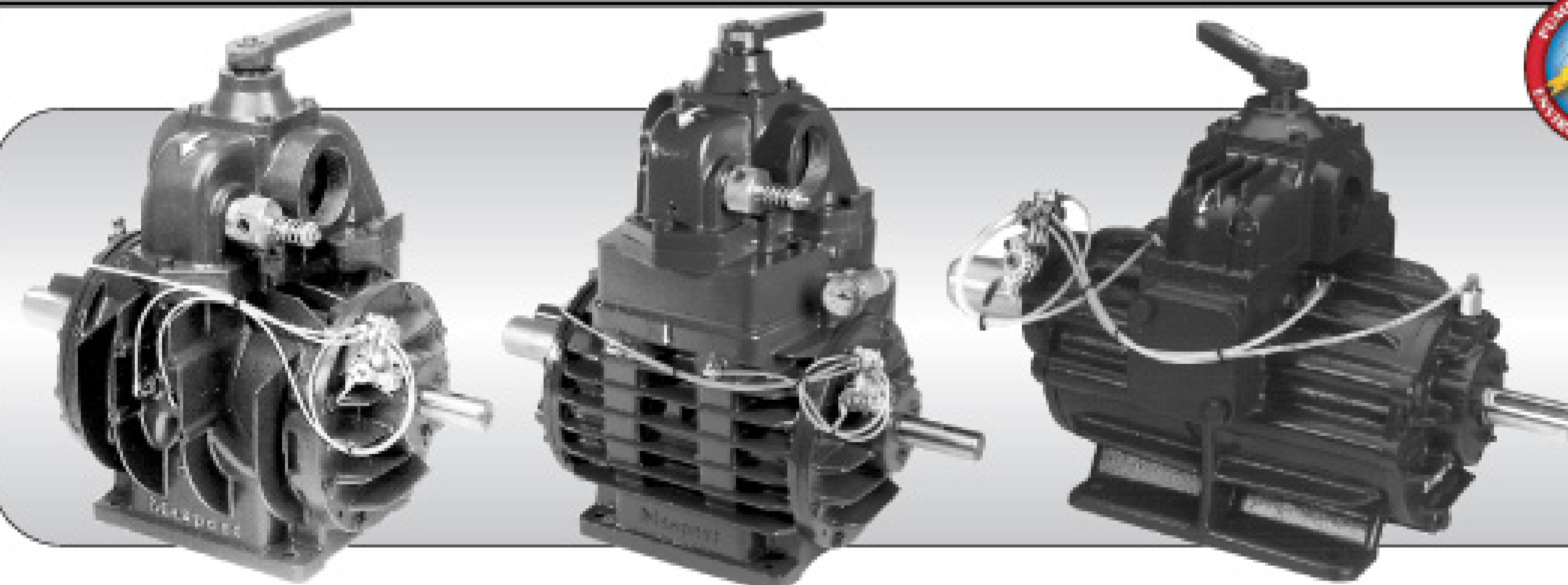

Booth 7057

**Complete Line of
Masport Pumps
Available**

Immediate Delivery

OVERNIGHT DELIVERY ON PARTS • SAME DAY SHIPMENT ON PUMPS

WE SPECIALIZE IN PORTABLE SANITATION AND SEPTIC PUMPING EQUIPMENT



Super Products

Worldwide Vacuum Technology - Since 1972



Booth 1054

Supersucker® with High-Dump Option

- › Rear Lift Height up to 60"
- › Unloads Efficiently
- › Heavy Duty
- › Low Maintenance
- › Easy to Operate



www.superproductscorp.com

800.837.9711

USABlueBook®

Get the Best Treatment™

Everything for Pumper & Cleaner Professionals

Visit us at the
Pumper & Cleaner Expo,
Booth # 13049 to
get your **FREE**
Camo Hat!

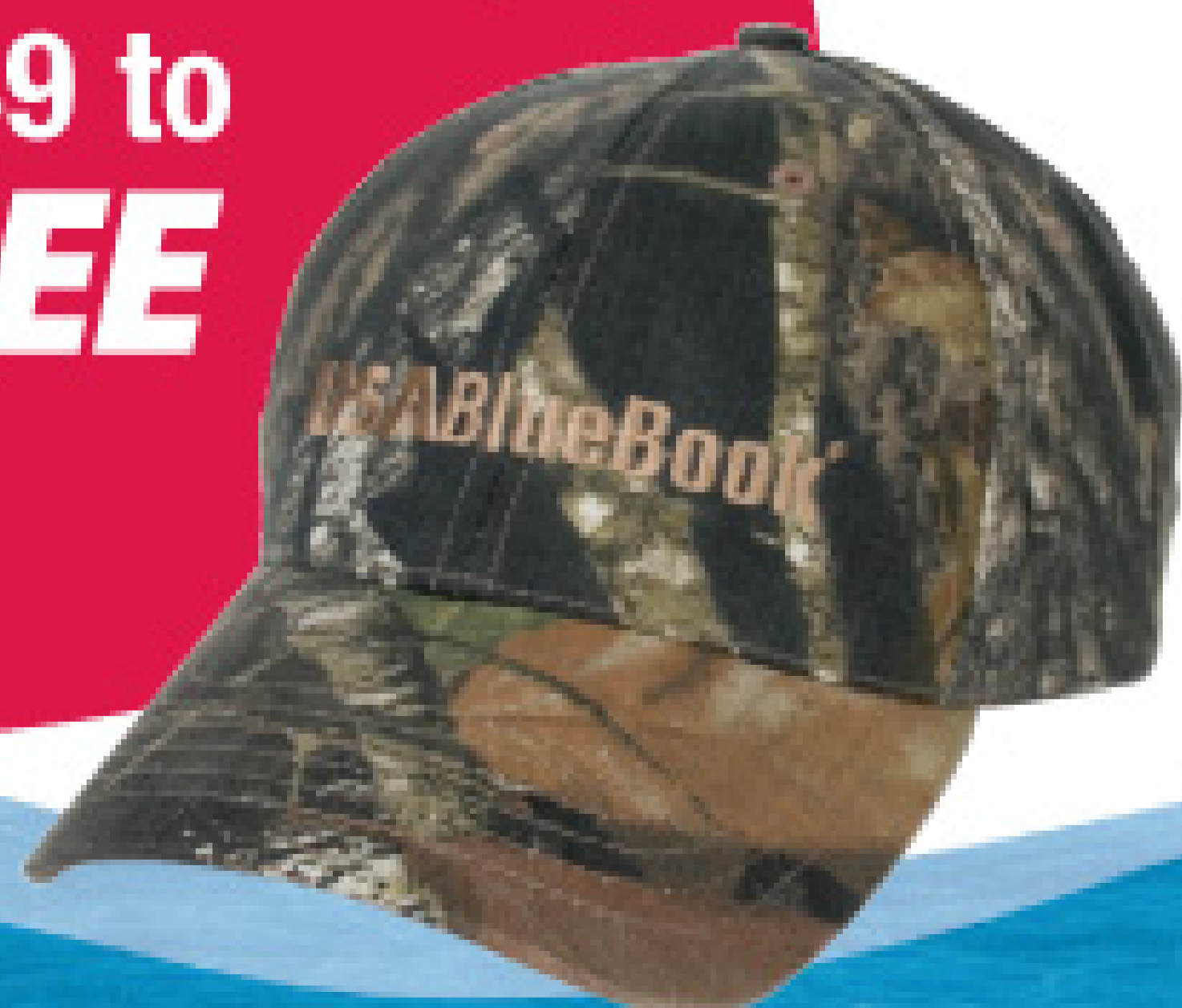

1-800-548-1234 • www.usabluebook.com

Introducing...

Now Available!
18"

the Most Durable & Economical Septic Lid in the Market Today.

- Durable Roto-Molded Construction
WILL NOT Crack Like Concrete!
- Lightweight Polymer is Easier to
Handle & Transport
- Corrosion Resistant Stainless Steel Screws Included
- For use with Standard 18" & 24" I.D. Corrugated Pipe
- Easy Slide-in
Installation
- Optional
Sand Filled

Cost Effective
6 Pack
Shipping

Give Us a Call for
More Information

800.868.0973



Don't Waste Money On Expensive Riser Systems!

**YOUR CHOICE OF:
STEEL, ALUMINUM OR
STAINLESS TANKS!**



**IMPERIAL
INDUSTRIES INC.
800-558-2945**

**WE DIDN'T JUST INHERIT THE NAME "IMPERIAL",
WE EARNED IT WITH "IMPERIAL" QUALITY/DESIGN/SERVICE**

**CUSTOM MANUFACTURED PARTS/REPLACEMENT PARTS • VACUUM PUMP SALES & SERVICE
"24" HOUR ON-LINE PARTS SHOPPING**



UNITS IN STOCK AND READY FOR DELIVERY:

- 2500 Gallon Steel & Aluminum Tanks
- 3600 Gallon Steel & Aluminum Tanks
- 4000 Gallon Aluminum Tanks
- Soon to be ready Blue I.H./3600 Gal. Steel Tank \$130,930

\$111,192.00 W/FET

Call Jim Stieber or Brad Rybarczyk for details!

**PORTABLE TOILET SERVICE UNITS, BOTH STEEL AND ALUMINUM
IN STOCK AND READY TO SHIP AT ALL TIMES!**

STOCK UNITS

- 875 Gallon Steel Tank 300/575
- 1100 Gallon Aluminum Tank 400/700
- 2150 Gallon Aluminum Tank 550/1600
- See our newest addition to our family of Slide-In Units at the February Convention!



Booth 2186



V&H AUTOMOTIVE
Marshfield, WI 54449
Randy Tischendorf



IMPERIAL
P.O. Box 1685 • Wausau, WI 54402
Tom Aerts

800-722-7382, ext. 244 | www.imperialind.com | 800-558-2945, ext.317

Weighty Issues

Posters want to know how heavy septage is, what drivers are paid and how to enhance customer education about onsite systems

This feature in Pumper® reports noteworthy conversations that take place in the Pumper Online Discussion Forum for industry professionals found at www.pumper.com. The forum is split into several topic areas: General Discussion, Business, Parts & Accessories, Portable Sanitation, Pumps & Blowers, Septic System Installation, Septic System Service & Maintenance and Trucks. Simply register with a user name and password and join the discussion!

Information and advice in Overheard Online is offered in good faith by industry professionals. However, readers should consult in depth with appropriate industry sources before applying such advice to a specific business situation.

Overheard Online

How much does septage weigh?

Question:

Anyone have a link or documentation on the average weight of septage?

Answers:

Water weighs 8.34 pounds per gallon. I use this number and, with a little variation, it works for septage as well as grease trap waste.



Start with the weight of water. The weight of septage will change depending on the total solids content.

Then there is a loyal customer whom I have worked for over the last 20 years and never mentions price, just asks when I can provide the service. These are the type of customers I will bend over backwards for.



I've always assumed grit weighs a lot more than septage, and could cause a weight problem if let go for long periods. It should be the same weight as sand.



I just did a quick Internet hunt and found that water has a specific gravity (SG) of 1.000 @ 39 degrees. Water containing particulates can have a SG of 1.005 up to 2.500.

Basically, the higher content of solids, the heavier the liquid. That's why the sludge is in the bottom of the septic tank. It's heavier. The 2.500 would have to be the absolute top end and much heavier than general sand or dirt. I usually ballpark it at 9 pounds per gallon.

How do we enhance customer education?

Question:

I believe we can all benefit by listening to each other's experiences. The latest topic is additives: good, bad, whatever. The worst additive is the trash that homeowners load into a septic system. I recently discovered a septic tank that had not been pumped for three years since installation. I know; I installed it. I had a pumper come out; it took him three hours to get all the wadded paper and whatever from the tank. A pump tank followed the septic tank, which had 2 feet of solids on the bottom and 2 feet floating. I don't even want to talk about the disposal field. Now, mind you, this is a house that sold for \$450,000.

As long as people's ignorance prevails, guys like me will always have something to comment on.

Answers:

One of the biggest challenges here is to get a homeowner to think of an onsite system as a living and breathing system, and not a landfill. I ask people if they would buy a house next to a landfill, and when they give me a strange look, I then ask them why they would want to de-value their property with cheap service

from companies that inject the waste back into the ground and ruin your system, and do it for a few bananas less than me.

The "I don't care" mentality is popular because there will be some low-priced company willing to give service away.



I hand out a sheet outlining the do's and don't of septic systems to all of my customers. On the sheet I talk about the right and wrong toilet paper to use: Avoid any two-ply toilet paper and only use single-ply paper. A lot of my customers use Scott Tissue, but Cottonelle works very well. I've had those jobs where it took three hours to clean a tank due to heavy toilet paper use.

What are wages for a new driver?

Question:

How much money per hour should an inexperienced and experienced route driver make?

Answers:

I would say it depends greatly on your market or region. In the Long Island, N.Y., area, you might be looking at \$9 to \$13 per hour for an inexperienced/new guy, or \$10-\$16 for experience/knowledge. And what about benefits, insurance and retirement?



I wish I could get help to work for that. Here in British Columbia, Canada, it's \$21 to start, and I trained him. He was already a pretty good driver though.



In Alabama, rates run from \$10 to \$12 per hour to start.



Helpers start at \$8 per hour. My best driver is close to \$20 per hour.

I have one part-time driver who is paid \$12 per hour with no benefits. I am in the Baltimore metro area.

One poster's rant about cheap customers

I feel there is a difference between a customer and a loyal customer. A person who is a price shopper is a customer who usually won't call me back once I give them a price. I'm only a little higher than Charlie Cheapo down the road, but these callers are worried about price, not service. When customers tell me they can get a tank pumped \$25 cheaper, I tell them it's a deal. Call him back; I will not drop my price. Sometimes I will get a return call a few days later and the same customer will want me to pump their tank because Charlie Cheapo has not shown up in the last three days. This happened to me twice last week. The customer then has the nerve to complain about the price on the phone, so I tell them we provide great service. We're on time, dressed in uniforms, make phone calls a couple of days after the service to make sure our service went well, answer all the customer's questions, etc.

Then there is a loyal customer whom I have worked for over the last 20 years and never mentions price, just asks when I can provide the service. These are the type of customers I will bend over backwards for.

To me, great service is not cheap, but it is valuable. ■



DML2000

The best Magnetic Locator on the market

- Easily pinpoint buried septic tanks, water valves, water meters, survey pins, iron pipes ...
- All weather operation; -20° to 120° F
- Works great in rain, sleet or snow.
- Waterproof Sensors; base of electronics to the crutch tip.
- Comes with a Hard Plastic carrying case or a soft-padded case.
- USA Bluebook P/N: 64978
- Best warranty in the business, a **LIFETIME WARRANTY**

Dunham & Morrow Inc.
 43676 Trade Center Pl., Suite 145
 Dulles, VA 20166 703-661-2144

www.magneticlocator.com



MUNCIE

GLOBAL MOBILE POWER

POWER TAKE OFFS
 HYDRAULIC MOTORS
 HYDRAULIC FILTERS
 GEARBOXES
 PISTON PUMPS

DC POWERPACKS
 HYDRAULIC VALVES
 HYDRAULIC RESERVOIRS
 WETLINE SYSTEMS & KITS
 SNOW & ICE REMOVAL

INNOVATIVE PRODUCTS FOR AN EVER CHANGING WORLD

Muncie Power Products, Inc. invites you to visit us at:

PUMPER CLEANER ENVIRONMENTAL EXPO
FEBRUARY 27-29, 2008

Come see our updated Family of Mobile Power Products.

BOOTH 7118

1-800-367-7867
www.munciepower.com

Member of the  **INTERPUMP GROUP**

Juggler™

The **ONLY** **NSF** **CERTIFIED**,

solid-liquid separator
for grease traps and
septic tanks that's
SMARTER and
GREENER than
a standard
Pumper truck!



Visit us at
Booth 9017
Feb 28 - March 1, 2008
at the
Pumper & Cleaner Show
in Louisville, KY

ISO
9001
2000

labrie
environmental group

Contact Robert Lamarche at ☎ 1 514 919-0347 | New video at www.labriegrup.com

DECALS 

FOR ANY TOILET ANY SIZE ANY COLOR

Booth 3201



10% OFF
CUSTOM DECALS
WHEN YOU MENTION THIS AD

**LOW COST
HIGH QUALITY
FAST TURNAROUND**

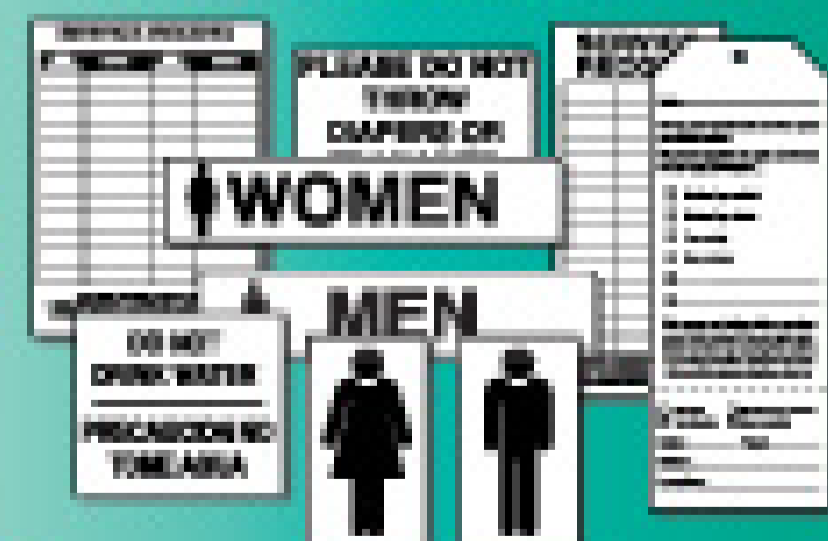

- Service Records
- Custom Decal Designs
- Die-Cut Shaped Decals
- Large Selection of Stock Decals
- Lack of Service Tags
- Caution/Warning Decals
- Signs & Safety Products

1.800.829.3021
www.screentech.com

ScreenTech
IMAGING
a division of Rosda Signs, Inc.

16931 S. State St. • South Holland, IL 60473 • Fax: 708-333-0209

**"DON'T BE EMBARRASSED AGAIN!"
HOW AWFUL...**

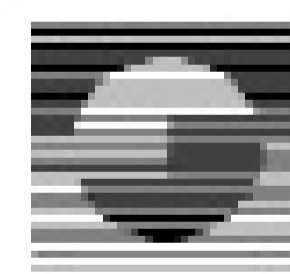

800-622-8768
sweetair.com

SWEET SEPTIC SYSTEMS, INC.
5701 Mother Lode Drive • Placerville, CA 95667
Fax: 530-622-1087

SWEET AIR™ FILTERING DEVICE
PAT PENDING

UPC Approved

HOW WONDERFUL...



Our Green is REALLY GREEN!



FIVE PEAKS TECHNOLOGY
231.830.8099 | www.fivepeaks.net
866.293.1502



GREEN RIBBON PROGRAM

Our commitment never ends! Five Peaks Technology continues to "Lead the Evolution in Portable Sanitation" through exemplary dedication and commitment to a safe and healthy environment. Our strategies include recycling our plastic, recycling our packaging materials, refined purchasing habits towards recycled products, extensive energy audits throughout our plants, and the purchase of hybrid company vehicles.

As a Green Ribbon Partner, Five Peaks is committed to our industry, to environmentally sound waste management and to energy saving practices. If you join us as we continue the path towards a GREEN ENVIRONMENT, others are sure to follow!

To learn more about the Green Ribbon Program, visit greenribbon.net



Booth 5069

Extreme Makeover IHI Style



Booth 8209

- 12 Models - 2 Styles
- Zero Tail Swing & Conventional Style
- Operating Weights 2,060 to 18,100 lbs.
- Digging Depths from 5'2" to 15'1"
- Control Pattern Change Valve Standard
- Multi-Function Hydraulic System



400 Production Court, Elizabethtown, KY 42701

800-538-1447

www.ihcompactexcavator.com

LOCATE WITH THE BEST

WHETHER YOU ARE JUST GETTING STARTED OR YOU ARE AN OLD PRO, you can rely on Prototek for the best flushable transmitter and receiver systems in the industry. **FLUSH AND FIND** Locate underground nonmetallic tanks and lines with our orange AT-12 flushable transmitter and AR-1 receiver. Locate in cast iron or nonmetallic lines with our blue FT-8 flushable transmitter and FR-1 receiver. Recycle your used AT-12s or FT-8s back to us for credit toward your next purchase. Use your AR-1 for tracing metallic lines or utilities with Prototek's powerful and versatile **BuzzBox!** Operates at 223 KHz, 3 watts max power, in 3 ranges, Ground rod and cables included.



EXPO SPECIAL
10% OFF KITS

Prototek

SEE YOU IN LOUISVILLE
BOOTH #3187



ECONOMICAL • EASY **800-541-9123**

www.prototek.net email: prototeksales@prototek.net

CADMAN / ALBERS

For Emergency or Temporary Storage of Liquids



Booth 2000

- Safe, affordable enclosed storage.
- Up to 1.3 million U.S. gallons of capacity.
- Various agitator options.
- Neighbor friendly odor control.
- Blends in with the surroundings.



We also offer fully portable, transportable systems. Your containment solution is only a phone call away.

Cadman
POWER EQUIPMENT
AGRICULTURAL MACHINERY
& IRRIGATION EQUIPMENT

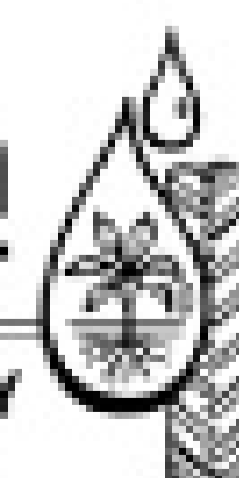

38 Main St. • Courtland, Ontario, Canada

1-866-422-3626

www.cadmanpower.com

NEW! *Work-Ready Restroom & Septic Service*
 featuring **progress tank**
The Industries Finest Light Weight Aluminum Tank.



2800 Gallon Septic Tank
 Masport HXL15 – 360 C.F.M.
2008 International 33,000 G.V.W.
 4400 Series- 260 Horsepower
 6 speed transmission
 Air brakes
\$89,900
 from **\$1798** mo.



2008 Kenworth T300
 22,000 lb G.V.W. rating – Non CDL
 Cummins, Allison automatic,
 hydraulic brakes, A/C, AM/FM, air driver's seat,
 turbo exhaust brake.
1700 Gallon Aluminum
 400 fresh / 1300 waste
 Masport HXL 4, Burks washdown, Hot shift PTO,
 4" discharge. Unit hauler & tow package.
\$73,900 from **\$940** mo.



2007 LT9500 Sterling
 MBEW 410/450 HP, 10 Speed transmission
 58,000 GVW, 18,000 lb. / 40,000 lb. axles
4200 Gallon Septic Service
 Masport 400CFM pump and tool box
\$129,000 Plus FET
 from **\$2,560.** mo



Great Lakes Equipment, Inc.
 Chicago, IL
 Fax: (815) 462-4017
 Email: info@greatlakes-equipment.com
www.greatlakes-equipment.com

Call: (815) 955-3790

Omnivore™
Grinders
By Liberty Pumps



Booth 9215



Hungry by Design

With new V-Slice™ cutter technology, a stainless steel impeller, and powered by a motor with solid state starting circuitry, the Omnivore™ is not only hungry - it's ready to shred anything in its path.

Omnivore™ LSG-Series
the most advanced
grinder available.

Liberty Pumps

1-800-543-2550

www.libertypumps.com

Copyright © Liberty Pumps, Inc. 2006. All rights reserved.

Gallup **AGITATOR**
SYSTEMS INC.
BROOKS, AB

Vac Trucks, Trailers, Tank Bottoms

Tel: (403) 793-4862

• Specially Designed To Eliminate • Maximum Versatility
Hydraulic Oil Contamination Centrifugal Pump System



Booth 16016-17017

- The revolutionary new system that will save you time and money
- With high quality and optimum performance the possibility of versatility is unmatched.
- The Gallup Agitation System is designed for the removal of solid waste materials
- Get the Gallup Advantage Agitation System today.

435 GALLON VACUUM TANK



#4026 & 4027



- 1/4" Aluminum Construction
- Conde Super 6 Pressure Vac Pump with 5.5 hp Honda Electric Start
- 12 Volt Water Pump
- 300 Waste/135 Fresh
- 25' Hose and Wand
- 2" Sight Eyes in Waste
- Sight Tube on Fresh Water
- Completely Self-Contained
- Ready to Work

OTHER SIZES AVAILABLE

Robinson Septic Service Inc.

125 Rockrimmon Dr., Bellefonte, PA 16823 • f: 814.353.0263 • email: honeydippers@aol.com

1.800.252.3848 • www.robinsonseptic.com



For over 35 years
Super Products
has included
**ROOTS™ Vacuum
Blowers in their
hard-working line
of sewer cleaning
trucks...**

Super Products has built a solid reputation for the quality and performance of their products, and they rely on Dresser Roots to provide the vacuum blower that's at the heart of their products' high performance.



... And Now They're Getting Even Better

ROOTS® TRI-NADO™ TM (Truck Mount) tri-lobe blowers have been re-designed, incorporating the latest technology for reduced noise and vibration. In the early 1900s Roots patented tri-lobe technology, and has been continuously manufacturing rotary positive displacement blowers and exhausters ever since. Before you settle for another brand, check out the new features on the New TRI-NADO TM. Contact us for more information and to locate your local distributor.



Roots

Toll Free: 1-877-363-7668
www.rootsblower.com

Signature Service

Portable restroom with a backstage pass is covered with autographs of country music luminaries

An unassuming gray PolyPortables Inc. restroom has struck a chord with musicians and achieved backstage celebrity status at the annual Country Fever music festival in Pryor, Okla.

The Lighter Side

By Ken Wysocky

And no one's happier about it than Tammy and Stacey Hillis, the president and general manager, respectively, of At Your Service, a portable sanitation business in nearby Tulsa that services the huge music celebration. Bringing new meaning to the words "signature service," the restroom is covered with 75 to 100 autographs of musicians who've played at the country music extravaganza for the last three years, reports Tammy Hillis.

"Stacey came up with the idea — he's always thinking outside the box," Hillis

relates. "He really likes the singer Thomas Martinez, so three years ago, he asked him to autograph the restroom. He thought it would be fun."

Martinez agreed, and the rest is star-studded history. The restroom, which has become a backstage fixture at the concert festival, has now been autographed by luminaries including Willie Nelson, Trace Adkins, Montgomery Gentry, Shenandoah, Lonestar, Trick Pony and the Oak Ridge Boys.

"People backstage look for it now," Hillis notes. "We forgot to bring it this year, and they called us and asked us, 'Where is your signature toilet?' So we had to bring it on out."

Initially, musicians either loved the idea or hesitated a bit before signing it. Now, some artists want to sign it before anyone even asks them. Only one singer, Carrie Underwood, has declined to autograph the restroom, Hillis notes.

"Her manager wouldn't let her sign it,"



The Oak Ridge Boys' bearded William Lee Golden pauses for a snapshot with the Hillis family, Stacey, Tammy, Skyler and Addison. (Photos courtesy of At Your Service)

Hillis explains.

So what does At Your Service plan to do for an encore when the restroom is covered entirely?

"I guess we'll start another one," Hillis says. ■

Now, some artists want to sign it before anyone even asks them. Only one singer, Carrie Underwood, has declined to autograph the restroom.



Singer Trace Adkins stops backstage to add his name.



Duane Allen of the Oak Ridge Boys signs the celebrity restroom.



Country singer Neal McCoy poses with Addison Hillis.

Septic Reminder Color Postcards



DOLLOFF SEPTIC SERVICE, LLC

Are you marketing yourself properly?

Postcards are cost effective, easy to hand out and inexpensive to mail.

Show Special

Design setup FREE. Order before March 31, 2008 and get *Free shipping

For details visit us at www.postcardprinting.com

or call Toll Free **1-888-334-4553**

*Call for details

"Duel Power Lid"

Plugs, Lids & Adaptor Rings
 Sizes Available:
18", 24", 30" & 36"

Fergus Power Products
 Providing "Environmental Products"
The Company who maintains a pulse on the environment!

Booth 3217

Toll Free **1-800-243-7584**
 E-mail fpproducts@prtcl.com

SAVE Over \$5,000 A Year!

By Saving 1,800 Gallons of Fuel!



- **24-Volt Electric Driven Vacuum System** replaces Engine Driven PTO System
- **Electric Hybrid Allows Vehicle Shutdown at Every Stop!**
- **Engine Does Not Run During Services**
- **Save THOUSANDS in Annual Fuel Costs on EACH Truck!** (Based on 40-8 minutes services per day)!
- **Super Quiet! Service Noise Restricted Areas with Ease**
- **Optional Onboard Management System**

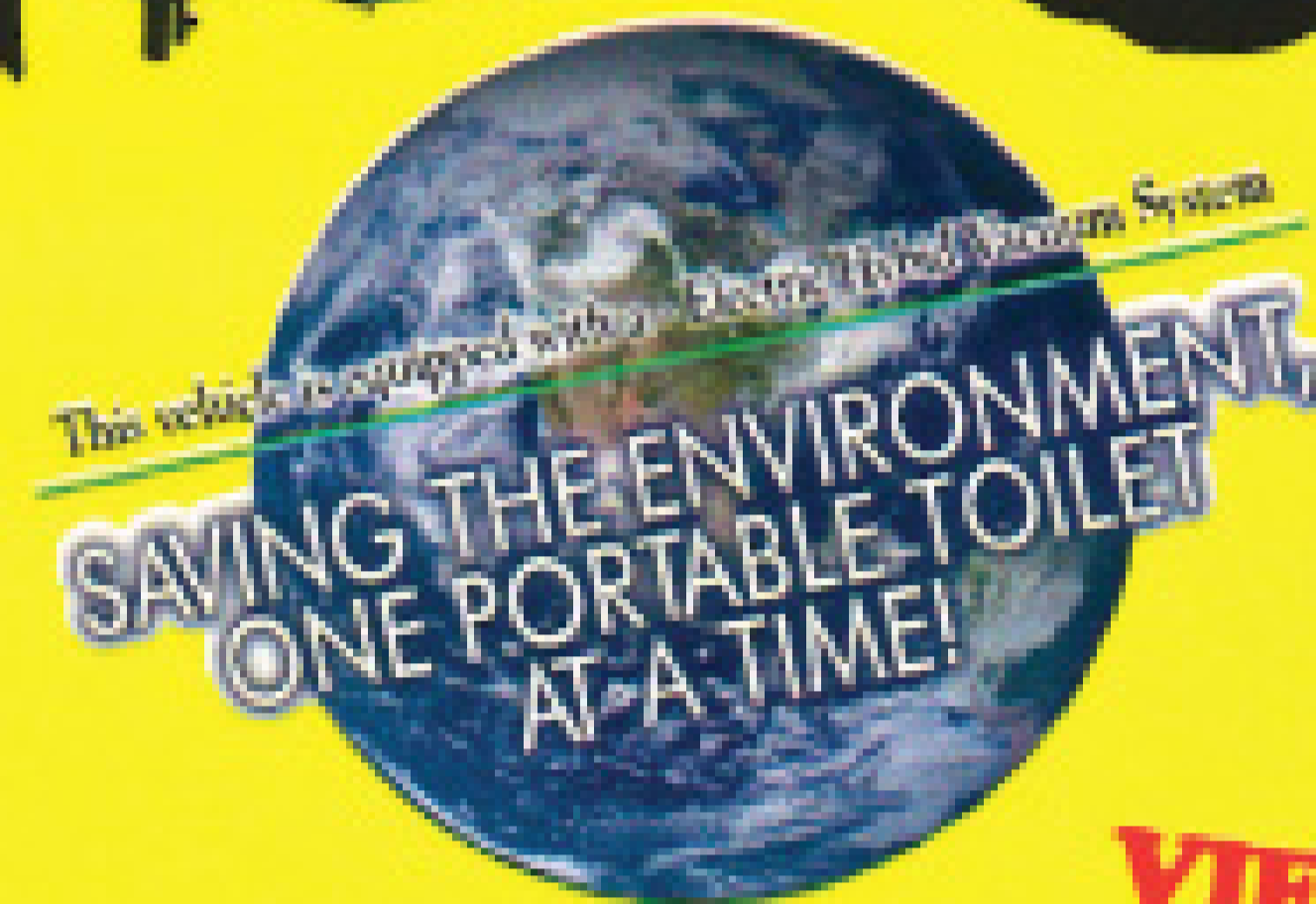

**VIEW A
VIDEO CLIP
OF THIS HYBRID
ON OUR WEBSITE!**



1-800-927-8750

www.fmitrucks.com

Just Starting Your Business? YOU NEED A SERVICE TRAILER!



- **Twin Poly 75 Gallon Fresh Water Storage**
- **325 Gallon Waste Capacity**
- **Low WorkMate Easy Work Station**
- **Great Product Storage**
- **Upgraded 5,200# Axes**
- **Pick Up & Deliver Two Units**
- **Super Low Operating & Insurance Costs**



**Under
\$15,000
COMPLETE!**



SANITATION INNOVATIONS
FMI TRUCK SALES & SERVICE
Portland, Oregon

**Visit us at the
Pumper Show
Booth 4002/4003**

Your Source for Safe, Hands-Free Cleaning

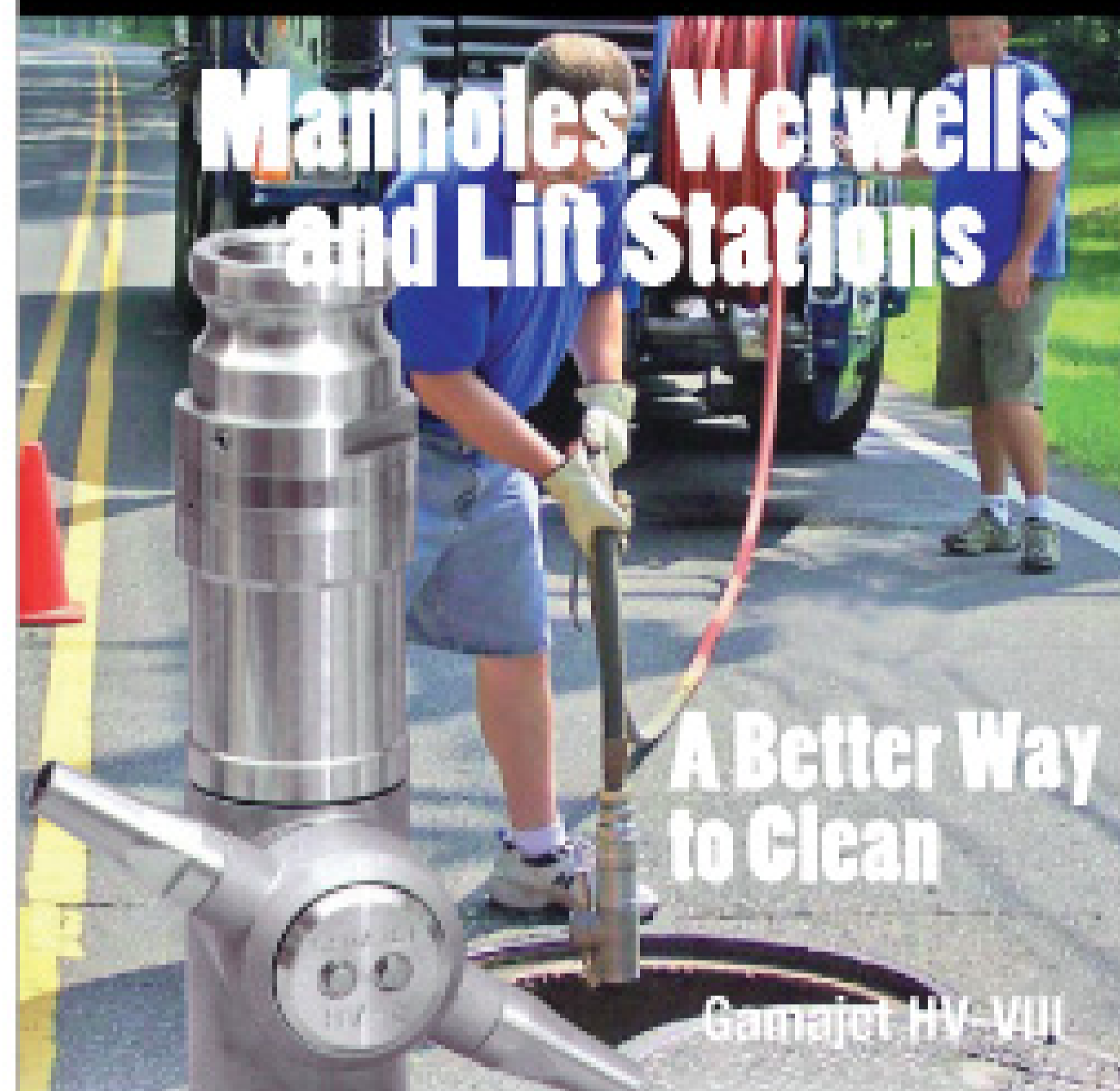

**Manholes, Wetwells
and Lift Stations**

**A Better Way
to Clean**

Gamajet HV-VIII

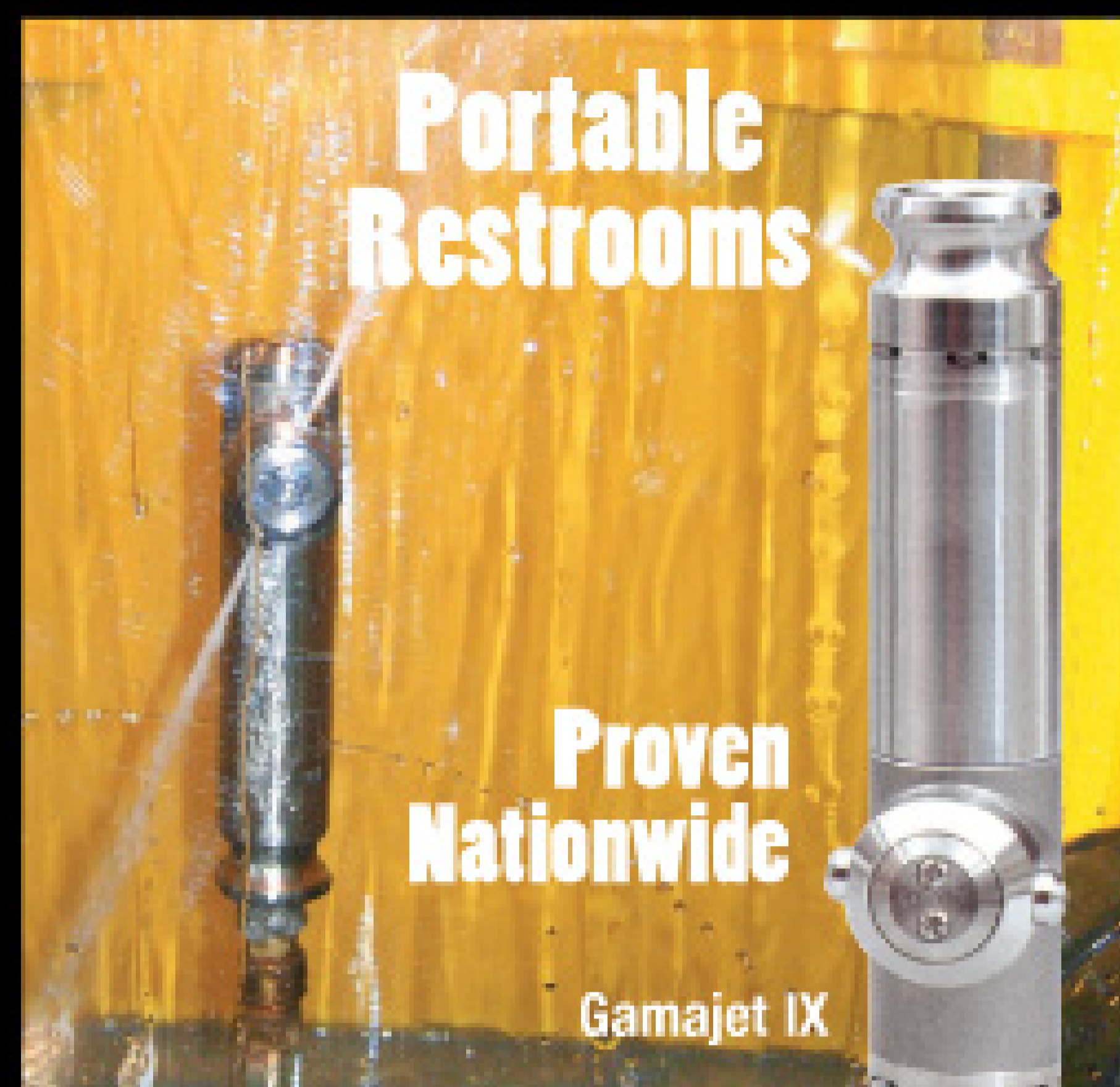

**Portable
Restrooms**

**Proven
Nationwide**

Gamajet IX

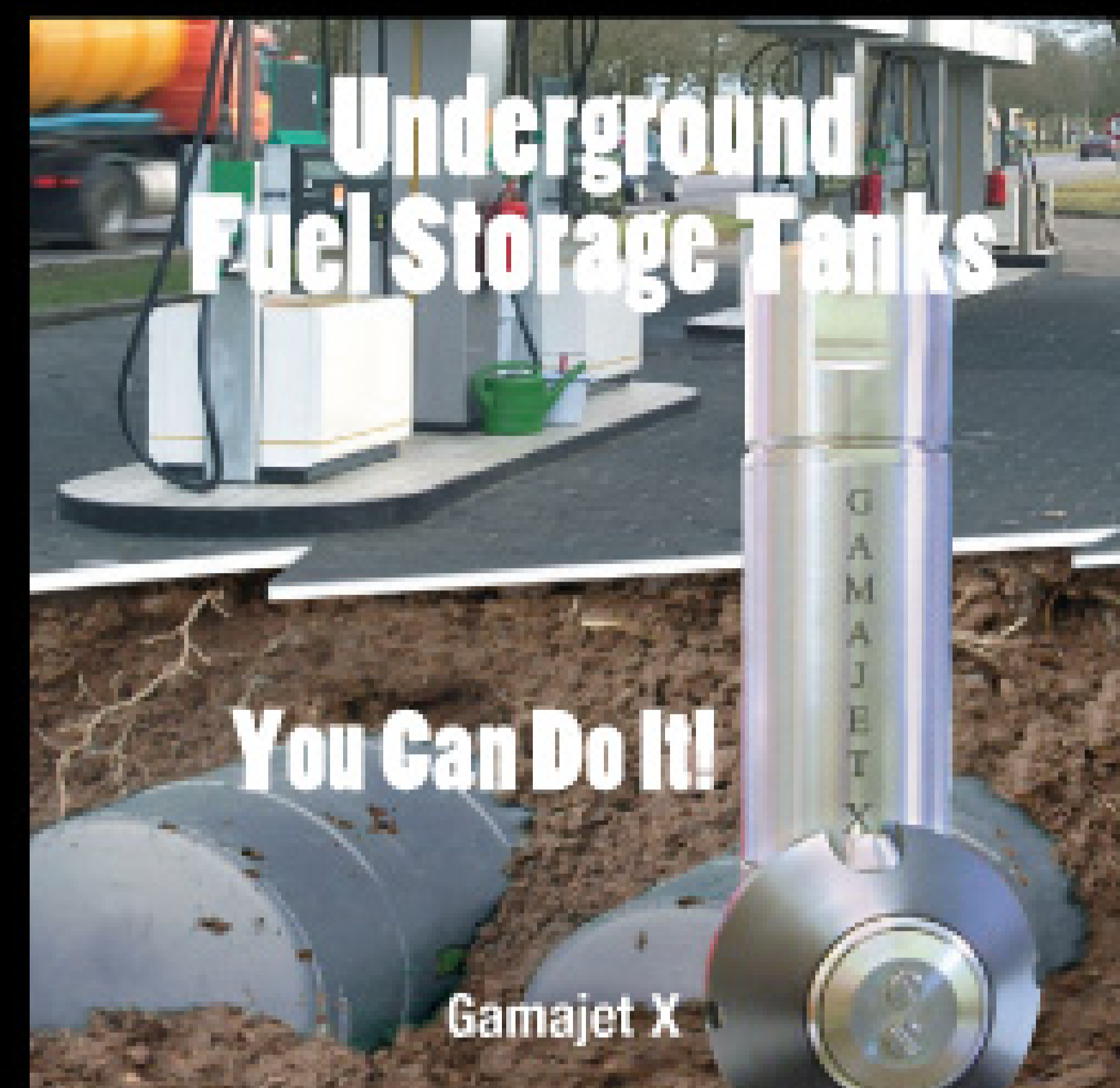

**Underground
Fuel Storage Tanks**

You Can Do It!

Gamajet X

GAMAJET®

Gamajet Cleaning Systems, Inc.

Powerful Cleaning - Easy & Safe to Use

The secret to the effectiveness of all Gamajet Cleaning Machines is the power of rotary impingement cleaning. Powerful rotating jets simplify your cleaning jobs. See for yourself - call or visit our website for **FREE** videos.

1-877-426-2538 www.gamajet.com

Visit us at the Pumper Show Booth #8155

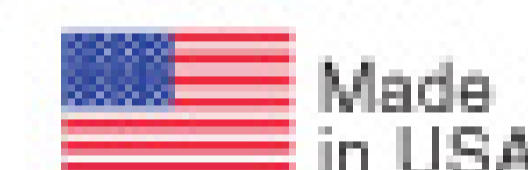

Toll Free 888-207-2074

Fax (479) 770-6089

WILCOX TRUCK SALES, INC.



Lowell, Arkansas

... ESTABLISHED 1979

I-540 Exit #78 & Hwy 71B

2 hours East of Tulsa or 1.5 hours South of Joplin

www.wilcoxtrucksales.com

1994 Freightliner FLD120

3406E Caterpillar, 355 HP, 9 Speed, 4 Bag Air Ride Suspension, 3.91 Ratio, 219" WB, 3000 Gallon Vacuum Tank, 8) Matched Virgin Drivers.



1994 Kenworth W900

3406 Cat, 425 HP, 10 Speed, Engine Brake, Excellent Radials, 8 Bag Air Ride with New Timbren Suspension Enhancements, New 80 Barrel Custom Built & Painted, Machine welded Vacuum Tank and New Juroop R260 Vacuum Pump



LEASING SOLUTIONS



If you have special or unique needs, for straight answers and a quick response, call Jim Thomas.

Conserve your working capital. Keep existing credit lines intact, and enjoy the security of knowing financing is there when you need it. We offer loan and leasing plans tailored to individual needs.

- Portable Toilets
- Pumper Trucks
- Water Jetters
- Vacuum Trucks
- Sewer Equipment
- TV Inspection
- New and Used Equipment

- Programs offer longer terms for older equipment.
- We do start ups.
- 90 Day Delayed Billing.
- Seasonal Payment Programs Available

Get Pre-Approved for the Pumper & Cleaner Environmental Expo

Prompt, no nonsense financing designed to meet individual requirements. Payment plans that are generally lower than other finance plans. With years of experience, we understand the competitive nature of your business. **We're prepared to act quickly and decisively!**

Toll-Free 877-333-4539 • www.keycommercial.com



"Getting You The Credit You Deserve"

GUZZLER

“No Regrets.
I bought a Guzzler.”

Contractors who try a Guzzler buy Guzzler...*again and again and again.*

The choice is simple because Guzzler vacuum loaders are:

- Easy to operate
- Easy to clean
- Easy to maintain

And, with the Guzzler NX, you experience a lower total cost of ownership, with exceptional productivity through unmatched loading rates, plus best-in-class fuel efficiency.



GUZZLER
Subsidiary of Federal Signal Corporation

Find out if you qualify for a free demonstration.
Just go to www.guzzler.com/requestdemo.asp today, or call 1-800-627-3171.

Your Turn Key Solution To Trucks "Ready to Go"



Booth 7141



2007 International 4200
Auto. transmission, air brakes, A/C
2000 Gallon - 1100 / 400
Masport HXL4, Dual service
\$76,200 from...\$1,524 mo.

NEW! 2007 Peterbilt 340
Cummins diesel, auto trans.
3800 Gallon Aluminum- 2 Compt.
Masport HXL400 Water Cooled
400 CFM Vacuum Pump
Jetter System and Tool Box.
\$134,000 Plus FET
As Low As **\$1838 mo.**

Contact:

Glenn "Mac" McCallister Donnie Moyers Jeff Kalp
gmmccallister@semotank.com tdmoyers@semotank.com jnkalp@semotank.com

2008 Sterling Bullet - 20,500 GVW
Cummins 305 HP / Automatic trans.,
1250 Gallon Restroom Service
900 Waste / 350 Fresh / Masport HXL4
Burks washdown / Hot Shift P.T.O.
\$66,400 Lease from \$1328 mo

2008 Peterbilt - 33,000 GVW
260 HP, 6 Speed transmission.
2800 Gallon Septic Service
Masport HXL15, toolbox
\$89,000 from \$1221 mo.



Front Lift Tank Hoist
Full Opening Rear Door

800-264-8348 Voice
573-547-8420 Fax
573-450-5196 After Hours
www.semotank.com

SEMO/BAKER ACRO

United to Broaden Your Tank Services
456 Semo Lane, Perryville, MO. 63775

OFF THE SHELF

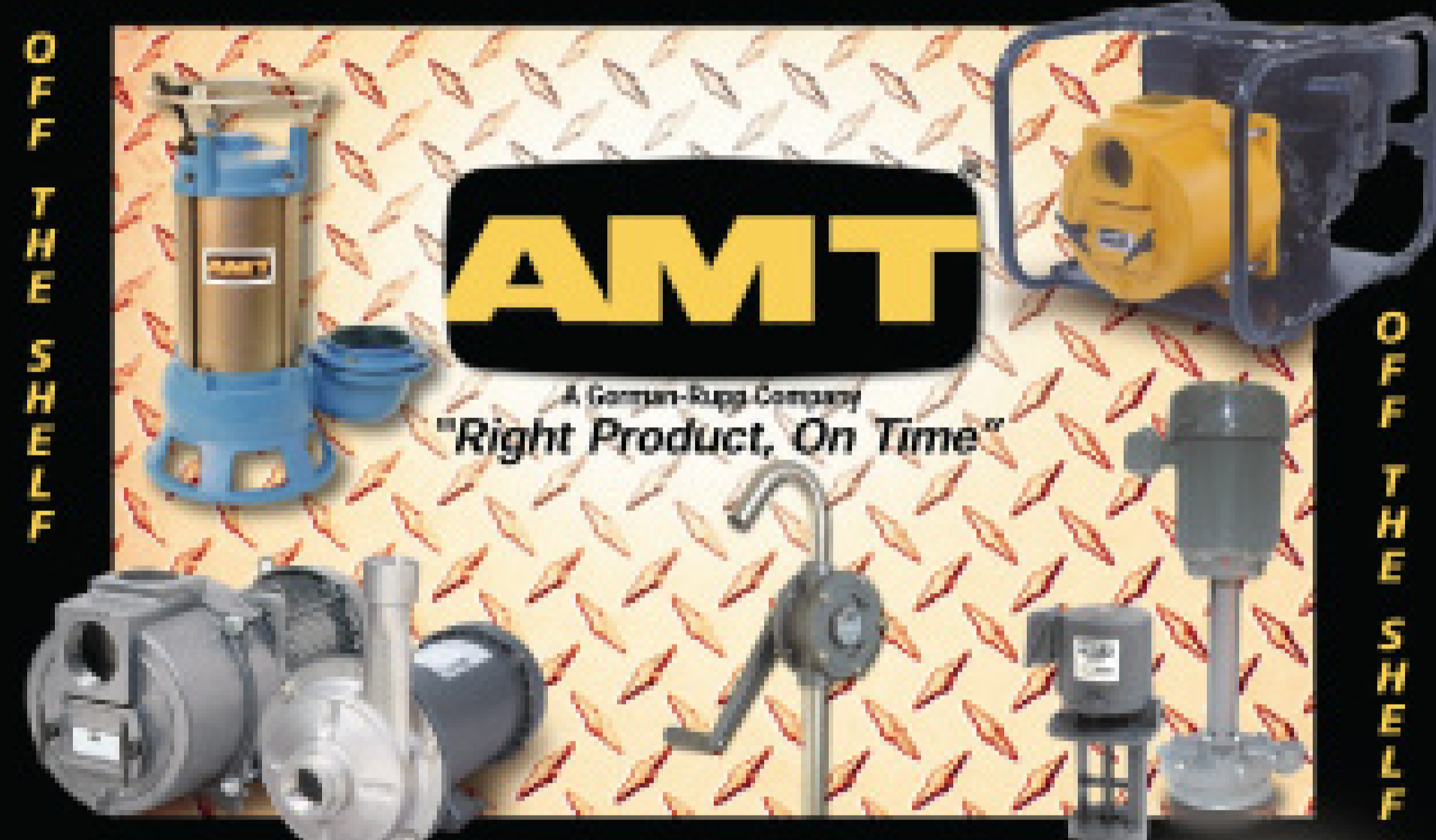

OFF THE SHELF

12 VOLT DC HIGH HEAD WASHDOWN PUMP

1 HP Washdown Duty Motor for Severe Operating Conditions

Investment Cast 316 Stainless Steel, Cast Iron or Cast Bronze Construction with High Efficiency Stainless Steel Impeller on all Models

Discharge Port Rotates in 90° Increments

Four Front Drain Plugs

Max. Flow 56 GPM Max. Head 80 Ft (30 PSI) Max. Temperature 200°F

The AMT 12 Volt DC Washdown Pumps are designed for pumper, septic service, OEM, and marine applications requiring a DC motor. The motor has one hour duty rating and is furnished with a grade 303 stainless steel shaft. Pull-from-rear design for ease of servicing without disturbing piping.

American Machine and Tool Co. Inc. of Pennsylvania
400 Spring Street
Royersford, PA 19468

Call us toll free at 888-268-7867 or visit our website www.amtpump.com

Custom Built YOUR Truck or Pull-type Chassis or OURS



- Septic Systems
- Municipal Waste Control
- Ag Operations
- Supplier for Brass or Stainless Steel Gate Valves
- Vacuum Pumps of All Sizes

Call Keven Schroeder Today! 1-800-795-8551 ext. 124

Vertical Electric Pump

Agitate, transfer or top fill hauling units. Choose from standard lengths of 4' - 6' - 8' - 10' - 12', other sizes available upon request



Galvanized Construction!

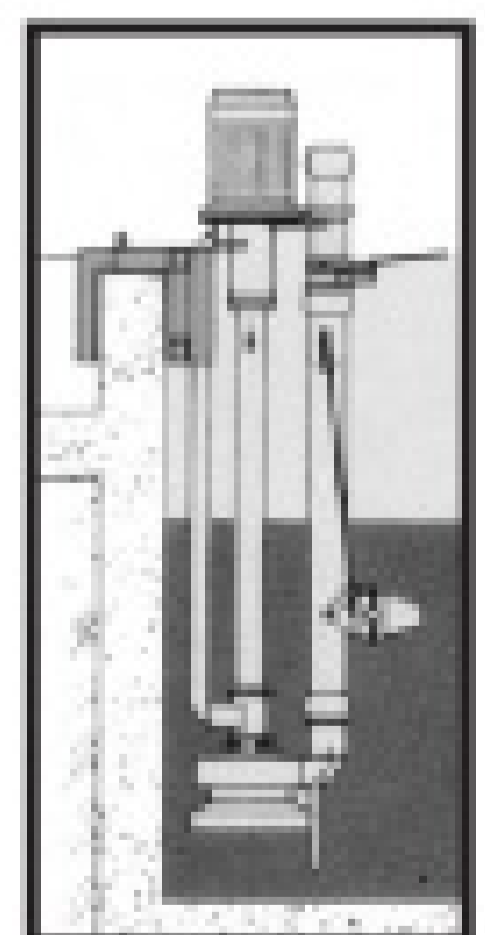

BALZER INC.

STEWARDS FOR **AG** ENVIRONMENTS

CO. RD. 27, Box 458
Mountain Lake, MN 56159

1-800-795-8551

www.balzerinc.com

PERFORMANCE. YOUR NAME DEPENDS ON IT!

The Aero-Stream® System for septic repair and maintenance



**Give your customers peace of mind
and put yourself at the top of their list.**

Making customers happy is the best way to build your business. And that's exactly what our revolutionary septic remediator can do. **Easily installed in an hour or less,** the **Aero-Stream® System** is designed to both restore and maintain conventional septic systems without the hassles, damage and high costs associated with yesterday's solutions. **It's simply the best way to fix septic problems and prevent them. GUARANTEED.**

Add the **Aero-Stream® System**
to your arsenal.

- Create a new profit center
- Build your reputation as a solutions provider
- Gain customer loyalty by providing a cost-effective solution

 Patented system,
UL listed outdoor appliance



Visit www.aero-stream.com or call 877-254-7093

We pay attention to the details.

- Fabricated to the best industry standards using the highest quality products available
- Custom configurations to your specifications
- VISA, American Express, MasterCard, & Discover
- Fast, same day shipping, low freight rates



Booth 4160

ATLANTA RUBBER & HYDRAULICS

1640 D Sands Place
Marietta, GA 30067
Toll Free: 800.282.6272
Phone: 770.955.5225
Fax: 770.955.2377
e-mail: dragsdale@atlantarubber.com



**We Build Trucks
That Suck!**

VSI Vacuum Sales Inc.

51 Stone Rd. | Lindenwold, NJ 08021

888-VAC-UNIT | 888-822-8648 | Fax: 856-627-3044
E-mail: vsisales@aol.com | www.VacuumSalesInc.com

NEW EQUIPMENT CUSTOM BUILT TO YOUR SPECIFICATIONS



(13298 A & B) 2008 Peterbilt 340 cab & chassis with a New Presvac 3,200 gallon, c/s, DOT certified 407/412 vacuum tank; Dump Type with full open rear door & a Presvac PVB 750 vacuum-pressure pump.



(2104V) 1999 Freightliner FL60 with a 1,000 U.S. gallon waste, 250 U.S. gallon water; 250 U.S. gallon mix; 3-compartment, Stainless Steel vacuum tank, with a NVE 184 vacuum pump and washdown system.



(2362V) 1996 International 4700 cab and chassis with a 1,800 U.S. gallons, 2 compartment (1200 waste/600 water); carbon steel, vacuum pressure tank with jetting system.



(13289) New Presvac 2,000 U.S. gallon 2-compartment (1500/500), Aluminum vacuum tank, with a Moro M3 vacuum-pressure pump installed on a 2007 Chevy C7500 Cab and Chassis.

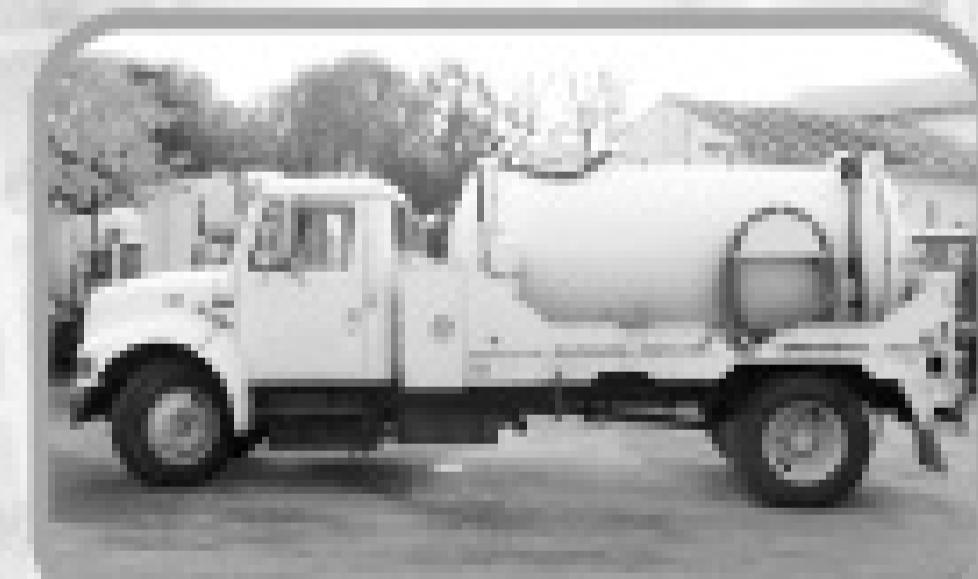

(8734) 1998 International 4700 with a 1,500 U.S. gallon, 2-compartment (1100/400 split), Carbon Steel; portable toilet service unit.



(13281B) 2007 Sterling LT9500 new Presvac, Powervac 3800, 3,250 gallon DOT, wet/dry industrial, vacuum tank loader.



(13329V) 2001 Freightliner C120 cab and chassis with a new Presvac 3,200 gallon DOT 407/412 Certified Vacuum - pressure tank.



(5371V) 1994 Mack RD6905 w/ Presvac 4,400 Carbon Steel 2-compartment DOT Cert Vacuum Tank.



(13297A) 2007 Peterbilt 340 with a Presvac 3,600 gallons (US), aluminum vacuum tank unit.



(8734C) 1997 Ford LT9513 with a Presvac 5,000 U.S. gallons; Carbon Steel; Vacuum-pressure tank.



Your truck specialists in the solid and liquid waste industries.

If you are in the market for a refuse vehicle, make Rush Refuse Systems your resource. We have one of the largest inventories of work ready trucks in the country, representing the industry's leading brands. Whether you need to buy, rent or lease, we have a full spectrum of financial resources available. And, we support you through our Rush Truck Centers network of over 50 locations — with an extensive parts and accessories inventory, highly skilled ASE-certified service professionals and exceptional body shop capabilities.



Peterbilt 340 Industrial Vacuum Trucks

Automatics and Standards in stock ready for delivery. DOT 407/412 3150 Gallon Cusco units. Moro PM100 Pump, Hydraulic full opening rear, Vibrator Box, Air actuated valves, Full Walkway with handrail, 20 Ton Dump Capacity Cylinder.



Peterbilt 340 Standard Vacuum Trucks

Automatics and Standards in Stock ready to go to work. Non Code 3600 Gallon Pik-Rite Tank. Masport HXL400WV Liquid Cooled Pump, Aluminum Hose Trays, Internal Primary to secondary Piping for clean mount. 10 yr Tank Warranty Standard. Options can be added before delivery. Compare our standard Specs to anybody!



2007 Peterbilt Model 357 Roll Off

Pre 07 Emission, Cat or Cummins, 8LL Transmission, 20 Fr/ 44-46 Rears, Air Trac or Hendrickson Suspension, 60K or 75K Hoists, Pioneer and O'Brian Tarpers, Mounted or Cab and Chassis Still Available!



Booth 4210



2007 and 2008 Peterbilt Cab and Chassis

Whether you're putting an old tank on a new truck, or custom building a truck the way you've always wanted, call us and choose from a wide variety of models and specs on the ground. Fast shipping available to your destination. Tank dealers and manufacturers welcome.

877-661-4511

Refuse Sales Team: Gregg Wilkinson | Jason Guzauskas | Jesse Fullilove | Hal Holloway
refusesales@rush-enterprises.com

8810 IH-10 East | San Antonio, TX 78219

Refuse Systems



www.rushrefusesystems.com



Check Your Vacuum Relief Valve



Richard Davis of Quick Response Septic Service, Grass Valley, Calif., sent in these photos of his 2000 GMC Topkick vacuum truck, which suffered a collapsed tank while performing emergency service for the city of Roseville in northern California. Working with about 30 other pumpers to prevent sewage from going into a nearby stream, Davis was on flat ground, with a hose in a manhole taking on sewage when he heard a loud bang. He returned to the truck to find major damage. The 2,000-gallon steel tank

with two baffles had to be scrapped. Davis is replacing it with a tank from Lely Manufacturing Inc., that he had removed from another truck.

The implosion was traced to a non-functioning vacuum relief valve attached to his 236-cfm Battioni pump. Davis said all the pumpers at the scene shut down their trucks and checked their vacuum relief valves before continuing with the job. After the mishap, Davis replaced the vacuum relief valves on his fleet of six trucks.

"The moral of the story is to make sure you check the vacuum relief valve," Davis said, hoping his advice will save other contractors from the same fate. The bill to replace the tank and put the truck back in service will be about \$15,000, Davis said, while the cost of a vacuum relief valve is about \$40. He doesn't expect any insurance to cover the damage. "It's smart to replace the vacuum relief valve every two or three years. And it sure costs a lot less than if you have a problem," he said. ■

O'BRIENTM MANUFACTURING
A PRODUCT OF HI-VAC CORPORATION

To order an O'Brien® Hydrojetter™ unit contact us at:
740-374-2306 • Toll Free USA: 800-638-1901

Jetters That Pay for Themselves. Again, and Again, and Again!

The first time you put an O'Brien® Hydrojetter™ to work you'll know it's a piece of equipment you can depend on. For over 50 years, we have worked closely with sewer cleaning professionals on the job to develop the perfect equipment to fit any application.

These tough, innovative machines are built to pass the test of time. And pay for themselves – again, again, and again.

HydroJetter
A SMART BUSINESS DECISION



Booth 4115

www.obrienmfg.com

What Makes Us Different... Simple!

Quality Products, Inventory, and Dependable Service
For the Liquid Waste Industry

Hoses and Accessories By:

- Plastiflex • Kanaflex
- Tigerflex • Dixon • PT
- Ever-Tite • Banjo
- Goodyear • Parker • Piranha



JGB specializes in providing hose and fittings for high pressure and water blasting applications up to 20,000 psi.

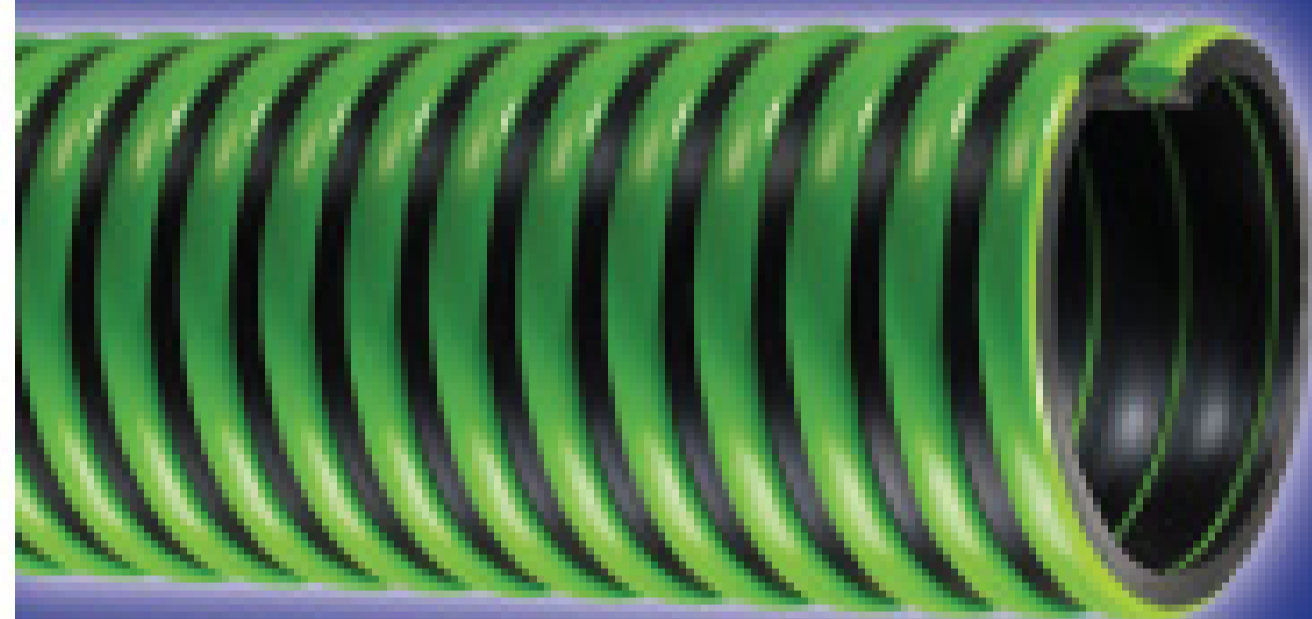

Green and Black Suction Hose

- Standard for the industry • Rugged, Lightweight and Resistant to all weather conditions: -40F to 160F.
- Bends Easily and slides just about anywhere. • Perfect for Septic handling, liquid waste slurries, grease traps, oil skimming and Liquid or Dry Chemicals

Bulk:	Assemblies Coupled MXF Quick Connects Aluminum:		
1.5" = \$1.15/ft	2" x 20" = \$43.50	3" x 20" = \$73.99	4" x 20" = \$119.95
2" = \$1.58/ft	2" x 25" = \$50.95	3" x 25" = \$87.25	4" x 25" = \$142.00
3" = \$2.85/ft	2" x 33" = \$62.50	3" x 33" = \$108.75	4" x 33" = \$179.95
4" = \$4.99/ft			
6" = \$10.10/ft			



180 AR

- Temperature Range -40F to 140F
- Heavy Duty Abrasion Resistant Suction Hose for Vacuum Trucks or handling Abrasives.
- SBR Rubber blended with Static Carbon Black, rigid PVC Helix, Smooth Bore, Corrugated O.D.
- Also known as Bumble Bee or Crushproof Hose

2" = \$3.13/ft	3" = \$5.28/ft	6" = \$16.79/ft
2-1/2" = \$4.00/ft	4" = \$8.70/ft	8" = \$27.97/ft

HI-VAC PLASTIFLEX HOSE

- Polyethelene Construction Corrosion Resistant and Extremely Flexible, even at Sub-zero Temperatures.
- Perfect for Removal of Liquids and Waste Materials.
- Resistant to Kinking and is crushproof & includes cuffs. Standard Lengths only.
- Also known as Bumble Bee or Crushproof Hose.

	10'	15'	20'	25'	30'	35'	40'
2"	\$32.50	\$48.50	\$64.75	\$81.00	\$97.00	\$113.25	\$129.25
3"	\$52.75	\$81.00	\$106.00	\$131.50	\$158.00	\$184.00	\$210.50

Add \$8.50 for 2" MXF Quick Connects Aluminum. Add \$15.95 for 3" MXF Quick Connects Aluminum



Ph: 315-451-2770 • FAX: 888-451-6743

Visit us at Booth #132 at the Pumper & Cleaner Expo.

JGB
enterprises inc.

You Can't Buy A Better Reel.

Hose Reels for Cleaning and Pumping

- ✓ High pressure washing and cleaning
- ✓ Sewer, septic, portable toilet cleaning
- ✓ Video pipeline inspection
- ✓ OE vehicles and aftermarket upgrades
- ✓ Extra rugged, long-lasting design
- ✓ Complete custom capabilities



Download or call for your FREE Guide to Ordering Pumper/Cleaner Reels
<http://go.hannay.com/U16>
877-467-3357

 **Hannay Reels**
The reel leader.

We Squeeze the Crap Out of Water™

Rotary Thickening and Dewatering

Simple systems that are totally enclosed, compact and easy to operate.



PH: 269-673-9559
www.primesolution1st.com
Made In USA

Septic-Scrub™

The First Choice for Pumpers to Restore and Maintain Drainfields

Backed By Science ■ Proven with Experience ■ Many Satisfied Homeowners

Septic-Scrub™ is a superior product for the maintenance and restoration of septic system drainfields. Customers appreciate that it is environmentally safe, contains no organic chemicals and does not produce any toxic by-products. Most importantly, **Septic-Scrub works.** It breaks down sulfide buildup in the biomat and soil to allow for better water absorption.

Learn more about Septic-Scrub at www.arcam.com.

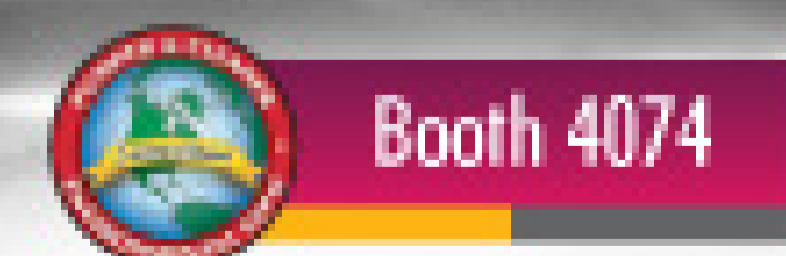
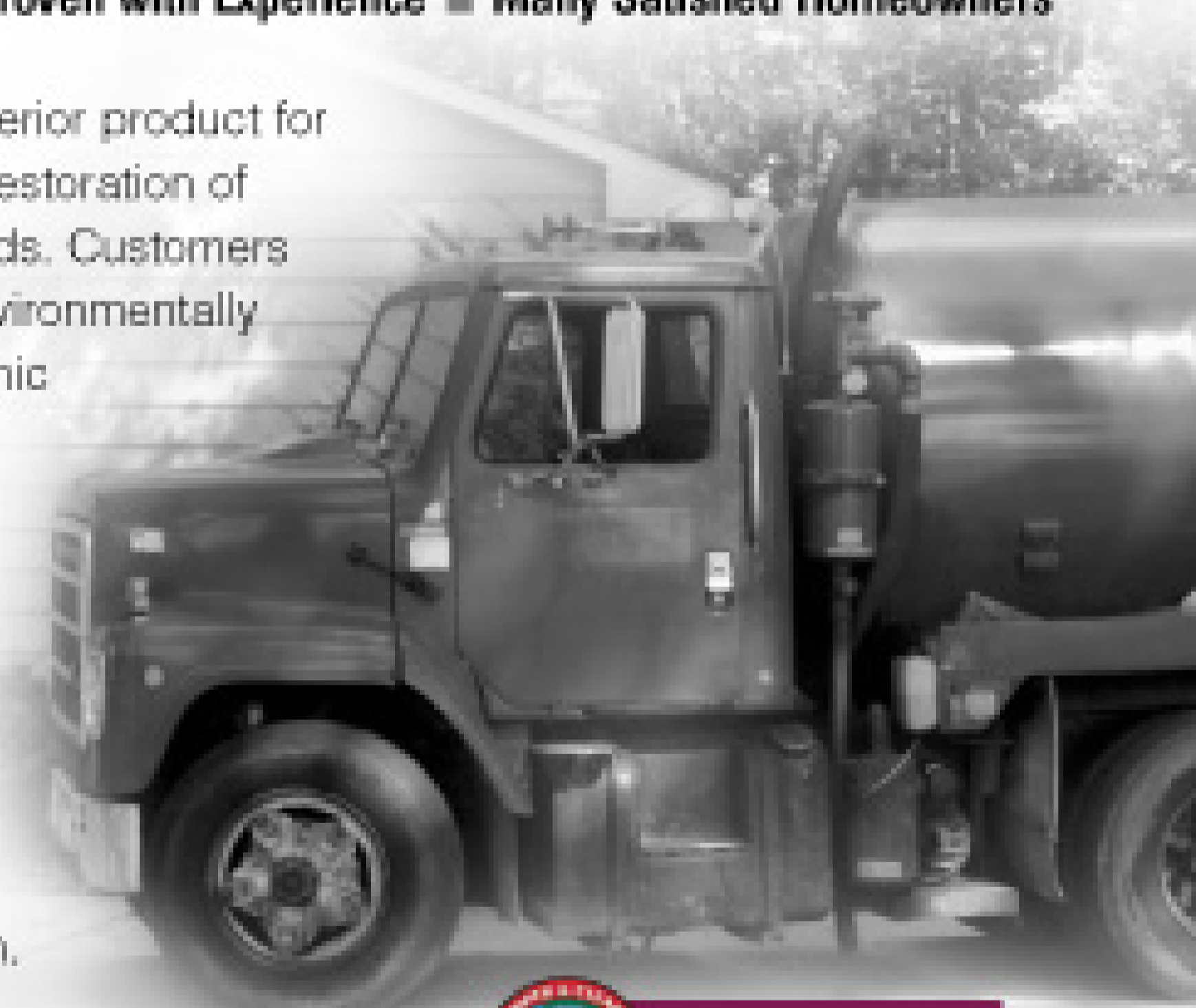

arcam

P.O. Box 65
 Scotch Plains, NJ 07076-0065

For information on increasing sales and providing a valuable service to your customers, call Arcan Enterprises at **888-35ARCAN (352-7226)**

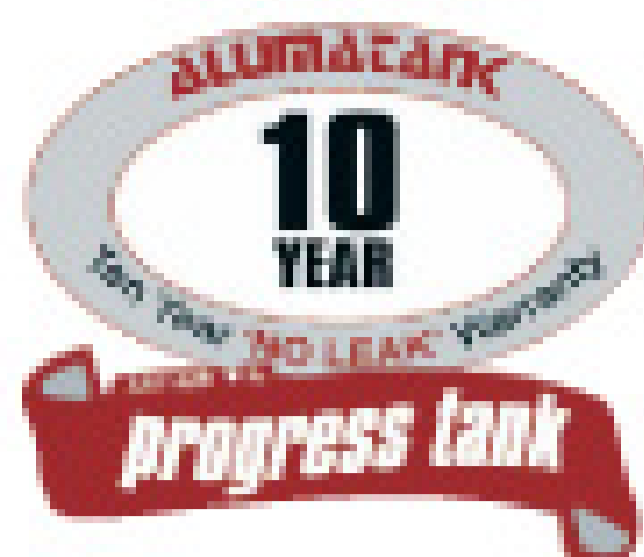

Toll-Free: 1-888-848-3727

LaVerne Charlet

email: lctanks@bellsouth.net / fax: 270-898-4055
175 Cascade Drive, Paducah, KY 42003

**LOUISVILLE
BOOTH 7141**

NEW! 2007 Peterbilt 340 Full Opening Rear Door with Tank Hoist

Cummins diesel, 10-Speed Trans.
3800 Gallon Aluminum
200 Water / 3600 Waste
Masport HXL400 Water Cooled
400 CFM Vacuum Pump
3000 PSI Jetter System
Tool Box

\$124,670 Plus FET
Lease from **\$1710.** mo.



PORTAVAC portable restroom service trucks

NEW! 2008 Mid Range Kenworth, Non-CDL Factory Built with a 10 Year Tank Warranty

2008 Kenworth T300 - 22,000 GVW

Cummins diesel, Allison automatic,
Hydraulic brakes, Air Conditioned, AM/FM
Air suspension drivers seat, R.H. electric window
Electric door locks, Turbo exhaust brake,

1700 Gallon PORTAVAC

400 fresh / 1300 waste Masport HXL 4 Vac pump
with pre-filter, Burks DC 10 wash down,
Hot shift PTO w/ remote 4" Discharge,
Unit hauler and tow package.



\$73,900 Lease from **\$940.** mo.



ALUMATANK

2007 LT9500 Sterling

MBEW 410/450 HP, 10 Speed transmission
58,000 GVW, 18,000 lb. / 40,000 lb. axles
4200 Gallon Septic Service

Masport 400CFM pump and tool box

\$129,000 Plus FET
from **\$2,570.** mo



Booth 7141

LCTANKS

800.334.8237

With King Vac technology, the most difficult jobs become easy.... without exception!



**KING
VAC**



Visit our island

Booth 14039

Louisville, KY

Just add an operator... and let the King Vac do the rest



*Visit our Website at www.keithhuber.com
or give us a call at Ph#1-800-334-8237*



The Clean Way to Go!

- Portable Toilets • Mobile Shower Units • Mobile Laundry Units •
- Septic Service • Mobile Restroom Units • Vacuum Trucks •
- Gray Water Removal • Potable Water Service • Holding Tanks •
- Generators • Tents • Catering • and much more...



Corporate Office:
250 Katherine Drive,
Flowood, MS 39232

601.709.0620
1.866.913.7186

Fax: 601.709.0622

www.gopottyllc.com

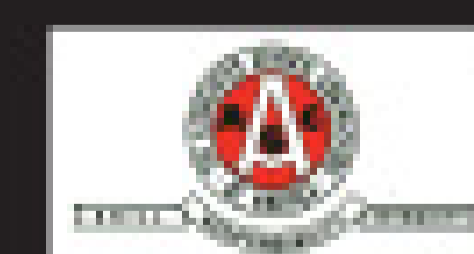

Booth 5189, 6189



48 YEARS OF DEPENDABILITY

TUFF-JON



Booth 106

- One-Piece Construction
- Lightweight
- Rust-Free Hardware
- Wood and Poly Skids
- Large Variety of Colors



Tanks in 60, 105, 225, 300 and 440 Gallon Sizes



90 Gallon Free-Standing Sink



60 Gallon Rinse Tank

— OPTIONAL ACCESSORIES —



7-1/2 Gallon Handwasher



Tuff Jon with Lifting Bracket Assembly



Urinal



Paper Dispenser



Sky Heater



Exceptionally Strong Tank Design

The TSF Company Inc. | 2930 S St. Phillips Rd. | Evansville, IN 47712

Toll Free: **1-800-843-9286** | **812-985-2630** | Fax: **812-985-3671**

E-mail: **tsftuffjon@sbcglobal.net** | Web Site: **www.tuff-jon.com**



PORTABLE TOILETS | CHEMICAL TOILETS | HOLDING TANKS | HAND WASH UNITS

The Original Yellow Handle



Bolted Poly Valves

- 2" & 3" full port valve
- FKM (viton type) seals
- Stainless steel bolts
- PTFE ball seats



Nozzle Valves

- Lightweight hose end valve for convenient transfer of liquids into drums, tanks, etc.
- Angled end flange with 8" long polypropylene fill spout.
- All stainless bolts.

Poly Cam Lever Couplings

- Glass filled poly for strength and durability.



TC Clamps

FEATURES

- Stainless steel construction.
- Stainless steel bolt with silver plated nut to prevent seizing.
- 360° sealing surface.
- Ideal for high torque applications.
- Strong, positive connections where ordinary hose clamps fail.
- Nylon lock nut feature.
- T-bolt design.
- 3 spot welds for extra strength.



Liquid System Products

www.banjocorp.com

150 Banjo Drive Crawfordsville, IN 47933 ph: 765-362-7367 fax: 800-458-0232 or 765-362-0744 sales1@banjocorp.com



URETHANE VACUUM AND DISCHARGE HOSE

Designed specifically for transfer of abrasive materials under vacuum. Lightweight and easy to handle. Translucent for visual flow monitoring. Leaf debris collection, sewage suction and discharge, street sweepers, sludge and slurries.

U.S.A. 1.800.225.0215
CANADA 905.666.4970

FAX 856.768.2385
FAX 905.666.9388

WEBSITE www.novaflex.com
EMAIL sales@novaflex.com

TRANSPORT TRUCK SALES, INC.

Ask for Scott or Frank – 888-395-7551
After hours call Scott at 816-590-4076



What Does It Take To Be A "Qualified Chassis"?

- ✓ Pass our 12 point checklist. (We send this out with every quote!)
- ✓ Pass a D.O.T. certified inspection!
- ✓ Pass the warranty inspection!

What Does All This Do For You?

- ✓ Nationwide drive train warranty for 2 years/ 200K miles! (restrictions apply)
- ✓ A tough truck that is ready to work as hard as you do!

YOUR TRADES ARE WELCOME!

**Searching For A Brand New Chassis?
 We Have Them In Stock!**



IN PROGRESS

1999 International 9200i, Detroit 12.7L 430HP, 10-spd, jakes, 291K miles, double framed, AC, new 3360 gal. steel tank, new liquid cooled HXL-400 Masport vac pump.

Call For Pricing!

2-YEAR 200,000 MILE DRIVE TRAIN WARRANTY



2001 Mack CL-713, E-7 460HP, 18spd, jakes, 20# fronts, 46# rears, double framed, new 3800 gal. steel tank, new liquid cooled HXL-400 Masport vac pump.

Call For Pricing!

2-YEAR 200,000 MILE DRIVE TRAIN WARRANTY



2002 Sterling AT-9513, Cat C-12 410HP, 10-spd, 350K miles, double framed, AC, new 3360 gal. steel tank, new liquid cooled HXL-400 Masport vac pump.

Call For Pricing!

2-YEAR 200,000 MILE DRIVE TRAIN WARRANTY



2002 International 9400i, Cat 475HP, 10spd, jakes, 14# fronts, 46# rears, double framed, new 3360 gal. steel tank, new liquid cooled HXL-400 Masport vac pump.

Call For Pricing!

2-YEAR 200,000 MILE DRIVE TRAIN WARRANTY



2002 International 9100i, Cat C-12 410HP, 10-spd, jakes, double framed, AC, new 3360 gal. steel tank, new liquid cooled HXL-400 Masport vac pump.

Call For Pricing!

2-YEAR 200,000 MILE DRIVE TRAIN WARRANTY



1999 Freightliner FL-70, Cummins 215HP, 6-spd., 33# GVW, air brakes, AC, low miles, new 2300 gal. steel tank, new Jurop vac pump.

Call For Pricing!

2-YEAR 100,000 MILE DRIVE TRAIN WARRANTY

Delivery Available Anywhere in the Lower 48!!



The Danbury Septic team (from left) includes Richard J., Carole, Richard II and Philip Chiarella.

Danbury, Conn.

Founders: Richard J. Chiarella and Philip E. Mazzucco

Owner: Richard J. Chiarella

Employees: 4

In the beginning: The founders started with a combined excavation and septic-pumping business in 1968, then split into two companies, with Chiarella taking the septic side. Chiarella met his future wife, Carole Mazzucco, then started pumping in 1963, working for Carole's father, Philip, who owned M & M Septic Tank. Carole's grandfather Anthony Di Tullio started D & S Septic years earlier.

Today: The Chiarellas have been joined in the business by their two sons, Richard II and Philip. The company pumps 50 percent residential and 50 percent commercial customers. Philip started a separate portable sanitation business, PJ's Porta Johns.

Fleet: Two septic service trucks, a 2007 Freightliner with a 2,500-gallon steel tank and Jurop pump from Amthor International and a 2002 International 4900 with a 2,500-gallon stainless steel tank from Transway Systems Inc.

Motto: "Service is our last name."

SHARE THE GOOD NEWS

If your company is reaching a 25-, 40- or 50-year anniversary, we'd like to hear about it. To spread the news of your company milestone, gather your crew in front of one of your vacuum trucks for a team photo. Send the photo to Pumper@ along with your anniversary information, a contact phone number and names of everyone in the photo. We'll run your photo and information in upcoming issues of *Pumper* as space allows. Digital images are preferred and better-quality photographs are more likely to be considered for publication. E-mail photos and information to editor@pumper.com, or send materials to COLE Publishing, P.O. 220, Three Lakes, Wis. 54562.

Your Source for Septic Inspection Equipment!

<p>CAMERAS, LOCATORS & TRANSMITTERS</p>	<p>SLUDGE JUDGE SAMPLERS</p> <p>SOIL PROBES</p>	<p>EXTEND-A-VUE™ INSPECTION MIRRORS</p> <ul style="list-style-type: none"> • Mirror Swivels 180° • Acrylic Mirror Resists Scratching & Breaking • Optional Light Kit <p>MINI MAX CONFINED SPACE GAS MONITOR</p> <p>Special Pricing, Call Today!</p> <ul style="list-style-type: none"> • Full 2-Year Warranty • Low Cost of Ownership 	<p>SWIVEL ADAPTERS</p> <p>360° Swivel Action!</p> <p>HOSE HOOK</p>	<p>WASTEWATER ANALYSIS</p> <ul style="list-style-type: none"> • Works out of the box • Easy Calibration <p>Dissolved Oxygen Meters</p> <p>Free & Total Chlorine Meter</p> <p>Direct Soil pH Meter</p> <p>Field pH Meter</p>	<p>RV ADAPTERS</p> <p>LEAK DETECTION</p> <p>Dye & Smoke</p>	<p>PH METERS</p> <ul style="list-style-type: none"> • Works out of the box • Easy Calibration • Temperature Compensation <p>SUREPOINT SEPTIC MARKERS</p> <ul style="list-style-type: none"> • Available with your Custom Message or Logo • Guaranteed Unbreakable
--	---	--	--	--	---	--

Booth 8069

RABCO
800-2-DRAINS

21 Crestway • Hamden, CT 06514
Ph (203) 230-1693 • (800) 237-2467
Fx (203) 230-2956 • (800) 535-3332
www.PumperSupply.com

IT'S SHOWTIME!

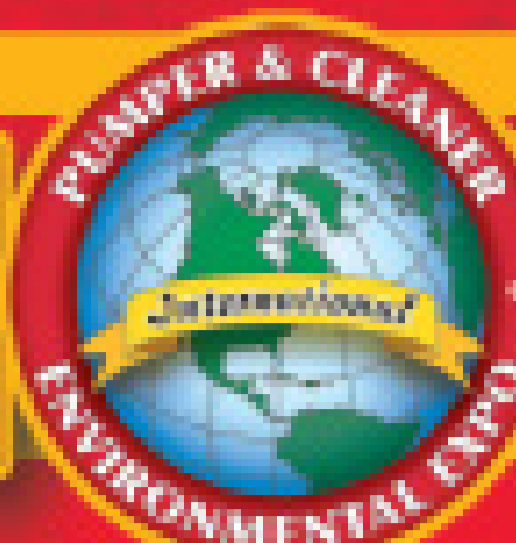

THANKS TO AGGIELAND SEPTIC SERVICE



THANKS TO WORK BOX SERVICES



THE ORIGINAL GEM JET IS STILL THE BEST. 2000 PSI @ 15 GMP

Financing Available



300 + 100 GALLON READY TO GO UNIT THAT WILL FIT IN THE BACK OF YOUR PICK-UP



THANKS TINGLE SEPTIC



THANKS BONNIE



IN STOCK FOR IMMEDIATE DELIVERY - 1100 + 450 PORTABLE TOILET TANK ON A KW CHASSIS. CALL FOR DETAILS.

WE HAVE STEEL TANKS IN STOCK READY TO BE MOUNTED ON YOUR TRUCK



Booth 3140

LELY MANUFACTURING

P.O. Box 789 • Wilson, NC 27893
252-291-7050 • FAX: 252-237-7726
E-mail: sales@lelyus.com

800-334-2763
John Minnis, Sales Representative
540-547-2463

www.lelyus.com



SERVING THE LIQUID WASTE INDUSTRY FOR OVER 50 YEARS

LELY WASTE SOLUTIONS

P.O. Box 1026 • Temple, TX 76503
254-938-2564 • FAX: 254-938-7204

800-367-5359
Bruce Curry • Earl Ballard
E-mail: bcurry@lelywaste.com

www.lelywaste.com



Booth 8149

When it's forty miles out and forty miles back, Pump failure is not an option.

When you need to trust your equipment, insist on NVE vacuum pumps.



Designed and built with the customer
in mind – resulting in dependable,
high performing pumps that are easy
to install, operate and service.

www.natvac.com

800-253-5500 - 2670 Aero Park Drive - Traverse City, MI 49686

NVE

Powerful. Performance.

CIRCLE D TRUCK SALES

www.circledtruck.com



VERY NICE!

2003 Freightliner FLD 120SD, 352K miles, C-12 CAT 410HP, Fuller 13 speed, Engine Brake, 4:11 ratio, Air ride suspension, 192" WB, 127" CT, Aluminum / Steel wheels, 11R22.5 tires, 1 x 130gl. fuel tank, Chrome bumper, Visor, Chrome exhaust, Power windows, High back seats, Cruise, AC, PS, AM/FM stereo, Very Nice. "NEW" 4000gl. 1/4" Aluminum DOT 407 / 412 Vacuum Tank, Full length hose trays, Side ladder, Roll-over protection, (2) internal baffles, (1) rear cleanout, (1) top manway, 4" rear outlet with butterfly valve, Rear hose brackets, rear work lights, Rear Float gauge, Secondary. Jurap R260 364CFM Pressure pump. + FET Stk. #2055. **Price: \$87,500**



12 IN STOCK NOW

(12) 2007 Troxell Vacuum Trailer, non-code, 130bbl. (5,460 Gallons), 4 Spring Suspension, Steel Composition, 24.5 Tires, All Steel Wheels, Tandem Axle, 1 Compartments, Full length walkway with Tool box, (2) 4" butterfly valves, scrubbers, Full length hose trays. Ready to haul!!! FET included in price, **\$43,1200**



NEW TANK

(2) **1998 MACK RB688S**, E-7 Mack 350 HP, 9 Speed, Engine Brake, Camelback Suspension, 4.64 Ratio, 190" WB, 24.5 Tires, Aluminum / Steel Wheels, Tandem Axle, 12,000# FA, 38,000# RA, HD frame, AM/FM Stereo, P/S, A/C, New Chrome Bumper, (2) 80 Gallon Aluminum Fuel Tanks, Detailed And Serviced, New White Paint. "NEW" 2007 Bulldog Vacuum Tanks, 3,360 Gallons (80bbl), 1/4" Head & Shell Thickness, Primary & Secondary Shutoff, (2) Top Man Ways, (1) Rear Clean Out, (2) Internal Baffles, Sump With (2) 4" Rear Outlets With Water Style Butterfly Valves, Front Sight Glass, Vacuum & Pressure Relief Valves, Full Length Hose Trays, Rear Bumper, Jurap R260 Vacuum / Pressure Pump With Pump Stand And Right Angle Drive. Stk. #1487 **\$74,500 each**



VERY NICE!

2001 MACK CX613 VISION, E7-427 Mack, 10 Speed Autoshift, Engine Brake, Air Ride Suspension, 3.70 Ratio, 220" WB, 22.5LP Tires, All Steel Wheels, Tandem Axle, 500-600K Miles, Tilt, Cruise, AM/FM Stereo, Fleet Maintained, (2) 145 gal Aluminum Fuel Tanks, "NEW" 2007 Bulldog Full Tilt Vacuum Tank Hydraulic driven, Controls on driver side, 3,360 Gallons (80bbl), 1/4" Head & Shell Thickness, Primary & Secondary Shutoff, (2) Top Man Ways, (1) Rear oversized Clean Out air operated, (2) Internal Baffles, Sump With (2) 4" Rear Outlets With Water Style Butterfly Valves, Front Sight Glass, Vacuum & Pressure Relief Valves, Full Length Hose Trays, Rear Bumper, Jurap R260 Vacuum / Pressure Pump Hydraulic driven fan cooled. **Stk #1790 \$89,500**

Available Soon: 1992 Volvo w/Vactor unit, good spec's, being refurbished - Call for price!

**MORE TRUCKS AND TRAILERS AVAILABLE,
IF WE DON'T HAVE IT WE'LL FIND IT!**
Lee Dill, Richard Roberts, John Trammell, Gary Chandler
CIRCLE D. TRUCK SALES

4502 E. OVERLAND TRAIL • ABILENE, TX • 79601
325-677-0474 • FAX: 325-673-7207

888-433-0474



4 IN STOCK

2005 MACK VISION CX613 "NEW" Presvac DOT-MC MC 412, 3150 Gallon, Tilt With Full Open Rear Head, 4" Lead Line With Riser, 6" Discharge, Catwalk With Handrails, Fruitland RCF 500 Vacuum Pump, Tilt, Cruise, AM/FM, Fleet Maintained, (2) Alum Fuel Tanks **\$135,000**

2008 Pumper & Cleaner Expo Floorplan

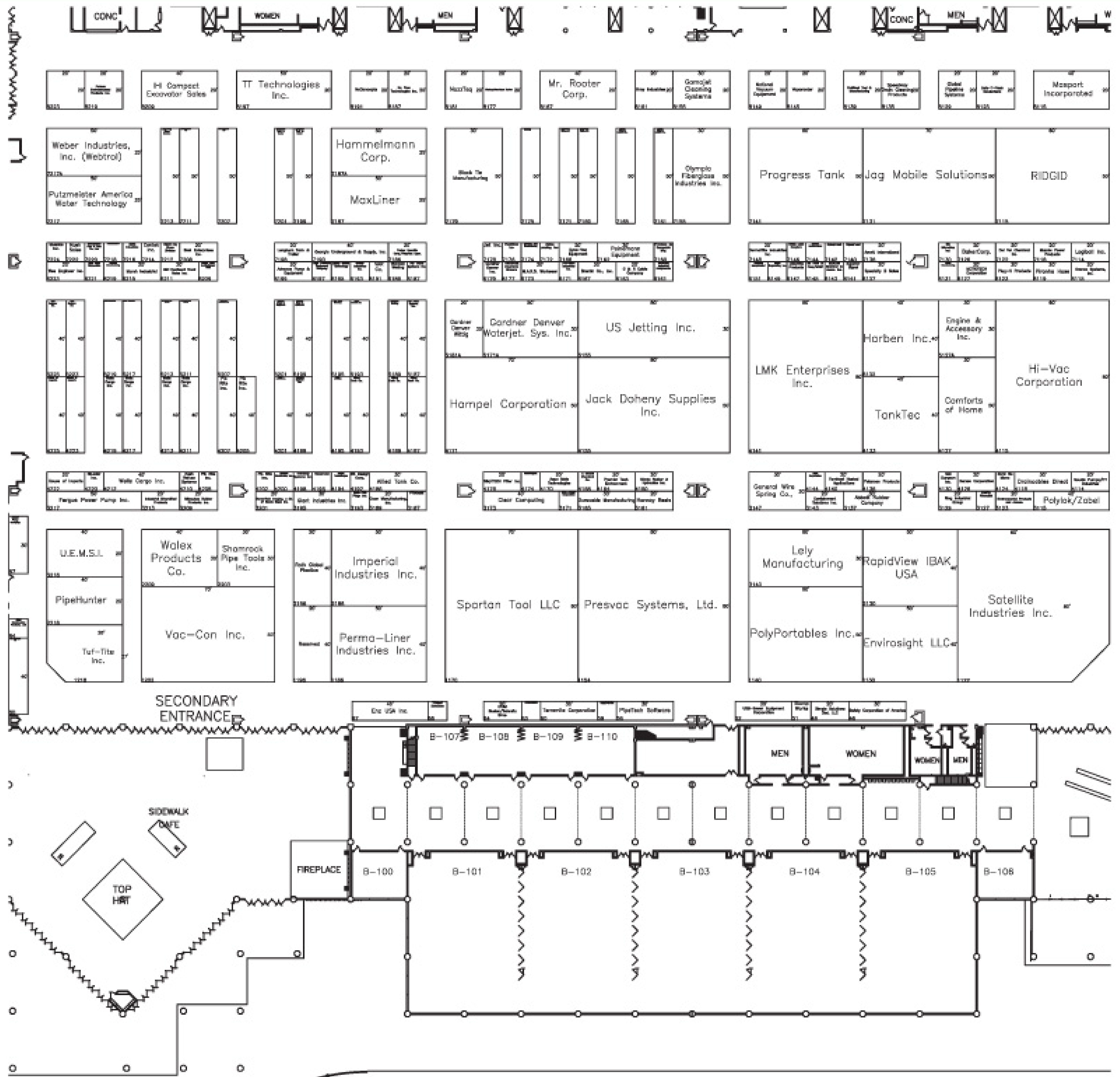

South Wing

FEBRUARY 27-29, MARCH 1, 2008

KENTUCKY EXPOSITION CENTER • LOUISVILLE, KY

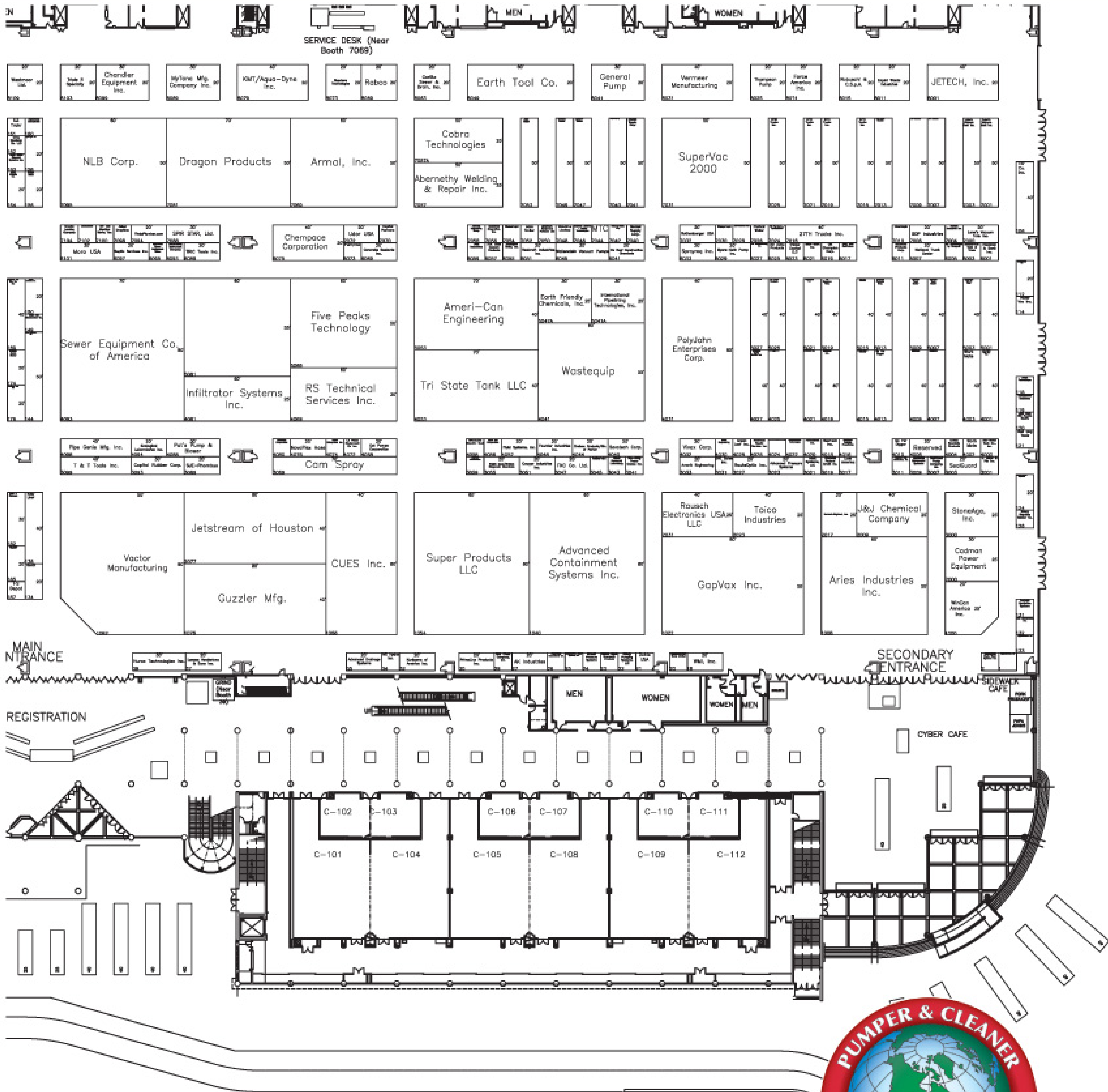

FLOORPLAN CURRENT AS OF 1-18-08. SUBJECT TO CHANGE WITHOUT NOTICE.





FEBRUARY 27-29, MARCH 1, 2008

KENTUCKY EXPOSITION CENTER • LOUISVILLE, KY

2008 Exhibitor List

List is current as of 1-18-08.
List is subject to change without notice.

Company Name	Booth Number
1st Global	21011
27TH Trucks Inc.	7015 - 7019, 7021, 7025
3T Equipment Co., Inc.	21021
A & L Systems, Inc.	10043
A Corp/Rooter-Man	9015, 9115
A Global Chemical Co.	4168
A.R. North America, Inc.	19025
A.W. Cook Cement Products	6057
Abbott Rubber Company	3137
Abnornthy Welding & Repair Inc.	7057
Accent Manufacturing	14014, 14015
ACE DuraFlo Systems	13017
Acro Trailer	7052, 7053
Adler Tank Rentals	18035
Advance Pump & Equipment	5199, 5201, 6199
Advanced Containment Systems Inc.	1040
Advanced Drainage Systems	14057
Advanced Infrastructure	3059
Advanced Pressure Systems	3023
Advanced Tank Systems, Inc.	14028, 14029
Advanced Wastewater Systems	3009
AerriTech, LLC	21000
AGCO-Ag Chem Division	7212, 7213
AK Industries	27
All Star Equipment Sales, Inc.	13061
Allan J. Coleman	182
AllGreen Manufacturing, LLC	20037
Allied Construction Products, LLC	84
Allied Graphics	7098
Allied Tank Co.	4186, 4187, 4189, 4193
Almetek Industries	17049
Alpha Mobile Solutions	11060, 11061, 11063
Alpine Leasing, Inc.	7172
AltamaMats	7102
Ameri-Can Engineering	5053
American Industrial Components	6161
American Leak Detection	7030
American Liquid Waste Magazine	19030
Amerik Engineering	3033
ANC Marketing, LLC	19019
AP/M Permalarm	19023
Aqua Ben Corporation	4056
Aqua Blast Corporation	6221
Aqua Mole Technologies	4170
Aqua-Zyme Disposal Systems Inc.	163
Arcan Enterprises Inc.	4074
Aries Industries Inc.	1008
Armal, Inc.	7069
Arthur Products	9109
Ashland Trap Distribution, Co.	3011
Ashthead Technology Rentals	9208
Atlanta Rubber & Hydraulics Inc.	4160
Avanti International	7136
B & W Mantrad, Inc.	16028, 17029
Bad Dog Teals	121
Badger Truck Center/Badger WCS	5207, 6209
Baker Waste Equipment	10063
BakerCorp.	7126
Bandlock Corporation	4080
Banjo Corp.	19014
BASE Engineering	4030
BDP Industries	7006, 7007, 7009
Benjamin Franklin Franchising	4015, 4016
Best Enterprises Inc.	7207, 7208, 7211
Betts Industries	7216
Big Fish Environmental, LLC	20029
BigEasyLift	18024
Bio Clean	9141

Company Name	Booth Number
Bio Microbics Inc.	7130
Black Tie Manufacturing	7179
Blue Angel Pumps	19026
Boatman Industries	20024
Bord No More	4124
Bosserman Tank & Truck	5003, 6003
Bowman Tool Co.	9320
Breslin Co., Inc.	6167
Bright Dyes/Division Kingscote Chemicals	3055
Bright Technologies	4194, 4195
BS Design Corp.	4192
Butech Pressure Systems	24
BW Technologies by Honeywell	6005
Cadman Power Equipment	2000
CAG Truck Capital	9137
Cam Spray	3069
Can Clay	20027
Canplas Industries, Ltd.	20038
Cape Cod Biochemical Co.	149
Capital Partners	7070
Capital Rubber Corp.	3093
Cat Pumps Corporation	4068
CCI Spectrum / SpectraShield	7024
Center Capital Corporation	185
Century Chemical Corporation	124
Certal International	18039
Champion Pump Company, Inc.	3007
Chandler Equipment Inc.	8099
Chelsea Products/Div. of Parker	4044
Chem Tech Products	7140
Chempore Corporation	6075
Chempure Products Corp.	9332
ChemStation International	14032
Chem Industries Inc.	150
CIPP Services	11042, 11043
City Motor, Inc.	20014
Clear Computing	3173
Clearstream Waste Water Systems Inc.	2
Cloverleaf Tool Co.	176
Cobra Technologies	7057A
COLE Publishing, Inc.	45
Comforts of Home	4127
Community Leasing Associates	9322
Compliance Solutions	119
Concertic Enviro, Inc.	18030
Concept Engineering Group	7058
Concrete Sealants Inc.	6069
Consolidated Pipe & Tube Co., Inc.	7220
Consolidated Treatment	9306
Containment Solutions Inc.	3143
Corlok Inc.	7214
Coon Manufacturing, Inc.	3189
Cougar Industries Inc.	3051
Cooreals	7010
Crescent Tank Manufacturing	7174, 7175
Cretex Specialty Products	4004
Crust Buster/Schmitz Bros.	64
CUES Inc.	1068
CuraFlo	17037
Custom Biologicals Inc.	7004
Cylogis Electronics, Inc.	4200, 4201
Dahle USA	21
Data Works Solutions	13029
Da Neel Construction Chemicals	6041
Deal Associates	6059
DekoRra Products	6147
Del Val Chemical Co.	7122
Del Zotto Products	5025, 6025

Company Name	Booth Number
Delta Environmental	21002
DermaLite Industries Inc.	7148
Ditch Witch	10039
Domestic Sanitation Systems	131
Doug Meadows Co. LLC	162
Dragon Products	7081
Drainables Direct	4118
Dresser Roots Blower	174
DrepBox Inc.	9009
Dultmeier Sales	18036
Durable Manufacturing	3165
Durand-Wayland, Inc.	2017
Dyna-Vac Equipment	7168, 7169, 7171
E.H. Wach Company	16014, 17015
Earth Friendly Chemicals, Inc.	5041A
Earth Tool Co.	8049
Easy Liner	136, 9037
Ecological Laboratories Inc.	4004
Ecological Tanks, Inc.	6055
Elastec/American Marine	8177
Electric Eel Mfg. Co. Inc.	169
Eljen Corporation	4144
Engine & Accessory Inc.	5127A
Environmental Products and Access.	3123
Environmental Technologies	4022
EnviroSight LLC	1130
Enz USA Inc.	67
Evergreen Tank Solutions	10051
EVH Supply	16007
Explorer Trailers - McKee Technologies	7046, 7047
EZ Trakr	161
Fabco Automotive Corp.	18018
Famhost Hosted Applications	4140
Federal Signal Emergency Products	23
Fergus Power Pump Inc.	3217
Fibax, Inc.	9209
Financial Federal Credit Inc.	3019
FindaPlumber.com	7094
Fisher Research Laboratory	3043
Five Peaks Technology	5069
FRC Co. Ltd.	3047
FleetBess Inc.	7176
Flo Trend Systems Inc.	5187, 6187
Fluid Systems, Inc.	4052
FM Manufacturing Inc.	5027, 6027
FMC Technologies	9235
FMA Group	14003
Force America Inc.	8021
Formadrain Inc.	4020, 4021
Fort Bend Services, Inc.	17031
Fournier Industries Inc.	4048
Franklin Miller, Inc.	20030
Frontier Technology, Inc.	19029
Fruitland Tool & Manufacturing	8139
PS Depot	187
G & R Cable Company	6163
Gallup Agitator Systems, Inc.	16016, 17017
GamaJet Cleaning Systems	8155
GapMax Inc.	1022
Gardner Denver Inc.	6179
Gardner Denver Waterjet Sys. Inc.	5171A
Gardner Denver Wittig	5181A
General Pump	8041
General Wire Spring Co.,	3147
Geoflow, Inc.	19035
GeoNav Group International	19039
Georgia Underground & Supply, Inc.	7190
Giant Industries Inc.	3195

Company Name	Booth Number
Global Pipeline Systems	8129
Global Tank Leasing	18021
Go For Digger	4010, 4013
Go Potty, LLC	5189, 6189
Godwin Pumps of America Inc.	9029
Goldak Inc.	9223
Garlitz Sewer & Drain, Inc.	8063
Gaulds Pumps/ITT Industries	4114
Granite Leasing Company	7104
Great Lakes Bio Systems, Inc.	13033
Green Leaf Inc.	4028
Gulf Atlantic Pump & Dredge	19018
Guzzler Mfg.	1076
H & M Vacuum Pumps & Equip.	9117
Hadney-Division Svc	5001, 6001
Hammelmann Corp.	7187A
Hampel Corporation	4171
Hannay Reels	3161
Happy Feet	21025
Harbon Inc.	6132
Hart Industries	9221
Hauleragent	4174
Hedstrom Plastics	9206
Heffernan Insurance Brokers	6177
Heintzmann Corp.	10045
Hibon, Inc./Div. of Ingersoll Rand	9216
High Pressure Equipment Company	6197
Highland Tank & Manufacturing	17033
Hi-Vac Corporation	4115
Host Systems, LLC	3021
House of Imports	4222, 4223, 4225
HPP Sol	18037
Hur Chemical Manufacturing	9211
Hurco Technologies Inc.	39
Hydra Engineering Inc.	6149
Hypro	14030
I.B. Moore Company	9139
IFM, Inc.	10047
IHI Compact Excavator Sales	8209
Imperial Industries Inc.	2186
Industrial Diversified Products	3213
Industrial Fabrics	16020, 17019
Industrial Magnetics, Inc.	7056
Infiltrator Systems Inc.	4081
Inflow Solutions, Inc.	14016, 14017
Infrastructure Repair Systems, Inc.	25
Infratech	13035
Insight Vision	156
ISCO Industries, LLC	14052
ITT Flygt Corporation	9232
IVS Hydro Inc.	34
J&J Chemical Company	2009
J. Heule & Fils Inc.	3001
J.C. Gury Company, Inc.	20043
Jack Deheny Supplies Inc.	4155
Jag Mobile Solutions	7131
Jet Inc.	7178
JETECH, Inc.	8001
Jetstream of Houston	2077
JGB Enterprises, Inc.	152
Juggler by Labrie	9017
KeelVac Industries Inc.	9003
KEG Technologies Inc.	80
Keith Huber, Inc.	14039
Kentucky Tank, Inc.	13059
Kernco, Inc.	18025
Key Equipment Finance	11046
KMT/Aqua-Dyne Inc.	8079

Louisville 2008

MAKE YOUR MOVE

Company Name	Booth Number	Company Name	Booth Number	Company Name	Booth Number	Company Name	Booth Number
Knight Treatment Systems, Inc.	20031	Olympia Fiberglass Industries Inc.	7155, 7161, 7165	Ring Industrial Group	3129	Sarco Products Inc.	164
Kroy Industries	8161	OMI Industries	18038	Ring O-Matic, Mfg.	7042, 7043	SVE Sales Inc.	3031
Kuriyama of America Inc.	32	OMSI Transmissions Inc.	13037	Ritam Technologies	118	T & T Tools Inc.	3099
Kwik-Lok Couplers	7146	One Biotechnology	3045	Robinson Septic Service Inc.	4026, 4027	TankTec	4133
L.M.T. Inc.	13055	Onsite Water Treatment Magazine	18062	RebaProba Technologies, Inc.	17039	TCF Equipment Finance	19034
La Place Equipment Co. Inc.	4072	Ontario Hose	10061	Rebuschi USA, Inc.	8015	Terramite Corporation	60
Lane's Vacuum Tank Inc.	7000, 7001, 7003	Oreco Systems, Inc.	6115	Rocket Supply Corp.	7040, 7041	The Blast Bag Company, Inc.	21001
Lansas Vanderlans & Sons Inc.	37	Pacific Natural Energy Corp.	7054	Rodman & Co., Inc.	19022	The Bosworth Company	10055
Leaders Resource Network	20009	Parker Hannifin Corp./PolyFlex Oper.	7186	Roebic Laboratories, Inc.	9233	The Mattei Companies	18032
LEAF Financial Corporation	19036	Person Environmental Products Inc.	8219	Roex	134	The Service Program	21016
Loly Manufacturing	3140	Patent7000 BV	14007	Roth Global Plastics	2196	The Strong Company	9229
Lenzyme Incorporated	6151	Pat's Pump & Blower	4088	Rotherberger USA	7032	Thompson Pump	8025
Loon's Mfg. Company, Inc.	9334	PC Scale, Inc.	30	Roto-Rooter Corporation	3171	Toico Industries	2023
Liberty Financial	3127	Peerpoint Inc.	1196	RotoSolutions	63	Topp Industries, Inc.	20026
Liberty Pumps	9215	Peinemann Equipment	7162	RouteOptix Inc.	3027	Tracker Solutions	66
Link Manufacturing/Freedom Dodge	4024, 4025	Penny Packets	9324	RS Technical Services Inc.	4069	Transway Systems Inc.	4198, 4199
Liquid Waste Industries	7013, 8011	Pentair Water	7026	Rush Refuse Systems	4210	Tri State Tank LLC	4053
Liquid Waste Technology	5195, 6195	Perma-Liner Industries Inc.	1186	Rush Sales	7222	TRIC Tools Inc.	6089
Little Giant DBA Franklin Electric	120	Petersen Products	4136	Safe-T-Fresh Deodorizers	8125	Triple R Specialty	8103
LMR Enterprises Inc.	4141	Philadelphia Fry-a-Diesel	10059	Safety Corporation of America	46	Tristar Capital LLC	6023
Lock America	3017	Phoenix Industries & Apparatus, Inc.	14023, 14024	Safety Pumping Systems, LLC	22	Triton Services, Inc.	13025
Logiball Inc.	7114	PHOENIX Process Equipment	18034	Safety Vision	11058	TRY TEK Machine Works, Inc.	7100
Longhorn Tank & Trailer	7198, 7199, 7201	Pik Rite Inc.	4202, 4205, 4207, 4208	Salcor Incorporated	13063	TSF Co. Inc.	106
M.A.R.S. Workwear	6173	Pinnacle Manufacturing	21005	Salem Republic Rubber Co.	126	TT Technologies Inc.	8197
Madewell Products Corp.	5013, 6011	Pipe Genie Mfg. Inc.	4098	Satellite Industries Inc.	1122	Tuf-Tite Inc.	1218
Marsh Industrial	5217, 6215	PipeHunter	2218	Sauverson, Inc.	10057	U.E.M.S.I.	3218
Maspert Incorporated	8115	PipeLogix Inc.	158	Savatech Corp.	4040	Uder USA	7072
MaxLiner	7187	PipeTech Software	56	Schensted Instrument Company	6093	Under Pressure Systems, Inc.	19032
Mesa Waste Services	18029	Piranha Hose	6119	Screen Graphics of Florida, Inc.	4196	URACA/Chemac Inc.	112
METROTECH Corporation	6127	Plug-It Products	6123	ScreenTech Imaging/div. of Boeda Signs Inc.	3201	US Jetting Inc.	5155
Micro Target Media	21003	Plumbers Success International	20022	SEACON Brantner & Assoc. Inc.	6143	USA BlueBook	13049
Micro Target Media Technologies	21004	Pollardwater.com	7218, 9338	SealGuard	3003	USB-Sewer Equipment Corporation	52
Mid-Continent Truck Sales Inc.	5211, 5213, 6211	Poly-Flow	19021	Sealing Systems Inc.	9318	USpipelines.com, LLC	1133
Mid State Tank Co., Inc.	4000, 4001	PolyJohn Enterprises Corp.	4031	Septic Products Inc.	9336	VacAll Industries	10027
Midwest Gas Instrument Service	7142	Poly-Klyn	18015	Septic Services Inc.	6097	Vac-Con Inc.	1202
Milwaukee Electric Tool	4058	Polylok/Zabel	3115	SeptiTech	9239	Vactor Manufacturing	1092
Milwaukee Rubber Products Inc.	3209	PolyPortables Inc.	1140	Sepronics	59	Vacutrex Limited	7048, 7049
Mission Rubber Co.	21006	Portable Sanitation Assoc. Int'l.	20011	Sewer Equipment Co. of America	4095	Vacuum Truck Rental	19038
Mi-T-M	35	Posey Hydro Solutions	18031	Sewer Equipment Sales & Supplies	9107	Vanair Manufacturing	6131
Mody Pumps Inc.	18023	Power Vac Inc.	114	Shamrock Pipe Tools Inc.	2203	Vaporoater	8145
Monarch Coin & Security, Inc.	9207	PowerTrack International Inc.	26	Sherwin Williams	18016	VAR Co.	6191
Mongoose Jetters	4093	Power-Mole	9203	SIM/TECH Filter Inc.	4176	Vermear Manufacturing	8031
Morcon, Inc.	19031	Premier Tech Environment	4164	Simple Solutions Dist. LLC	49	Vision Technology, Inc.	17003
Moro USA	6101	Presvac Systems, Ltd.	1154	SJE-Rhombus	3089	Vivax Corp.	4032
Mosmatic Corporation	18014	Prime Resins, Inc.	9219	SludgeHammer Group Limited	20	Walex Products Co.	2209
Mr. Marshall	15007	Prime Solution, Inc.	9103	Smithco Manufacturing	5219, 6219	Wallenstein Vacuum Pumps	6045
Mr. Rooter Corp.	8167	ProClean by Durable Mfg.	7160	Snyder Industries	9129	Warren Environmental	18019
MTC	7044	Progress Tank	7141	SOFAB	18033	Wastequip	4041
Muncie Power Products	7118	ProSept Protection Plan	10053	Soil Surgeon Inc.	4130	Water Environment Federation	20017
Myers-Aplex/Pentair Water	7028	Pro-Tech Industries Inc.	6171	Southern Sewer Equipment Sales	6095	Water Jet Technology Association	20013
Myers-Sath Pump Inc.	6029	Prototek	3187	Spartan Tool LLC	1170	Weber Industries, Inc. (Webtrol)	7217A
MyTano Mfg. Company Inc.	8089	PT Coupling Company	18026	Specialty B Sales	6137	Wes Engineer Inc.	5223, 5225, 6223
NASSCO	20019	PumpBiz	17035	Spectrum Equipment Partners Ltd.	7050	Wells Fargo Inc.	4211 - 4213, 4217, 4219
National Precast Concrete Association	20015	PumpTec	6073	Speedway Drain Cleaning Products	8135	Wells Fargo Equipment Finance, Inc.	13031
National Truck Center	5007, 5009, 6007	Putzmeister America Water Technology	7217	SPG Tanks, Inc.	16022, 16026, 17025	Western Mole Cranes	20039
National Vacuum Equipment	8149	Qualex Inc.	9241	SPR STAR, Ltd.	7088	West-Mark Inc.	5021, 6021
NAWT Inc.	20003	Quality Service Contractors	14062	Sprayrog Inc.	6033	Westmoor Ltd.	8109
NewTech Inc.	4018, 4019	Quality Tank Trucks & Equipment	4006, 4007, 4009	SRECO-FLEXIBLE, Inc.	10007	White River Distributors	5015, 6017
Nexstar	9236	Quatics Inc.	7224	Stahly Truck Applicators	14048	Wilco Supply	9310
NILoader Inc.	4220	Rabco	8069	Stamp Works	51	Wil-Loc Inc.	13015
NLB Corp.	7095	Rainbow Pumping Systems	13019	Stellar Industries Inc.	5193, 6193	WinCan America Inc.	1000
No Flow In Flow/WCSP	6145	RAMEX SRL	20034	Stephans Technologies	8073	WMI, Inc.	18
Norwesco	12035	RapidView IBAK USA	2130	Sto-Away Power Cranes Inc.	3041	Wolf Creek Company, Inc.	29
NovaFlex Hose	4076	Ratech Electronics, Ltd.	144	StoneAge, Inc.	3000	WolfCreek Jetting & Mfg., Inc.	10049
NOWRA	20023	Rausch Electronics USA LLC	2031	Stuart Tank	11044, 11045	Work Mate	4002, 4003
NozzTeq	8181	RC Industries Inc.	9133	Subsurface Instruments	160	Worldwide Organics	20033
NSF International	20007	Real-Tite Plugs Inc.	3193	Surbelt Rentals	14043	Xerox Corporation	4126
No-Flow Technologies Inc.	5081	Reed Manufacturing Co.	19033	Sunrise Environmental	7144	Zeller Pump Company	87
NuConcepts	8191	Reelcraft Industries Inc.	6051	Super Products LLC	1054		
OCTMI	19017	Reline America Inc.	13003	Superior Signal Company	6141		
OK Champion Corp.	5019, 6019	RIGID	7115	Superior 2000	7031		

SUCCESS COMES IN



TUFWAY



TAURUS

NO MATTER WHAT YOUR
OPERATION REQUIRES, WE
HAVE YOUR SUCCESS IN MIND.



SEE US AT THE SHOW
IN LOUISVILLE, KY

BOOTH 1122

Whether your business caters to construction, recreation, or special events, the Satellite/Synergy family of portable restrooms has you covered. From the dependable and economical Tufway to the most sophisticated flushing restroom in the industry, the High Tech II Deluxe Flush, we've taken the guesswork out of success. We can help you choose the right solution for the job – for a single unit or an entire fleet.

► Contact your area manager to discover what we have in mind for your success.

ALL SHAPES & SIZES.



MAXIM 3000



HIGH TECH II

CONTACT YOUR AREA MANAGER AT:

1 (800) 328-3332

VISIT US ON THE WEB AT:

SatelliteIndustries.com | PortableToilet.net



SYNERGY WORLD



PARTNERSHIPS MADE FOR SUCCESS

WHEN YOU REALLY NEED A WORK TRUCK NOW!

1-800-822-8785

www.fssolutionsgroup.com



1997 Guzzler CL, 18" Vacuum, Ford L9000 Chassis, Refurbished with new paint
READY TO WORK!



1998 Guzzler CF ACE, 27" Vacuum, International Chassis, CY-Crane, Refurbished with new paint
READY TO WORK!



2006 Vactor 2112, Dual Stage Fan, 80 GPM @ 2500 PSI
TOO MANY OPTIONS TO LIST!

Many More Units Available • Call for Details!

Parts and Service
Financing for Used Equipment and Service
Warranties for Most Equipment
We Sell and Service
The Largest Selection of Refurbished
Vacuum Trucks in the World



Pipeline Cleaning & Maintenance Equipment



for



JETTERS & JET VACS

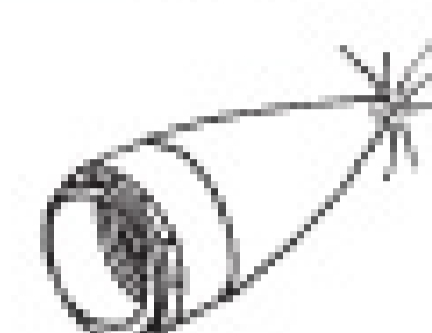

Penetrators

- 1/4"-15°\$31.00
- 3/8"-15°\$36.00
- 1/2"-25°\$41.00
- 1/2"-25°LT\$44.00
- 3/4"-12°\$48.00
- 3/4"-12°LT\$56.00
- 1"-12°\$61.00
- 1"-12°LT\$72.00



Aluminum Grease

3/4" or 1"-17° ...\$105.00

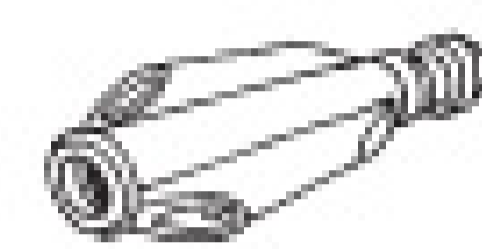

Truder

1"\$315.00

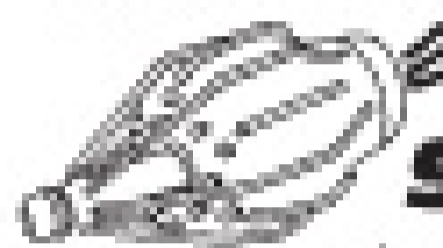

Shark

1"\$435.00
1" Big Shark.....\$555.00



Radial Bullet

- 1/4"-30° or 40°\$18.75
- 3/8"-30° or 40°\$21.75
- 3/4"-18° or 35°\$44.00
- 3/4"-18°/24°\$46.00
- 1"-18° or 30°\$59.00
- 1"-15° or 30°\$55.00
- 1-1/4"-18 or 35°.....\$85.00



Aluminum Sand

- 3/4"-24°\$125.00
- 1"-17°/24°\$138.00
- 1"-24°\$125.00

Stainless Steel Nozzles

- 1/8"\$26.00
- 1/4"\$28.00
- 3/8"\$34.00
- 1/2"\$48.00
- 3/4"\$52.00
- 1"\$92.00

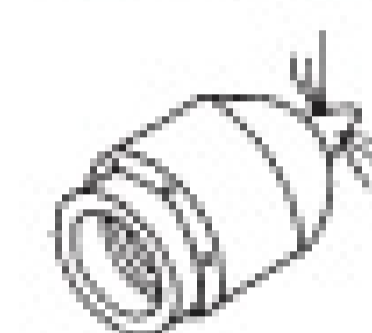

Steel Sand

1"-12°\$59.00

NEW Storm/Culvert Floor Cleaner Nozzles

MANY OTHER STYLES, SHAPES & SIZES AVAILABLE



Sewer Hose Guides

TigerTail™ Style

- 3" x 36"\$42.00
 - 2" x 36"\$34.00
- with 24' rope

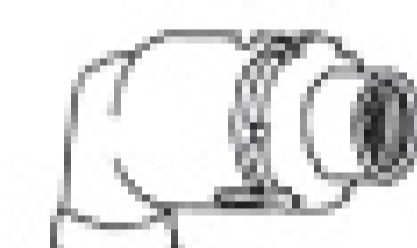

Swivel Joints

T-M® Style

- 90° or Straight, 6000 psi
- 3/4" & 1"\$169.00
- 1-1/4"\$174.00
- 1-1/2"\$432.00
- 2"\$547.00

Root Cutter Assemblies

- Skid Mounted**
 - w/flat blades\$815.00
 - w/concave blades\$850.00
 - w/spiral blades\$850.00
 - Donut Mounted**
 - w/flat blades\$790.00
 - w/concave blades\$835.00
 - w/spiral blades\$835.00
 - Lateral Mounted**
 - w/flat blades\$762.00
 - w/concave blades\$825.00
- Assemblies come with one ea. of 6, 8, 10 and 12" blades, saw blades, hub, skids, etc.



Clamps

- Power Clamps**
- 8"\$11.00
- 3"-6" available
- King Clamps**
- 8"\$24.00
- 4"-6" available
- Bandlock® Clamps**
- 8"\$18.00
- 3"-6" available
- Quick Clamps**
- 8"\$21.00
- 3"-6" available



Saw Blades

4"-18"

NEW Chain Root Cutters

4"-48", All Stainless Steel, No Lubrication

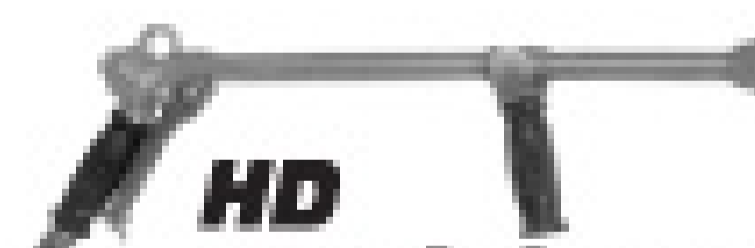

HD Washdown Gun

25 gpm @ 850 psi
1/2" Inlet\$140.00

Parker & Piranha Jetter Hose

1/8"-1-1/4"



Booth 176

Pipe/Sewer Plugs • Hose Reels • Aluminum Intake Tubes
Kanaflex™/Rubber Debris Hose • Full Line Of Warthog Nozzles



Toll Free: 800-365-6583
www.cloverleaftool.com

Full Catalog Online with Prices

SARASOTA, FLORIDA • PHONE: 941-739-0707 • FAX: 941-739-0001



CALL FOR OUR COMPLETE CATALOG WITH PRICES

THE BEST!

Art Blaster

Biodegradable Graffiti Remover

ART BLASTER ---

Takes off paint, pen, crayon, tar, soap scum, grease, calcium buildup and many more substances from Portable Toilets.

ART BLASTER ---

Leaves behind a *protective sheen* that prevents new offensive graffiti—even pencil wipes off!

ART BLASTER ---

Environmentally and user friendly. Created to work hard so you don't have to.



Call our customer service team for more details.

1-800-345-3303
www.jjchem.com



Booth 2009



Prodding Deadbeats

Consider your options when faced with a 'tough customer' who seems completely unwilling to pay

By Erik Gunn

It happens to every business at one time or another. You've completed the service and sent bill after bill after bill. And the customer just won't pay.

At this point, it may be tempting to try all sorts of responses. Pumpers have threatened to return the sludge to the deadbeat customer's tank. Such an outlandish action might sound satisfying, but it's best not to follow through with the threat for a number of good reasons.

You have little choice but to take the high road — and that doesn't mean giving up. You do have options when faced with a hard-case deadbeat. Here are some steps you can take.

1. Lay the groundwork in your business practices. Make sure the work you deliver is backed by a written agreement setting forth your terms and that the customer signs before you start. Find out what regulations your state imposes on such contracts and follow them. Include in the document specific provisions about when payment is due: upon completion, net 10 days, or whatever you choose. There is no need to give more than 30 days, and there is nothing wrong with requiring immediate payment.

Many businesses add a 1.5 percent per month finance charge to past-due accounts. If that's what you want to do, make sure it's permitted where you operate, then make sure your standard agreement and all your invoices include that information.

Because a service contract is a legal document, you're best off having a contract lawyer who knows your business draft your standard agreement. Your lawyer will help you decide whether it's a good idea to specify who pays attorneys' fees in a dispute and whether you want to go to arbitration rather than court.

"Get a form that works, and use it," says Steve Schuman, a lawyer in Beverly Hills, Calif., who represents contractors and other clients in dealing with past-due bills. "Otherwise, you go to sue somebody, even in small claims court, you might lose because you haven't followed the laws."

2. Accept credit cards. Plastic puts the customer's money in your account much faster than virtually anything but cash. That

alone is worth the service charges you will pay to the credit card company. And it's easier that way to tell customers they must pay on completion.

3. Bill promptly. If your policy allows customers to choose billing as a payment option, get the bills out as soon as you can. You don't have to wait and bill everyone at the end of the month. All that does is hurt your cash flow.

4. Make sure delinquent bills stand out for the customer. Print them on a different color of paper (such as red). Stamp them "past due" or program your invoicing software to print a past-due message.

5. Send a demand letter. When customers are late, ask firmly for payment. Many contractors have systems that automatically generate demand letters on a trigger date, such as 60 days past due. Be careful about how you word the letter. The text should be straightforward and should stick to the facts. Note the date of service, the outcome, the terms you quoted, and the total amount due.

Set a deadline. Explain without bluster or threats what you will do if payment is not made. For example: "Failure to pay the amount due by the stated deadline may require legal action or lead us to send this bill to a collection agency."

6. Hire a collection agency — but not to collect the bill, just to write letters. Some agencies will, for a flat fee, generate demand letters for you. Just getting a bill with the collection agency's name on the letterhead will jolt some slow payers into action.

Another alternative: Pay your lawyer to draft such a letter and send it out each time you have a delinquent customer. "You probably want to go to a transactional lawyer and get him to draft a standard contract and a standard collection letter," says Schuman. "You might in the first instance have to pay \$500 for that letter. Then you can use it for years. You might be able to pay just \$25 to \$50 to have the lawyer send it each time."

7. Go to small claims court. The rules for small claims court differ from state to state, so make sure you know what applies where you live. The cap on how much you can sue for will vary, and states differ on whether

Erik Gunn is a magazine writer and editor in Racine, Wis., where he operates Great Lakes Editorial Services, consulting for businesses, non-profits, and individuals. Readers may direct inquiries to him by contacting this publication at 800/257-7222 or e-mailing editor@pumper.com



Some (collection) agencies will, for a flat fee, generate demand letters for you. Just getting a bill with the collection agency's name on the letterhead will jolt some slow payers into action.

you may use a lawyer.

But make sure going to court is worth the money. "This needs to be an economic proposition," says Schuman. "It will cost you a certain number of dollars to pay the legal fees. Add up all the things you're going to pay out of pocket, out of your time, to go after this. Then decide whether it's going to be worth it. If someone rips you off for \$100, don't spend \$500 getting revenge."

Remember, also: Winning in court is not the same as collecting. "Then you only have a judgment," says Schuman. "That doesn't mean you can collect. You still have to go out and find their assets. You want to be careful you don't spend more of your time and money than it's worth trying to collect a judgment."

8. Enforce a judgment with a mechanic's lien. With a written order from a judge, you can file a lien on property belonging to your debtor. Then you wait. You can only collect when it comes time for the debtor to sell or refinance the property. Liens are usually structured to generate a modest amount of interest, so as time passes your judgment should maintain its real dollar value.

9. Hire a collection agency to actually collect the bill. This is usually an alternative to going to court. The drawback of using an agency is that you'll only get a portion of the amount due — usually half of what the agency gets. But this measure allows you to get that old account out of the way and to move on.

Sometimes a contractor decides to sidestep the collection agency by offering a deep discount on the bad debt to encourage the customer to pay it off. You'll have to decide whether that approach makes sense for you.

Throughout the collection process, keep your cool and stay professional. Let the delinquent customer know what legal recourses you have and will take, but don't resort to threats or harassment. ■

HOUSE OF IMPORTS **TRUCK SALES**

▶▶ SINCE 1947

CALL ANGEL AT:
786.258.3384
OR
305.691.4778

▶▶▶ WWW.HOUSE-OF-IMPORTS.COM

EXTRA CLEAN USED TRUCKS WITH NEW TANKS!



SEE THESE TRUCKS AT THE PUMPER & CLEANER EXPO IN LOUISVILLE AT BOOTHS 4222,4223,4225

2004 PETERBILT 379
475 H.P. - COMING SOON

2005 PETERBILT 379
430 H.P. - COMING SOON

2004 PETERBILT 379
500 H.P. - COMING SOON

2000 KENWORTH
THANK YOU TO RALPH OF ORLANDO



BOOTHS
4222,4223,4225



2 - 2001 INTERNATIONALS
THANK YOU TO MR. TERMINE JR.

100,000 MILE LIMITED FACTORY WARRANTY

▶ DELIVERY ▶ EXPORT ▶ PUMP WARRANTY: 1 YEAR ▶ TANK WARRANTY: 5 YEARS

THESE PRICES WILL KEEP YOU WARM!

\$99 MAX SHIPPING - TO MOST AREAS

BRASS LEVER VALVES



3" \$112.95
4" \$169.95
6" \$299.95

ALUMINUM FEMALE X MALE REDUCER

3" X 2" \$17.85
4" X 3" \$26.52
6" X 4" \$45.95



100'S OF COUPLERS & REDUCERS!

HI-VAC SUCTION HOSE CPLD Mx F QUICK CONNECT

2" X 20' \$74.70
2" X 25' \$91.70
2" X 30' \$108.70
2" X 40' \$142.20



BRAIDED EPDM HOSE

3" ID CPLD LENGTHS M x F CAM & GROOVE

3" X 20' \$104.95
3" X 30' \$147.95
3" X 35' \$168.95

- Braided Reinforcement
- Abrasion Resistant
- Lighter weight

FABRIC BRAID MAKES IT STRONGER!

2" ~~\$89.95~~ **\$84.95**
3" ~~\$89.95~~ **\$84.95**
4" ~~\$119.95~~ **\$97.95**
BUY AND SAVE! BULK 100' ROLLS \$4.25

DUCK BILL NOZZLES



2" ~~\$89.95~~ **\$84.95**
3" ~~\$89.95~~ **\$84.95**
4" ~~\$119.95~~ **\$97.95**

EPDM SUCTION HOSE



3" X 20' \$96.25 **\$79.95**
3" X 25' \$115.75 **\$94.95**
3" X 30' \$134.95 **\$109.95**
3" X 33' \$146.95 **\$119.95**

VARCO FLEXI-JOINT

NO MORE BREAKING OFF AT THE TRUCK!



\$51.99



Booth 6191

T-LIFT
\$99.95



PVC SANDY GRIP GLOVES
\$12.95 /DZ

BULK EPDM SUCTION HOSE LOW PRICES!

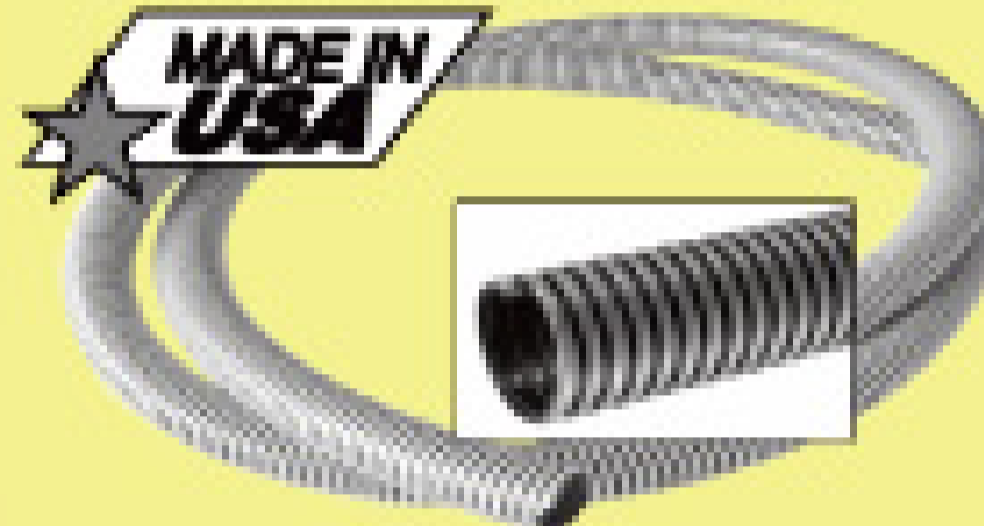

2"	3"	4"	6"
\$1.79	\$2.99	\$5.35	\$11.05
\$1.69	\$2.89	\$5.25	\$10.95

FREE CATALOG

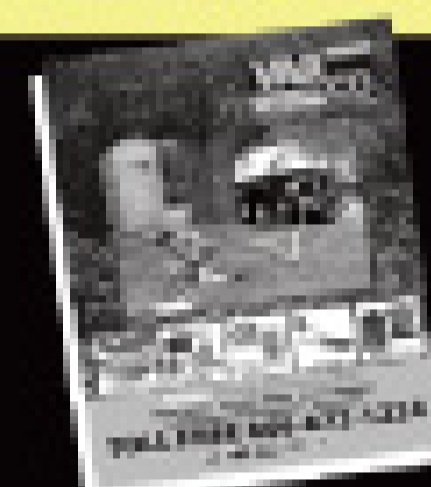

LOW, LOW PRICES - SAME DAY SHIPPING - FAMILY RUN!

TOLL FREE **866-872-1224**

SOURCE KEY
2P8



Closing Down Portable Restroom Business

"All Portable Restrooms, Trailers, Trucks"

Final Reduction Special Sale

STEVE REYNA

POB 457
WEST MEMPHIS, AR 72303

swreyna@msn.com

SEND EMAIL TO REQUEST PICTURES.

870-636-2243

Final Reduction
\$99,999.99

Basic Portable Restrooms
Event Quality\$185 Each
Basic Portable Restrooms
Construction Quality\$175 Each
Basic Portable Restrooms
With Sink\$250 Each

Signature Series (Custom)
Portable Restrooms\$374 Each
Sinks\$150 Each
Urinal Stations\$400 Each
Holding Tanks\$175 Each
Sewer Main Custom Portable
Restrooms\$400 Each
Children's Portable Restrooms \$200 Each

Toters 40 ft. 22 Units
(Price if Toilets Purchased)\$2,800 Each
Toters 20 ft. 10 Units
(Price if Toilets Purchased)\$1,800 Each

Truck Ford L8000 1900 Waste/
200 Fresh, 32,000 GVW\$12,000 Firm

Truck Flat Bed/Pumper/Tommy Lift/
500 Waste/150 Fresh\$20,000.00 Firm

Bonus If buy all equipment: All Supplies, Toilet Paper, Bag Soap, Doors, Sky Hooks, Chemical, Valves, Hoses, Parts and More..... FREE If You Purchase All Equipment.

Total Restrooms, Sinks, Urinal Stations, Holding Tanks, Sewer Main Units, Signature Units as listed above + 12 Barrels of Chemical as part of FREE bonus as stated above: 338 Units Total + Trucks & Trailers as of 1/18/2008

Steel Tanks



Polished Aluminum Skirting and Tool Boxes

- 2008 GMC 5500 Duramax, Diesel, Allison Automatic Transmission, 19,500 GVW, 1000 waste, 350 fresh\$59,000
- 2008 Ford, 6.4 Diesel, Automatic, 19,000 GVW, 950 waste, 300 fresh\$57,000
- 2008 Dodge 5500, Cummins Diesel, Aisin Automatic, 1000 waste, 300 fresh, 19,500.....Now Available
- 2007 Isuzu or W5500, Diesel, Automatic, 17,950 GVW, 750 waste, 300 fresh.....\$55,500

Aluminum Tanks



by Amthor 5/16" Thick

- 2008 GMC 5500 Duramax, Diesel, Allison Automatic, 19,500 GVW, 1000 waste, 400 Fresh\$67,500
- 2008 Ford, 6.4 Diesel, Automatic, 19,000 GVW, 1000 waste, 400 Fresh\$65,500
- 2008 Dodge 5500, Cummins Diesel, Aisin Automatic, 19,500 GVW, 1000 waste, 400 Fresh...Now Available
- 2007 International DT-466, Air Brakes, Automatic, Under CDL, 1500 waste, 500 Fresh\$80,500
- Any Brand Truck Available
- Used Septic and Toilet Trucks Available



Portable Restroom Trailers

Dodge Trucks Coming Soon Check Our Prices.

Booths 7000, 7001, 7003

8 RESTROOM | 10 RESTROOM | 12 RESTROOM | 14 RESTROOM | 16 RESTROOM | 20 RESTROOM

SLIDE-IN UNITS & USED TRUCKS AVAILABLE / MASPORT, JUROP & CONDE VACUUM PUMPS CHECK OUR PRICES

LANE'S VACUUM TANK, INC.
3133 VANZORA RD. • BENTON, KY 42025
800.592.3308 • 270.527.9945



We stand behind our trucks and trailers!

If the unit you're looking to buy lacks these features, you're looking at the wrong machine.



Great Performers.
Innovative Designs.

Don't take our word for it. This combination jetting and vacuum unit speaks for itself. Compare the powerful Aquatech Combination from the Hi-Vac® Corporation. You will discover Aquatech is the highest quality unit made. Simplest in design. Easiest to operate and maintain. And, is an engineered product that is custom-built – just for you.



Booth 4115

SINGLE ENGINE DESIGN

Dramatically decreases:

- Fuel and maintenance expense
- Sound levels
- Weight on chassis
- Initial purchase price

EXCELLENT FINISH

Body and all components are sand blasted resulting in a better looking, long-lasting finish.

High-quality 7-year guarantee on paint to match any color selection.

Driver has clear view of the road with boom and reel in rear.

Headlights are not obstructed with reel in rear.

NO FRONT REEL

Less wear on front end.

Eliminates premature wear of front tires, suspension, steering components and brakes.

Does not restrict air flow to engine.

Servicing engine is easier with reel in rear, allows quick and easy checks of engine fluid levels.

Allows for towing without reel removal.

POSITIVE DISPLACEMENT VACUUM PUMP

Belt drive is easily replaced and less expensive to repair than a hydraulic assembly.

Is more forgiving than a direct drive and hydrostatic drive.

TOP FRONT LOADING SYSTEM

Allows better separation of liquid so machine stays on-site longer.

Debris does not pile against rear door blocking the drain valve.

More even-load distribution increases stability on the road and eliminates rear door wear.

TRIPLEX RECIPROCATING WATER PUMP

Mounted chassis frame height.

Eliminating chance of damage when dumping debris.

360° WORKING RADIUS BOOM

Allows flexibility to place unit in safest working area.

Lift capacity of boom is 1000 lbs.

Boom hose has long radius with no sharp angled elbows to wear out.

Boom hose does not interfere with drivers sight eliminating a safety hazard.

Standard boom extension of 19' 6" lets you reach over obstacles in work area. (Additional lengths are available.)

Boom inlet is one piece hose, unlike units with tube-in-tube design that can jam or leak. Eliminates the expense of elbow replacement, due to wear.

REAR REEL ADVANTAGES

Places operator in safest and quietest location.

Operator works away from noisy engines, pumps & other moving parts.

800 ft. hose capacity is standard.

Rear mounting and high placement safeguards it from driving accidents.

Protects hose against road debris damage when driving.

Control panel at normal eye level.

Intake tubes are easy to dismount and mount.

RAISED CONSTRUCTION

Vital operational parts are mounted high eliminating risk of damage.

STEEL DEBRIS BODY

High-strength and corrosion-resistant.

WATER TANK IS GUARANTEED FOR LIFE

3/8" UV stabilized corrosion proof polyethylene.

Unlike metal tanks, they can be quickly repaired in the field.

Sediment can be emptied quickly by tipping and opening of valve.

no need for time-consuming manual cleaning.

EASY DEBRIS REMOVAL

Hydraulic, full-opening, rear door is standard.

Bottom discharge allows maximum off-loading of liquid without tipping.

Rear door locking mechanism is outside of tank instead of in sewage.



For a demonstration call: 740-374-2306. Toll Free USA: 800-752-2400. www.hi-vac.com



FRUITLAND VACUUM PUMPS. SIMPLY THE BEST

We are the #1 vacuum vane pump servicing the oil fields across North America.

The reason is simplicity.

**We don't need gimmicks or water cooling to serve the harshest of applications.
Simple uncomplicated design that works.**

Features:

- Every Pump "Factory Tested"
- Low Maintenance Cost
- Continuous Duty
- Air - Cooled
- No Washboard
- Vacuum to 28 hg.
- Pressure to 30 psi.
- ISO Certified
- 2 Year Factory Warranty
- Automated Lubrication System
- User friendly Maintenance Features
- Models for Tanks sizes from 1000 to 12000 Gallons
- Drive option include; Hydraulic, Direct, Belt, and Right - Angle
- Proven in all environments (sub-zero to 100 degrees plus)



Booth 8139

Markets:

- Industrial •
- Oilfield •
- Septic •
- Grease •
- Environmental •
- Wastewater •

**Used and Proven by
World's Top Liquid
Vacuum Service Companies.**

**Vacuum Pump Training
Courses available*

Fruitland Tool & Manufacturing

" Committed to Quality, Reliability, and Guaranteed Performance "

Contact us today: **1-800-663-9003**
Visit us @ www.fruitland-mfg.com For more info.

ALPHA Mobile Solutions



Manufactured by
Forest River



- Hot water heater
- A/C and heat strip
- 740 ga. waste tank
- 200 ga. fresh water tank

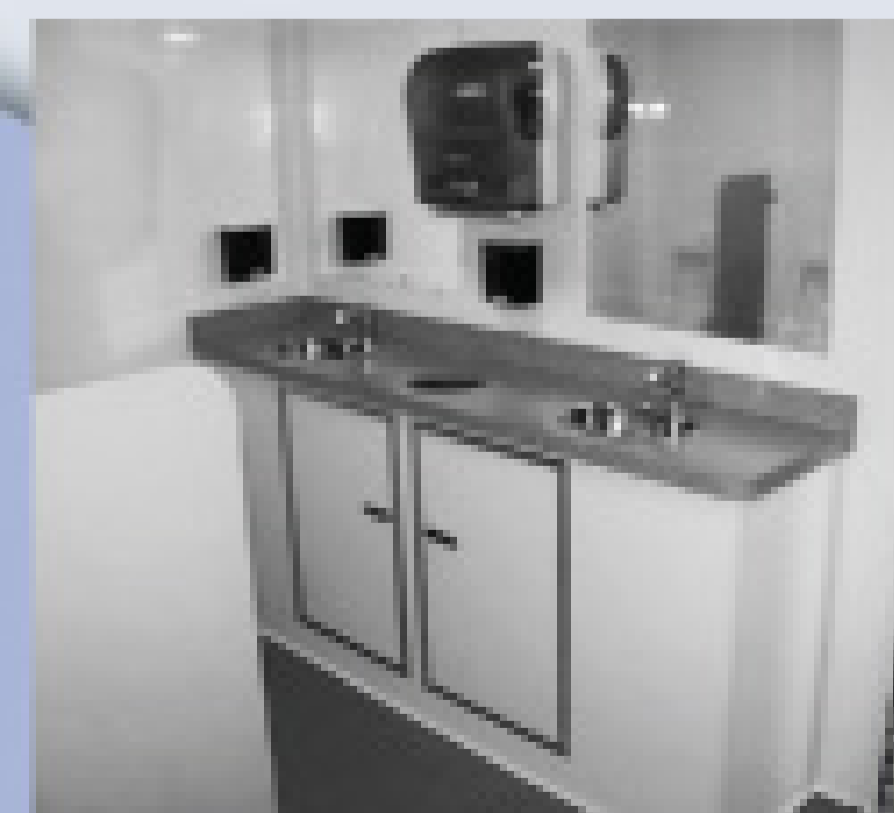

VISIT OUR BOOTH
11060, 11061, 11063
AT THE PUMPER SHOW
FOR FANTASTIC
DISCOUNTS

CALL FOR INFORMATION OR VISIT OUR WEBSITE

1-877-789-1213
www.alphamobilesolutions.com

RouteOptix Inc.

**Customer Service
Optimized Routing
Visual Dispatch
Asset Management
Disposal Tracking
Customer Billing**

Booth 3027

A Complete Software Solution

(866) 926-7849

www.routeoptix.com

info@routeoptix.com



2003 MACK CX
Custom Show Truck, 3600 gal US Tanks

SEE US AT THE LOUISVILLE SHOW



#5007, 5009, 6007



2003 MACK CX
4500 gal US Tanks, Custom Show Truck



2003 MACK CX
Red and White, 3600 gal US Tanks



2001 MACK CX
4500 gal US Tanks, In Production



2003 MACK CH 613
300K Original Miles, 4000 gal US Tanks, Double Frame



2000 INTERNATIONAL 4900
2200 gal US Tanks, Double Frame, MASPORT HLX75



2001 STERLING 9501
4000 gal US Tanks, Dump, C-12 410 HP, Ready To Work



2000 FREIGHTLINER
250K Original Miles, 3600 gal US Tanks, In Production



2001 STERLING
N14 CUMMINS, 4000 gal US Tanks, In Production

**Jetters,
Digital Level
Indicators &
Heated Valves,
No Problem**



1999 MACK CH612
2200 gal US Tanks



THANKS TO RESORT TRUCKING



THANKS AGAIN TO ROSE ENGINEERING

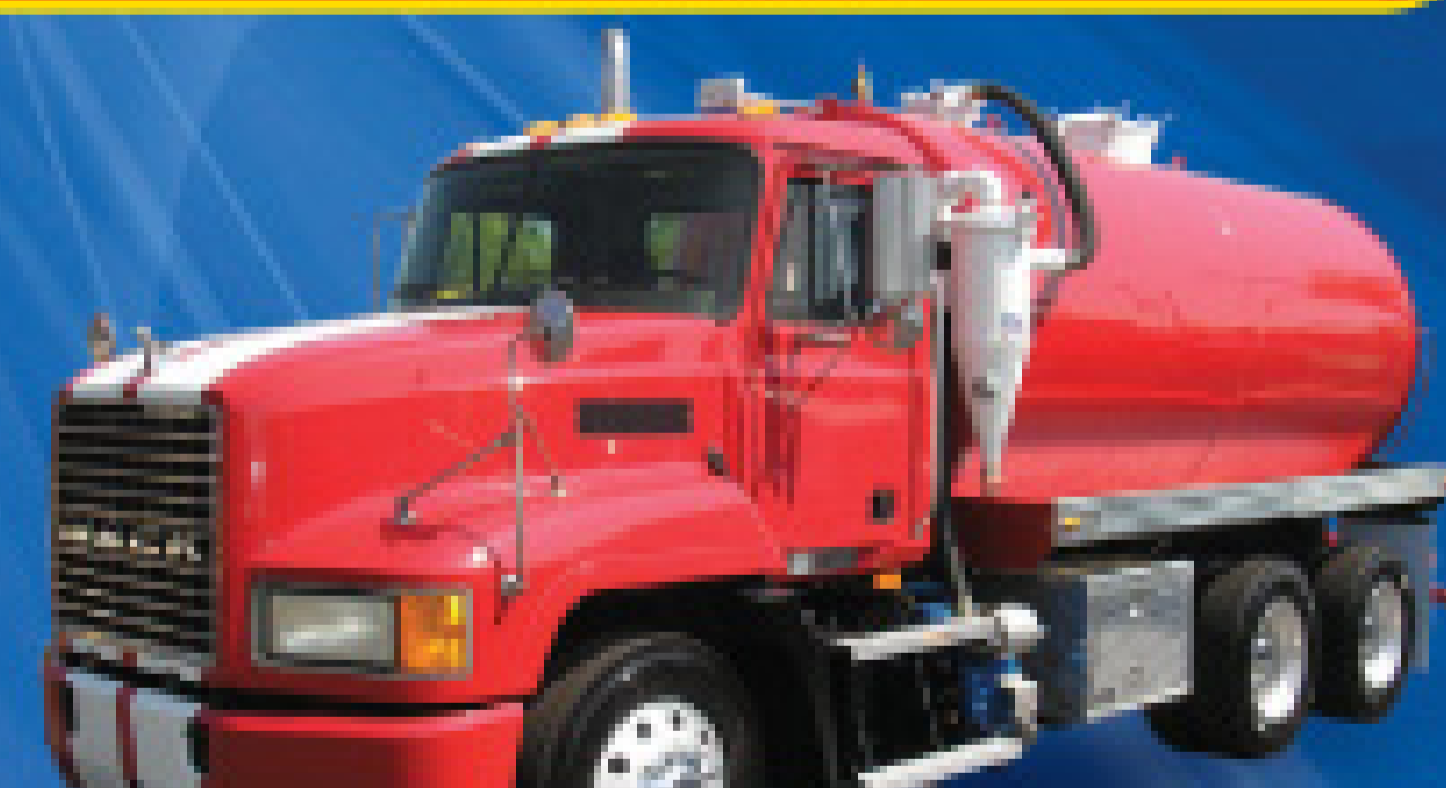

THANKS TO AMERICAN TRUCKING

Please Call
For More Info

ISRAEL VERA:
305-525-6406

Jurop or Masport water cooled pumps,
original pump brackets and accesso-
ries, double frame on all trucks 4000
gallons or larger is standard

OUR 28TH YEAR
NATIONAL TRUCK CENTER

9750 N.W. 27th Ave. | Miami, FL 33147

Phone: 305.691.8407 | Fax: 305.691.8416

www.nationaltruckcenter.com

★ **WE EXPORT OR DELIVER** ★

U.S.
Tanks
THE TOP DOG OF
VACUUM TANKS



Booth 6045

wallenstein portable sanitation

- > Quality construction
- > Rugged design
- > Wide fiber vanes
- > Easy internal access
- > Low noise level
- > Two year warranty

The most rugged, dependable, longest lasting vacuum pumps in the industry!



Model 302



Model 402

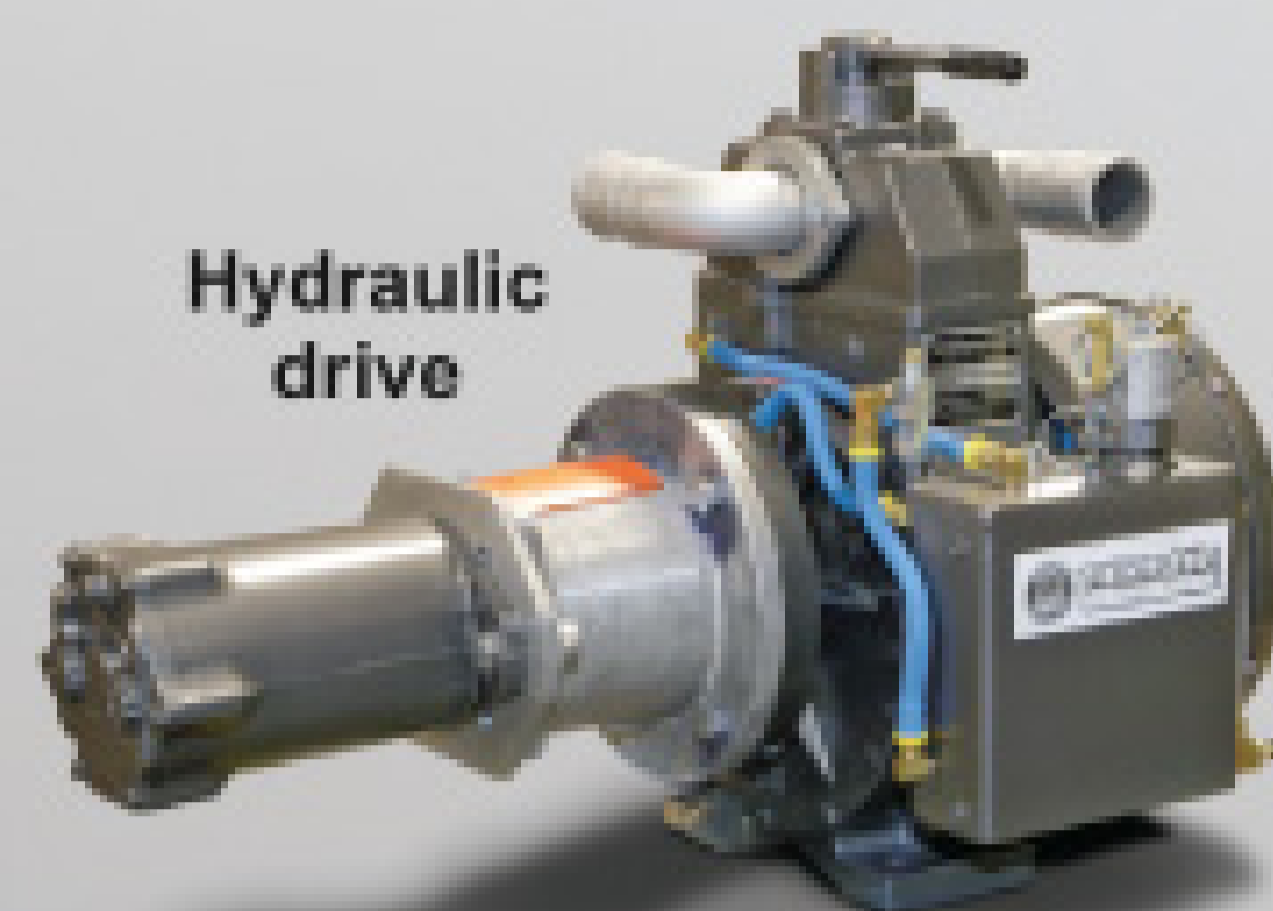

Hydraulic drive

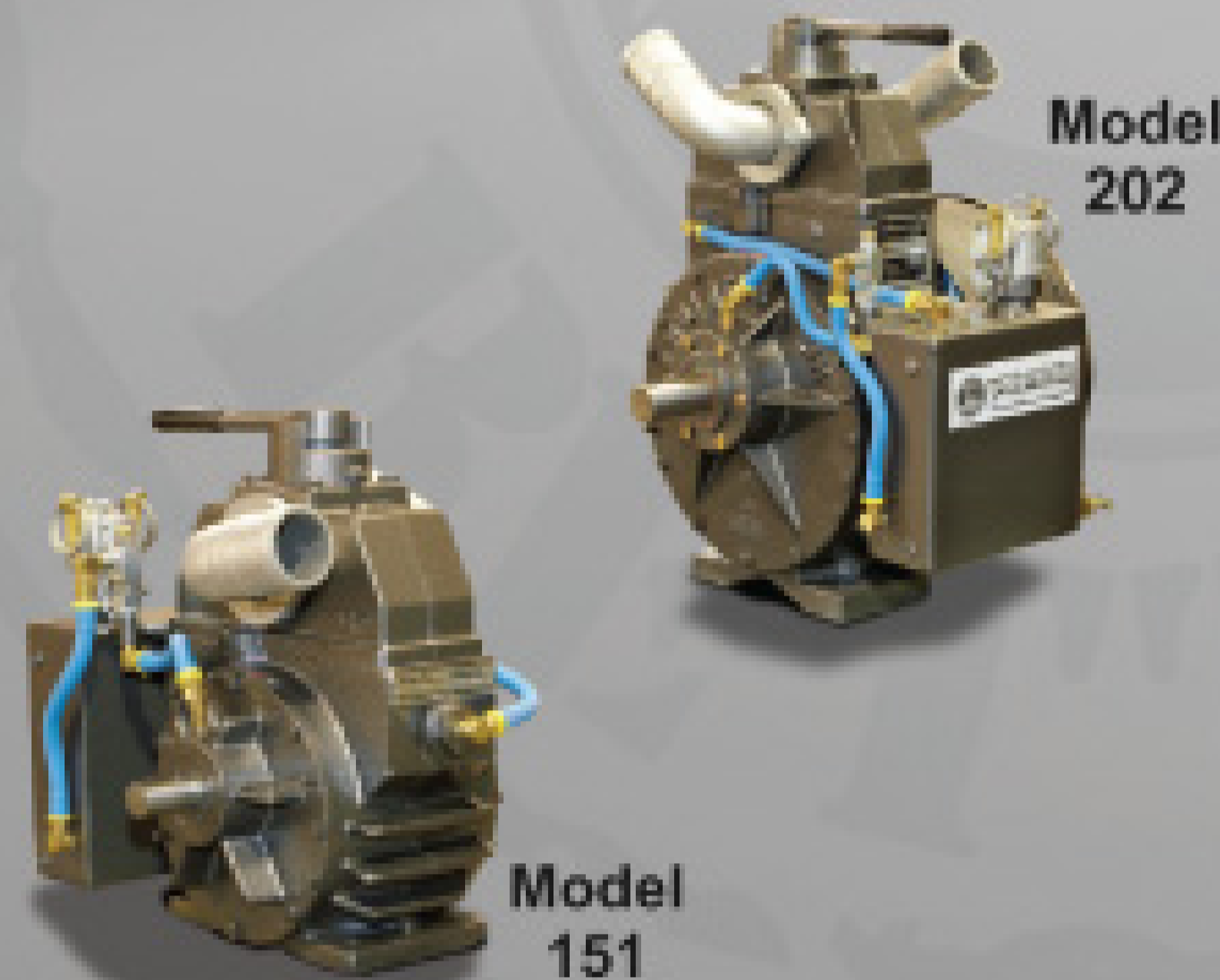

Model 151

Model 202

CALL FOR PRODUCT LITERATURE AND
YOUR NEAREST AUTHORIZED DISTRIBUTOR

Series	Rating CFM	Vacuum *HG	HP ^{gross} or ^{total} Engine	Tank Size US Gallon
151	80 @ 1750	27	5.5	500
202	115 @ 1150	27	11	750
302	165 @ 1150	27	13	1100
402	200 @ 1150	27	18	1500+

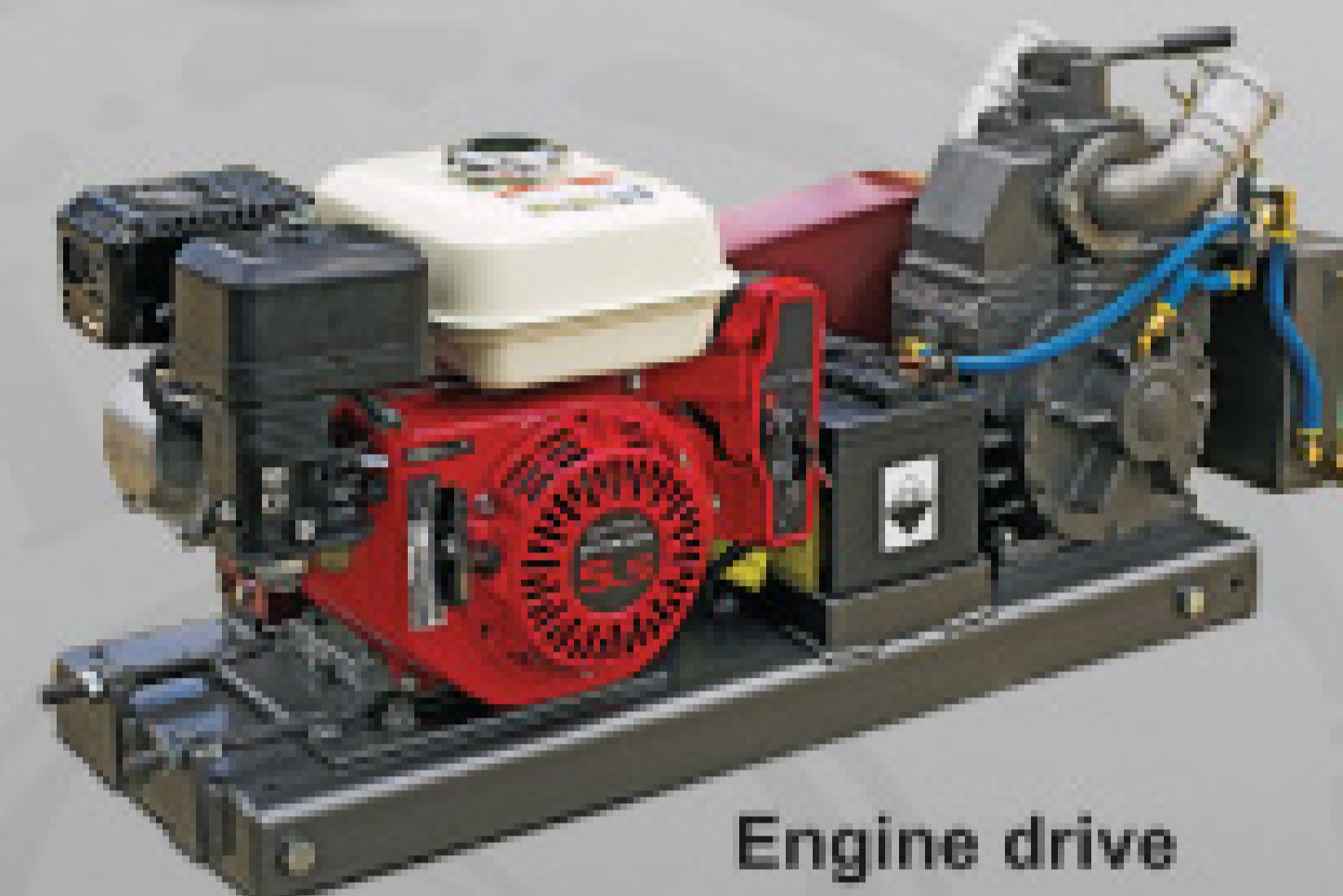

Engine drive

Toll Free 1-800-801-6663 fax 519-669-8331 email info@wallensteinpumps.com

PUT THE SQUEEZE ON WET WASTE ...
With Belt Filter Press Dewatering



Rentals

Skid Systems

Mobile Units



Made in the USA

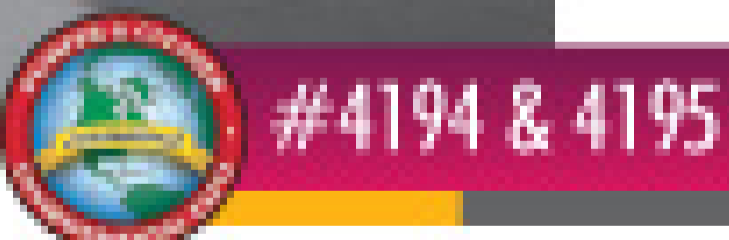

#4194 & 4195

Touch Screen Controls

Highest Dewatering Throughputs available

Stainless Steel Construction on Frame, Rollers and pans

Grease Trap Waste

Septage Waste

Industrial Waste

Toll Free: 800-253-0532

Phone: 269-793-7183 Fax: 269-793-8793

127 N. Water St., Hopkins, MI 49328

Contact: Julie VanderMoore at
julie@brightbeltpress.com
269-793-3423
www.brightbeltpress.com

WANT A TRUCK THAT REALLY SUCKS?



#7040 & 7041

Vacuum Trucks from Rocket Supply

The Amthor Matador Flat Vac

The Amthor Matador Flat Vac offers an exclusive improved tank design available in 5/16" aluminum, 1/4" steel and 1/4" stainless steel with capacities from 500 to 2000 gallons with full internal baffles. This unique body is used to service portable toilets and can carry 8 to 12 at one time, making it a very efficient vehicle. Features a rounded floor that allows for easy product drainage.

The Amthor Matador

The Amthor Matador offers an exclusive improved tank design available in 5/16" aluminum, 1/4" steel and 1/4" stainless steel with capacities from 500 to 7000 gallons. With full internal baffling and a heavier side shell than the competition, it allows for the absence of external rings, which provides a smoother looking tank when adding your brand or logo to it. Dumping options are also available.

For Excellent Price and Fast Delivery!

Rocket Supply

Since 1959

Contact Us for More Details



Roberts, Illinois • 800-252-6871 • www.rocketupply.com

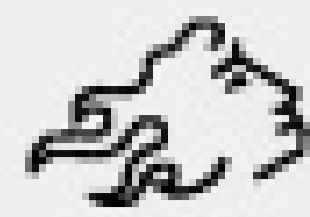

Placing a value on what you've built.

A knowledgeable buyer can make all the difference.

We own a portable restroom business in Southern California and are actively looking for potential acquisitions across the U.S. So if you have built a quality business in the portable sanitation industry, we would like to meet with you.

At Prometheus, we specialize in acquiring profitable, middle market companies in route businesses.



And we are especially focused on the portable sanitation industry. Here's why you should contact us:

CAPITAL

Whether you are looking to sell your business or are looking to grow, you need capital. We are a cash buyer and can complete a transaction quickly.



Also, our relationships within the financial community provide access to additional sources of capital necessary to grow

your business. If you are interested in selling a portion or all of your business or if you believe a committed equity partner can help you achieve the vision you have for your business, we would look forward to meeting with you.

Nicholas Peters
President and CEO

Chris Suh
Director

Chris Russell
Principal



PROMETHEUS

Agitation SAVES Aggravation!



VISIT US AT
BOOTH 64
AND ASK ABOUT
OUR EXPO SPECIALS

The Ultimate hand-held, powered agitator for septic tanks, grease traps and car wash pits

Saves Wear and tear on vacuum pump and equipment

Ergonomic shape and light weight helps to save your back

Extensions come in 2', 4' or 6' lengths

Mixes a 2000 gallon tank in less than 5 minutes

BE SURE TO
REQUEST A
FREE
INFORMATIONAL
DVD!

ASK ABOUT OUR "BUSTER BRACKETS" FOR TRUCK MOUNTING

"As the owners of 2 of your CrustBuster machines, we are happy to say they are the best investments we have made since we started our business. The days of back flushing, using a rake or a 2x4 for cleaning the tank are "Old School"."

— Don & Dawn Long, American Septic Service

CRUST BUSTERS

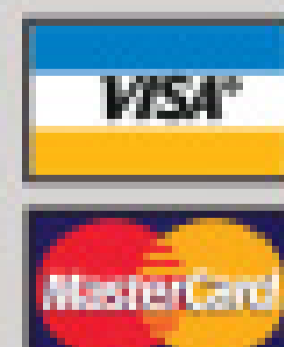

Schmitz Brothers L.L.C.
PHONE 763.878.2296
FAX 763.878.2299

E-MAIL pete@crustbusters.com
WEB SITE www.crustbusters.com

1.888.878.2296



Amthor Matador

We're proud to be an official distributor of



aluminum, steel and stainless steel vacuum tanks.



(888) 204-7872

www.stuarttank.com

Call TODAY for immediate delivery.

940 East Geneva Street PO Box 558
Elkhorn, WI 53121



#11044 & 11045



#7046 & 7047



toll free:
(866) 457-5425

EXPLORER

Toilet transporters

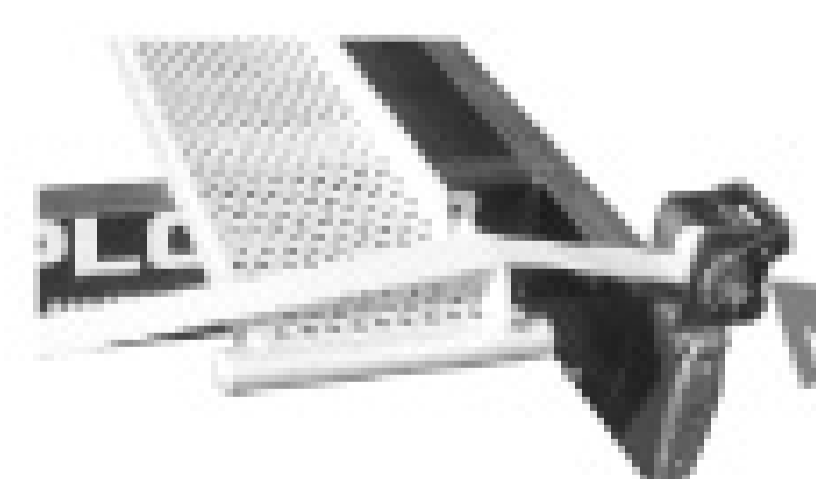

Secure Transportation for portable toilets with wooden or plastic skids!

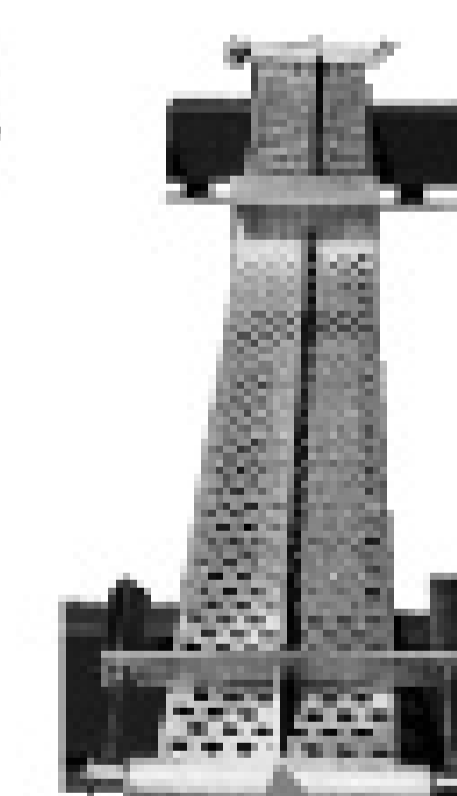

POSI-STRAP

POSI-CLAMP

Florida

STEVE BAE ENTERPRISES
Tel: (407) 709-8175
Fax: (407) 822-3998
Apopka FL

Texas

WOYT ENTERPRISES
Tel: (903) 586-6493
Fax: (903) 541-0874
Jacksonville TX

California

PLUMAS SANITATION
Tel: (530) 832-0370
Fax: (530) 832-0373
Portola CA

Colorado

Columbia Sanitary
Tel: (303) 526-5370
Fax: (303) 526-0686
Golden CO

Manufactured by:

McKEE TECHNOLOGIES INC.
ELMIRA, ONTARIO, CANADA N3B 2Z7

Already in the liquid waste business?

We have the perfect portable partner

The Red Box Plus Mini Series Container

- *Show Special* only \$1,700 per month
- Instant revenue stream
- Pull with your pickup
- No CDL required



Show Special of \$1,700 per month includes:

- Red Box Plus Trailhoist Trailer
- 15 Mini Series Containers
- 30 Portable Toilets

Ideal for:

- Small to Medium sized events
- Small Construction Projects
- Block Parties
- Graduation Parties
- Outdoor Wedding Receptions
- Golf Tournaments

Come see **RED BOX PLUS** at the Pumper & Cleaner Environmental Expo Feb. 27 – March 1

in the  **WASTEQUIP** Booth #4041

Check out our full product line at www.redboxplus.com

redbox+

818 West 3rd St. • Winona, MN 55987
(877) 611-8069

The Route to Profitability

Workload and efficiency with 'old-school' practices will dictate when you adopt automated scheduling

By Mary Shafer

Profitability in any business depends on keeping a handle on all your resources; knowing what needs to be done, how it'll happen, who's doing it, how they'll get there and when they'll be finished. When your business is pumping, that means maintaining a vibrant scheduling and routing protocol.

How pumpers handle scheduling and en route changes depends in large part on the size and structure of their businesses. The larger the company the more sophisticated the dispatching, while smaller firms tend to require less formal systems.

Not surprisingly, in an industry where business is fairly straightforward and transactions are still sealed with a handshake, many smaller operators show a reluctance to move to computerized scheduling and routing. The most common arguments against software are up-front costs, training time needed, and the fact that operators enjoy the flexibility of being able to make changes on the fly.

Others admit to having at least considered automating processes, if not for their own convenience in recordkeeping, then to accommodate official reporting requirements or to maintain a higher level of customer service. The most frequent advantages cited for dispatching software seem to be time savings in scheduling changes, the ability to use the reporting function to gain a better understanding of the overall service picture, and the ability to program automatic service reminders for customers.

These contractors share what works for them, and why.

Shawn York is still fairly new at running Mid-Mo Earth Works, a septic installation, pumping and maintenance firm in central Missouri. With 11 employees supporting a single pumping route, his dispatching needs are fairly simple.



Name: Shawn York, owner
Company: Mid-Mo Earth Works
Location: Jefferson City, Mo.
Employees: 11
Years in Business: 3

When a call comes in, York's secretary calls him over his cell phone in his truck. He checks his schedule on a PDA and lets her know when another call will fit in, then updates it on the spot.

"We've run into a few times where customers have asked about us getting an automated system. Our county is considering mandated pumping for environmental reasons. If that happens, I'll definitely have to go to something automated so I can issue reports."

Bobby Hargrove

Comments may be directed to Mary Shafer in care of Pumper. You may also e-mail pipelines@pumper.com.

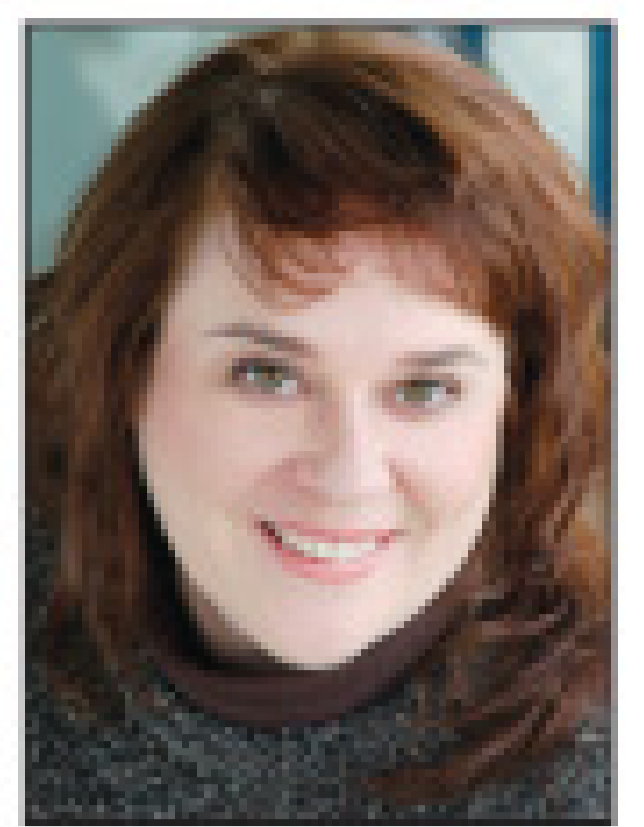

Mid-Mo services several regular maintenance contracts for grease traps. The specified 3- to 16-week intervals make scheduling easy. As long as service remains inside those parameters, actual service times are flexible.

"I'd move to software if we grew to take on a second route, because then I think we'd need it. I've actually thought about developing our own program, and I may yet do that," he says.



Name: Al Smith, owner
Company: Smith's Pumping
Location: Kingston, Ontario
Employees: 8
Years in Business: 25

Al Smith's family company, Smith's Pumping, has been going for 40 years, but he's been pumping septic and holding tanks for the last 25. Even with such lengthy history, Smith's still operates a fairly simple and straightforward dispatching system without the use of computers.

"All our scheduling is managed from the truck," Smith explains. "Service calls come in to a 24-hour answering service, and the call is paged to the senior driver's truck via text message over a cell phone. A hard copy record of the request is also sent to the office.

"We do a lot of same-day calls, so a lot of our business is unscheduled. The senior driver takes those calls and schedules himself and the junior drivers in a second truck. I only get involved if there's a serious conflict in prioritizing jobs or arranging logistics." This might include procuring special equipment to accommodate extensive hose lengths, special fittings or other unusual needs.

Because the company has a long-term contract with Canadian Northern Railway, that customer's jobs take precedence over others. Smith also occasionally pumps holding tanks from boats in port on Lake Ontario. Because both of these jobs may require extensive travel times, the pumper occasionally runs into scheduling conflicts. At those times, Smith will subcontract the work to another pumper.

"Our customers are very understanding, and they appreciate that we're willing to go out of our way to make sure their service gets done, even if we're not the ones doing it," he says.

Bobby Hargrove also makes maintenance contracts the cornerstone of his company's work schedule. The contract, drawn up by a lawyer, is a general service outline, rating services recommended per 1,000 gallons pumped. "We probably need to update it," he admits.

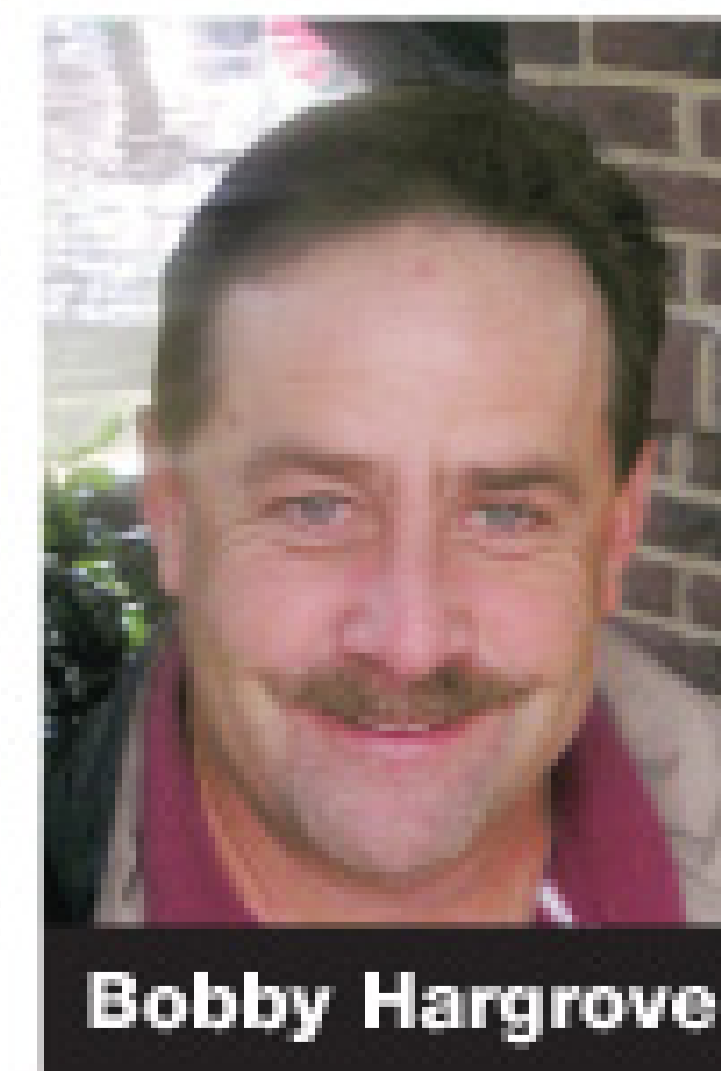

Name: Bobby Hargrove, owner
Company: AAA Septic Service
Location: Chattanooga, Tenn.
Employees: 6
Years in Business: 50

"But we like the contract work. We can know two weeks out what our workload will be, so it makes it easy to spread the other work around scheduled maintenance. But I still like the handshake approach for other work. We're old school," he says. When a service call comes in, Hargrove's secretary schedules it in a manual system. Any changes to a driver's schedule while on the road are relayed via cell phone from the office.

"We've run into a few times where customers have asked about us getting an automated system," Hargrove says. "Our county is considering mandated pumping for environmental reasons. If that happens, I'll definitely have to go to something automated so I can issue reports." ■

Bonus

PIPELINES PLUS: To upgrade dispatching or not?

Deciding if and when to switch to an automated dispatching system is important to growing businesses that want to stay on top of cost efficiency. It's a business move, so make the decision based on reality, not emotion.

If you begin to notice a drop in productivity, take a good look at all your business processes. If you determine that scheduling and routing is the bottleneck, but have reservations about investing in software, examine your options to make your current system more efficient.

Ask your staff to keep careful records of problems encountered in their dispatch efforts. When you reach the point where the elimination of consistent scheduling conflicts, missed calls, incomplete records and customer complaints outweigh the time and expense needed to implement and train your staff on an automated system, it's probably time to switch.

TrakMats®

Ground Cover Mats For The Professional

- * UV protected
- * Tough, Lightweight
- * Power Cylinder Cleats
- * Hand cutouts for lifting
- * 100% Recycled Material
- * Unaffected by heat & cold
- * Light color prevent burnt grass



Booth 3031

No more Ruts,
Damaged Lawns or Weather
Delays.

No more Heavy, Wet, Rotten,
Broken, Slippery Plywood

www.trakmats.com
sales@trakmats.com

Charlotte, NC 28216
Fax: 704.398.0540

800.762.8267

SVE Sales, Inc.

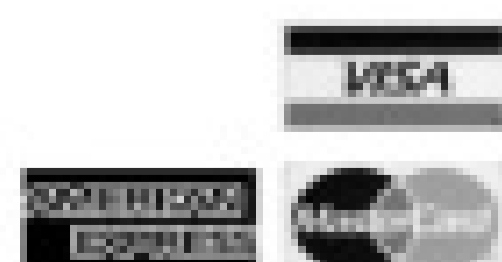

Quality People Doing Quality Work

Industrial Vacuum Units

DOT Code & Non Code Vacuum Trailers



Vacuum Septic Units

Aluminum or Steel Tanks in a Variety of Capacities



Portable Restroom Service Units

IN STOCK - 650/300 gal.
Call for Details
Ready for Immediate
Delivery -
Priced at
\$54,900



Mini Vac Trailers

DOT
Code
& Non
Code



Slide-In Units



IN STOCK - Slide-In Portable
Restroom Units - Call for Details
Industrial Skid-Mounted Units
Also Available

Marsh

INDUSTRIAL

P.O. Box 1107 - 135 E Mile Road - Kalkaska, MI 49646
p: 231.258.4870 - f: 231.258.2019 - sales@marshind.com

800.952.1537 - WWW.MARSHIND.COM



CLEAR COMPUTING *with* INSIGHT

Total Activity Control

Street Eagle GPS Tracking

TACTrackerPRO



- Vehicle Tracking
- Service Verification
- Production Reporting

See Us at
Booth 3173

FREE Credit Card Integration with NXGEN!

Clear Computing
(888) 332-5327

www.clearcomputing.com



Insight USA

(301) 866-1990 x201

www.mds-inc.com

FACTORY AUTHORIZED SERVICE

for: *ROOTS-DRESSER, ROBUSCHI, HIBON, H&H, HOLMES and KAISER Blowers*

**Fast Delivery - Large Selection - Best Price - Great Service
New - Rebuilt - Core Exchange**

**Exchange Units - Most Models
of Roots, Robuschi, Hibon,
Holmes, H&H and Kaiser**

- ◆ Roots 1125 Trinidad
- ◆ Roots 1021 DVJ
- ◆ Roots 1024 RAS
- ◆ Roots 1021 RAS
- ◆ Roots 824 RCS
- ◆ Hibon SIAV 840
- ◆ Hibon SIAV 8702
- ◆ Hick Hargreaves 4084



**New Blowers & Pumps
Available From POWER VAC**

- ◆ Roots
- ◆ Robuschi
- ◆ Hibon
- ◆ Hick
- ◆ Masport
- ◆ Moro
- ◆ Aerzen



hibon KAISER

ROBUSCHI

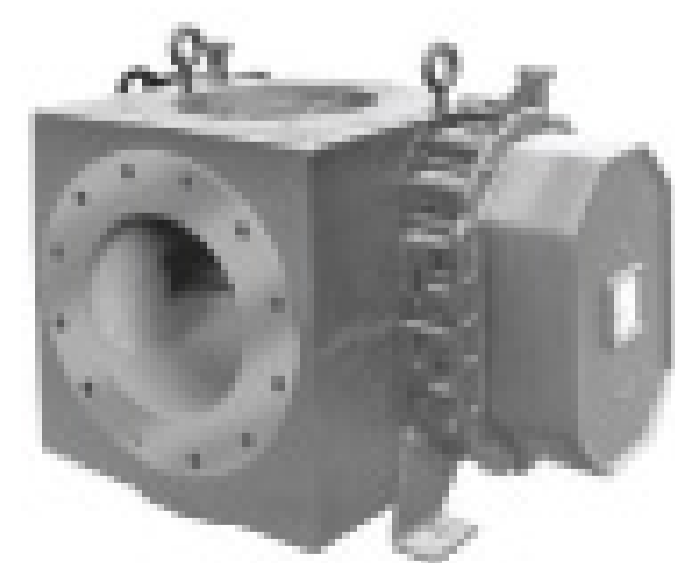

1-800-822-4887

W228 N2792 Duplainville Rd. • Unit G. • Waukesha, WI 53186
(262) 542-8989 • Fax: (262) 542-6262 • www.powervacinc.com

When Service Life is Important,
Get the 25-Year NO Rust Guarantee



- Dewatering Systems
- Composting Systems (ECS)
- BOD COD Reduction Systems
- Polymer Systems
- Financing Available



**It's Smart to Protect Your Investment,
Get the SMART 25-Year Guarantee!**



Multiple Purchase Options Available with Financing

If you want experience, give John a call.

1-800-899-1802

P.O. Box 782265 • San Antonio, TX 78278

210-269-3910

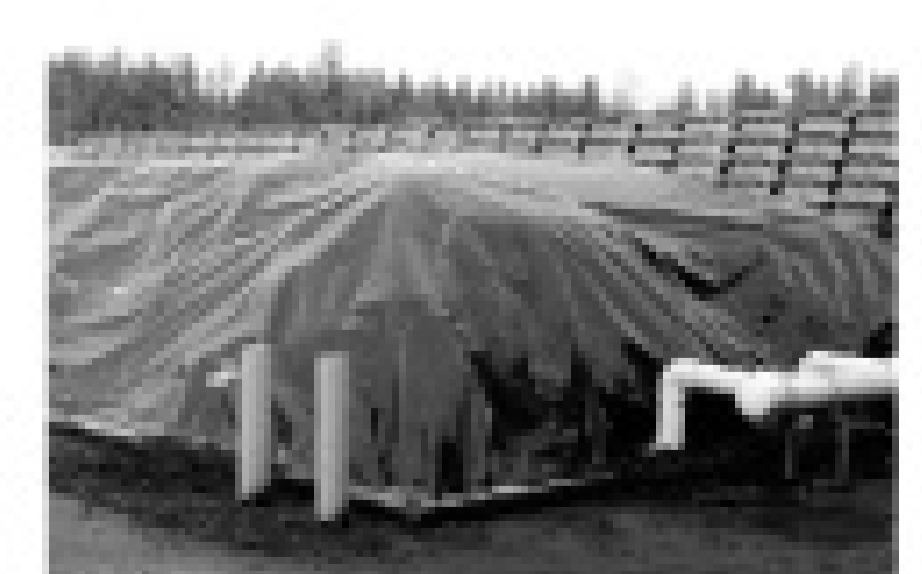

www.smartdewatering.com

And They're Off!!!



Show Special Pricing on ALUMINUM Vac Trucks!

See you in Louisville! February 28 -> March 1st

PRsT - 1500 Gallon w/Carrier
Dual compartment (1100w/400f)
Call now for 2007 prices!

PRsT Restroom Trucks



& PRsT Combos

Unheard of Discounts + TOP QUALITY!

2800 Gallon VTa's
Single Compartment pumper tanks,
Visit online or call for pricing!

Get Ready for LOWER Monthly Payments!
Ask about finance options.

3600 Gallon VTa's
Single compartment fully equipped
You want it? You got it!

Dealer Discounts Aimed to Please!

4200 - 5500 Gallon VTa's
Single compartment fully equipped
EXTREME Values on 07's

VTa Pumper Trucks



Ready to ROLL!

Get The Vehicle Your Business NEEDS!

7000 Gallon Aluminum
Pumper Trailers.
Hard to find, but we got 'em!

Vacuum Trailers



Haul More...

Check out our inventory online
visit: www.AlliedTank.com

1000 to 6000 gallons | Plain Jane or Tricked Out custom!

Call Allied Tank - Today
1-800-355-1300

Are you ready for the BEST trucks?
We hear it over and over how "Allied Tank Trucks are simply built better than the others". If you're looking for a truck that's built right, you're looking for an Allied Tank VTa Pumper or PRsT Restroom truck!

IMPORTANT! - DON'T MISS!

Pre-2007 Mandate¹ Chassis in stock!

Supply is limited, don't wait and miss out - call now!



FREIGHTLINER



Peterbilt

Pick your chassis...

GMC

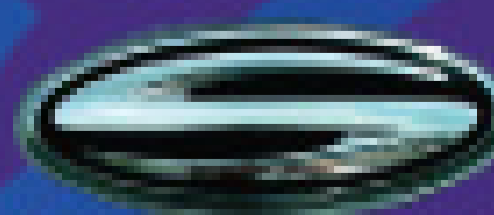
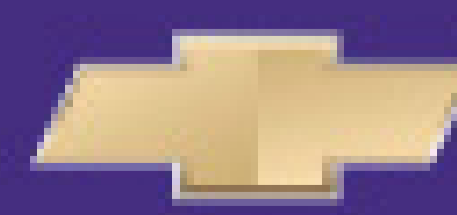

ALLIED TANK TANK

1. 2007 Mandates require engine specific mandatory updates, call for info.
© 2007, Allied Tank/Autotank Co. Inc. All rights reserved.

Great Trucks, Less Bucks!

Introducing
**SPG
TANKS** INC.

North Carolina's NEW Full Service
Vacuum Tank Truck Dealer

Portable Restroom Units



Flat Vac Units for Portable Restrooms



Septic Units

- Aluminum, steel and stainless steel tanks
- Numerous bare tanks and chassis in stock.
- A full line of portable restroom, single-axle and tandem units, completely assembled in stock ready for immediate delivery.
- Full financing and leasing packages available.
- No external rings and 5/16" sideshell on aluminum tanks with full head baffles. The thickest aluminum tanks in the vacuum industry.

Call for
info/prices/details

OFFICIAL DISTRIBUTOR
AMTHOR
International



16022, 16026, 17025



**SPG
TANKS** INC.

1804 Flint Hill Drive
Hickory, NC 28602

ROY COFFEY
President

(828) 312-9545
rcoffey2256@conninc.com

MyTana

Check out our **NEW**
website www.mytana.com



**Come see us in Louisville, KY
Booth # 8089**

The Septic Saver

- Great for 3" - 4" lines

- Belt driven

- 1/3 HP motor



M755

For a FREE Catalog... Call Toll Free: 800-328-8170 Fax: 651-222-1739 Request: www.mytana.com

Advance

PUMP & EQUIPMENT INC



Buy Now & Get
FREE
Pumping Hose!

3600 Gallon Alum Vacuum Tank

- 2007 Pre-Emission 7500 Series IH
- 506 Challenger pumping system



Booth 5199, 5201, 6199

6000 Gallon Short Tanker Trailer

- Excellent for Septic & Grease Trap Service.
- Call for more Information

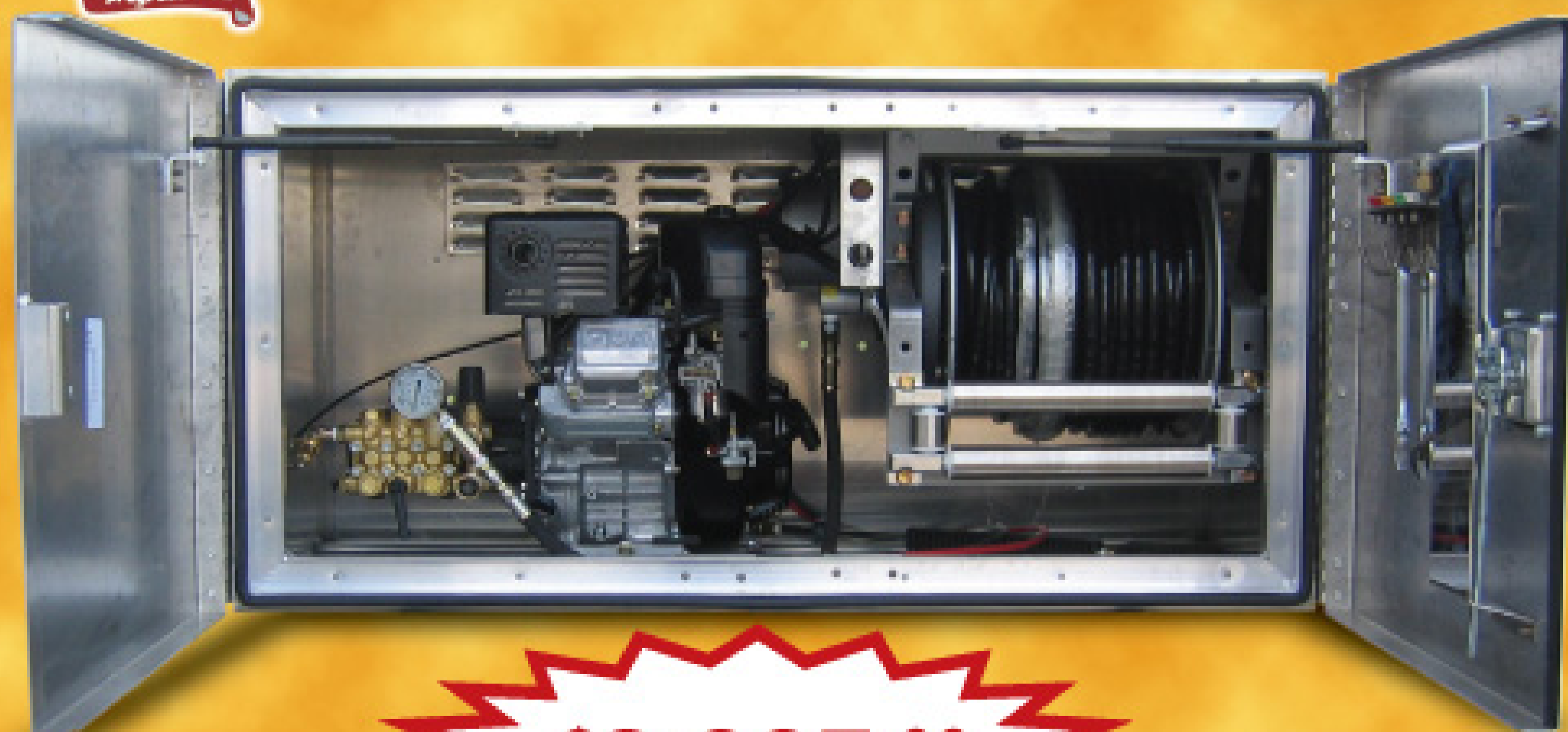

\$3,995.00

Toolbox Jetter

- Polished Aluminum Toolbox
- 5 GPM @ 3000 PSI Water Pump With Pulsator
- Electric Start Engine
- Remote Fuel Tank
- Electric Rewind Reel With 200' of 3/8" Hose
- Chrome Guide Rollers On Reel
- Washdown Gun With Quick Connect Tips
- (1) Jet Nozzle
- Stainless Tool Rack

Add Jetting To Your Pump Truck

NVE
DISTRIBUTOR

Toll-Free 1.877.557.PUMP (7867)
"Partners in Performance"

Call For A Quote Today!

www.AdvancePump.com

15418 Old Highway Road • Peosta, Iowa 52068
877.557.PUMP (7867) • Fax: 563.557.0961

No COMPROMISE



Don't accept a substitute for quality. The Burks DC-10 is still the most popular, high volume washdown pump available.

With flow rates to 20 gpm and pressure to 40 psig, the Burks DC-10 is the pump of choice for filling and washing your portables.

Contact your local tank manufacturer for more info, or call us toll-free at:

800-699-7557

**ARMSTRONG
EQUIPMENT
INC.**

11200 Greenstone Ave. • Santa Fe Springs, CA 90670
562-944-0404 • Fax: 562-944-3636

www.vacpump.com



Comfort Elite Mobile Restroom Trailers

**Booth
4212**



Come see what over 50 years of trailer manufacturing experience can do for a restroom. Come see what the other guys will be trying to keep up with next.

Ask Us About Our NEW:

- ◆ GPS Monitoring System
- ◆ Negative Ion Air Purifiers
- ◆ Lead Referral Program
- ◆ Corian Countertops
- ◆ New Platinum Edition
- ◆ ADA Units
- ◆ Arctic/Winter Packages

Effective **Solutions.** Uncompromising **Quality.** www.wellscargo.com **888.574.4222**

FREE DELIVERY!



Booth 9003

On **ANY NEW** Vacuum Service Tank Truck*
To the Pumper Show, Louisville, KY

February 28 - March 1

Time is running out ...ORDER TODAY!



*On **ANY AVAILABLE** New Chassis & New **progress tank**

Taking AIM at Ford 550 and the Chevrolet 5500

NEW! 2008 Sterling Bullet

Cummins 6.7 Liter Turbo Diesel 305 HP / Automatic transmission
7,000 lb. Front Axle 13,500 lb. Rear Axle
Exhaust Brake, AC, AM/FM-CD, Cruise,



1500 Gallon **PORTA VAC**

1100 Waste / 400 Fresh / Masport HXL4
Burks washdown / Hot Shift P.T.O.

\$66,400

Lease from **\$1328.** mo
4 Wheel Drive ... \$71,495

200 Services
FREE DEODORANT
With Purchase Of Your
Toilet Truck or Slide -In



435 Gallon 300 Waste / 135 Fresh
Other styles and sizes available
Call for pricing and availability

2008 Ford F750 25,999 GVW

Diesel, auto. transmission, air brakes.
2200 Gallon ALUMATANK
360 CFM pump, Hot Shift P.T.O.,
60" Tool Box

\$80,700

 As Low As \$1,614 mo.

800 Gallon Combo Unit

10' Bed with Liftgate
2007 Ford 550 XLT
Upgraded interior.

\$72,230

Monthly lease from \$1,446



Flexible Financing Options To Fit Your Needs.

Call **TRANS LEASE, INC.**

Randy Satrom or Cassie Bergo

877-600-6423

Get Pre-Approved or Approved At The Show



Distributor of: **Masport**

KeeVac

Industries Inc.

Call Kevin. Call Matt. ...**Just Call KeeVac**

866-789-9440

www.keevac.com



Kevin Keegan
31 Years Experience

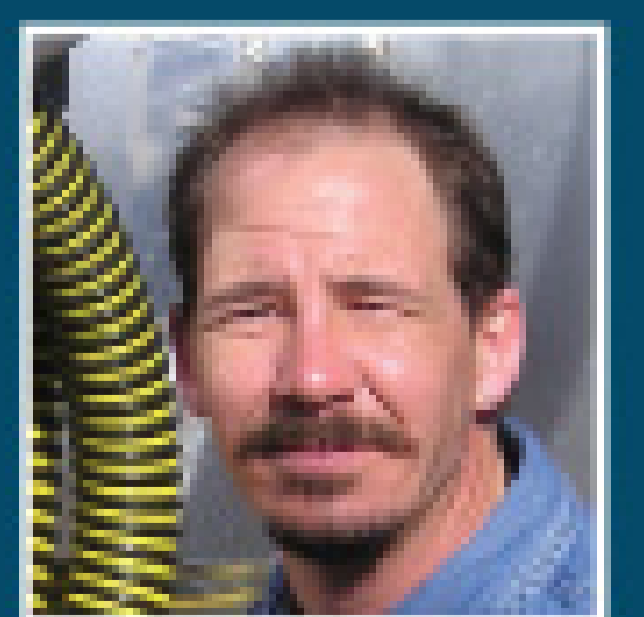
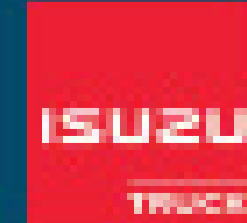
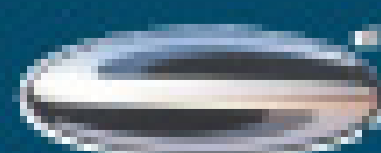

Matt Crowell
17 Years Experience

Experience Matters.

Custom vacuum tanks built to your specifications.

For nearly 50 years, our tank builders have been setting the industry standard for innovation and value. Everything we build is customized to your exact specifications. Start with a bare tank and add only the options that are suitable for your application. What about service? Our technicians can rebuild pumps or furnish parts such as vanes, seal kits, housings, and rotors for most pumps. Whatever you need, let us put our experience to work for you.



Bare tank w/no attachments

Bare Tank:

Prices are for the tank only with no openings, hatches, rails or other attachments. LMT can furnish items for you to attach to your tank at additional cost. Please call for more information and pricing.



Basic tank w/optional manway and hose trays

Basic Tank:

Prices include primary shutoff, full length rails (straight or tapered), 4" discharge nipple, and 3" intake nipple.

Check out some of the options:

- ✓ Manways (20", 25", 36")
 - ✓ Full open door (2 types)
 - ✓ Primary & secondary shutoffs
 - ✓ Valves for loading & unloading
 - ✓ Oil catch mufflers
 - ✓ Suction hose & couplings
 - ✓ Mounting rails & kits
 - ✓ Vacuum pumps (Jurop, Masport, Moro, Fruitland, and others)
 - ✓ Hose trays and hangers
- And more...

LMT Basic & Bare Tank Prices:

(subject to change without notice)	Basic Tank	Bare Tank
1500 gallon: 54" dia. x 12' long w/1 baffle.....	\$ 4,345.....	\$ 2,958
2000 gallon: 60" dia. x 14' long w/2 baffles.....	5,406.....	4,037
2500 gallon: 66" dia. x 14' long w/2 baffles.....	6,145.....	4,753
3000 gallon: 68" dia. x 14' long w/2 baffles.....	7,162.....	5,728
3500 gallon: 72" dia. x 17' long w/2 baffles.....	8,660.....	7,138
4000 gallon: 78" dia. x 16' long w/2 baffles.....	9,784.....	8,226
4200 gallon: 78" dia. x 17' long w/2 baffles.....	10,272.....	8,689

Custom sizes up to 6000 gallon are available.

All lengths are in length excluding flanged and dished ends. All tanks over 70" dia. have 2 braces of 2" x 3" solid steel to prevent collapse of tank. All tanks are cleaned with an acid solution and prime painted. We can also customize the paint color for an extra fee. Tanks are manufactured with mild steel and are welded with submerged arc process for the best strength and appearance. Stainless steel is available at extra cost.



Call us at 800-545-0174 before you buy!

LMT Inc. - Custom Vacuum Tanks

Tel: 309.932.3311 • Fax: 309.932.3155 • info@tanksandpumps.com

www.tanksandpumps.com

ELITE-DUO

DVD AND VHS RECORDER

PLUMBER'S MATE

Affordable Mainline System

MINI MAINLINE

Self Leveling Camera

See Further. See Clearer. See Everything.

3/4" BW Camera

512HZ LOCATORS

ROLLER SKIDS

Booth 144

Ratech

See Everything.

800.461.9200 905.660.7072 www.ratech-electronics.com sales@ratech-electronics.com

DEWATERING MADE SIMPLE.



Sludge Mate & Poly-Mate

The Flo Trend® Sludge Mate® and Poly-Mate® form an economical and simple to use sludge dewatering system. The Poly-Mate® conditions sludge through the addition of polymer prior to the dewatering process which occurs in the Sludge Mate®. These units are designed to dewater sludge from a multitude of waste stream sources including: water and wastewater treatment plants, septic tanks, car washes, industrial sumps and lagoons, grease traps, rendering plants, and food processing plants. The Sludge Mate® and Poly-Mate® are available in a variety of sizes and configurations, and are built to custom specifications.



#5187 & 6187

Flo Trend Systems
707 Lehman St.
Houston, TX 77018

Tel - 713-699-0152
800-762-9893
Fax - 713-699-8054
sales@flotrend.com

Patented Technology for Pumping

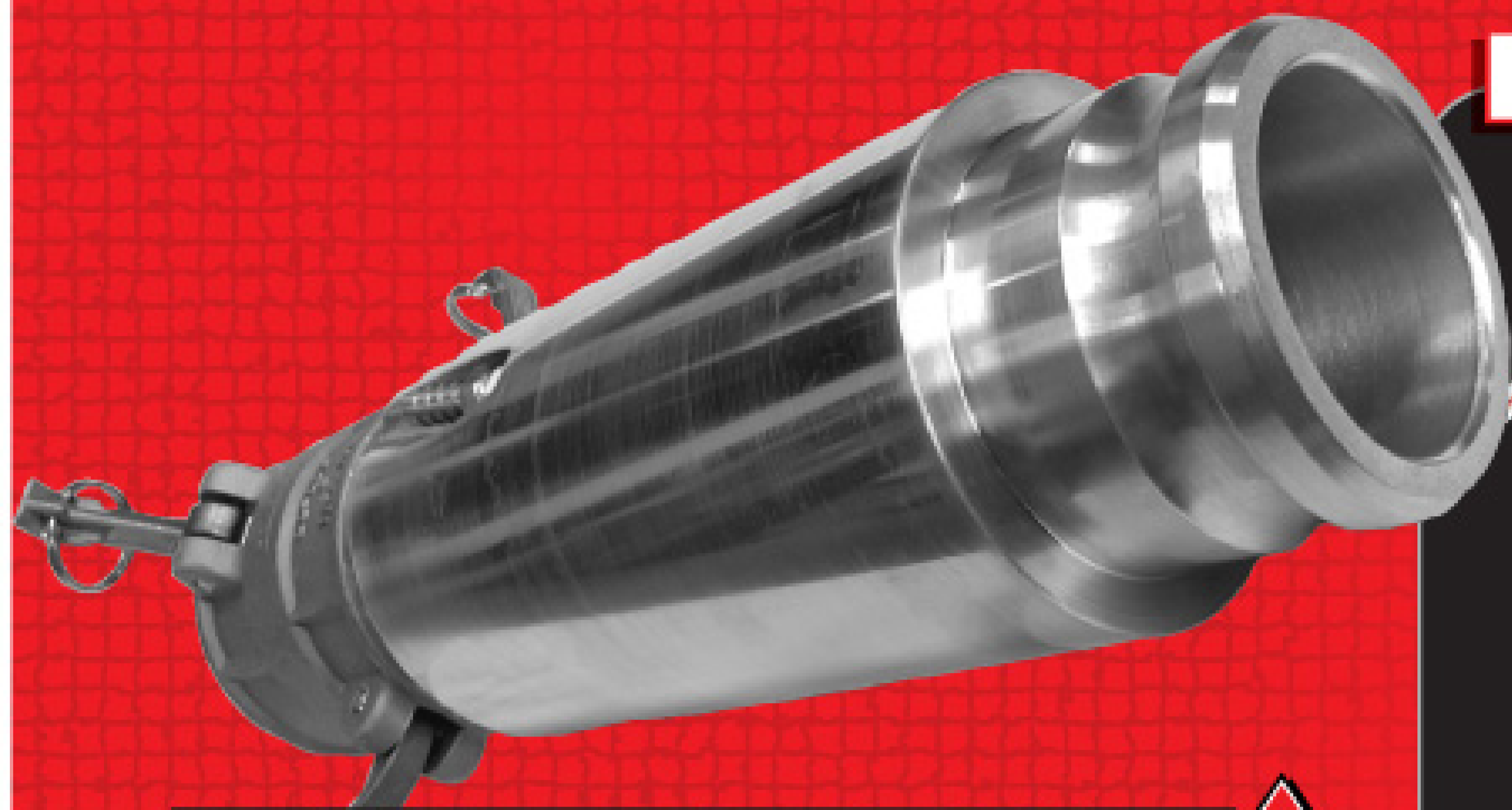

PL Pressure Lift Corp

- REDUCE PUMPING TIME
- INCREASE VERTICAL LIFT CAPABILITY
- INCREASE VACUUM PUMP PERFORMANCE
- DECREASE WEAR ON PUMP & EQUIPMENT

POWER BOOSTER

The Exclusive Show Source
CAPITAL RUBBER CORP



Booth 3093

**CALL TODAY FOR A
FREE DEMO DVD**

Pump Deeper – Pump Quicker

972.355.0550

www.pressurelift.com

Portable Sanitation & Septic Pumper Supply



Restroom Deodorizers



Whale Foot Pumps



Soap Dispensers



SHURflo Pumps



Hand Sanitizers



Cam & Groove Fittings

Burks Pumps



Replacement Flooring

Banjo Valves

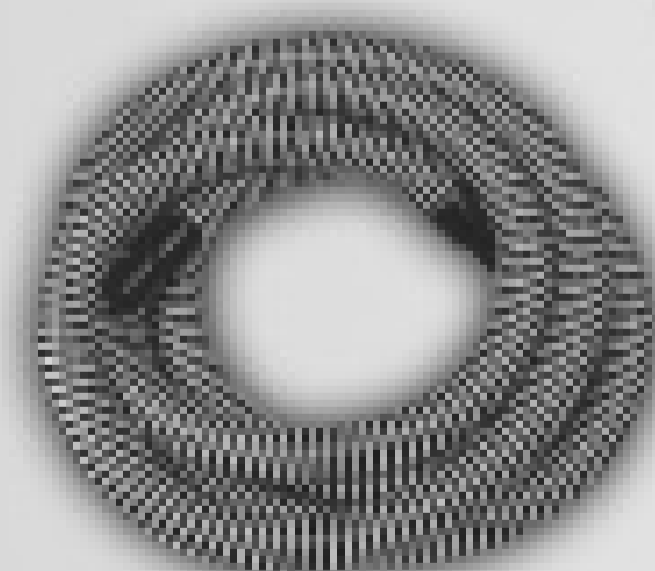

Wand Assemblies

Wind Cables



Pressure Gauges

Hi-Vac Hose

Gloves

Rivets

Locks

Liquid Waste Industries, Inc.

3380 Town Point Drive, Suite 350
Kennesaw, GA 30144

Phone: 877-445-5511 or 770-424-5575

Fax: 770-424-5536



Toilet Seats

Valves

Tissue

and More!



Same Day Shipping on Orders Received Before 3:00 pm EST.



Call Toll Free 877-445-5511 • Or Visit www.lwiinc.com



#7013-8011



BIO-SYSTEMS Int'l is an ISO9001:2000 certified manufacturer in business since 1986.



Combined forces to better service your needs.

Septic Tank Additives



"SK3" is a powdered septic tank additive that will boost biological activity and promote sludge settling. 20 x 1 year supply per case. Private label is available.

Pumper Expo Special!



CHECK OUT THIS EXCITING NEW PACKAGING OPTION!

only **\$6.00** per individual pkg.

Pumper Expo Special!

Long Lasting Pink Cube

\$160

per 4 x 5lbs.

"Pink Cube" is a commercial grade solid degreaser designed to last in hard to service liftstations & grease traps.



Sewer Foam

\$59.75

per pail

Reduce solids and hydrogen sulfide odors. An effective and economical approach to sewer maintenance.

Complete Product Line

Septic Tanks

Lift Stations

Drainfields

Garbage Disposals

Odor Control

Portable Toilets

Cleaners

Urinals

BIG SHOT Toilet Treatments, Packets & Tablets

Super Strength Concentrates—choose non-formaldehyde and formaldehyde blends in a wide array of fragrances—liquid, dissolvable tablets and packets.

NEW fragrances - Clean Cotton and Wildflower!

NEW IMPROVED FORMULA!



Increased fragrance, dye & now with effervescence

BUY DIRECT AND SAVE!

CALL NOW!

1-800-423-5350

or visit us online at www.chempace.com

See us at Pumper Expo booth #6075.

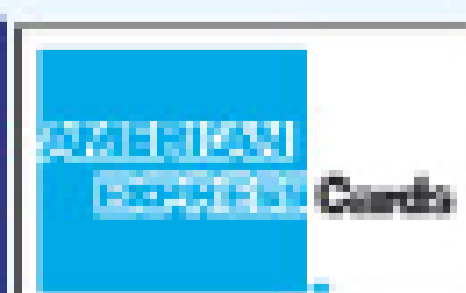

Private label is available for most products. Request brochures at time of order. For more information and products visit www.chempace.com. Not combinable with other offers. No quantity limits. Call for details.

Basic Training II: Mound Systems & Beyond

A newly minted onsite system inspector gets more advice on how to work effectively with installers

By Roger E. Machmeier, Ph.D.

This is a continuation from last month's question from a new inspector getting started on the job.

Previously I wrote about getting to know your installers and how to check on a basic onsite trench system. This month I will elaborate on mound systems and some other features of an onsite sewage treatment system.

Sewage treatment mounds have become popular in many parts of the country. A properly designed and constructed mound is an excellent onsite sewage treatment system. You most likely have learned about the design features of mounds during your training.

The mound must be located in the area specified by the site evaluator. As with any onsite system, the area for the mound must be staked in the field for the installer's information.

The first step in mound construction is preparation of the soil surface. Vegetation must be removed and the surface of the soil scarified. Never let an installer use a tiller on the ground surface. The soil structure will be destroyed and the mound will fail.

The proper time to check the installation of a mound is when the soil is being prepared. Ask the installer to let you know when the ground surface will be prepared for the mound. Make your inspection at that time, since proper surface soil preparation is critical to the success of a mound.

The sand used in a mound

must be clean and include little fine material, such as silt or clay. Get to know the origin of the sand and check for silt and clay. Put about 2 1/2 inches of sand in a fruit jar and add water to three-fourths full. Shake well and let stand for several minutes. If there is a layer of silt or clay on top of the sand more than 1/4-inch thick, the sand has too many fine particles. A biomat will form on top of the sand layer and the mound will fail. That sand must not be used under the rock layer of the mound.

Heavy equipment with wheels must not be allowed in the mound area. Such traffic will compact the soil under the mound. The sand must be dumped on the side of the prepared surface area and the sand layer pushed into place with a track-type tractor. At least 12 inches of sand should be under the tracks at all times to protect the original soil surface. The rock layer must be placed with a backhoe bucket or similar equipment to ensure no heavy equipment operates on the mound.

The pressure distribution laterals of the mound should be checked to be sure that the holes are properly drilled and clean. You can use your "book learning" to check the size and spacing of the perforations.

Some mounds use gravelless trenches instead of a rock layer. A pressure distribution lateral must be installed the length of each gravelless trench. Do not allow gravity distribution in any mound.

Readers are welcome to submit questions to the Answer Man. Send your question to COLE Publishing by e-mail to editor@pumper.com, by fax to 715/546-3786; or by mail to P.O. Box 220, Three Lakes, WI 54562. We will pass your question along to Dr. Machmeier.



Never let an installer use a tiller on the ground surface. The soil structure will be destroyed and the mound will fail.

Use "book learning" to check that the mound dikes and side slopes are proper. A side slope of three horizontal to one vertical is maximum steepness. A dike side slope of 4:1 is much better and easier to mow. The finished mound should have grass cover established by the installer.

Pressure distribution requires a dosing tank and pump station. Be sure the wiring is connected properly and an alarm indicates a pump failure. An inspector qualified in electrical systems must make this type of inspection.

Both the sewage tank and the dosing tank will have manholes. The sewage tank manhole is for removing accumulated solids from that tank on a regular schedule. The pumping tank manhole is for servicing the pump and controls.

Easy manhole access is desirable for both services. Safety is an issue, and the manhole cover must be locked or otherwise so secure that only an authorized person can get access to the tank.

Many sanitary codes now specify that manhole covers of sewage tanks and dosing stations can be brought to the ground surface. If this is done, the manhole cover must have a locking device to prevent unauthorized entry. Check the manhole covers on all sewage tanks and dosing stations to see if they meet specifications.

You will need to make a final inspection on the completed installation. The installer will want to set a schedule and time for that. However, it is a good idea to "drop in" for an inspection as systems are being installed. That is the best way to check for possible code violations.

When you find installers who always follow proper procedures, you won't need to check their work as often. The few installers you find following incorrect procedures will need more unannounced inspections.

If you continue to make unannounced inspections, you will generally find fewer mistakes will be made.

Remember, you are working for the future owner of the onsite sewage treatment system to make sure a proper system is installed. Responsible installers have the same goal.

Follow your sanitary code on all major items. If you require an installer to change some construction feature, be sure you have a statement in the code to back up your request. Also, be sure there is a logical reason for the provision.

Good luck on your new job. Using common sense and working with your installers will make your work go a lot easier. It will also go a long way toward having proper onsite sewage treatment systems installed in your area. ■

PolyPortables' POWERTRIC

NEW!
Turbo Tabs now in water soluble packets
1st & 2nd Gears are ideal for Fall Events & Winter
Call for Introductory Price



CHOOSE FROM THREE OF THE INDUSTRY'S MOST POWERFUL RESTROOM DEODORANTS

TURBO TABS

- Self mixing tablet dissolves completely in seconds
- Ounce for ounce the strongest tablets you can buy
- Water soluble individually wrapped packets

TURBO TUBES

- Portion-controlled liquid
- Pure concentrate, no water added
- Convenient tear-top packaging

BLUE WORKS 150

- Ultra concentrated formula
- Highest level of fragrance and non-staining blue dye
- Superior odor-fighting technology

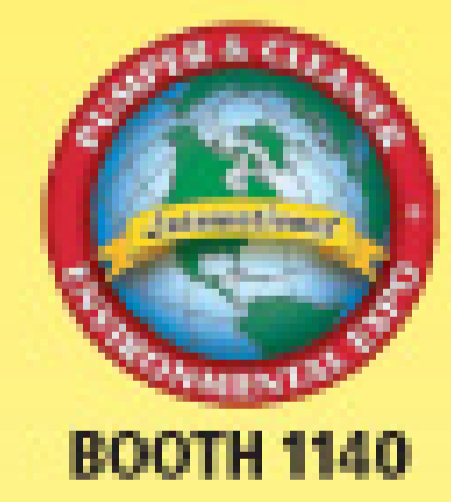

See for yourself. Try a FREE sample. Call Cindy or your PolyPortables regional manager at 800-241-7951



POLYPORTABLES

Listening. Learning. Delivering. Since 1972

99 Crafton Drive, Dahlonega, GA 30533 USA • Phone (800)241-7951 or (706)864-3776 • Fax (706)864-8111 • www.polyportables.com

Only PolyPortables offers high-performance Green Way Products

RESTROOM DEODORIZERS • RESTROOM CLEANERS • AIR FRESHENERS • INSECT REPELLANT

All Green Way deodorizers, cleaners and air fresheners are earth-friendly, people-friendly products. They are developed and manufactured in our facilities in Dahlonega, Georgia by Green Way Products, a PolyPortables sister company.



Green Way Products
solutions for life

REVOLUTIONIZE your pump

With the new, advanced vane pump blades from AIC:
DuraBlade™



AIC's new DuraBlade increases run-time between maintenance. A better blade really can make your pump run longer without effecting critical components!

- Fabricated to exact tolerances
- Specially heat treated
- Operates at lower temperatures
- Produces less friction
- Increased stability and resistance to warpage

DECREASE DOWN TIME & SAVE MONEY!

Join the revolution for better pump performance — call AIC today!



811 Industrial Loop
Breckenridge, TX 76424
Toll-free: 800-272-7557
Fax: 254-559-7550
www.aicdover.com



LEADER IN ONSITE SOLUTIONS



FULL LINE OF PRODUCTS
FOR RESIDENTIAL AND
COMMERCIAL APPLICATION.



CALL US FOR MORE INFORMATION.

 **Delta Environmental
Products™**
Pentair Water

800-219-9183
www.deltaenvironmental.com



Booth 21002

Specializing in Truck Mounted Jetters • Port-O-Let Trucks • 2 Compartment Trucks • Roll-Offs • 500-5000 Gallon Units Available

Specializing in Truck Mounted Jetters • Port-O-Let Trucks • 2 Compartment Trucks • Roll-Offs • 500-5000 Gallon Units Available

QUALITY

TANK TRUCKS & EQUIPMENT

3301 E. Moore Ave • Indianapolis, IN 46201 • office: 317-635-0000 • fax: 317-635-9588
toll-free: 877-636-0001 • www.qualitytanktrucks.net

WE CUSTOM BUILD HYDRAULIC TANK TRUCKS TO YOUR COMPLETE SPECIFICATIONS



▲ *Built for Scott Rowe Septic*
2600 gallon full open rear door dump



▲ *Built for Erichell Septic*
4200 gallon stainless



Booth 4006-4007, 4009

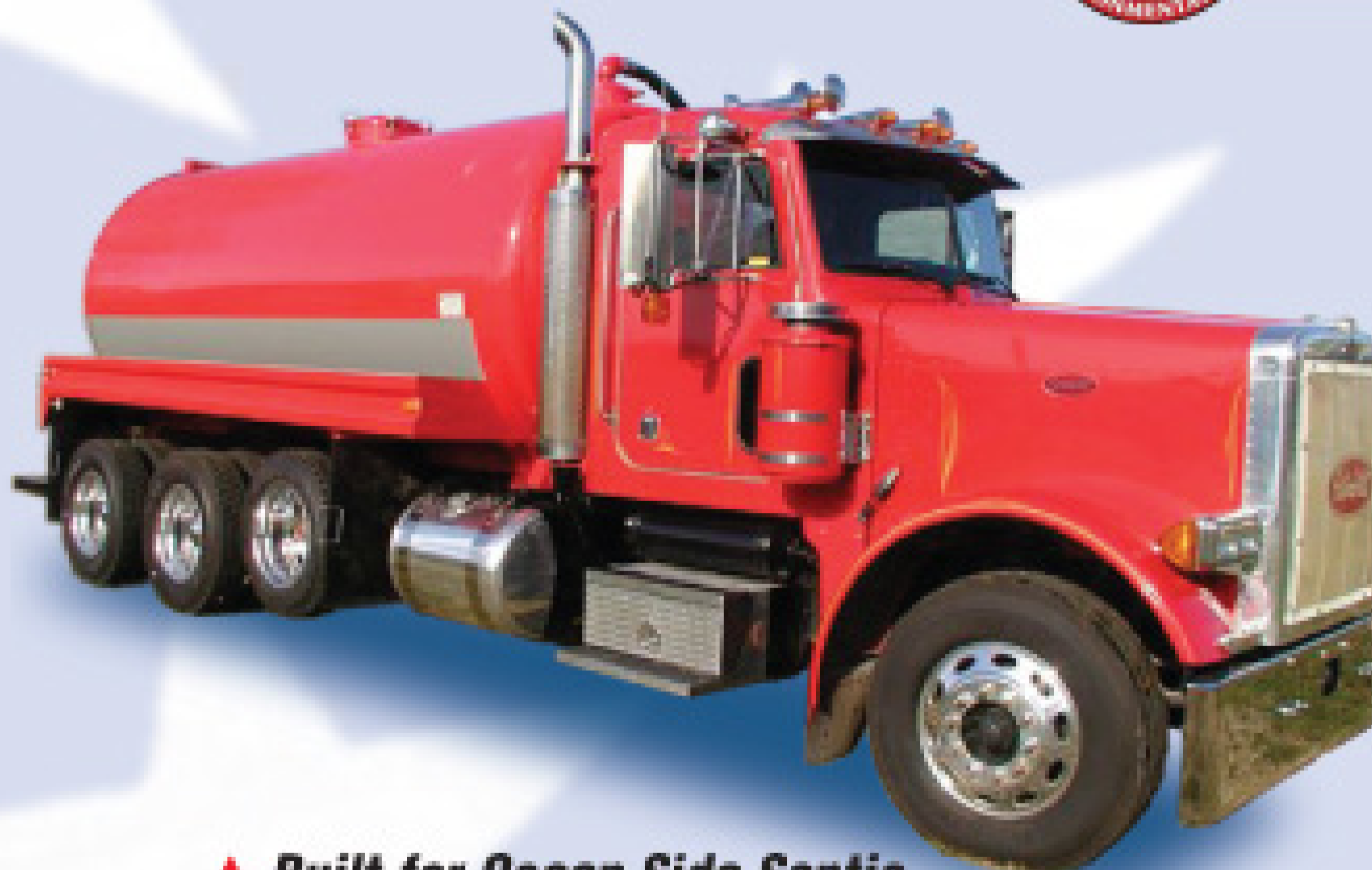

▲ *Built for Ocean Side Septic*
2003 Peterbilt 4200 gallon tank



▲ *Thanks to Tom and Pat at Metro Rooter for this custom built trailer that they engineered and designed*

QUALITY IS AN AUTHORIZED REPRESENTATIVE FOR:



Specialized financing:
* *North Star Commercial Credit.*
Call Tom Myers: (877) 804-2274

TIGERFLEX™



Tiger™ Green/Tiger™ Yellow/Tiger™ - SD

- Superior EPDM compounds - longer life; more durable; superior chemical resistance.
- Superior Flexibility - 22% more flexible! Easier to handle off trucks, especially in cold weather!
- UV and weather resistant exterior.
- Specially designed abrasion-resistant helix – slides over and around objects; easier to handle and work with.
- Tiger™-SD – reinforced for both suction & pressure discharge applications.

Applications:

- Septic handling
- Liquid and dry chemical & fertilizers
- Sewer cleaning water jetting leader hose
- Construction



Kuriyama of America, Inc.

360 E State Parkway | Schaumburg, IL 60173 | fax: 847.885.0996
847.755.0360 | email: sales@kuriyama.com | www.kuriyama.com



Booth 32

7000 Gallon Aluminum



Manufacturing

- Stainless Steel
- Aluminum
- Code & Non-Code

800-589-5254

ACRO

Trailer Company

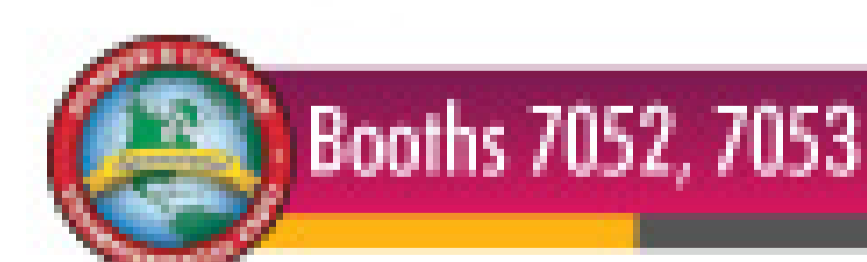

Vacuum Trailers for the
Liquid Transportation Industry
Parts • Repair • Complete Pumping Systems

www.acrotrailer.com • 417.862.1758 • fax 417.862.8084 • 2320 North Packer Road • Springfield, Missouri 65803

GapVax®



See us in Louisville!
Booth #1022 at the Pumper Expo



888-442-7829

www.gapvax.com

Industrial Vacuum Trucks Combination JetVac Trucks
Hydro-Excavators Specialty Units Cyclone Trailers
Skid Units Autoloaders

THE NEW GENERATION

Longer life, Easier Installation, Lower Operating Costs



VF Series

Flow: 3-6 GPM
Pressure: 11600-21750 PSI
50 EBHP



MK Series

Flow: 40-62 GPM
Pressure: 3625-5800 PSI
160 EBHP



KE Series

Flow: 8-18 GPM
Pressure: 1885-4350 PSI
25 EBHP



MK Series

Flow: 75-1078 GPM
Pressure: 2175-2900 PSI
160 EBHP



KF Series

Flow: 24-45 GPM
Pressure: 1600-3045 PSI
50 EBHP



HF Series

Flow: 8-19 GPM
Pressure: 4060-8700 PSI
50 EBHP



KS Series

Flow: 24-60 GPM
Pressure: 2000-3625 PSI
75 EBHP



Booth 8041

General Pump

1174 Northland Drive Mendota Heights, MN 55120
651.686.2199 Fax: 651.454.8015 email: sales@gpcompanies.com
www.generalpump.com

CUSTOM SIGNS AND DECALS



877-340-0004
800-638-1233



TROUGH PORTABLE SERVICES
1-800-740-7400

Another...
ANDY GUMP FENCE
1-888-263-9486

Diamond
1-888-744-7191

NATIONAL RENT-A-FENCE
1-800-352-3475

HAULAWAY
800-222-3337
haulaway.com

All Of Our Custom Manufactured Products Are Quality Engineered For Long Term Outdoor Durability.

- Very Competitive Pricing
 - Knowledgeable, Helpful And Courteous Customer Service Staff.
 - Dependable Delivery.
 - Digital Print And Vinyl Cut Lettering
 - Generic Signs And Decals
- And Much More!



Booth 20043

DURABLE, AFFORDABLE AND BUILT TO LAST
SINCE 1949

J.C. Gury Company Inc.

530 East Jamie Ave, La Habra, CA 90631 Call (800) 903-3385 or (800) 556-5576
www.jcgury.com

Clearly,
A Good Idea!



NU CONCEPTS

Solar Powered, Self-Contained,
Special Event Restrooms

www.nuconcepts.com

800-334-1065



Booth 8191

ENGINE & ACCESSORY, INC.

Toll-Free: 1.800.327.5431

Tel: 305.573.2268

Fx: 305.576.4617

www.eamfg.com



Booth 5127A

Engine & Accessory is your one stop shop for all of your vacuum truck needs. Delivering the best possible customer experience.

Benefits include:

- **ISP Program - In stock tank and truck program**
- **Direct access to all major chassis manufacturers**
- **State of the art manufacturing facility complete with service shop**
- **Extensive parts inventory and complete product support**
- **Full engineering capabilities using the latest technology**
- **Knowledgeable sales staff**
- **Customizable units with a broad range of options**
- **Nationwide product delivery**
- **Complete package of financing and lease options**



2007 Ford F750 - 2000 gallon tank (1500/500) - Low work station - Masport pump system - Several Available

Several Pre-Emission Units Available



2007 Isuzu NQR - 1250 gallon tank (900/350) - Low work station - Masport pump system - Several Available

Several Pre-Emission Units Available

Many 2007 Pre-emission Fords and Isuzus available for Portable Restroom Service Units.



Aluminum vacuum trucks. Sizes range from 2000-5500 gallons with many pumping system options available.

Call Today!



Spec your Industrial Unit. Options for Hoist and Full open rear doors. DOT Code and Non Code.

Call Today!



Steel vacuum trucks. Sizes range from 2000 - 4000 gallons with many pumping system options available.

Call Today!



Combination pumper designed for servicing portable restrooms as well as septic tanks.

Spec Yours Today!



Classy Truck
of the Month

Join The Rooter-Man Team
WWW.ROOTERMAN.COM
ROOTER-MAN
"To The Rescue"
 Booth 9115, Truck Space TR-9015
AS SEEN ON TV
New Concept In Franchising
NO ROYALTY ON PERCENTAGE OF SALES BASED ON POPULATION
Exclusive Territories Available
Reserve your Territory, Call 1-800-700-8062
FRANCHISE PACKAGE \$7,950.

Goodwin Septic Cleaning
 Wisconsin Rapids, Wis.

This bright white and red 2007 International 7500 is the latest pumping rig of Goodwin owners John and Jody Banta. The truck was built out by T-Line Equipment Inc. and outfitted with a 3,600-gallon steel tank with epoxy lining and an NVE 506 liquid-cooled pump. The service vehicle is powered by an HT570 310-hp International engine with 1,050 ft./lbs. of torque, coupled with an Allison 3000 Rugged Duty Series automatic transmission. It also sports convenience features including air-ride suspension with dump valve, heated valves to perform flawlessly in cold, northern winters, stainless-steel hose trays and three aluminum diamond-plate tool boxes. The good looks on the outside are completed with Accu-Ride polished aluminum wheels, stainless tailboard and bumper, and graphics by Steve Livernash of Artistic Sign Co. Interior comfort features include A/C, cruise control, air-ride cab and seat, and premium stereo with CD. The truck is used primarily for residential septic and holding tank pumping.

Show us yours!

Got a truck with real WOW appeal? Show it off to Pumper readers — and to the whole world through www.pumper.com!
 Send photos of your truck after it has been lettered with your company name, and please pose the owner(s) with the truck. Any industry-related truck is acceptable. Please limit your submission to one truck only.
 Your submission must include your name, company name, mailing address, phone number, and details about the truck, including tank size, cab/chassis information, pump information, the company that built the truck, and any other details you consider important. In particular, tell us what features of the truck help make your work life more efficient and more profitable. E-mail your materials to editor@pumper.com or mail to Editor, Pumper, P.O. Box 220, Three Lakes WI 54562. We look forward to hearing from you!

Batting clean-up for 100 years

Register to win this
Stan Musial bat!



Booth 5181A



When you want the best on your team, you need proven players. That's why customers ask for Gardner Denver's Wittig line of vacuum pumps by name.

Designed specifically for the tractor and trailer mounted liquid vacuum pump market, the Wittig RF Series is a heavy hitting MVP that will always step up to the plate and deliver. With its superior quality, unmatched performance, and long lasting durability, the Wittig line is a seasoned pro that's worth the investment.



Check them out. Ask around. Then give us a call. We'll be glad to show you what separates the Wittig pump from the rookies.

Ask about our special anniversary pricing!



1-800-626-6334

www.gardnerdenverproducts.com

10280 Brecksville Road Brecksville, Ohio 44141



R.A. ROSS N.E., INC.

INDUSTRIAL & TRUCKING BLOWERS • VACUUM PUMPS • SALES, SERVICE, & INSTALLATION



We have a **FULL SERVICE REPAIR SHOP** capable of servicing and repairing a wide variety of different makes and models of blowers and vacuum pumps from all your top manufacturers including
**Tuthill/MD • Drum • Gardner Denver • Cycloblower • Duroflow • Sutorbilt • Roots • Hibon
 Fruitland • Moro • Masport • Wittig • NVE Challenger • Jurop • Battioni • Presvac
 Blackmer • Roper • Ranger • Viking**

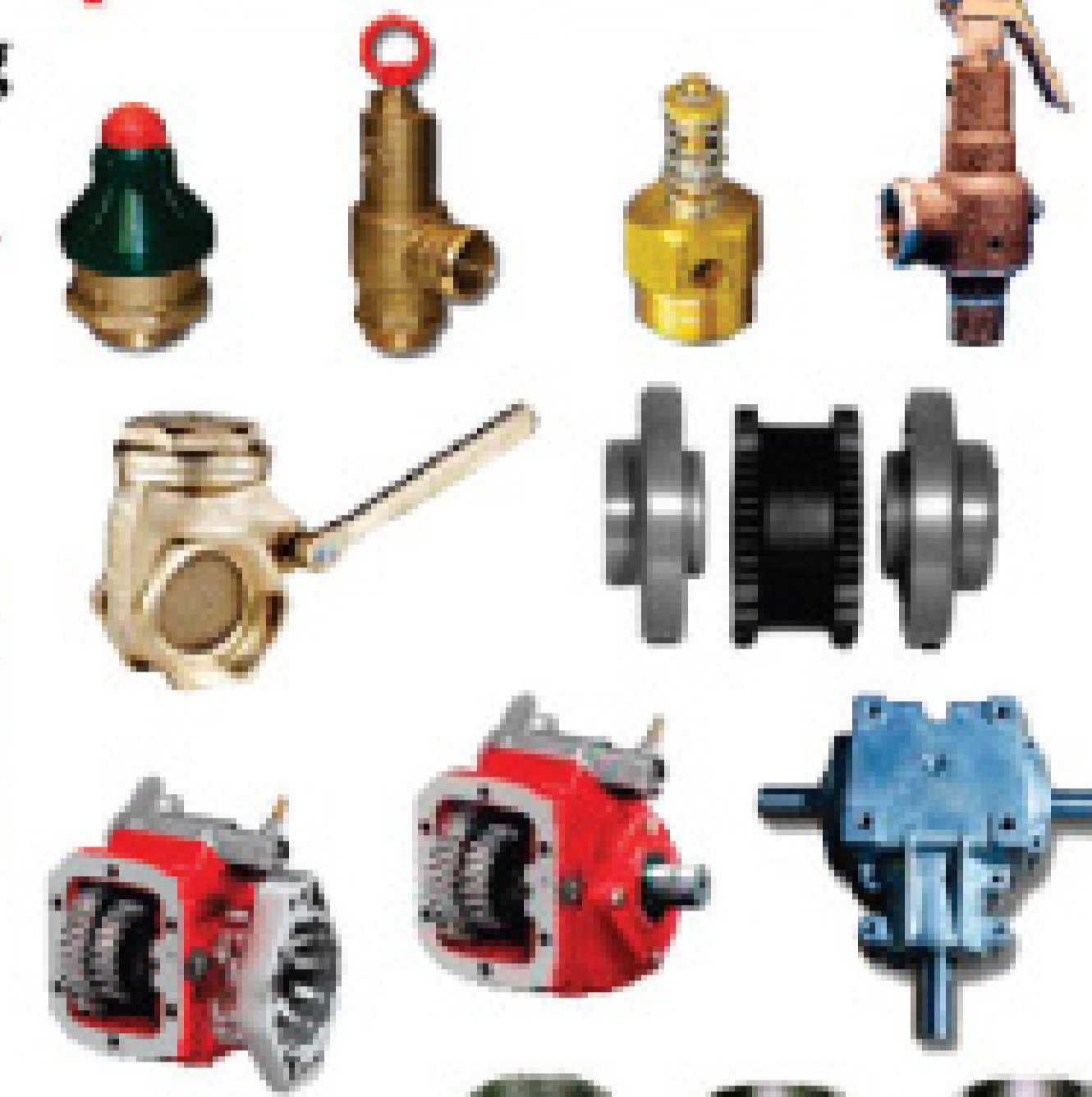

NVE FRUITLAND CHELSEA®
A DIVISION OF Parker



Vacuum Pumps • Components • PTO's • Hydraulics • Valves • Manways • Gear Boxes • Mufflers • Silencers • Gauges • Camlocks • Hose

TOLL FREE 1.800.678.4581 PHONE 440.546.1190 FAX 440.546.1188 EMAIL RAROSSNE@RAROSSNE.COM WEBSITE WWW.RAROSSNE.COM

Save Time! Save Money! With a Stellar Hooklift!



- One truck can support numerous bodies, which cuts cost and maintenance
- Over 40 models available, capacities up to 65,000 lbs.
- One truck operator can, without leaving the cab of the truck, load and unload or change truck beds in less than a one minute cycle
- Patented dump/load interlock system
- Gravity type safety latches are used to prevent accidental detachment of the body
- Rugged rear body tie-downs and large over-sized rear hinge pins to insure stability
- Low maintenance
- Unlimited uses



The Stellar Hooklift Interchange System...Explore the Possibilities!



STELLAR® Our People. Our Products.
 INDUSTRIES INC. 800-321-3741 • www.stellarindustries.com

T **RANSWAY** *SYSTEMS INC.* **PROFESSIONAL VACUUM EQUIPMENT**

Toll-Free: 800-263-4508

DELIVERY SERVICE
AVAILABLE

T: 905-578-1000

F: 905-561-9176

314 Lake Ave. North
Hamilton, Ontario L8E 3A2

WE PAY BORDER CROSSING CHARGES • LEASING? WE CAN REFER YOU TO THE SPECIALISTS • OVER 40 YEARS IN BUSINESS

HEAVY-DUTY EQUIPMENT THAT WORKS!

**LET 45 YEARS
OF EXPERIENCE
WORK FOR YOU !**



Booths 4198-4199



**MUNICIPAL &
INDUSTRIAL
TRUCKS**



**SEPTIC
TRUCKS**



**TOILET
TRUCKS**



**ALUMINUM
TANK TRUCKS**



PORTABLE TOILET
SERVICE UNITS
SLIDE IN UNITS
HOISTED UNITS
ROLL OFF UNITS
CUSTOM UNITS

www.pikrite.com

Do Your Shopping At Pik Rite and Save



pikrite

Manufacturing & Sales - 60 Pik Rite Lane - Lewisburg, PA 17837

1-800-326-9763



#4202-4205, 4207, 4208

LIBERTY PUMPS



Omnivore LSG 200
Residential Grinder

We Carry a Full Line of
LIBERTY PUMPS
which come with a
2-year warranty



280-Series Mid-Range
Effluent Pump

Regenair 
R3105-12
Blower
\$410

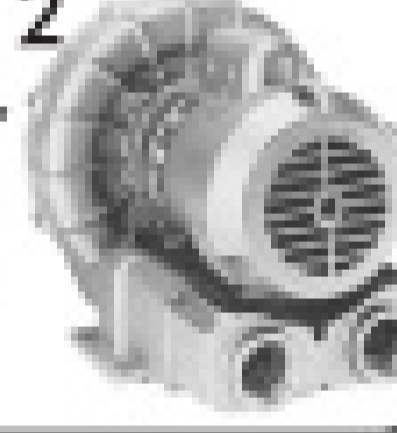

**Hydromatic,
Zoeller, ABS,
Liberty &
Myers
Pumps**

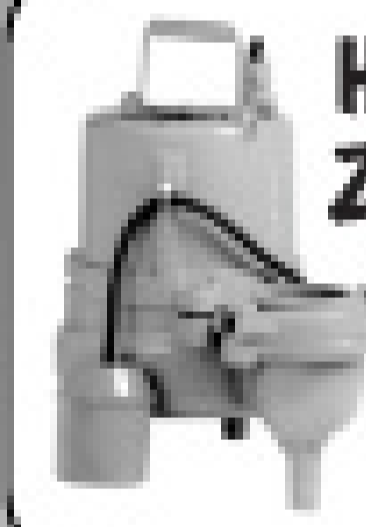

**Sutorbilt & Roots
Blowers**



SDS 
From 70-180 cfm



Heavy-Duty
DC-STAINLESS
Washdown Pump



**Moro PM80
Turbo 350 cfm**



**Moro
M3
176 cfm**



**Moro
M-10
230 cfm**



Moro Pumps: from 176 to 1642 cfm

Flagg-Air Model 340

\$325

- 3450 rpm
- 1/4 hp, 115V
- Enclosed motor
- Stainless steel shaft
- High impact plastic parts
- Operates quietly
- 2-yr. warranty
- Fits in place of most original manufacturers' units
- Replacement parts available

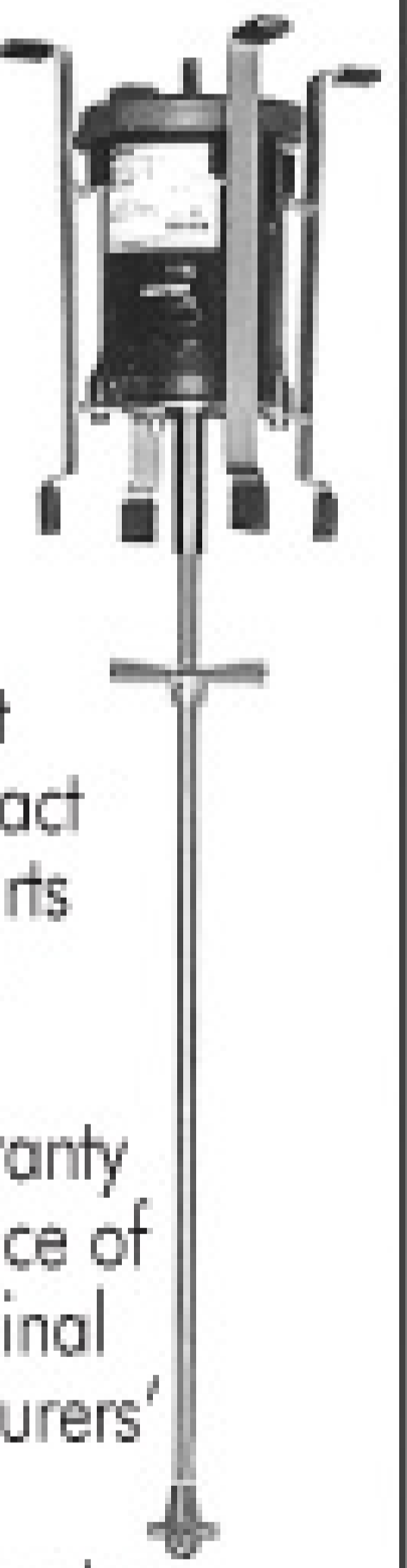

The Flagg-Air 340 does not carry the NSF seal. Check local and state regulations for approval in your area.

Stop by and
see us at the
Louisville Show!



Booth 6097

**MEDO
Piston**

LA-60B \$275
LA-80B \$300
LA-100B \$445

SECOH Diaphragm

EL 60 \$255
EL 80 \$300

0523
Rotary Vane
Compressor
\$310



Septic Services, Inc. toll free 1.800.536.5564 • 636.583.5564 • fax 636.583.6432
e-mail septic@fidnet.com • web www.septicserv.com



Zoeller searched the globe for proven wastewater technology

Introducing **FUSION** Treatment Systems

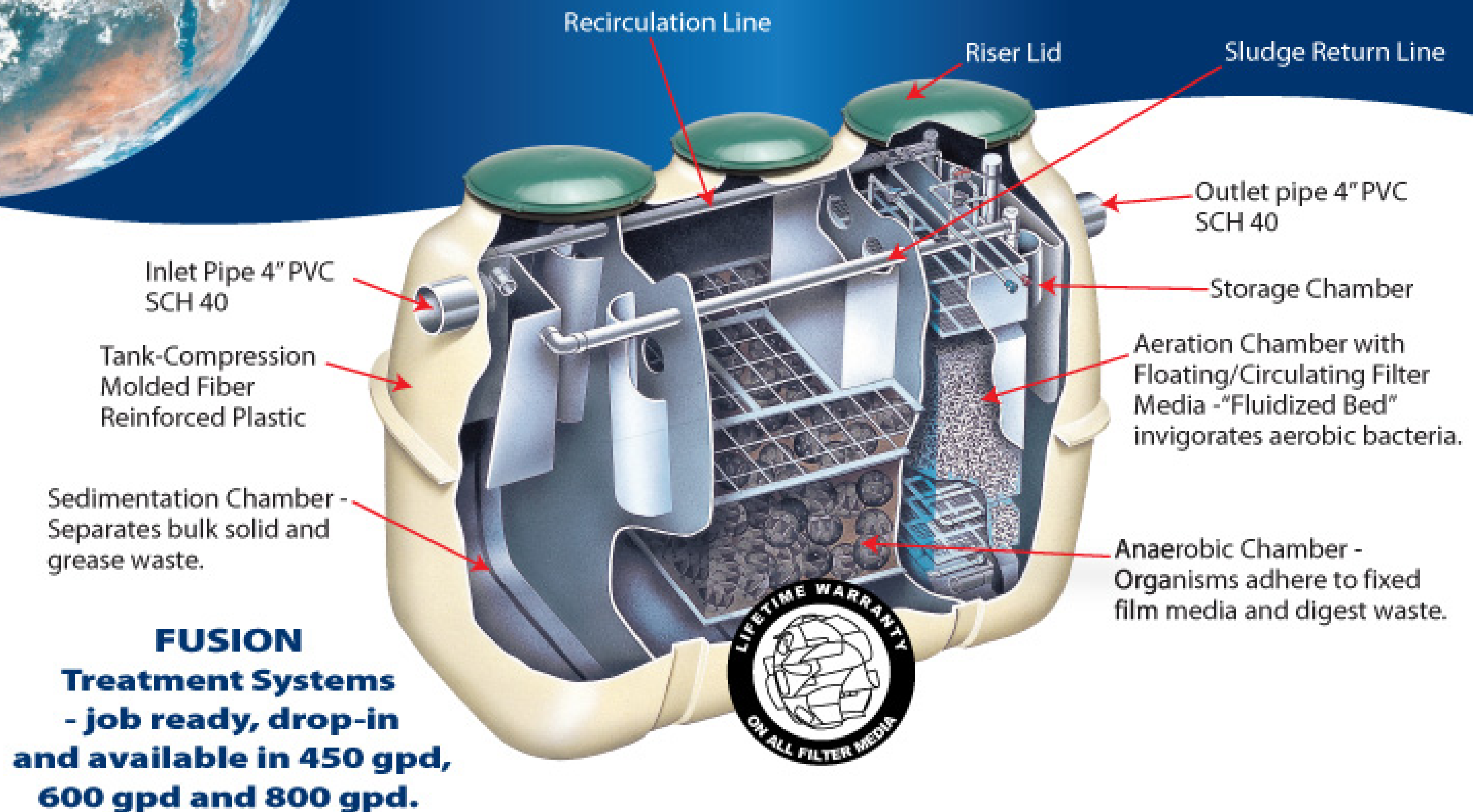

Zoeller brings innovative technology to the American onsite wastewater market. FUSION Treatment Systems are fully assembled, compact, efficient and reliable. Designed for a wide range of residential applications, every system is backed by Zoeller's exceptional service and maintenance standards.



Booth 87

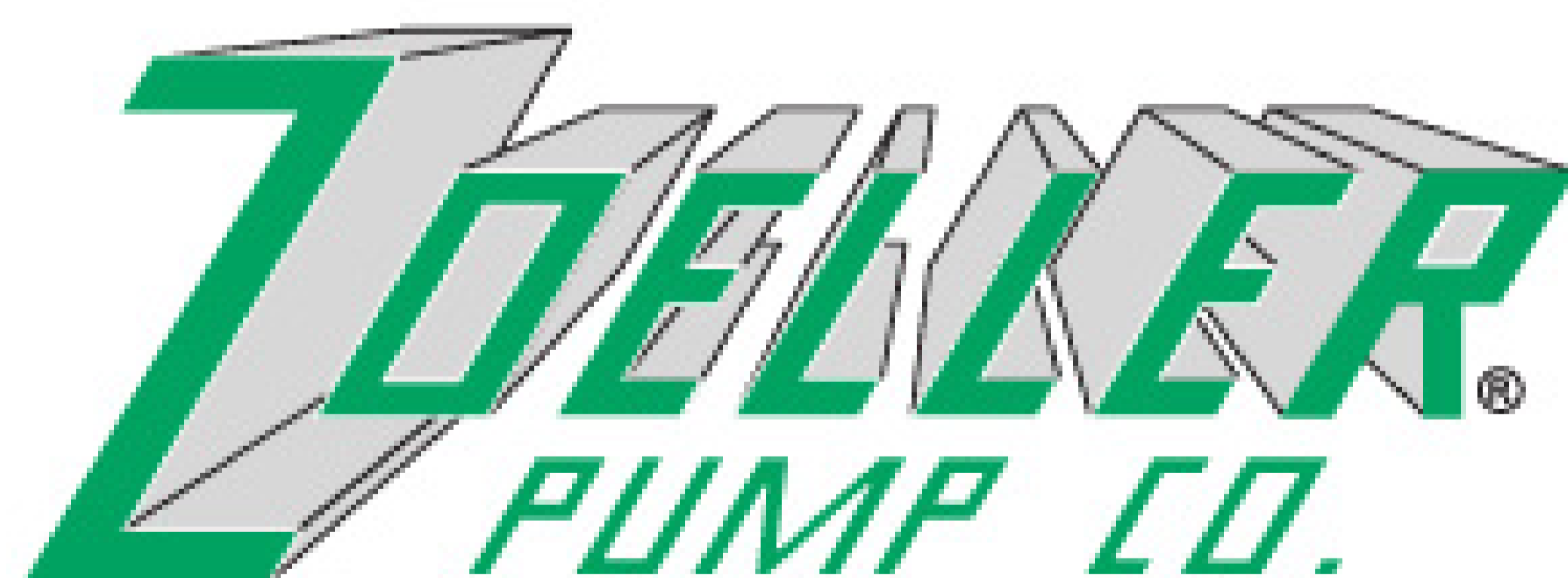

Extensive line. Since 1939

The Fusion Series Treatment Systems are a Zoeller Pump Company and Fuji Clean Co., Ltd. collaboration.

- Effluent Pumps • Effluent Filters • Filter Step Systems
- Z-Cell Systems • Fusion Series Systems • Recirculating Media Filters
- Decentralized Wastewater Systems • Accessories and Controls

Zoeller Pump Company • 3649 Cane Run Rd. • Louisville, KY 40211 • 502-778-2731 • fax 502-774-3624

Call or visit
800-928-7867
www.zoeller.com

Don't Go In Without The BLUE



DEEP BLUE™

A Complete Odor Control & Cleaning Program
from Nilodor®, Inc.

- Additives
- Super Concentrates
- Deodorizers
- Cleaners
- Graffiti Remover
- Hand Sanitizer
- Hand Soap



Booth 4220



Controlling Unwanted Odors For Over 50 Years

NILOdor® Inc.

P.O. Box 660 Bolivar, Ohio 44612

800-443-4321

www.getdeepblue.com

Vacuum Pipe



Vacuum Fittings



Booth 7220

Aluminum Camlocks

Consolidated Pipe & Tube Co., Inc.

Fittings Flanges Hose Pipe Valves

Custom Fitting Fabrication
Ph: (806) 763-9591

Kwikk~Lokk Coupling Distributor
karl@vacpumperparts.com

www.vacpumperparts.com

LAXI TAXI



- No Straps Needed
- Positive Action Clamps
- Easy to Load & Unload
- Financing Available
- Tows Easily on Highway
- Torsion Bars Suspension
- Trailers for 4 to 20 units



F.M. Manufacturing
(877) 889-2246
sales@fmmfg.com

www.fmmfg.com



IN STOCK! *Septic/Grease Trap & Restroom Service Trucks*

Contact: Jeff Hurst 800-692-5844 email: jhurst@west-mark.com
 www.west-mark.com Tel: 209-537-4747 / Fax: 209-537-1753 / 2704 Railroad Ave, Ceres, CA 95307

NEW! 2008 Sterling Bullet - 20,500 GVW



#5021 & 6021

Cummins 6.7 Liter Turbo Diesel 305 HP
 Automatic trans, 7,000 lb. 13,500 lb. Axles,
 Exhaust Brake, AC, AM/FM-CD, Cruise.
1500 Gallon PORTA VAC
 Masport HXL4 -1100 Waste / 400 Fresh,
 Burks washdown / Hot Shift P.T.O.

\$66,400

Lease from **\$1328.** mo
 4 Wheel Drive ... \$71,495

NEW! 2008 Kenworth T300 - 22,000 GVW

Cummins diesel, Allison automatic, Hydraulic brakes,
 Air Conditioned, AM/FM, air suspension drivers seat,
1700 Gallon PORTA VAC
 400 fresh / 1300 waste. Masport HXL 4 Vac pump
 with pre-filter, Burks DC 10 wash down,
 Hot shift PTO w/ remote 4" Discharge,
 Unit hauler and tow package.

\$73,900 Lease from **\$940.** mo.



NEW! 2008 International MaxForce 25,999 GVW

4300 Series MaxForce, **215HP M7 V8 diesel**,
 560 ft.lb. torque Allison 2100 RDS auto trans, air brakes,
 10,000 lb front, tilt wheel, AM/FM, vertical pipe, AC...more!
2000 Gallon PORTA VAC Restroom Service
 500 fresh / 1500 waste
 Masport HXL 4 w/ pre-filter, Burks wash down,
 Hot shift PTO w/remote ,4" Discharge,
 Unit hauler and tow package.

\$76,500 Lease from **\$1524.** mo.



PRO Condor VAC

INDUSTRIAL PUMPOUT STATION

There is no substitute for professional pumping equipment

- Ideal for grease trap pumping
- Extremely maneuverable, can go just about anywhere
- Pumps fast, 60 GPM, 60 gal. capacity
- Will not blow 15 amp breakers
- Will not overflow
- Has odor control technology
- Comes complete with everything needed for pumping
- Factory direct with factory support

Call today for complete information and specifications on the industries' most complete portable pumpout unit.

Toll Free 800-367-0972

Westmoor Ltd.

P.O. Box 99
Sherrill, New York 13461

NOW 30% More Power!



Booth 8109

On The Web At: www.westmoorltd.com, e-mail: pumps@westmoorltd.com

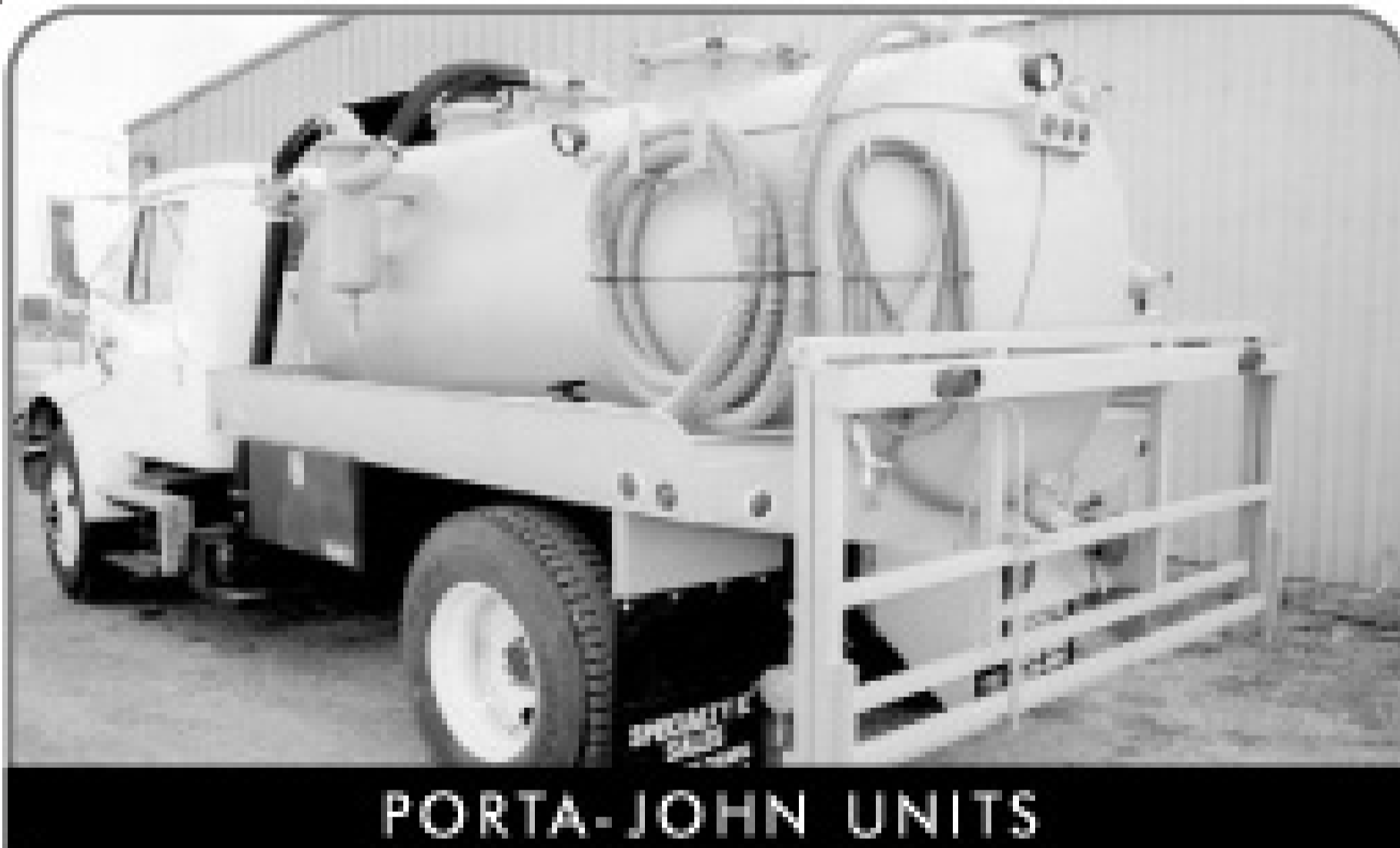

PORTA-JOHN UNITS



STAINLESS STEEL & STEEL UNITS - CALL FOR INFORMATION



TANKS MANUFACTURED TO YOUR SPECIFICATIONS

PUMP DISTRIBUTOR

- * BATTIONI
- * JUROP
- * BOWIE
- * MASPORT
- * FRUITLAND
- * MORO

Pump Rebuild Kits In Stock

CALL TODAY FOR INFORMATION OR PRICES ON TANKS, PUMPS AND ALL PARTS

Secondary Shutoffs

Sight Glasses, Valves & Couplings

12" Primary Shutoffs

21" & 36" Manways

BASE TANKS INCLUDE:

1/4" Thick Steel • Pipe Reinforced Baffles • Primary Shutoff Flanged and Dished Heads • 21" Top and Rear Hatches Full Length Under Carriage on Bottom of Tank

BASE TANK PRICING

2100 GALLON.....	\$5800	3360 GALLON.....	\$8380
2500 GALLON.....	\$6690	3570 GALLON.....	\$8900
3000 GALLON.....	\$7350	4000 GALLON.....	\$9880

800.364.7307 | 2100 EAST BOOTH ST. • SEARCY, AR 72143
Fax: 501.279.0003 • E-mail: sbs@cdlworld.net



TUF-TITE®



Booth 1218

For Samples & Pricing
Call: 800-382-7009

Septic Tank Riser, Lid & Safety Pan™

FREE FREIGHT ON FULL CARTONS!

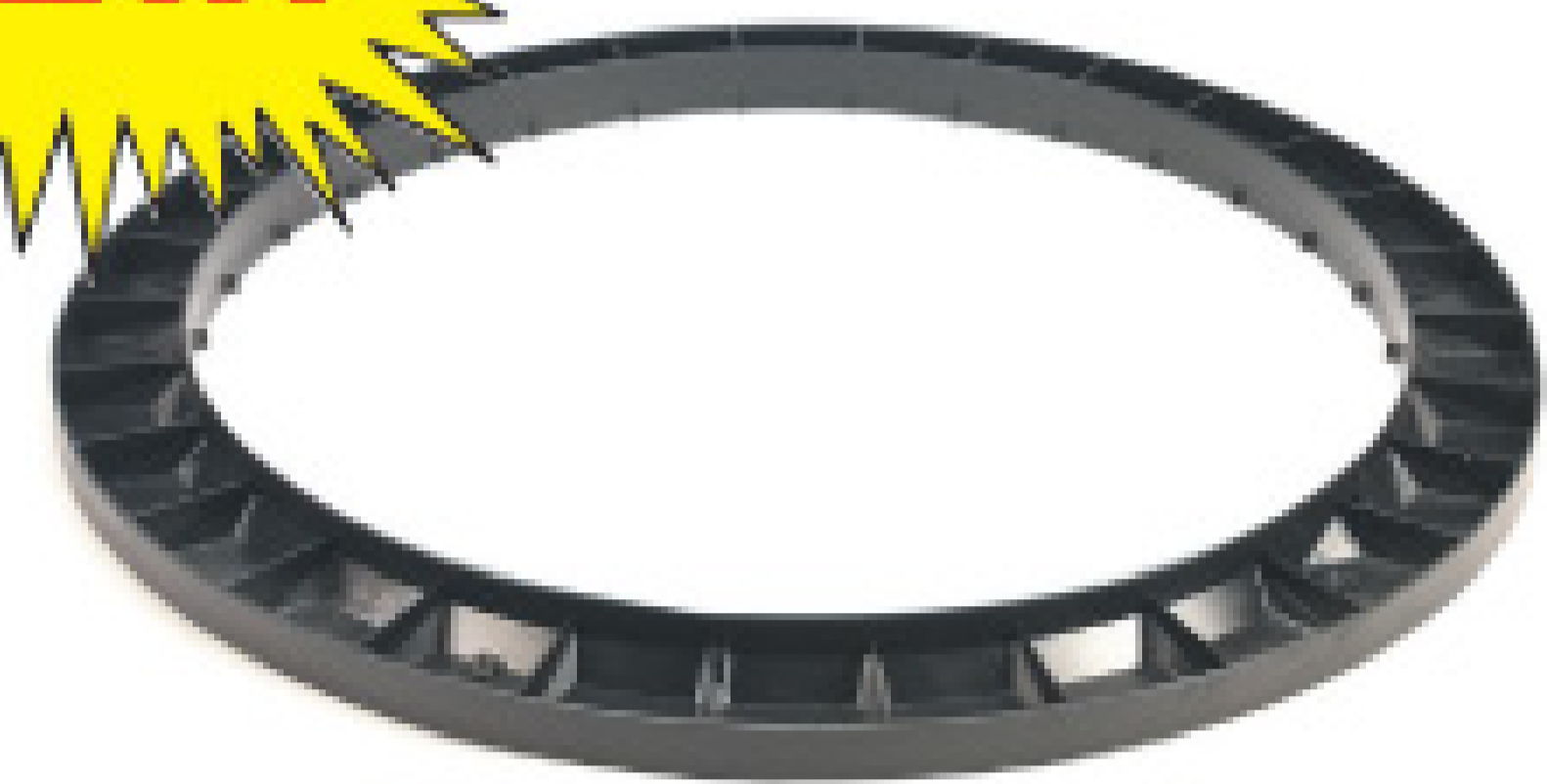
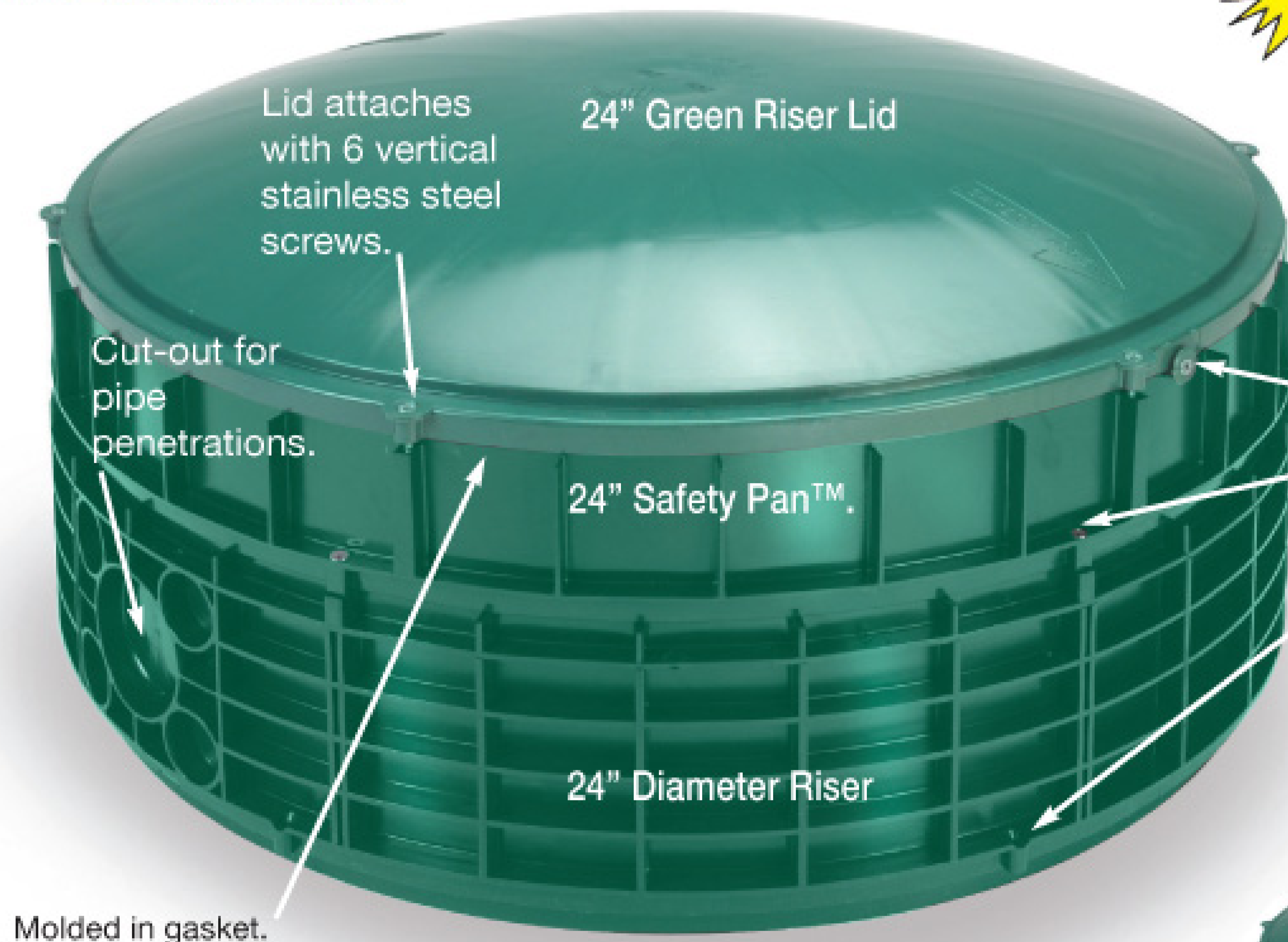

Tank Adapter Ring

New - Horizontal Safety Screw.

Safety Pan™ to Riser attachment with 6 vertical stainless steel screws.

Riser to Riser attachment with 6 vertical stainless steel screws.

Patent Numbers
5,617,679 &
5,852,901; other
pats. pending.

Riser Lid

with Molded-in gasket.
Available in 12", 16", 20" and 24" diameters.

Concrete Lid w/handle

Safety Pan™

Safety Pan™ available in 16", 20" and 24" diameters.

Riser

For septic tanks. Stackable in 6" increments. Available in 12", 16", 20" and 24" diameters.

Tank Adapter Ring

For mounting riser flush to top of tank when casting-in is not an option.

Available in 12", 16", 20" and 24" diameters.

Effluent Filters

Patent Numbers
6,319,403; D 431,629; other
pats. pending.

800 GPD
ANSI/NSF
Standard 46

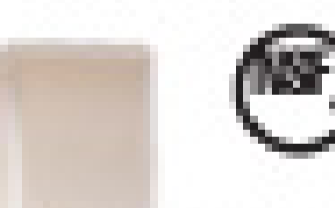

4" Sch. 40 & SDR-35

EF-4
4" Filter

EF-6
6" Filter



One-Piece Tank Seal

For concrete Septic tanks and D-boxes. Accepts pipes from 1-1/2" to 4". Mounts with or without concrete flash.



TS-4-RUBBER TANK SEAL
(will hold 10psi)
TS-4PRO TANK SEAL
(will hold 5" vacuum)

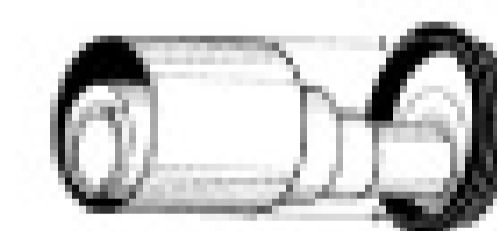

Free Freight: 32¢

Patent No's
4,951,914,
5,624,123
& 5,711,536;

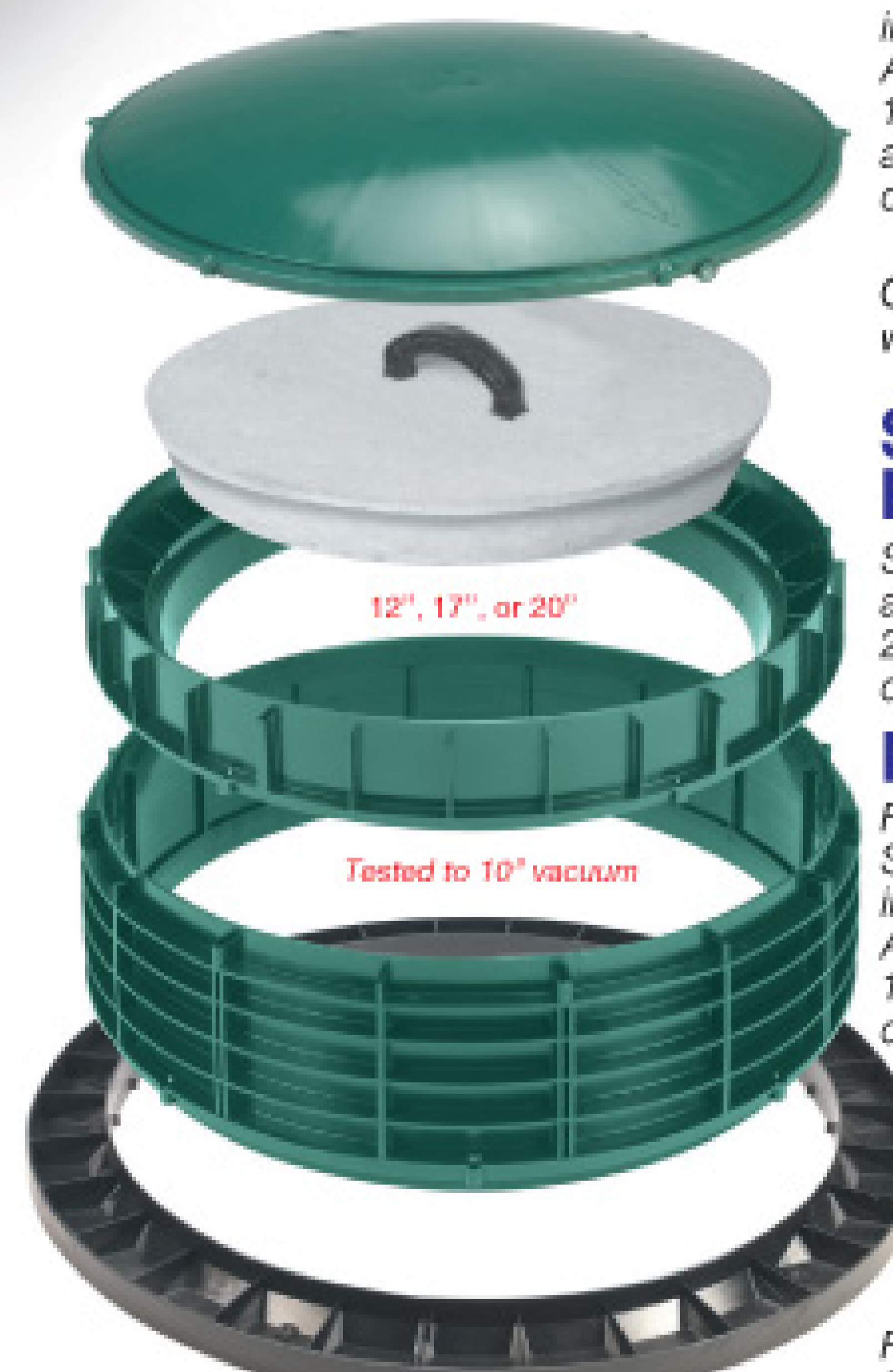

12", 17", or 20"

Tested to 10" vacuum

Tuf-Tite®, Inc. • 500 Capital Drive • Lake Zurich, IL 60047
800-382-7009 • 847-550-1011 • (fax) 847-550-8004 • www.tuf-tite.com
Plastic... Our Business, Not Our Hobby™



What Happened to Loyalty?

Use these strategies to encourage your best customers to come back again and again

By Lenann McGookey Gardner

Loyalty. It's a great concept — clients who appreciate you for what you do, and who wouldn't think of hiring anyone else to do pumping or portable sanitation work for them. It's kind of a quaint notion. But loyalty's mostly dead.

Let's check out that bold statement. Are you loyal? Think of the people who provide services for you; do you continue to patronize them without even thinking about it? Or do you "shop around?"

America — and much of the rest of the world — has evolved into a culture of shoppers. People are always looking for a better deal, a lower price or some miracle that will allow them to get acceptably good services for much less. They may not seek out other bidders, but when an amazing offer comes their way, it's hard to ignore.

In a world where the best clients are often seeking competitive quotes, what can be done to grow a firm's revenue base? Here are simple ways for you to increase customer loyalty and encourage repeat business:

1 Have a plan for sustaining relationships

If your clients aren't hearing from you, they're probably not thinking about you. But they are thinking about the people who called them today, offering a

better deal for the services you currently provide.

Do you have a system for getting in touch with your regular customers on a regular basis? You should. A minimum of one contact per quarter is essential, more if there are legitimate reasons for you to call. If nothing else, send an article likely to be of interest to them and put a personal note on it saying that you're thinking of them. Let them know you would be happy to discuss the subject of the article, their situation or overall progress with them sometime soon. Say you'll call them next week to set up a time for that chat, if they feel it's appropriate.

2 Share the story

When you have made a significant difference for a customer, create a case study — the story of a customer's experience with you — written in narrative form. Maybe your portable sanitation service helped a special event to be successful. Or your timely handling of an emergency septic system repair saved a homeowner from having to install a new system. Explain to customers that you go out of your way to provide the best service as a matter of course. You keep the case studies, like client testimonials, for the benefit of others who might consider hiring you for a project, so they can under-

stand the ways you've been able to help others generate revenue or save money. And when customers read a case study that involves their company, their special event or their onsite system, it will boost their egos and encourage them to maintain their loyalty to your business. If you don't have the time to put together case studies, there are companies specializing in that type of research and reporting.

3 Earn the business

Set aside time every week to communicate with at least a few of your customers. Set up a schedule to ensure contacts are made regularly — and always act on requests you uncover, even if they veer from the usual services you provide. Maybe you can refer customers to someone you know who can help them with specific needs when you are unable. Could you locate some information for them? Can you help in any way at all? If so, then do it. Going out of your way to help a customer might cost you a little in the short term, but in the

long term the extra effort you made will be noticed by the customer.

WORKING ON LOYALTY

It's naïve to expect clients — no matter how satisfied — to be loyal for the long haul to any supplier of services. No matter what you do, you can assume customers are forever alert to the possibility that they may be overspending. And beyond the issue of costs for services, there's an appeal to anything that's fresh and new.

But it's clearly easier for your loyal customers to respond to the solicitation of new competition — someone who says he can do the same job and do it for less — when the relationship with you has been allowed to deteriorate. Another truism is that it's easier to garner sales from an existing customer than it is to go out and find a new customer. But gaining that golden repeat business requires nurturing business relationships ... And remembering that loyalty is a two-way street. ■

Lenann McGookey Gardner is the author of *Got Sales? The Complete Guide to Today's Proven Methods for Selling Services*. She can be reached at 508/828-1788 or e-mail her at Lenann@YouCanSell.com.

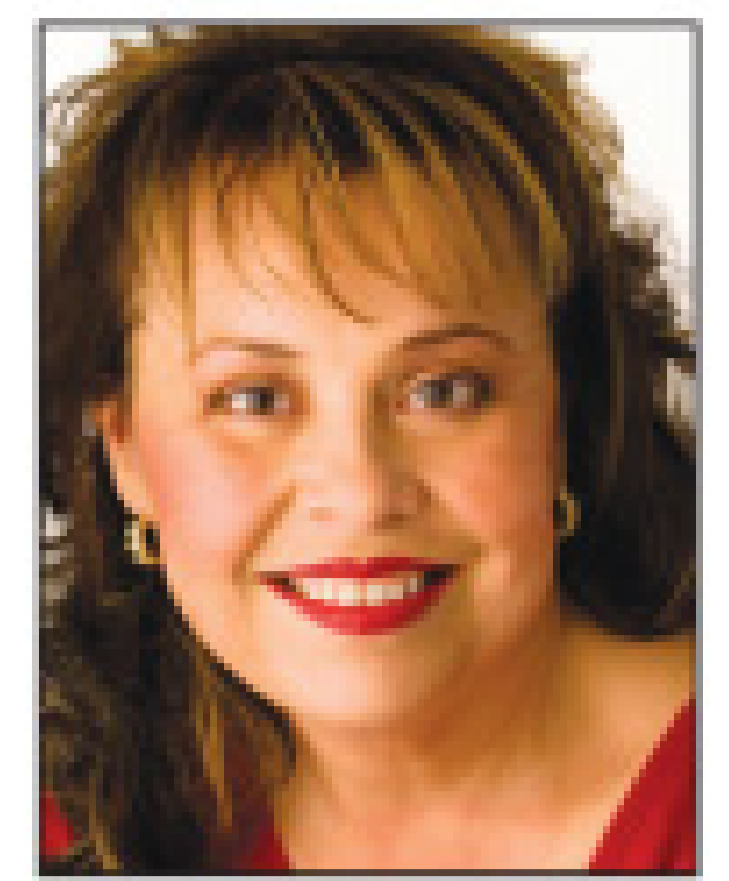

It's naïve to expect clients — no matter how satisfied — to be loyal for the long haul to any supplier of services. No matter what you do, you can assume customers are forever alert to the possibility that they may be overspending.

PRO
PORTABLE RESTROOM OPERATOR

100% Portable Sanitation

FREE to Qualified Industry Professionals!

Subscribe online at www.promonthly.com or Phone 800-257-7222

2008 V.E. Enterprises Eagle Vacuum Trailer



Why Choose A V.E. Enterprises Trailer?

Ten good reasons:

1. Built by ASME certified welders
2. All vertical welds are sub-arc welded providing 100% penetration
3. ASTM SA-36 grade 1/4" steel barrel, heads and baffles
4. Barrel padded with 1/4" plate at all contact points
5. 4" channel ring supports on barrel
6. 4-wide hose troughs with added bracing for pumps
7. Wedge shaped sump with 4" butterfly valves extended close to bumper
8. Trailers prepped with steel shot blast creating a 2.5 mil anchor profile
9. Dual EZ access side / rear entry to walkways (optional)
10. Built for and by our customers with over a dozen design improvements in 2007

* ASME & non-code bobtails / trailers available from 80 to 200 barrels

Setting the Standard For Liquid Storage and Transport Markets Since 1987.

800-234-2329

www.veenterprises.com
sales@veenterprises.com

10834 St. Highway 53 • P.O. Box 369 • Springer, OK 73458

VE
ENTERPRISES, INC.

"oh, it's that smell again"



FUME GUARD
Septic Seal

Now you can get rid of it for them with new FumeGuard® septic seal.

- Self-sealing adhesive
- Creates a fume barrier between the manhole/cleanout & cover
- Eliminates unwanted odors from septic tanks.
- Quick and easy to install (in less than 60 seconds)
- Adds profits per service call.
- Customers will love you — everyone wins.

So, call today and ask for FumeGuard. Find out how you can get rid of that smell for your customers **and make bigger profits for you.**



Booth 6069

800.332.7325
www.conseal.com

CONSEAL™
Concrete Sealants INC.

- ISO 9001:2000 Registered Company
- Water Based Coatings
- Polyolefin Backed Exterior Joint Wraps
- Controlled Expansion Waterstop Sealants
- NSF Listed & Fuel Resistant Butyl Sealants



Booth 4010, 4013



Heavy-Duty Towable Backhoe

FAST • AFFORDABLE • COMPACT • DURABLE

Gets you to the job site fast without secondary equipment!

- 18 hp engine
- Digging depth up to 8 feet
- Hydraulic drive for job site mobility
- Torsion block suspension for easy towing
- Quality machine – Built to last!



GO • FOR • DIGGER
www.gofordigger.com

1681 Halleck Rd. • Morgantown, WV 26505
800-876-0738 • Fax: 304-296-5034

Septic Tracker

Septic software for pumpers.
Designed for a pumper, by a pumper.

- ◆ The first year of support is **FREE!**
- ◆ Easy to use. No other software required.
- ◆ See all of a customer's information and history on one screen.
- ◆ Generates completed reports; including Pumping, Customer History, Income, a customizable report by criteria, and much more...
- ◆ Scheduling Calendar, Work Orders, Dispatching, Invoices, Reminders, Past Due Accounts, Disposal Tracking, Employees, Vehicle Service, Mailing Labels and more...
- ◆ You can use Septic Tracker with portable toilet rentals, drain clearing, and any other service. You name your services.
- ◆ Use the **FREE DEMO** for 30 days. If you decide to purchase the program, you can activate your demo permanently. No need to re-enter data!!



Booth 66

1-888-308-0651

www.septictracker.com
loren@septictracker.com

SOLD

1999 International 9100 M-11 Cummins, 280 HP, 9-speed, 350,000 miles. **NEW 2500-gallon** carbon steel tank. **NEW 240 CFM** vacuum pump, gearbox driven by PTO
Price:**\$36,500**

READY FOR IMMEDIATE DELIVERY
CALL US TOLL-FREE: **877-296-2555**



2001 International 4900, DT466, 210 HP, 33,000 GVW, 7-speed, 236,000 miles **NEW 2300 gallon** carbon steel tank with 3-inch inlet, 4-inch outlet, rear and top manways **NEW MEC 8000** Battioni pump (242 CFM), gearbox driven, air PTO
Price**\$ 43,900**



Price
\$150,000
+ F.E.T.



NVE 506 4-inch pump 500CFM and jetter, 10 gpm, 2400 psi

4200-gallon 2-chamber (4000 septic, 200 fresh) **PROGRESS** aluminum tank with a full rear-opening door and a hoist.

Booth 6223, Truck spaces 5223 & 5225
See our exhibit at the Kentucky Exposition Center in Louisville

Used Unit



2005 Ford 550 power stroke diesel, automatic, 92,000 miles, PS/AC, Used **850-gallon aluminum 2-chamber tank**, Anthony Lift Gate (holds total of 4 toilets), **MEC2000** vacuum pump, **8 HP Honda** 5 gpm demand pump.
Price: **\$41,500**

SPRING MOUNTS decrease fatigue on your tank frame, universally mounts to most tanks, Easy bolt or weld on style, Compact, Heavy-duty stress relieved springs.

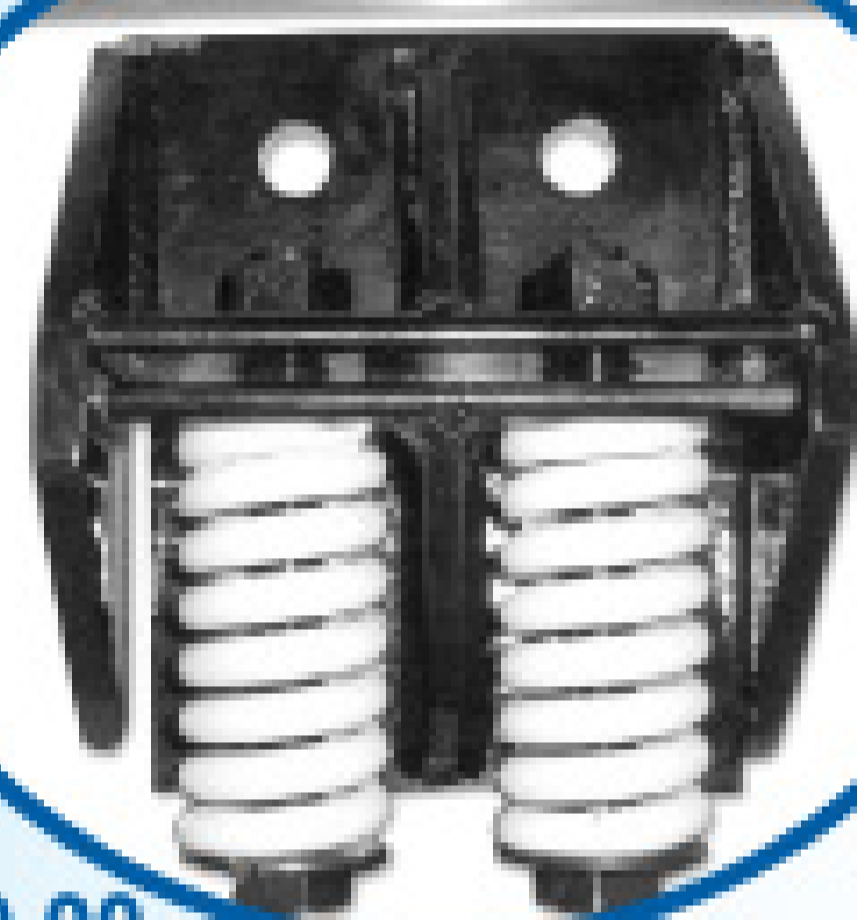

Mounts with springs..\$80.00
Springs alone\$10.00 each

WE

Wee Engineer
WITH IMAGINATION

Wee Vac

No more 3" sewer hoses running through restaurants. The Wee Vac fits through a standard doorway and can pump up to 45 gallons at a time. Wee Vac will even go up and down stairs when empty. It has a 3" female camlock so it can be downloaded into your truck. It features a 1 1/2" hose with wand & a 105 cfm, 110 volt vacuum pump.

Price: \$1060.00

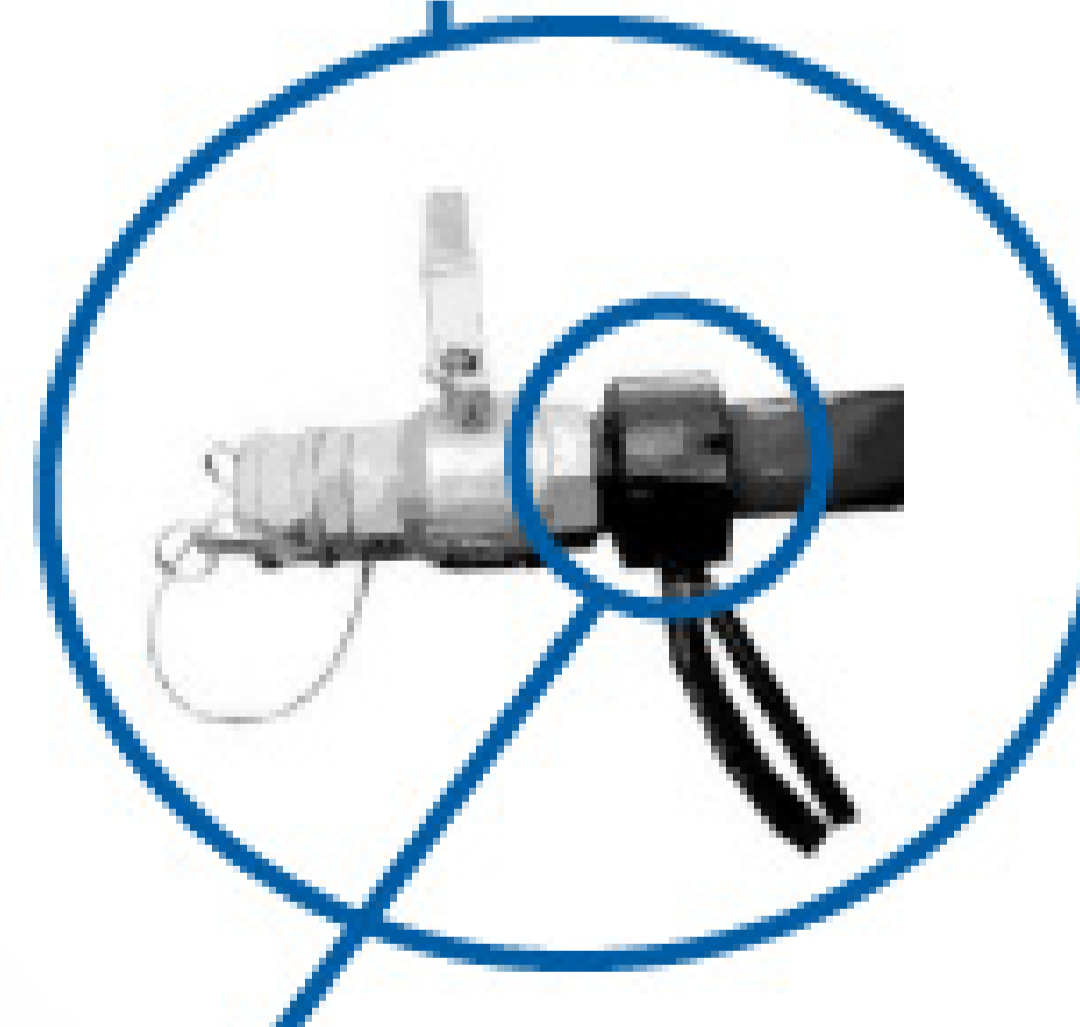

Add **Heated Collars** to your vacuum tank to help prevent the valves freezing. Many of our customers in the northern latitudes find that making a profit during the winter months is much easier with the installation of heated collars on their vacuum tank. The collars are both designed and built by Wee Engineer.

1 1/2 or 2 inch .. \$105.00	6 inch\$283.00
3 inch \$157.00	Installation Kit (no hose) ...\$76.50
4 inch \$189.00	110 V Heater Kit\$160.00

In Stock



IN STOCK

28-foot black Portable Toilet Trailer holds 14 units. Includes two 3500 GVW Torflex axles. 80-inch rear folddown center T-bar to accommodate a handicap unit.
Price**\$8138.00**



P.O. Box 39 Dayton, IN 47941 Toll-Free: 877-296-2555 Phone: 765-296-2027 Fax: 765-296-3027
www.wee-engineer.com

Michigan Vacuum Trucks

Custom Built Tanks to Your Specs!

P.O. Box 234 Carleton, MI 48117



Custom Built Vacuum Trucks to Meet Your Business Needs

**All trucks are equipped with Masport Pumps
1/4" Steel Construction**

Commercial Financing Options Available

Contact Anita McClintock
Cypress Financial Corp.
1-800-433-6189 ext110

THANK YOU

U.S. Ecology Idaho for purchasing a 4000 gallon vacuum unit from Michigan Vacuum Trucks.

Masport[®]
NVE

Specializing in
New Vacuum Trucks,
Used Vacuum Trucks,
Toilet Trailers & Slide in Units.

Purchase a New Portable Toilet Truck for only \$45,000*

Purchase a New 2,500 Gal. Vacuum Unit mounted on a New Kenworth T-300 Chassis Ready to Pump for only \$69,000

We Can Also Mount a Custom Designed Vacuum Tank on Your Chassis!

Call for a FREE quote today!

734.777.0390

*Prices are subject to change.

SmithCo
SIDE-DUMP TRAILERS

SIDE DUMP

Call 800-779-8099
www.sidedump.com

30902 C38
Le Mars, Iowa 51031



#5219 & 6219



CP-20 Offroad



SHV Series



DT Series



MHV Series



S Series

Manure, Slurry, Sludge, Green Waste, Food Residuals, Compost, SmithCo Hauls it All.

Stock Pile, Spread, Stability, Selection, Service...SmithCo

Irrigation fittings are for irrigating – NOT vacuum.
 How many dollars are you spending **SUCKING AIR?**
 Industry-proven, quality vacuum couplings from Bandlock
 will put money into your pockets.

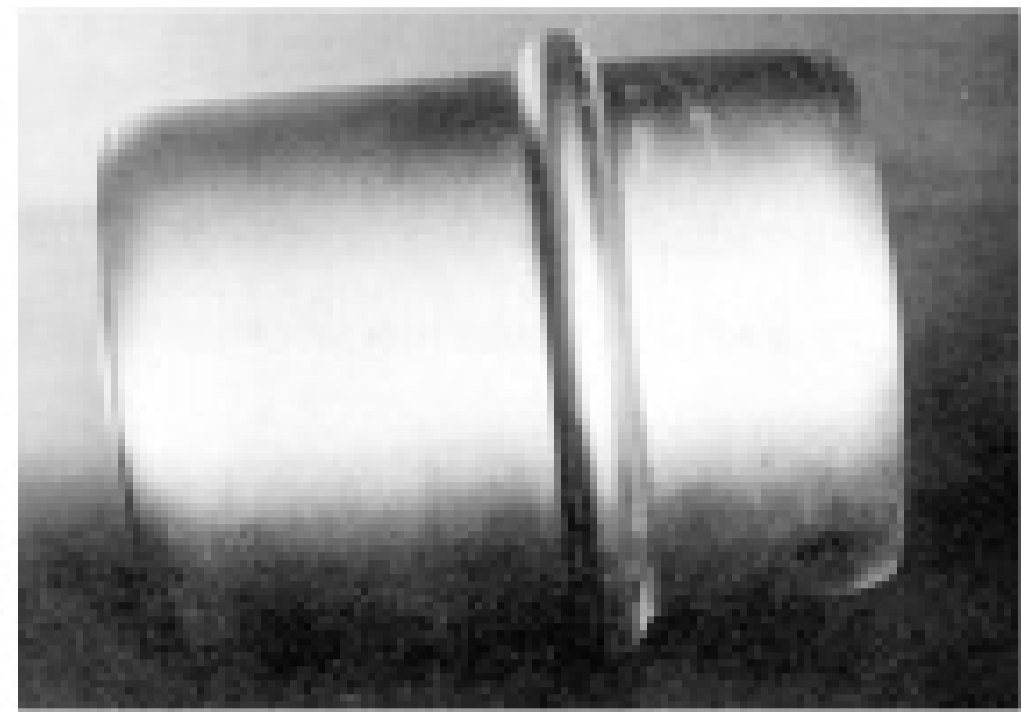

BANDLOCK BL
 4" to 12" MR Male Coupler



BANDLOCK BL
 4" to 12" FR Female Coupler



Aluminum Coupler RLM
 6" and 8" Aluminum
 Male Weldon



Steel
 Crown
 4", 6"
 and 8"
 Press
 End

**CLOSE TOLERANCE
 COUPLERS AND
 FITTINGS BRING
 "SAFETY" TO YOUR
 WORK PLACE.**



Booth 4080

**Recognized
 as the
 #1
 Relief Valve
 in the
 World**



Aluminum Pipe with Steel Press Ends,
 Steel Pipe Weldons, Aluminum Weldons

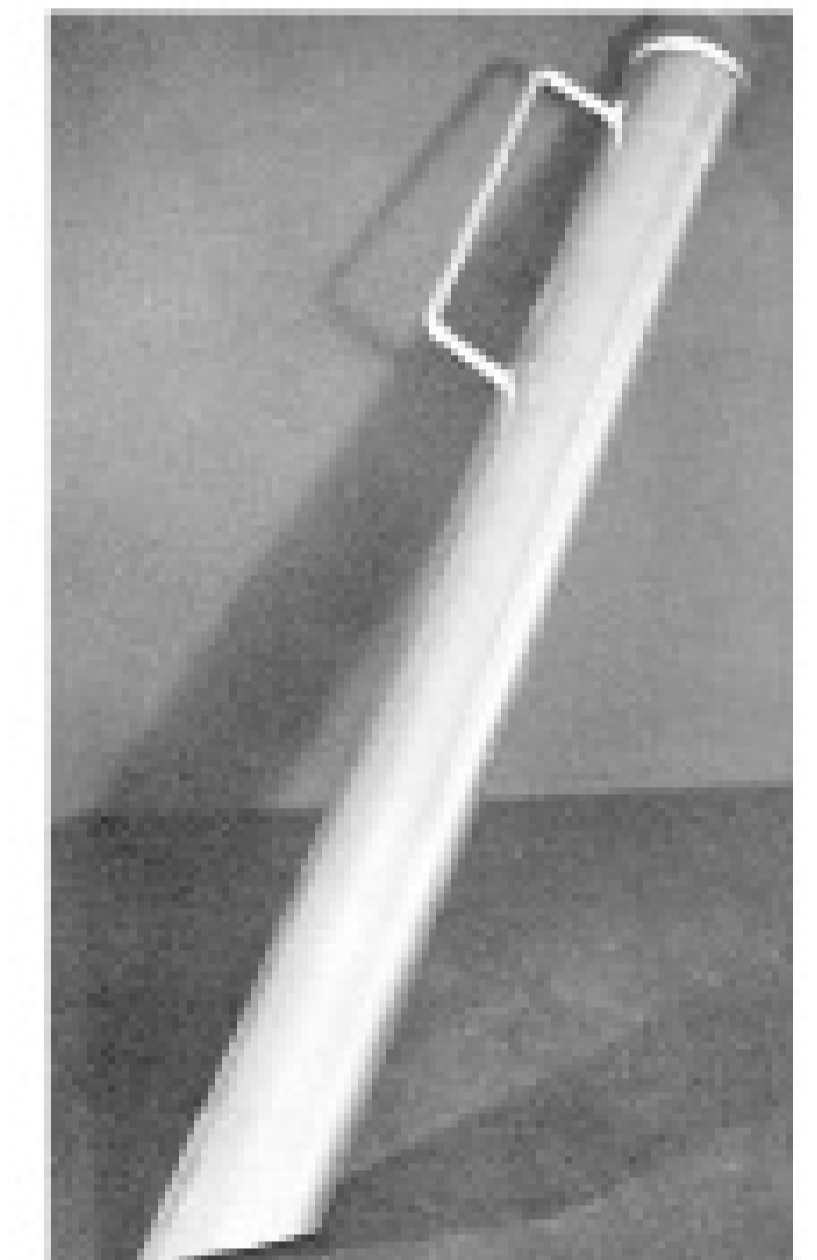

4" and 6" High
 Abrasive Bulk Nozzles
 Steel Reinforced

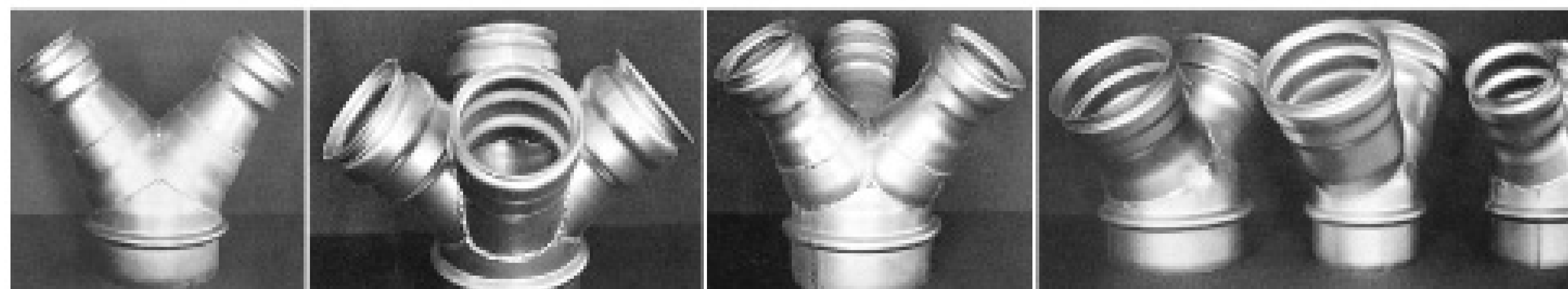

Special "Y" Reducer
 Any Size

Special "Y" Plus Reducer
 Any Size

Special "Y" Plus Reducer
 Any Size

BANDLOCK "Y"s: BL "Y"
 4" to 12"



BANDLOCK Reducers
 BL-300
 All Size Combinations



BANDLOCK Safety Discharge
 Female Coupler, Male Coupler
 BL-SFR 4" to 12", BL-SMR 4" to 12"



BANDLOCK Clamp
 Standard and International
 BLB 4" to 12"



BANDLOCK
 EZ Lift Clamps
 BLB-EZ 4" to 12"

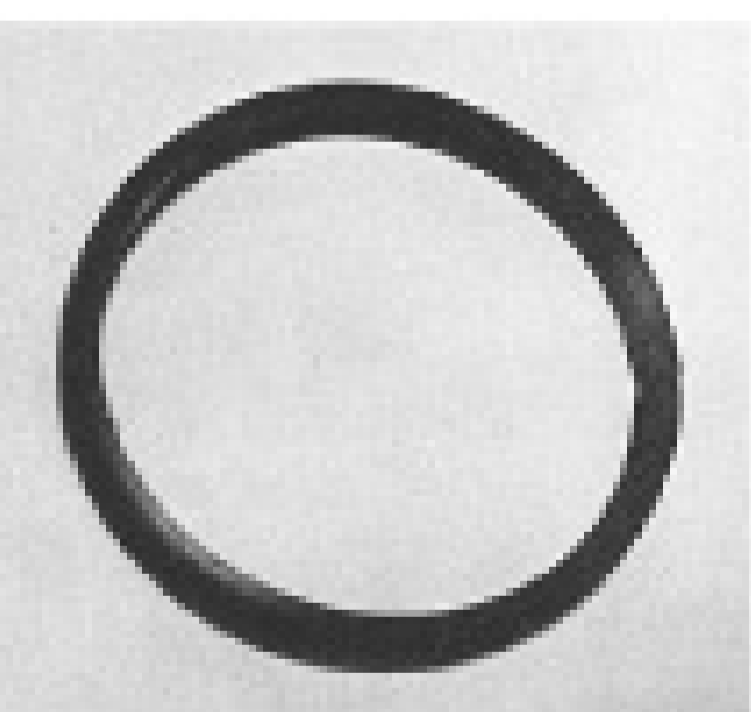

Profile Gaskets (Safety)
 4" to 12" Seals
 for Hazardous Materials



GO - 4" to 12"
 Rubber Gaskets



Male and Female
 BL-500M or BL-500F End Plug
 4", 5", 6", 8", 10" & 12"

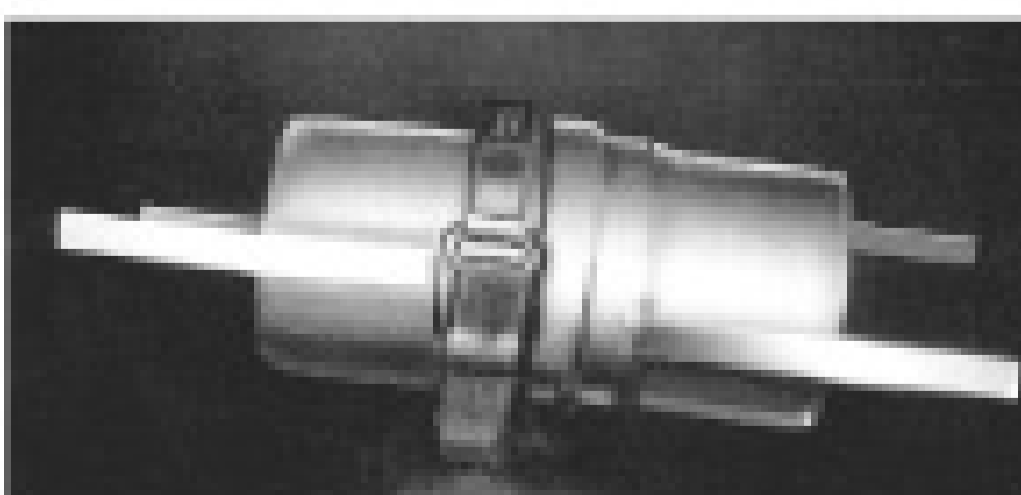

BANDLOCK Safety Discharge
 Coupler - Male Clamp, 2 Gaskets,
 Clamp with Safety Straps

**BANDLOCK
 Corp.**
MADE IN THE U.S.A.

SUPERIOR "QUICK" CONNECT VACUUM AND PRESSURE COUPLINGS AND ACCESSORIES

Call or fax today to get your catalog!

1-800-659-2978

Fax: 909-930-2551

www.amesbury.com

jcario@amesbury.com

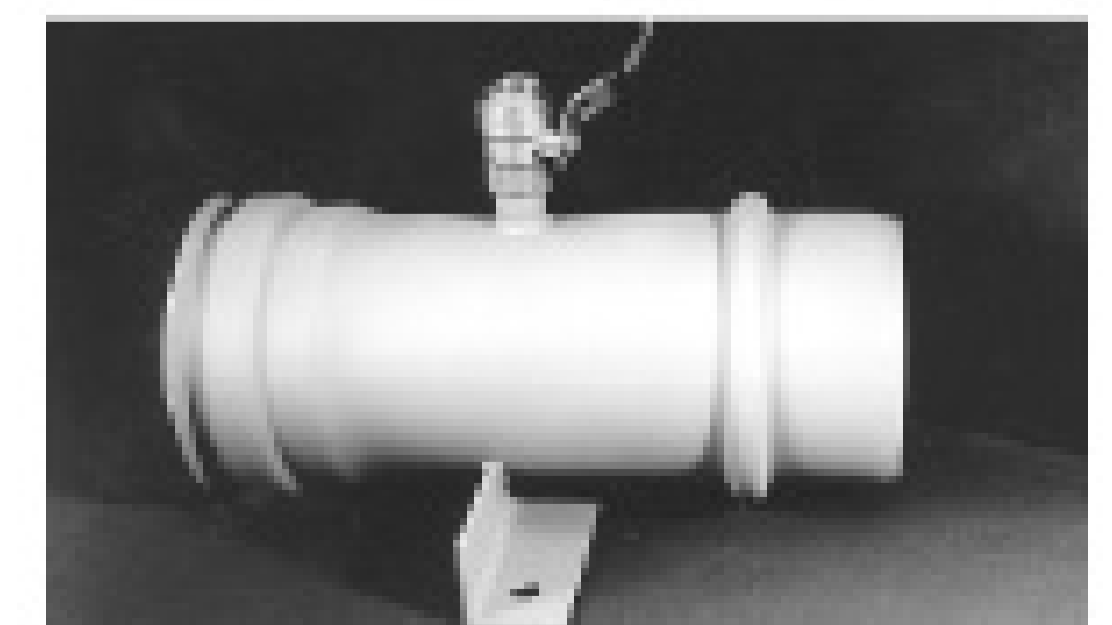

Wet Valve, 6", 360° Injected

Hull's Truck Bodies

459 Joe Shoemaker Rd. | Minford, OH 45653

Vacuum Trucks built to order, any size or make, delivery to all 50 states. Quick turn around time.



Phone: 877.898.5104

E-mail: hullstruckbodies@yahoo.com

Webpage: hullstruckbodies.com



4000 Gallon pumper on a 2007 M2 Freightliner

Tank: Bright finish aluminum-5/16" #5454 shell and heads 76" Dia.

Pumping system: Jurop LC420 water cooled pump
Chassis: Freightliner M2-54,000 GVW, C-7 Caterpillar 300 H.P., 10 speed transmission-14,600 front axle-40,000 air ride rear axle.

2800 Gallon pumper on a 2007 International

Tank: Bright finish aluminum-5/16" #5454 shell and heads

Pumping system: Massport HXL 15 (350 CFM)

Chassis: International 4300-33,000 GVW, 245 HP DT466-RDS 3500-12,000 front axle, 21,000 rear axle.

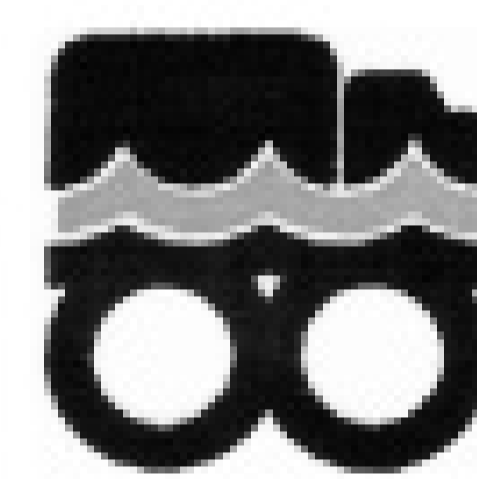

WHITE RIVER DISTRIBUTORS, INC.
BATESVILLE, ARKANSAS

(800)-548-7219
(870)-793-2374
www.lpgbobtails.com

POWER



1-800-758-4788

Vacuum Pumps & Tank Parts at WHOLESALE PRICES!

Jurop PRODUCTS INC.



PN84
• 252 cfm @ 18"
• Air Cooled

PN 23, 33, 55, 84, 106
IN STOCK.



LC20
• 425 cfm @ 18"
• Liquid Cooled



R260
• 304 cfm @ 18"
• Balast Port Cooling

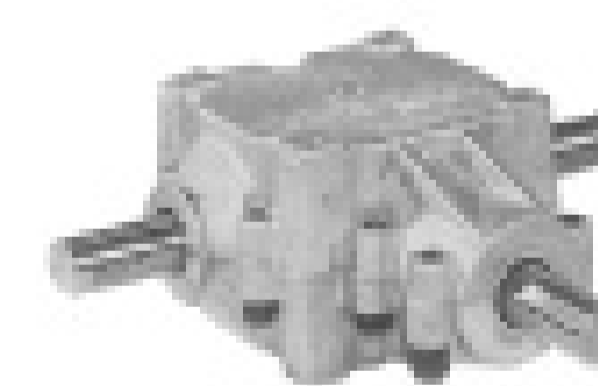

RT Angle Gearbox
1" - \$199
1 1/4" - \$299

Lever Action Gate Valve

Brass
2" - \$10
3" - \$98
4" - \$157
6" - \$288



Piston Action Gate Valve

Brass
4" - \$69
6" - \$183



Secondary

Nylon/Brass
2" - \$160
3" - \$206



Manway Special Gasket in lid
20"
35"

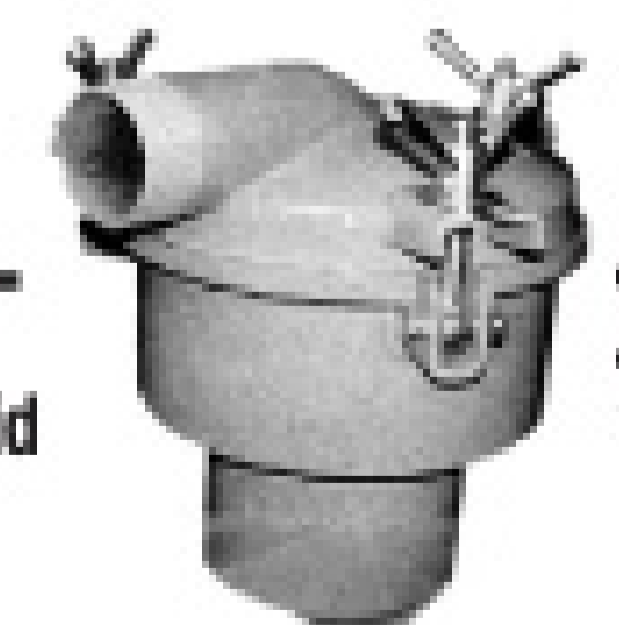

Low Pro Primary
\$295

POWERFLO MODEL:	PF330	PF540
Air capacity displacement	258 cfm	390 cfm
Air capacity displacement @ 15" Hg	248 cfm	370 cfm
Minimum vacuum	95%	95%
Minimum pressure	30 psi	38 psi
RPM	1200	1200
Weight	308 lbs	357 lbs

Performer Series PF540

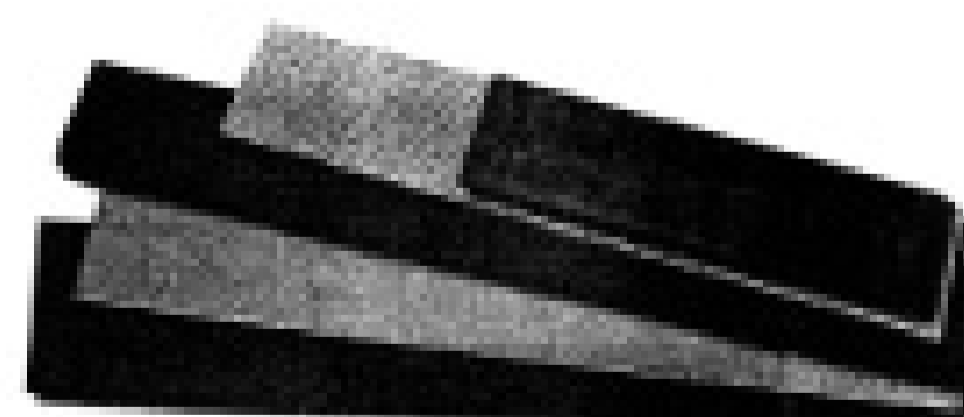

Dura-Comp Pump Vanes

Exclusive manufacturer since 1991. 400 non-asbestos material. Long lasting, self lubricating, satisfaction guaranteed!



DC-10

Heavy-Duty Washdown Pump

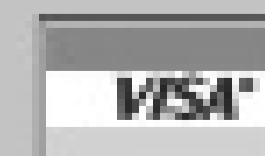

POWERFLO PRODUCTS INC. • 2755 N. Gaviota Ave. • Signal Hill, CA 90806 • Phone: 562-997-0720 • Fax: 562-997-0724

Over 60 Years of
Odor Control Technology

THE COLOR OF
RAW POWER

SURCO®

BlueMuscle™

Our STRONGEST Portable Toilet Deodorant EVER!

Call Us Today, and Stock-Up on the Strongest
Portable Toilet Deodorants in the Industry!

1-800-556-0111

Featured Product



NEW! Potty Fresh® PUMP!
Wall Spray with Metazene® Odor Neutralizer

A blast of instant, long-lasting
odor protection for portable toilets.

Problem odors causing customer complaints?
New Potty Fresh® PUMP attacks stubborn odors at
the molecular level with Metazene® odor neutralizer.
Simply spray on PT walls and around urinal (not on
floors, causes slippery conditions) for instant,
long-lasting extra odor protection.
Choose powerful Cherry or French Bouquet fragrance.

Visit us at booth 164!



Now Serving
Canada
from Our Toronto
Warehouse



SURCO®
PORTABLE SANITATION DIVISION

©2007 SPI

1-800-556-0111

292 Alpha Drive • Pittsburgh • 15238
412-252-7000 • fax 412-252-1005 • www.surcopt.com



Revolution: rev-o-lu-tion / a sudden, complete or marked change in something

Experience the revolution in Louisville:



Booth 1040

Preview the Restroom Trailer revolution:

www.restroomtechnology.com



ADVANCED CONTAINMENT SYSTEMS INC.
800.927.2271



Aqua-Zyme Disposal Systems

*"From the Grease Trap to the Garden"
- Dewatering & Composting -*

#1 Box on the market!

The ADS Dewatering System

is built by a pumping company for pumpers. You are welcome to come and watch the 30 yard box dewater 20,000 gallons of grease trap waste and/or septic tank waste in only 2 hours!

By using the ADS dewatering system along with our Compost Facility, we have turned our disposal costs into a profitable venture!

Call 979-245-5656 for Info!
\$ Financing Available \$

P.O. Box 489, Van Vleck, TX 77482 • www.aqua-zyme.com
1-979-245-5656 • zymme@aqua-zyme.com • U.S. Patent # 6,364,122



The Hunt for the Perfect Truck is Over

**Come
finish the
hunt at the
Pumper
Show
Booth #:
4155**



Still in the blind for the perfect truck? Let Jack Doheny Supplies be your hunting ground. With our herd of remanufactured, work ready and rental equipment in stock and on the ground your hunt is over. So impress your customers and bag your trophy truck at Jack Doheny Supplies.



Vactor Sewer Cleaners



Industrial Vacuum Loaders



Hydro Excavators



Cusco DOT Units



Sewer Equip. Co. Jettors



Pipeline Television
Inspection Equipment

Jack Doheny Supplies



*"World's Largest Distributor of Sewer Cleaning,
Air Handling and Street Sweeping Equipment"*

**Call Jack Doheny Supplies
to schedule your hunt**

800-336-4369

www.dohenysupplies.com

Pressure Transformer - The Intelligent Jetter

No need to change heads to vary your jetter output. The Pressure Transformer senses the demand that you need and automatically delivers it! Tank sizes ranging from 1,000 - 4,200 gallons and available in carbon steel, stainless steel or aluminum. Call today for more information.

0-90 GPM @ 0-2,850 PSI



Visit our Website at www.keithhuber.com
or give us a call at Ph#1-800-334-8237

Booth 14039

Oil Skimmer Sucking up money for vacuum trucks

Many times when oil is spilled, vacuum trucks are called for clean up. A vacuum truck using our skimmer will always get the job over a conventional rig because a vacuum truck using our skimmer is:

- 97% efficient
- Environmentally efficient
- Cost efficient
- Equipment efficient
- Simple and easy to use
- Recovers all types of oil
- Ideal for pits, lagoons and industrial oil recovery operations

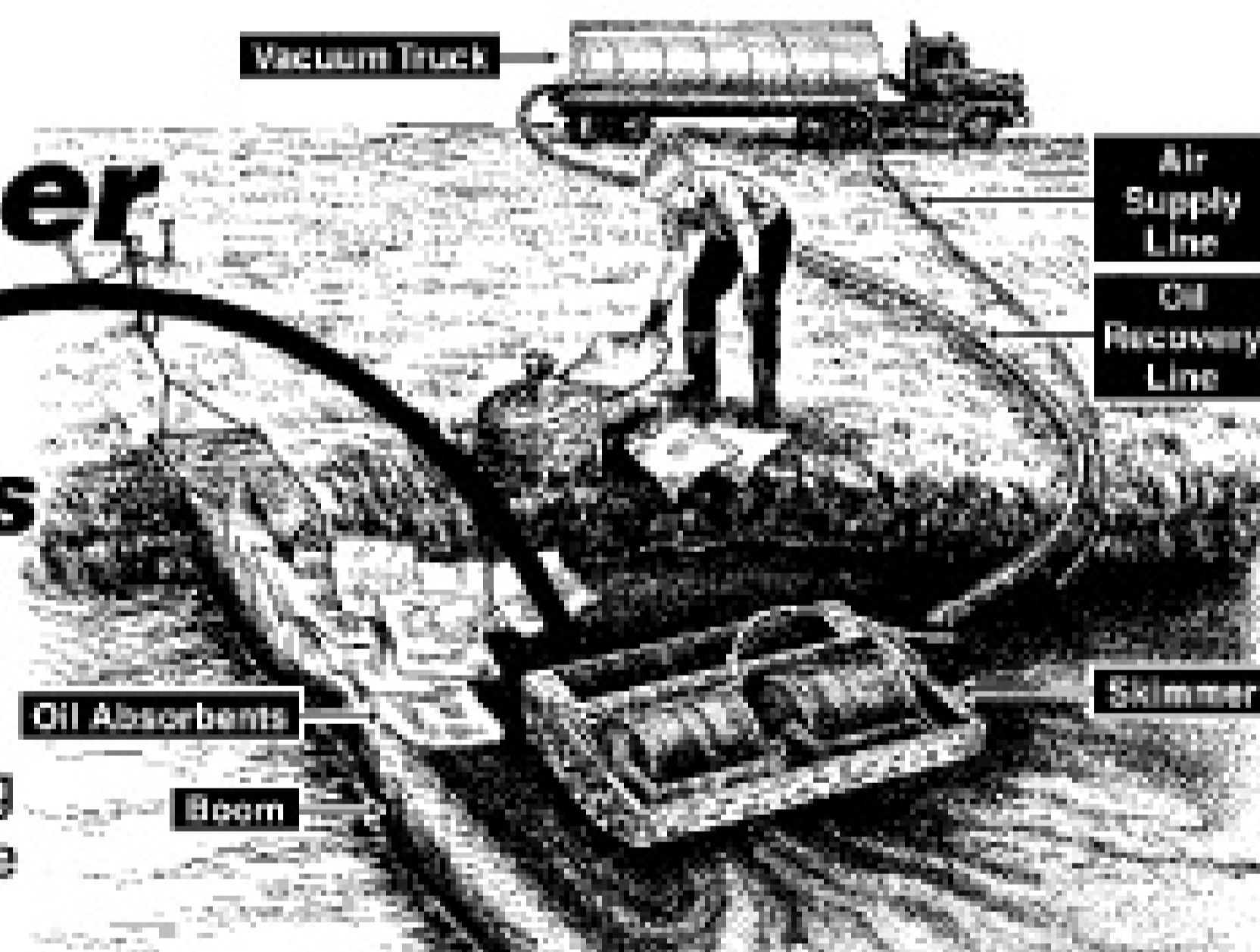

DrumIt The drum filling vacuum head with auto shut off



DrumIt quickly connects to vacuum truck. Ideal for chemical, oil or hazardous materials. Works on liquids, solids and sludges.

Trailer Mounted Vacuum Systems are Our Specialty



PACS is designed for easy dumping with fully opening rear door.

- Wide flotation tires and surge brakes for highway or off-road
- Various models available
- Standard units normally in stock
- Built with heavy-duty components
- Low maintenance with simple controls
- Designed for ease of towing
- Automatic mechanical shutoff
- Efficient and easy to use
- Extra strong frame withstands the difficult conditions of remote locations

Call for more info.
(618) 382-2525

www.elastec.com

ELASTEC
AmericanMarine
FOR INNOVATIVE ENVIRONMENTAL PRODUCTS

121 Council St., Carmi IL 62821 • Tel:618-382-2525 • Fax:618-382-3610 • Email:elastec@elastec.com

ROBUSCHI RB-DV Hi Vacuum Truck Blowers



Airflow range from 400 to 6,200 CFM
Vacuum up to 28" Hg

- Robuschi Patented Air Injection Manifolds allow blower to operate at 28" Hg continuously without the need for a Vacuum Relief Valve
- Light Weight Patented Air Injection Manifolds and Low Pulsation Technology ensure lower noise attenuation and less vibration than competitors by 10 dBA.
- The fabricated and cast Air Injection Manifolds and Feet Assemblies can be custom made to suit PTO angle and lower blower between chassis rails as well providing handy lifting hooks for safe and easy assembly and removal.
- Rubber Mounting Feet included with the Custom Made Feet Assemblies ensure any Chassis Flex doesn't affect blower durability

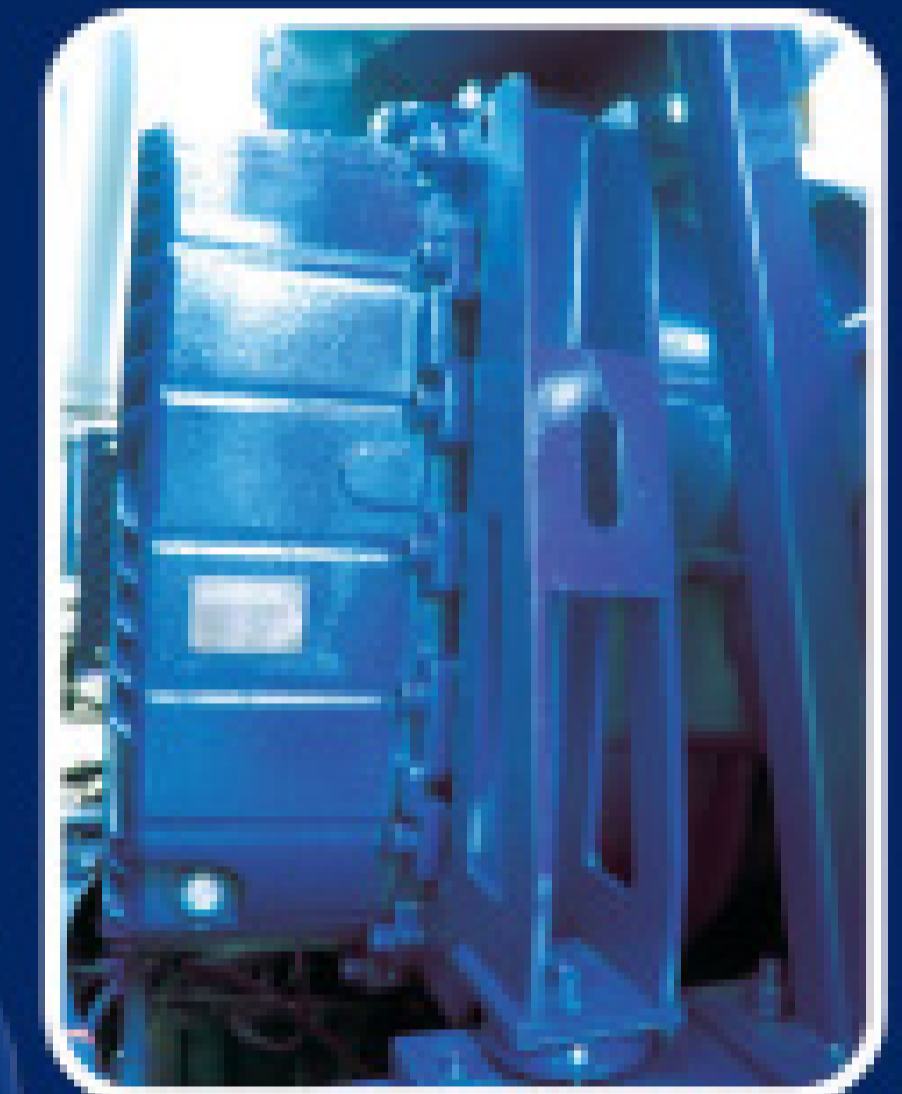

ROBUSCHI®

U S A I n c.

Charlotte, NC 28217

Toll free: 877-424-1020

E-mail: sales@robuschiusa.com

www.robuschiusa.com



Booth 8015



NAWT Sponsors Pumper & Cleaner Expo Education Day Seminar Track

We are excited to have the opportunity to present an entire seminar track during Education Day, Feb. 27, at the Pumper & Cleaner Environmental Expo in Louisville, Ky. The six seminars focus on topics related to our industry and will help pumpers expand their businesses, understand current federal regulations and gain valuable tools for advancing the land application of biosolids. Here is a summary of the presentations:

Responsible Management Entities

Robert Rubin, Ph.D., McKim & Creed Consulting, Cary, N.C.

When the U.S. Environmental Protection Agency announced its voluntary management guidelines, Models 4 and 5 stated that utilities would manage onsite systems. Our industry, unhappy with the EPA encouraging utilities to "take over," convinced the agency to adopt the use of Responsible Management Entities instead of utilities.

Most pumpers don't think of themselves as RMEs, even though they already are through offering service contracts and troubleshooting systems. They remain intimidated by the lofty-sounding term. This presentation will give haulers and other service providers the vision of how they fit into the role of RME and how to prepare for it.

Expert's Review of Aerobic Treatment Unit Operation and Maintenance

Bruce Lesikar, Ph.D., P.E., Texas A & M University

Today, many onsite systems use aerobic treatment units as pretreatment devices instead of septic tanks. Advanced units require a higher level of maintenance, but most pumpers don't understand that they are not serviced like septic tanks. Many pump out ATUs incorrectly, and often a pump-out isn't required to fix the problem.

Aerobic treatment units are just one piece of advanced pretreatment technology, and they all require operation and maintenance activities to assure oxygen delivery to the wastewater. Lesikar's Tricks of the Trade seminar discusses performance assessment by identifying components and evaluating their operational status. He will provide checklist guides to ensure that ATUs are serviced properly and teach pumpers how to recognize opportunities for additional repeat work.

SEPTAGE CANNOT BE CLASSIFIED AS RESIDENTIAL, COMMERCIAL OR INDUSTRIAL. SEPTAGE IS ONLY THE MATERIAL PUMPED FROM SEPTIC TANKS.

REGISTRATION FORM

NAWT Inspection Training & Certification, Louisville, KY • Feb. 25-26, 2008

NAWT Vacuum Truck Technician Training, Louisville, KY • Feb. 26, 2008



Name _____ Company _____

Address _____ City _____ State _____ ZIP _____

E-mail _____ Phone _____ Fax _____

Inspection Training & Certification • Feb. 25-26, 2008

- Full Registration Fee:** \$395 Member; \$495 Non-Member
 Recertification Fee (Day 1 or 2 Only): \$295 Member; \$395 Non-Member

Vacuum Truck Technician Training • Feb. 26, 2008

- Full Registration Fee:** \$175

PAYMENT METHOD: Check enclosed (Payable to NAWT) VISA MasterCard

Card Number: _____ Expiration Date: _____ Name on Card: _____

Signature _____

Fax or send your form with payment to the NAWT office by Feb. 15, 2008.
Pre-registration and pre-payment required.

NAWT

336 Chestnut Lane, Ambler, PA 19002-1001

Registrations with payment information may be faxed to 267/200-0279. Questions? Call NAWT at 800/236-6298.

A Visionary Review of the Agricultural Utilization of Septage

Stephen Rohm, Blessings Composting, Delaware

Recent changes in federal and state regulations require haulers to become nutrient managers if they wish to continue land-applying septage. That may sound complicated and intimidating, but this presentation will prove otherwise. Items to be discussed are:

- Impacts of recent Clean Water Act changes on septage land application.
- Total Maximum Daily Loads and the watershed approach to limit nutrient pollutant.
- U.S. Department of Agriculture/Natural Resources Conservation Service nutrient management requirements and record-keeping for nutrient appliers.
- USDA/NRCS weather and seasonal land-application restrictions for organic waste fertilizers.
- Sources of information and guidance to comply with changes that affect the land application of septage. Software is available to help pumpers keep the required records, and if it comes from the EPA, it may be free.

Why a Municipality Opens a Septage Treatment Facility

Chris Buday, director of public works, Grand Traverse County, Mich.

Grand Traverse County has a large number of onsite systems, and land application was the only disposal option available. However, this option is not available year-round due to rain, snow, frozen ground and crop issues. The county, which has no treatment plants, felt it was its civic duty to build a facility that accepts septage.

Many municipal treatment plants are apprehensive about taking septage, while others handle it very successfully. The technology is here. This case history includes bullet points pumpers can use in conversations with municipalities about handling septage.

When is Septage Really Septage?

Tom Frank, Tim Frank Septic Tank Cleaning Co., Huntsburg, Ohio

Septage cannot be classified as residential, commercial or industrial. Septage is only the material pumped from septic tanks. As professionals, you must know how to properly handle and dispose of non-septage wastes, such as those from car washes, catch basins, holding tanks and process waters or oil spills entering onsite systems.

Just because material can be vacuumed into a truck doesn't mean it can be hauled legally. Pumpers will learn when to check if a permit is necessary and how to handle non-residential wastes, dispose of them through proper outlets and document the process. Call NAWT to learn whom to call to check if you're legal.

How to Survive an EPA Audit

John Coletti, EPA Region 5 biosolids coordinator

Those who want to land-apply septage must meet certain federal requirements. A possible EPA audit should not be intimidating to pumpers who use software to record how many gallons were applied where and have kept those records for five years. Pumpers with incomplete or no paper trails can be fined \$27,000 a day.

This seminar discusses the requirements set forth in 40 CFR Part 503 for land-applied septage, including application rates, vector attraction and pathogen reduction alternatives, pH adjustment and temperature correction and record-keeping.

Check NAWT's Web site at www.nawt.org for the latest updates on our training programs and seminars.

Tom Ferrero is executive director of the National Association of Wastewater Transporters Inc.

Offering a Complete Line of Portable Toilet & Septic Needs

Introducing our two newest
All-Natural Products!

Nano Eliminator Deodorant and Graffiti Remover

**Non-Toxic
Environmentally Friendly**



Del Vel Chem
C O M P A N Y



Serviceing the Industry with Pride Since 1994

250 Old Marlton Pike • Medford, New Jersey 08055
609-714-2424 • Fax: 609-714-3030 • 800-699-9903

Dewatering Equipment



14014 & 14015

Use The Right Equipment To Get The Best Results.

Liquid Reduction = Reduced Transportation Costs
Dewatering = Reduced Tipping Fees
Non Organic Separation = Facilitate Land Application of Liquids

ACCENT
MANUFACTURING INC.

Designed for Simplicity. Engineered for Durability.

Toll Free: 877.855.4890

info@accentmanufacturing.com • www.accentmanufacturing.com

Dyna-Vac Equipment

VACUUM PUMPING &
SEWER CLEANING EQUIPMENT

Jet-N-Vac

Experience the Compact Power, Enduring Reliability and Piece of Mind Economy of the Jet-N-Vac Systems. Necessary Features make these units Simple, Safe and Reliable while delivering the power for the toughest cleaning jobs

NEW

Mechanical Drive System..Eliminates Costly, Inefficient Hydraulic Drives

Patent Pending

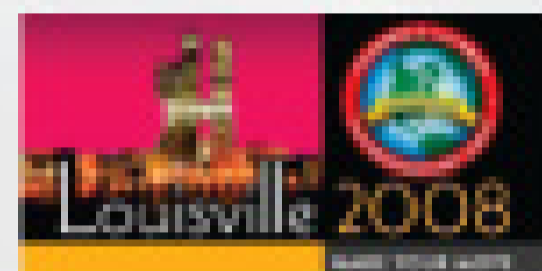

See the Jet-N-Vac in Louisville
Booth 7168

888-298-8668 * 315-865-8084 * www.dynavacequipment.com

View Our Entire Line at:
www.grnleafinc.com

MANUFACTURER OF
liquid handling
PRODUCTS



VISIT BOOTH
4028

GREEN LEAF
INCORPORATED

An ISO 9001/Q 9001 Certified Company

P. O. BOX 88 • FONTANET, IN 47851 USA • P/ 800-654-9808 • F/ 812-877-4278 • W/ www.grnleafinc.com • E/ sales@grnleafinc.com



OMSI Transmissions, Inc.

Dependable
Advanced
Revolutionary
Tough



OMSI will help you hit the bull's-eye
on your transmission project.

Visit us at
Booth # 13037

OMSI Transmissions, Inc.
9319-A Ravenna Road Twinsburg, Ohio 44087 USA
Telephone 330 - 405 - 7350 | Fax 330 - 405 - 7351
www.omsitransmissions.com omsi@omsitransmissions.com

Safety First... We've got a handle on it!



Booth 22

Introducing Safety Bump™... The Solution to Transport Hose Problems



Safety Bumps™ replace traditional cam and groove caps and plugs, providing a comfortable handle for the driver's hand and a "bump" that extends beyond the hose fittings and ears, protecting them from damage. Safety Bumps, patent pending, are available in three inch and four inch, male and female models, in both hazardous and food grade configurations. Made from a glass-filled composite with antistatic additive or a food grade certified composite.



New Safety Lock™ eliminates spills due to cam lock ears opening up during deliveries. Safety Locks™, patent pending, replace unreliable Velcro straps and hard-to-operate locking cam lock ears with an easy-to-install and easy-to-remove, heavy duty 'clip' which clicks into place over the ears.

Save Your Drivers' Hands. Protect Your Fittings and Hose Trays. Safety Bumps™ now Available in 2 inch



Safety Pumping Systems
(858) 530-8705
www.safetybumps.com
info@safetypump.com



Western Pacific Products, Inc.
"ANYTHING IN OR ON YOUR TANK"

THE service program

Simple Software for Your Service Solutions

The Leading QuickBooks® add-on Software for today's Portable Sanitation Business.

- Interface with QuickBooks®-The Service Program generates your recurring route billing and seamlessly allows you to print the invoices in QuickBooks®.
- Easily Manage Routes
- Track Pick-Ups & Drop-Offs
- Palm and Windows PDA Handheld Support w/Remote Sync
- Works with Mapquest®
- Track Inventory at Multiple Locations
- 30-Day Money Back Guarantee-Leasing Available



Booth 21016

866.480.1879

www.theserviceprogram.com

Happy Valentine's Day!



Vacuum Pumps & Equipment, Inc.

Toll Free: 800-533-5858

www.hmvacuumumps.com



ONLY THE FINEST PRODUCT LINES!



CHALLENGER • CHANDLER • CONDE • JUROP • MORO • NVE • ROBUSCHI • THOMPSON TANK • UTILE

PROVIDING SERVICE WORLDWIDE - CALL TODAY!



Booth 7141

Factory Built-Work-Ready IN STOCK Selection of *progress tank* Vacuum Service Truck Tanks



NEW! 2008 International MaxForce 25,999 GVW

4300 Series MaxForce, 215HP M7 V8 diesel, 560 ft.lb. torque Allison 2100 RDS auto trans, air brakes, 10,000 lb front, tilt wheel, AM/FM vertical pipe AC, heated mirrors.

2000 Gallon **PORTA VAC** Restroom Service

500 fresh / 1500 waste Masport HXL 4 w/ pre-filter, Burks wash down, Hot shift PTO w/remote, 4" Discharge, Unit hauler and tow package.

\$76,200 Lease from **\$1524.** mo.



Unit #1239

2000 Gallon Restroom Tank HXL 4 pump, Burks DC10 washdown 2008 Ford 750 6 spd., hyd.brakes

\$74,400

Monthly lease from **\$1,488**



Unit # 1273

1500 Gallon Restroom Tank HXL 4, dual service, 2 reels 2008 Isuzu NRR Auto., hyd. brakes

\$70,500

Monthly lease from **\$1,410**



1250 Gallon Restroom Service

Masport HXL4, Burks DC10, P.T.O. 2008 Sterling Bullet - 20,500 GVW Cummins 305 HP / Auto. transmission

\$66,400

Monthly lease from **\$1,328**

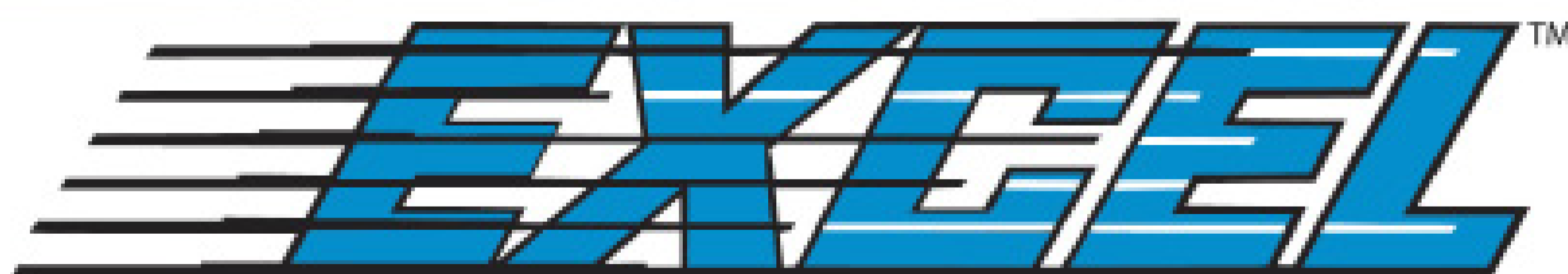

EQUIPMENT & SUPPLY CO INC.

1-800-392-3513

www.excel-equipment.com

Tel: 317-882-1300 Fax: 317-889-0052
585 Sayre Court, Greenwood, IN 46143

Unit #1124

800 Gallon Combo Unit 10' Bed with Liftgate Dual Service 2007 Ford 550 XLT Upgraded interior, power windows, locks and mirrors.

\$72,230

Monthly lease from **\$1,446**



Unit # 1303

4200 Septic Tank Masport HXL400 water cooled. 2007 Sterling 9500 58,000 G.V.W., 410/450 HP, 10 speed

\$129,000

Plus FET
Monthly lease from **\$2,580**





SUPERVAC
2000 inc.
Vacuum pump trucks

Head office & factory: Québec, Canada
1043, Renault street, St-Jean-Chrysostome (Qc) G6Z 1B6
Phone: 418-839-5702 Toll free: 866-839-5702 Fax: 418-839-1816
Email: ddoufour@supervac2000.com • www.supervac2000.com

Ontario sales office:
25, St-Joseph St, St-Catharines (On), L2S 1N8
Cell: 905-570-5702 Fax: 905-688-5164
Email: dcorcoran@supervac2000.com • www.supervac2000.com

HYDRO-EXCAVATOR

- Carbon steel debris tank 3 000 gallons (us)
- Copolymer water tank 12000 gallons (us), insulated aluminium enclosure
- Transfer case
- Heavy-duty water pump 6000 psi, 10 gpm
- Insulated enclosure (less than 85 DBA)
- Hose reel capacity of 100' each • Boiler capacity of 880 000 btu each
- Vacuum pump 6400 cfm, 27" Hg • Two (2) cyclones, cartridge filter
- Auxiliary vacuum /pressure pump 400 cfm, 4 way valve, secondary moisture trap, oil catch
- Hydraulic boom, 26 ft radius, hydraulic door locks



HIGH VACUUM (SVPT-6400) D.O.T. 407/412

- 3000 gallons (us), D.O.T. tank 407/412
- 6400 cfm, 27" Hg., high vacuum pump
- Auxiliary Vacuum/pressure pump 350 cfm
- 100 gallons (us) water tank
- Water pump 3000 psi, 6 gpm
- Wet and dry mode
- Hydraulic boom, 3200, 15' long
- Hydraulic door locks
- Transfer case
- Aluminium tight tool boxes



COME SEE US
BOOTH #7031



TO DO THE BEST JOB, YOU NEED THE RIGHT EQUIPMENT

Liquid-Cooled Vacuum Pump 5 Models Ranging from 530-1883 cfm

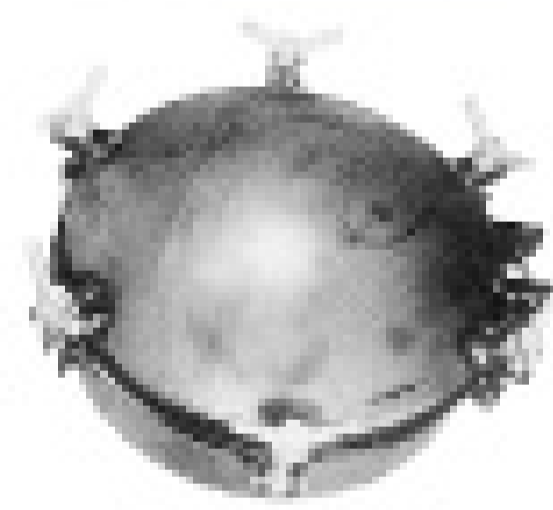
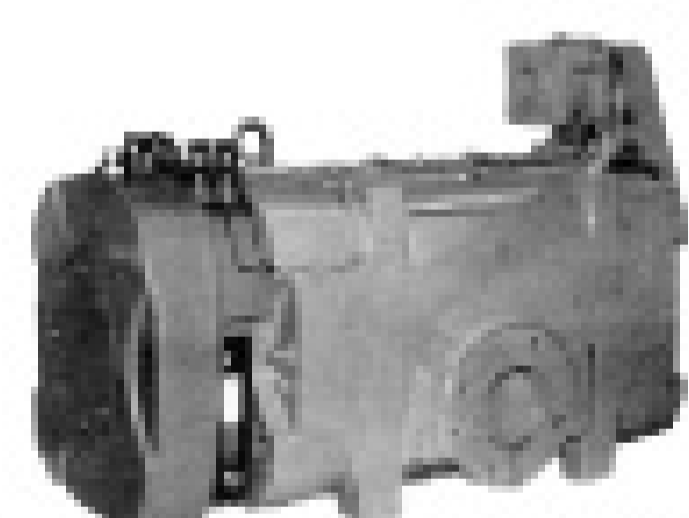

Manways
12", 17", 21", 25", 36"

When You Really Have to Get to the Bottom...



Sight Glasses

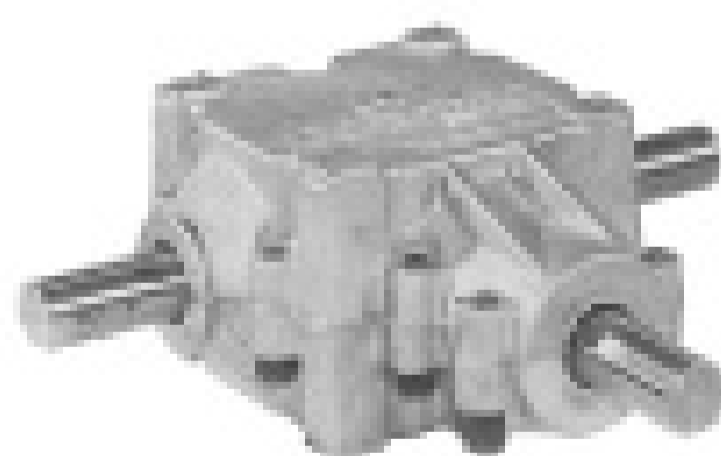

Angle Gearbox

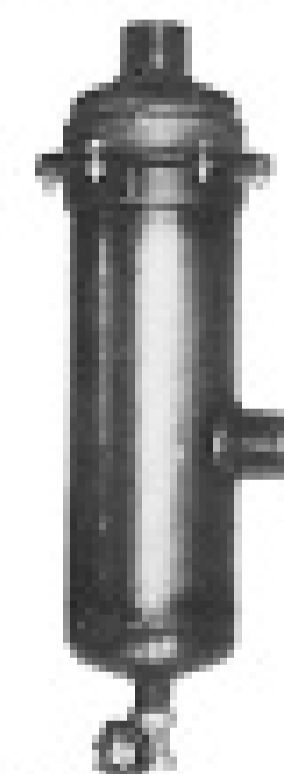

Secondary Checks



Brass Ball Valves
2" x35
3" x115
4" x165

Want That Extra Edge From Your Vacuum Truck?

utile vacuum pumps



LW 625 [393cfm]

LW 825 [535cfm]

- 27" Continuous Vacuum
- 35 psig Discharge Pressure
- 800-1100 Operating Speed
- Completely Self-Contained
- Fan and Ballast Port Cooling

Designed with Quality, Built for Performance, A Generation Ahead

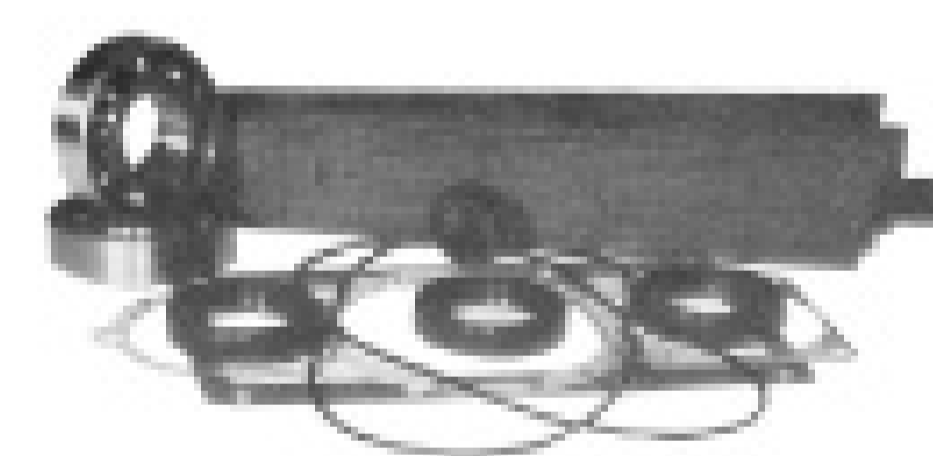

Pump Service and Repair Kits
(Most Major Mfg's.)



Portal Shutoff

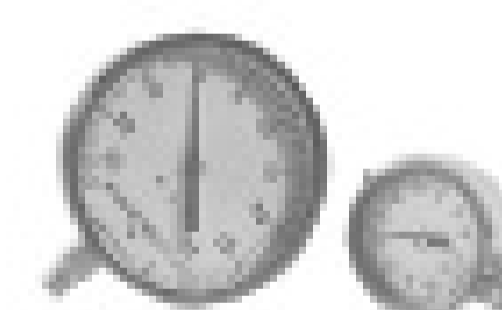

Vacuum Gauges

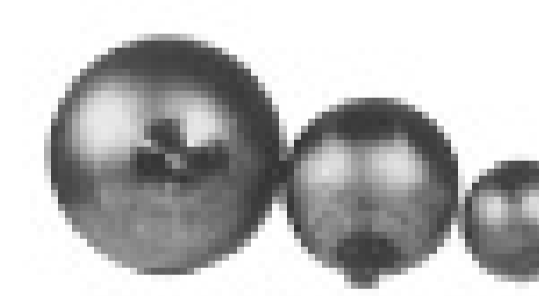

Stainless Steel Float Balls

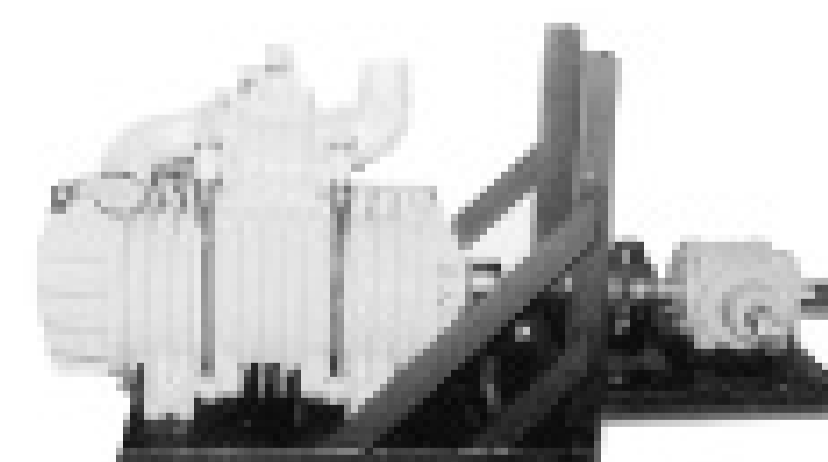
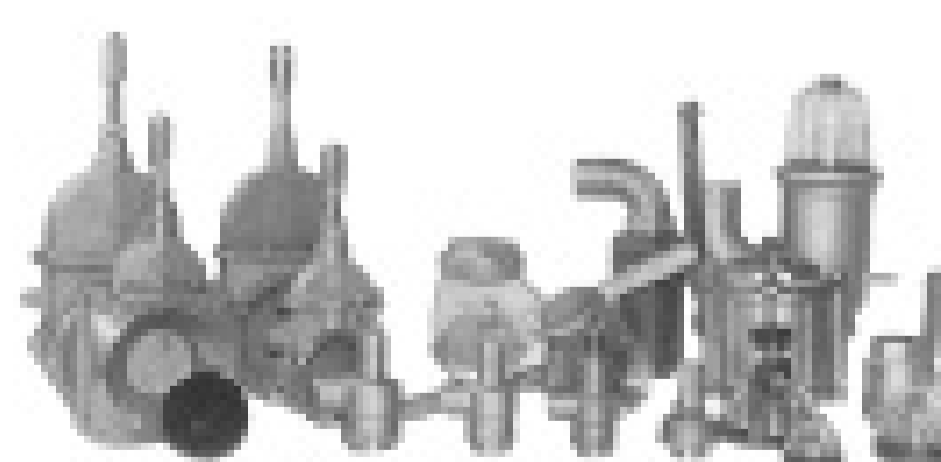

Pump and Gearbox Frames



Betts Valves

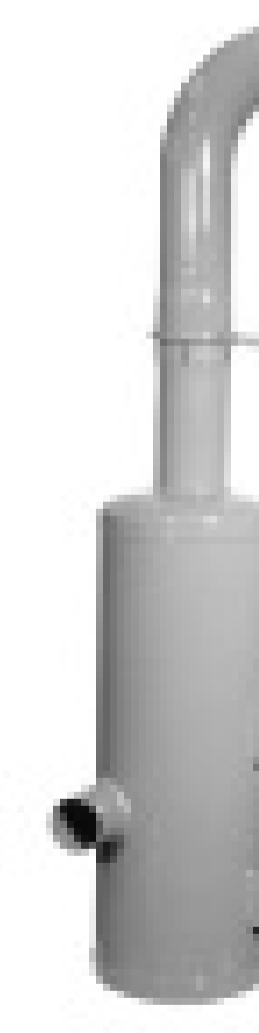

Oil Catch Mufflers

NVE

Corporate Office
1-800-243-7986

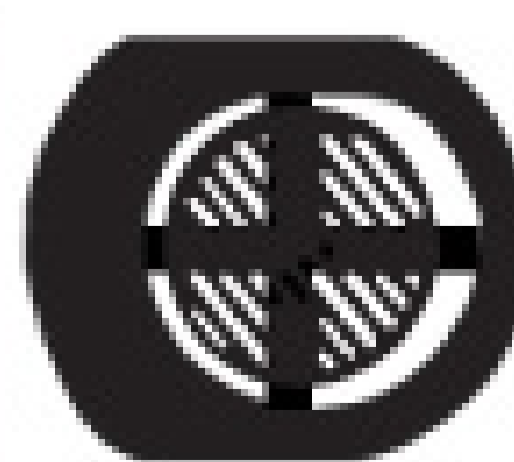

COM VAC
SYSTEMS

Southern Sales
1-800-346-7789

Masport

BEST ENTERPRISES, INC.

300/110 Slide In



400/200 Slide In



3,600 gallon Stainless Steel Tank on an 2008 International Truck. (54,000 gvw)3,000 waste and 600 fresh water.



Custom Build

Visit us at the
Pumper Show!
Booth: 7208
Truck Spots:
7207 & 7211

WOW



3,200 gallon - All Waste
Stainless Steel ROLL OFF TANK



**See It At
The Show**

2,500 gallon - All Waste
Stainless Steel Septic Truck



For the **BEST** price
the **BEST** product
the **BEST** service after the sale
Make the **BEST** decision
on your new equipment.
See you at booths 7208 & 7210



Best Enterprises, Inc.
3513 W. Mt. Springs Rd. Cabot, AR 72023
1-800-288-2378
www.bestenterprises.net

Product News

PRODUCT SPOTLIGHT

FMI Service Trailer

By Ken Wysocky

Startup or small-scale portable sanitation businesses that can't afford a nicely outfitted service truck have another option from FMI Trucks Sales & Service: the WorkMate portable restroom service trailer, which offers the basic amenities of a service truck.

"The trailer is designed with the small restroom operator in mind, or someone who's just getting started in the business," explains John Barrett, a sales consultant for FMI's vacuum truck division. "With this trailer, you don't need to buy a separate service truck, or pay the associated higher operating, insurance and licensing costs. Instead, you can pull the trailer with a pick-up truck."

Designed with tandem axles that are over-rated for 5,200 pounds per axle, the all-steel trailer is 19 feet long and 8 1/2-feet wide, with a gross vehicle weight rating of 7,800 pounds. It comes with a standard 2 5/16-inch ball hitch, and a built-in tongue jack.

The trailer can carry two standard restrooms. It's also equipped with a carbon-steel, 325-gallon wastewater tank and two 75-gallon, polyethylene freshwater tanks. Plumbed in tandem, the tanks can be used either together or individually (one for pre-mix deodorant water and the other for freshwater). A 12-volt water pump made by Jabsco, a division of ITT Corp., delivers freshwater at 10 gpm.

A Masport HXL1-V pump with a two-way valve, rated at 36 cfm, powers the self-contained vacuum system. A Honda 5 1/2-hp, electric-start engine drives the pump, and a 12-volt battery supplies basic power to the trailer. The battery sits inside a polyethylene storage box mounted on the draw-



bar. A tow vehicle charge cord allows operators to continually recharge the battery, Barrett notes.

The trailer comes ready to use with a 30-foot vacuum hose, wand and buckets. The hose and coupling are situated low to the ground for easy access. The trailer also features a curbside, dry-product storage box that measures 60 x 24 x 18 inches. For more information, visit www.fmitrucks.com or call 800/927-8750; Expo booth 2209.



JAG Mobile Introduces Porta-Lisa Plus

The **Porta-Lisa Plus** mobile restroom trailer from JAG Mobile Solutions measures 12 x 7 feet and features three private restrooms, air conditioning, flushing toilets, 156 gallons of onboard running water and a 470-gallon capacity waste tank. Options include the Super Chute that allows trash to be directed to the service area and consolidated in a central location for removal, and a solar power unit that can run all day without having to recharge. A range of interiors are available. For more information: 800/815-2557; www.porta-lisa.com; Expo booth 7131.



Reelcraft Designs Self-Contained Hose Trailer

The self-contained hose reel trailer from Reelcraft eliminates the need for a dedicated maintenance vehicle. Designed for grounds maintenance applications requiring up to 1-inch I.D. by 100 feet of hose, the trailer bed also offers additional space for tool trays and other accessories. The wheelbase matches typical work vehicles, with wheels mounted

inside the trailer bed to prevent snagging on trees and shrubs. The 32-inch trailer tongue allows for sharp turns and easier backup. For more information: 800/444-3134; www.reelcraft.com; Expo booth 6051.



Self-Contained Hose Reel Trailer from Reelcraft



Safety Lock from Safety Pumping Systems

Safety Pumping Systems Introduces Safety Locks

The Safety Lock from Safety Pumping Systems eliminates the chance for cam lock ears to open during deliveries due to pulsing or vibration. Designed to complement its Safety

Bump, the lock system features a heavy duty clip that fits over the cam ears, replacing Velcro straps and locking cams. The locks are offered in 3-inch female fittings with 4-inch and 2-inch fittings available. For more information: 858/530-8286; www.safetypump.com; Expo booth 22.

Carlton Offers Universal Drum Lock

The universal drum lock from Carlton Industries LP works on both metal and plastic drums and is completely reusable. Featuring a non-sparking, metal construction, each set of locks contains devices for both openings of one standard 55-gallon drum and instructions. For more information: 800/231-5988; www.carltonusa.com. ■

Everyone's talking about it.

Find out why.
Get your **FREE** subscription today.

ONSITE
installer

PROMOTING WASTEWATER TREATMENT
QUALITY AND PROFESSIONAL EXCELLENCE

Visit www.onsiteinstaller.com or call 800-257-7222.



Tanks For Your Business

Mid-State Tank manufactures stainless steel and aluminum tanks and has become a well-known and respected supplier for the agricultural, aviation, industrial and fire services, as well as pressure/vacuum tanks.

Mid-State Tank holds an ASME stamp and is D.O.T. approved.



Booth 4000-4001

Mid-State Tank Co., Inc.

PO Box 317 • Sullivan, IL 61951

(800) 722-8384 • Fax: (217) 728-8384

www.midstatetank.com



Tell 'Em

"I'm Pre-Approved" on Financing

New or Used...

< **Show Special:** Documentation fees
waived for pre-approved customers >

Community Leasing Associates, LLC

1-877-459-5770

www.clalease.com



Good People - Great Rates



Booth 9322



#5207, 6209



We Have Financing Available!



2007 Sterling AUTO TRANS 2500/300 Gallon Aluminum, PM80 pump Cat 275HP, Allison Auto, Exhaust brake, Traction Control.

\$92,000



2007 Sterling 2500 gallon Steel Jurop pump, Mercedes 260 HP, 10 spd, engine brake, Traction control ALUMINUM HOSE TRAYS.

\$77,500 Plus FET



2007 Sterling AUTO TRANS 4000 gallon steel tank, Jurop pump, Cat 330HP, Allison auto 18K ft, 40K rear exhaust brake, ALUMINUM TRAYS.

\$102,000 Plus FET

Now In **STOCK!**

On-The-Lot Selection *Call For Prices & Pre -Approval!*

Call Us Today Toll-Free:

888-201-9166

Septic - Portable Toilet - Hoisted Vacuum - Slide-Ins
New! Units Available / Trade-ins Accepted! / Financing & Lease Plans



Gasoline Hot Water Unit With Hose Reel

Aqua Blast has several models within the Gasoline Hot Water category, including Jetters. Our units range from 1600 to 10,000 psi at 3 to 10 gpm and have an adjustable hot water thermostat.

AQUA BLAST also offers the following styles of units with 900 psi to 30,000 psi and 2 gpm to 500 gpm.

Central cleaning systems with the installation of plug-in stations for hoses.

- Electric, gas, diesel or propane
- Truck, trailer or skid mounted, portable
- Hot, cold or steam



Booth 6221

AQUA BLAST *Manufacturer of High Pressure Cleaning Systems*

800-338-7373 • 260-728-4433 • Fax: 260-728-4517

E-mail: davidt@aquablast.com • www.aquablast.com

Seal it Tight! Seal it Easy! Seal it Fast!

Booth 6167

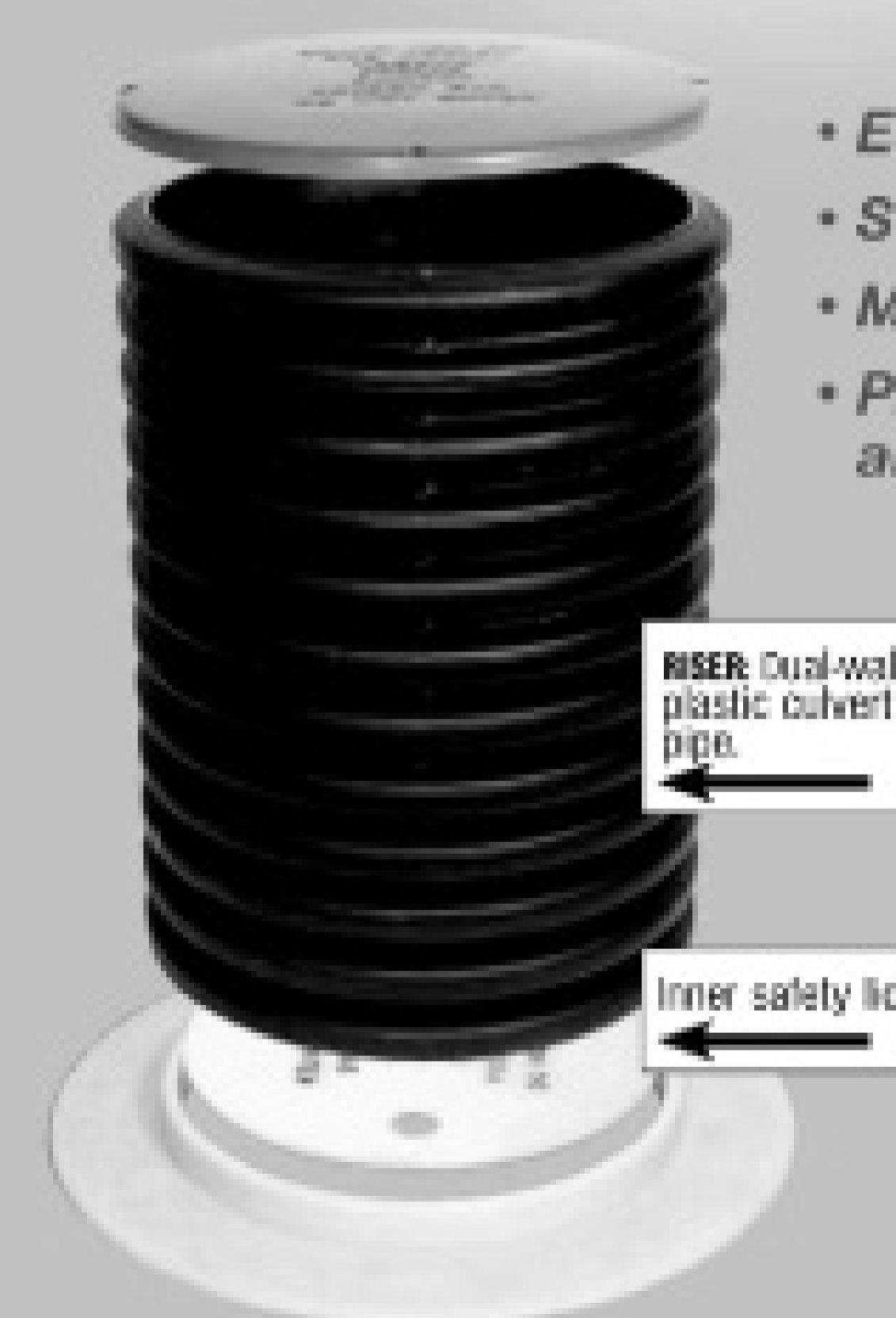

- Easy 10 minute installation!
- Secure fit for all systems!
- Made & sold by septic installers!
- Prevent ground water infiltration and save money at the same time!



Apply foam sealant to tank.



Place ring over opening and apply foam.



Place plastic maintenance pipe or ring.



Install lid.

Are you tired of using risers that are too tall or too short for the job you are completing? Plastic riser pipe will give an exact height each time. Try our system and you will never have to carry concrete pipe and lids again. Save time by not having to assemble multiple sections.

Seal-R® Lids Available in 12", 15", 18", 24", 30", 36".
Seal-R® Rings Available in 18", 24", 30".
Inner Safety Lids Available in 18", 24".

Seal-R® Lids can be personalized. Seal-R® Lids are constructed with UV additive to resist degradation from exposure to sunlight.

For more information, call us today!

BrenLin Company, Inc
Manufacturers of Seal-R® Products
Herman, MN
888-606-1998
Fax: 320-677-3001 • Email: brenlin@brenlin.com

www.seal-r.com

We've Got You Covered

Whatever you need in ground protection mats

With the acquisition of Mobile Mats, AlturnaMATS now is able to offer the broadest line of ground protection mats in the industry...literally, we've got you covered. Now Mobile Mats will be available through AlturnaMATS' and MobileMats' extensive dealer networks. All three mats leave soft turf smooth, even under heavy vehicle traffic and all are guaranteed for 6 years. No costly turf repair bills and NEVER GET STUCK AGAIN.



Landscaping



Tree Care

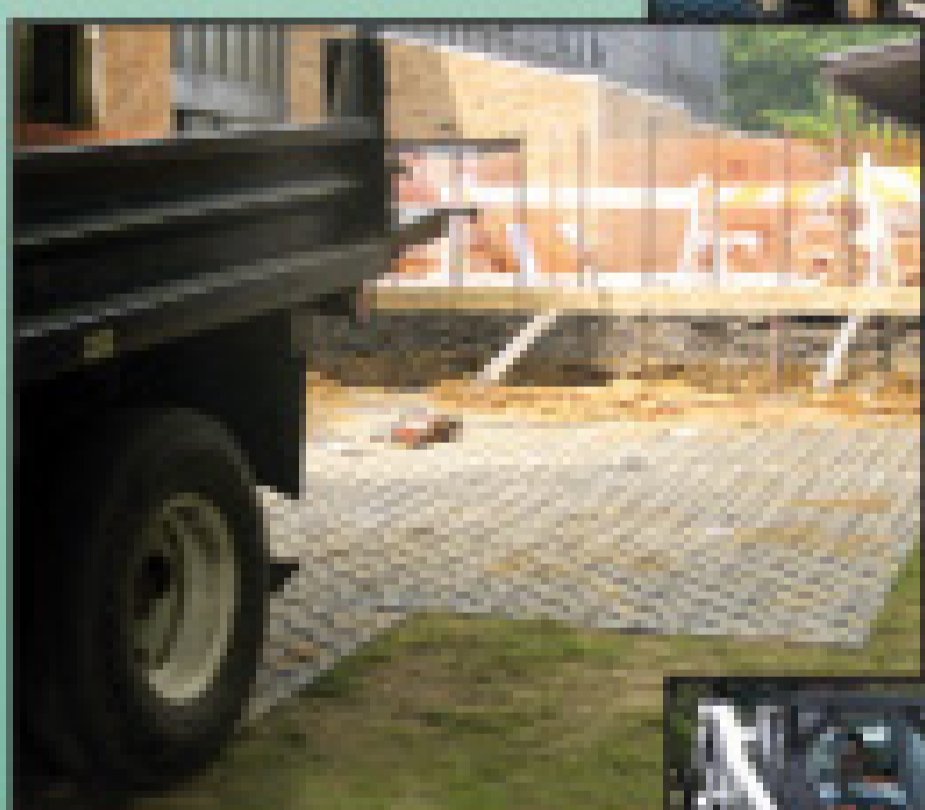

Construction



Cemetery



Drilling

One-Piece Plastic Outrigger Pads

Rugged, one piece pads with rope handle. Available in wide variety of sizes to suit the application.



AlturnaMATS

- 1/2" thick polyethylene
- Supports 60 ton vehicles
- Lasts for years
- Leaves turf smooth in soft conditions
- Withstands record heat & cold
- Never get stuck again

VersaMATS

- 1/2" thick polyethylene
- Features the bold diamond plate tread on one side and a finer, slip-resistant tread on the other side
- Ideal for 60 ton vehicles as well as pedestrian traffic
- Last for years... 6 guaranteed



- Slightly lighter in weight
- Features a waffle shaped tread design
- Four hand slots for easy handling
- Ultra-high molecular weight, high density polyethylene



AlturnaMATS continues as the world's largest producer of quality ground protection mats.

AlturnaMATS®

sales@alturnamats.com

www.alturnamats.com

Call for the name of your nearby dealer: 888-544-6287

Tanks built
for work and
built to last.



Amthor is Built Strong

Looking for a new tank? Think Amthor.

At Amthor, we deserve our reputation for quality, innovation and expertise. Our products meet the demands of today's consumer AND exceed industry expectations. With a nationwide distribution network, delivery is simplified. Plus, you'll enjoy exceptional customer service. Visit us online for specific product information.



Amthor Matador
Run-About



www.AmthorInternational.com

For your nearest distributor contact: Hank Vanderveen

VA Office: 434.656.6233 • Tel/Fax: 252.293.1284 • Cell: 845.494.0104

FINANCING

FOR ALL YOUR
NEW & USED EQUIPMENT

GIVE US A CALL TODAY!
866-769-2345



Booth 7070

31 YEARS OF EXPERIENCE
WORKING FOR YOU!

- Application Only to \$250,000.00
- Simple Approval Process
- Lease or Loan Options
- Aggressive on Used Equipment
- Start-up Programs
- Flexible Financing Available



CAPITAL PARTNERS

101 N. Main Ave. Suite 215
Sioux Falls, SD 57104
www.yourcapitalpartner.com
866-769-2345

YOUR ONE STOP
FINANCING PARTNER

Competitive Pricing, Simple Processing,
Honest Answers

Inventory of New & Used! We Build Pumper Trucks

- ✓ 1,500 Gooseneck Vacuum Trailers
- ✓ 1,500-3,400 Gallon Vacuum Trucks

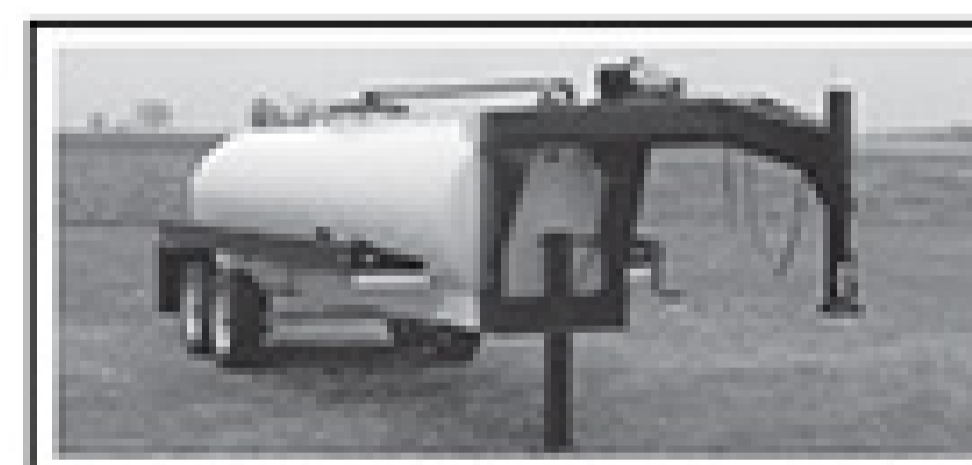

Moro Pump
Dealer



Redneck Trailer
Parts Dealer



16028-17029

B&W .. Because Nobody
Has Time for Down Time

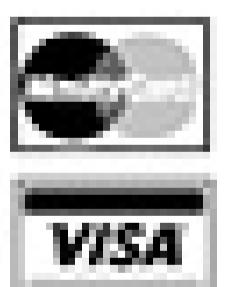

ALL TANKS ARE MADE IN THE USA
ALL TANKS ARE COMPLETED AND THEN PRESSURE TESTED

B&W MANTRAD INCORPORATED
4000 E. Jackson • Macomb, IL 61455
309-837-1989 • fax 309-837-1919 • bandwent@macomb.com

40 Years
Experience

CALL TODAY
FOR INFORMATION OR PRICES
ON TANKS, PUMPS AND ALL PARTS

Mobile Dewatering Systems by BDP

Advantages of the BDP Model 3DP Belt Press mobile dewatering system:

- Independent Gravity Zone at waist level when installed on the trailer, easily observable by the operator
- Elevated cake discharge. Discharge directly into the truck or dumpster, no dumping on the ground and additional conveyors or loader are needed.
- Ease of accessibility for maintenance



- Tubular frame (*right*) provides a flat surface with fewer corners and ledges. Clean up is easier, with less corrosion.
- Process performance exceeding any other manufacturer: highest liquid flow rate, highest cake solids, lowest polymer usage.
- Lowest maintenance cost and significantly lower down time for maintenance.



BDP Industries, Inc. will provide a complete custom dewatering system package, wired and plumbed with foldout walkways, area heaters, and controls.

Visit us at Booths 7006-7009 at the 2008 Pumper & Cleaner Expo

Industry References:

Synagro Inc.
MSD Environmental
Blue Heron

Parker Agg
LWI, Inc.



BDP Industries, Inc. 354 Route 29 Greenwich, NY 12834 Tel: 518-527-5417, Fax: 518.695.5417 Email: Kelly@bdpindustries.com
www.bdpindustries.com

ProCAM™ DVD

Color Mini Camera Inspection System with DVD Player/Recorder

- 10.4" Color LCD Monitor
- 110 VAC or 12 VDC Operation
- Power Control Unit Weighs Only 17 Pounds
- Optional Rechargeable Battery Pack Kit Available
- Optional Pro Eye Color Self-Leveling Camera Available



**ProCam DVD Ultra
with Reel & Optional
Battery Pack Kit**

**Optional Rechargeable
Battery Pack Kit Includes:**

- (1) 14.4 V NiMH Environmentally Friendly Battery
- Dual Bay Fast Charger with Carrying Case
- Additional Batteries Available
- Charges on Both AC & DC



UEMSI
PIPELINE CLEANING & TELEVISION EQUIPMENT

Corporate Office: 1.800.666.0766 • Fax 1.800.691.0031
www.uemsi.com • E-mail: info@uemsi.com

We Accept:



See UEMSI in
Louisville



Booth 3218

**DEWATER FOR PENNIES PER GALLON
WITH AN **ALAR****
708-479-6100



**Best Technology
For Grease
Wastewater**

ALAR Auto-Vac®

- Over 1,500 Installations Worldwide
- Permit Assistance Available
- Turn Key Systems Available
- Minimal Operator Attention
- Rentals Available
- Trailer Mounted Units Available
- Financing Available

Analytical Test Results (Industry Average)

Parameter	Before	After
Grease	880	<2
FOG	1300	17
TSS	4300	360
BOD	360	17
Specific FOG	790	9
TSS	1100	1.6
BOD	5500	430

Alar Engineering Corp.
Family Owned and Operated
Made In USA Production
Offices in US, Canada and UK
65,000 sq. ft. Illinois Based
Headquarters featuring:
• Sales • Engineering
• Laboratory • Production

Comparison - Solids By Weight To Landfill
(Based on 10,000 Gallons with 4% Raw Solids)

Alar Auto-Vac	Roll Press	Gravity Separator
4 tons	12 tons	16 tons

NEW
Interactive CD
Available
Call For Your Copy
TODAY!!

Alar Engineering Corporation

9651 W. 196th Street - Mokena, IL 60448
Phone: 708-479-6100 Fax: 708-479-9059
E-Mail: info@alarcorp.com www.alarcorp.com

1-800-243-1406
Diesel and Electric
DREDGES



#5195 & 6195

LWT LLC

PIT HOG™

WWW.LWTPITHOG.COM



"Built to do the work for you."

(1) - 2001 International 8100, ISM Cummins (280 HP), 60K miles, 10 spd. Trans., 76" dia., 3,150 gal., 5/16" Shell, Full Tilt/Open, 4" intake, 6" discharge, RCF Fruitland 500 pump

(1) - 2008 Peterbilt 340 with a PX 8 330 HP and a 10 spd. Eaton-Fuller transmission, 76" dia., 3,150 gal., 5/16" Shell, Full Tilt/Open, 4" intake, 6" discharge, RCF Fruitland 500 pump

(1) - 2001 International 9100, N14 Cummins (370/425 hp), 70K miles, 10 spd. Trans., 72" dia., 3,150 gal., 1/4" Shell, Full Tilt/Open, 4" intake, 6" discharge, RCF Fruitland 500 pump

Call Now To Order

ASME DOT 407/412 CODE UNITS

Mounted on a new or used Peterbilt, International or Freightliner

- ◆ (1) - 76" dia., 3,150 gal., 5/16" Shell, Full Tilt/Open, ready to be mounted*
- ◆ (1) - 76" dia., 3,150 gal., 1/4" Shell, Full Tilt/Open, ready to be mounted*
- ◆ (1) - 76" dia., 3,000 gal., 5/16" Shell, Full



Tilt/Open, ready to be mounted*

- ◆ (2) - 72" dia., 3,150 gal., 1/4" Shell, Full Tilt/Open, ready to be mounted*
- ◆ (2) - 76" dia., 3,000 gal., 1/4" Shell, Full Tilt/Open, ready to be mounted*

Call for quotes

* Tanks can be shipped.

MANUFACTURER OF DOT 407/412 TANKS

For more information
contact L.C. Sutton



Global Vacuum Systems, Inc.

32804 US 290 West

Hockley, TX 77447

Toll Free: 800-843-0866

Email: info@globalvacuumsystems.com

Web: www.globalvacuumsystems.com



DENVER TRUCK SALES

Nobody Beats Our Quality!



Complete Line of Pumps and Parts



1996-2001 Western Stars

435 Cats, Jake, 18 speeds 46,000 LB rears on Hendrickson air suspension. New 3360 gallon tank, HXL-400 Masport pump, serviced and checked.

From \$64,950 plus F.E.T. on the tank

1997 KW T-800 Series

60 Detroit, Jake, RTLO-16713 transmission, RT46160 46,000 LB 4.33 ratio, New 3360 gallon tank, Masport HXL-400 pump, New paint serviced and checked.

\$66,950 plus F.E.T. on the tank



1996 IHC 9400

14,000 LB f/a 3406 Cat, Jake, 15 speed transmission, 46,000 LB rears hendrickson air suspension. New 3360 gallon tank HXL-400 pump serviced and checked from

\$62,950 plus F.E.T. On the tank



2001 Freightliners FL 120

C15 475 Cat, Jake, RTLO-18918 trans, RT46160 on Hendrickson spring suspension, 4-way locks. New 3360 gallon tank HXL-400 pump

\$79,950 plus F.E.T. on the tank

Easy Financing and Lease-To-Own WAC!

Denver Truck Sales • 5293 Vasquez Blvd. • Denver, CO 80216

Phone: 303-291-0960 • Fax: 303-291-0244 • www.denvertruck.com

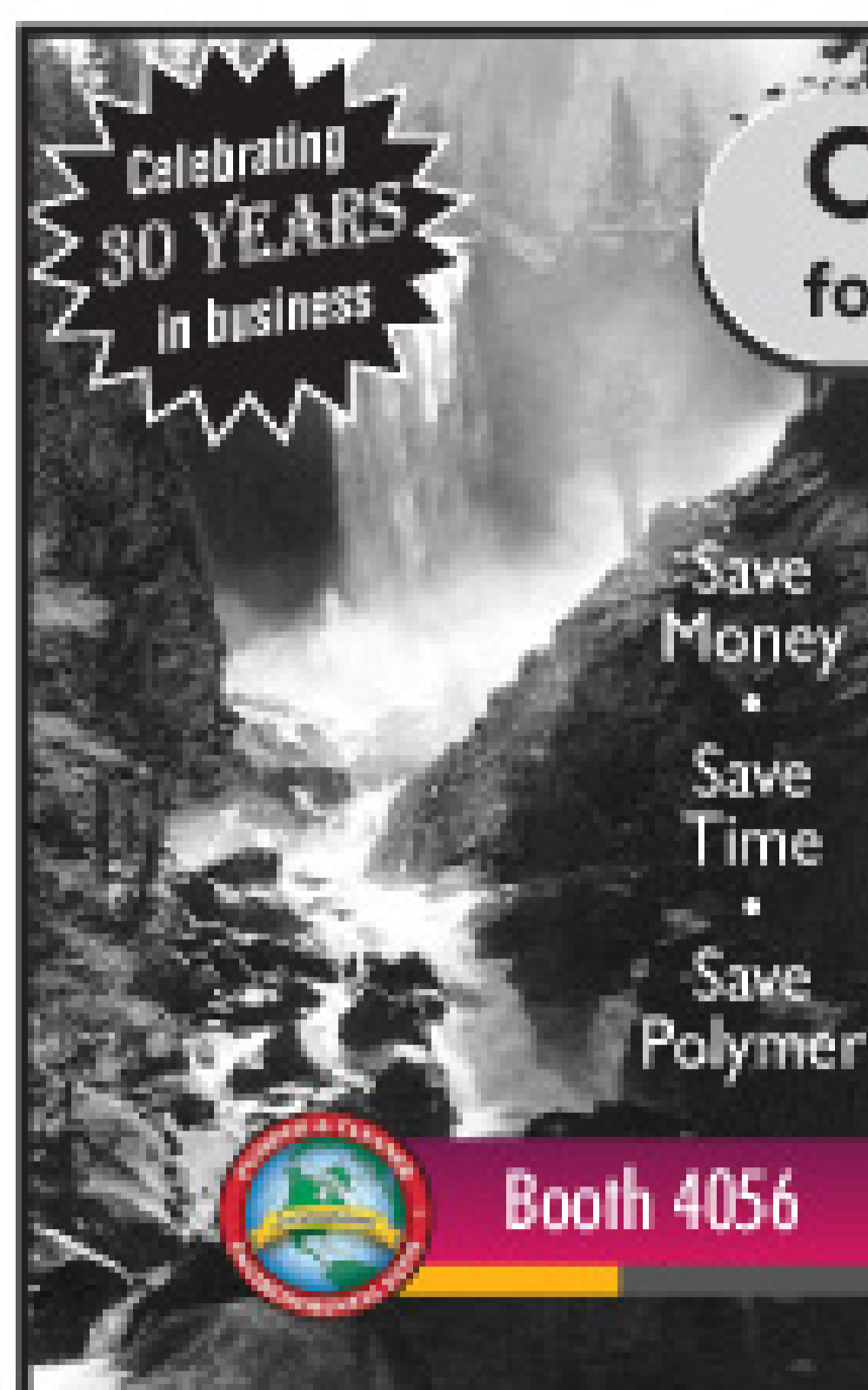

Celebrating 30 YEARS in business

Coagulants and Flocculants for Septic, Grease, Municipalities and Industry

- Dewatering polymers for all dewatering equipment
- All forms: Dry and Emulsion
- Variety of packaging sizes to meet customer needs
- Both East & West coast shipping points
- Expert technical staff
- Specific solutions for our customers

Call Toll-free: 877.771.6041

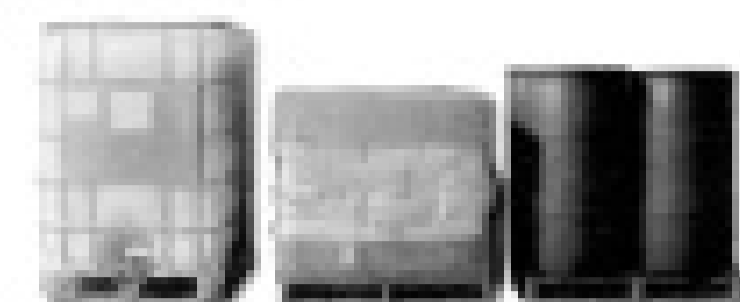

Aqua Ben Corporation

1390 N. Manzanita St. • Orange, CA 92867

www.aquaben.com • sales@aquaben.com



Booth 9211



NEW PRODUCT!
6 Gallon Pail

No Form Super Concentrate

\$189⁰⁰

Formaldehyde Super Concentrate

\$109⁰⁰

Freight Paid

plus FREE Intro Perfume Sprayer Kit

A&L Systems

25415 Glendale
Redford, MI 48239
Phone: 313.533.7100 or
800.592.5253
www.a-and-l-systems.com

Heavy-Duty Lighting & Accessories

Automatic On/Off Motion Sensor

Now With Theft Deterrent Mounting Brackets
3 LED's for Greater Illumination



The battery operated LED Light automatically turns itself on when motion is detected by the built in sensor and turns itself off 30 seconds after you leave the area. Dusk to dawn sensor prevents daylight activation.

- White LED Lights
- Stop/Tail/Turn Lights
- LED Lighting
- LED Clearance Marker Lights
- LED Front Air Cleaner Lights
- Halogen Driving Light Systems
- Strobes • Revolving Lights • Flashing Lights
- Visor Lights • Remote Power Supply
- Traffic Safety • Bar Lighting • Alarms



Booth 10043



SOFTWARE FOR THE INDUSTRY Summit™ XP Service Profit Builder™

- Work Orders
- Dispatching
- Simplified Routing
- Instant Mapping
- Inventory Control
- Receivables
- Commissions
- Repeat Business
- History & Reminders
- Basics system starts at \$800
- Demos on line: www.ritam.com
- Demo DVD/CD also available
- Ask about our:
 - Fleet Maintenance software for vehicles, equipment, parts and services
 - Incentives software for employee productivity tracking
 - Sales Contacts software for salesreps

Celebrating our 25th Anniversary!



Voted Easiest to Use!

In the Portable Restroom business too?

Ask about our Summit™ XP Rental Profit Builder™ software

Ritam Technologies • 800-662-8471 • www.ritam.com

"Bringing Technology and Greater Profits to the Industry" ... Since 1981
Put our 25 years of experience to work for you

Refrigerator Magnets \$.43

Straight Line Setup FREE!

1-800-758-2743



Minimum 500

Call: Sholom
for pricing
Quantity Discounts



Booth 51

Pumper Truck Shape
Actual Size 4 1/2" x 2"

2-color Imprint

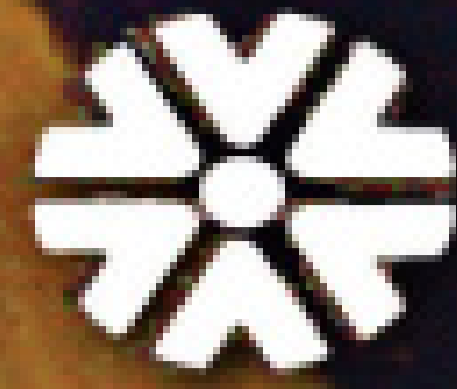

CENTER CAPITAL CORPORATION®

A Webster Bank Company*

Financing geared toward your business success.

THE INTELLIGENT CHOICE

FOR INNOVATIVE FINANCING SOLUTIONS

Environmental Equipment Financing Division

Financing Geared To Your Business Success!

The Intelligent Choice For Innovative Financing Solutions

Center Capital's Environmental Equipment Financing Division offers equipment leasing and financing services tailored to the unique requirements of the waste management and environmental industries. Unlike traditional lenders, our sales team has expertise in both financing and waste management. We understand the kind of payment plans that make sense for your industry. We understand the equipment. We understand the day-to-day business issues you face.

When you work with Center Capital, you're partnering with professionals who understand your business and what it takes to help it grow.

We Cover 50 States!

PAYMENT PROGRAMS

STRUCTURED TO FIT YOUR NEEDS

VENDOR VALUE-ADDED

PROGRAMS

APPLICATION PROCESS

SIMPLIFIED

MORE INFORMATION

CONTACT

Robert A. Marino
Sr. Vice President



Booth 185

Phone: 800-344-2224 • Fax: 215-542-1307
Website: www.centercapitalcorp.com

*Center Capital Corporation is a Subsidiary of Webster Bank, N.A., Member FDIC

J&J Chemical Expands National Sales Team

Michael Lackey and Joshua Carmichael have joined J&J Chemical's national sales team. Lackey joins the Midwest and Northeast divisions, and has 27 years experience in the portable restroom industry. Carmichael will be based in the company's Georgia corporate office, where he has worked the past two years.

AlturnaMats Acquires Mobile Mats

AlturnaMats Inc. has acquired Mobile Mats of Green Bay, Wis. Phil Schounard will continue to head Mobile Mats and operate out of the Green Bay facility.

JAG Names Senecal Director of Customer Development

Charles Senecal has been named director of New Customer Development for JAG Mobile Solutions Inc. He brings more than seven years of sales, development and marketing experience in the portable sanitation industry to his new position.



Charles Senecal



Jack Hoskins Sr.

Jack Hoskins Sr. Founded Bay State Truck & Trailer

Jack Hoskins Sr., president and CEO of Bay State Truck & Trailer Inc., Rehoboth, Mass., died Dec 9, 2007. He was 66.

Hoskins and his wife, Linda, founded the family trailer business in Pawtucket, R.I., in 1979 as Atlantic Tank and Chassis Co. The company took the Bay State name in 1985 when it relocated to Rehoboth. The company services, sells and leases new and used trailers. The couple's sons, Jack Jr. and Erik, have served as service and sales manager respectively.

Hoskins was a Vietnam War Army veteran. He was also a member of the Board of Governors of the Rhode Island Kennel Club; member of the American Chesapeake Club; life sponsor member of Ducks Unlimited; life member of the Historical Society of Moultonboro, N.H., and Laconia, N.H., and a lifelong sponsor of the Boy Scouts of America.

Werts Promotes Anderson to Tank Truck Division Manager

Monte R. Anderson has been promoted to Tank Truck Division manager for Werts Welding & Tank Service. He has been with the company since 1999, working in sales, product development and as production coordinator. In his new role, Anderson will oversee all aspects of the Tank Truck Division, including manufacturing, production and sales.

Ditch Witch Redesigns Web Site

Ditch Witch has redesigned its Web site, www.ditchwitch.com. New features include equipment walk-arounds as well as a tool that enables users to configure units to their exact needs. The site also features detailed equipment specifications, easier navigation and extensive product photos.

Federal Signal Opens Long Beach Solutions Center

Federal Signal Environmental Solutions Group has opened its fifth FS Solutions center. The Long Beach, Calif., center will stock high-performance parts and accessories for the company's Guzzler, Vactor and Jetstream brands, as well as other makes and models of waterblasters and vacuum loaders. ■



FS Solutions center in Long Beach, CA.

ART'S TRUCKS & EQUIPMENT

View Our Entire Inventory
Online: www.artstrucks.com
3001 West Expressway 83
McAllen, Texas 78503
956.686.2326 Fax 956.686.5179
1.800.292.7007
www.artstrucks.com



1993 INTERNATIONAL 4900 Sewer Truck DT466-210HP Diesel Engine, Allison 653 Automatic Transmission, Air Brakes, 129,989 Miles, High Pressure Cleaner, Lot #2614793 - \$16,500

1995 FORD LT9000 Tank Hauler Truck DT Series 60 Diesel Engine, 10 Speed Eaton Fuller Transmission, Air Brakes, 21FT Flatbed, Lot #2715307 - \$27,500



1992 INTERNATIONAL 4900 Sewer Truck CUMMINS-280HP Diesel Engine, Allison 653 Automatic Transmission, Air Brakes, 142,685 Miles, VAC-CON MDL V390T, Lot #2715400 - \$43,500



1997 INTERNATIONAL 4700 Vacuum Truck INTL-175HP Diesel Engine, 5 Speed Transmission, Hydraulic Brakes 1200 Gallon Tank, Lot #2715246 - \$19,500



Supplying your Business for Seasons of Success



- **One-Stop Shopping**
Our wide selection of products makes shopping at several different places for all of your needs a thing of the past.
- **Very Competitive Pricing**
- **Huge Selection**
We carry a wide selection of portable restroom parts and accessories to take care of all your needs. Including toilet parts, pumps, pressure washers, hoses, valves, fittings, tank components, chemicals, dispenser systems, hand sanitizer, deodorizers and odor control products, engines, sink parts, cleaning supplies, and much much more.
- **Two Locations for Faster, More Economical Shipping**
Our warehouses in Utah and Georgia are strategically placed to service every state.
- **Custom Pump Trucks**
If you can imagine it, we can build it. We pride ourselves on our ability to work with our customers and design an efficient and effective pump truck designed around your custom applications.



**CALL TODAY for your
FREE product catalog!**



1-888-935-1133
www.toico.com

YOUR ONE STOP SOURCE FOR PORTABLE RESTROOM PARTS AND SUPPLIES

MTM Technologies presents the
PRO Solutions Toolkit and SPUD handheld

Improve Your Quality... Lower Your Costs



Portable Restroom
Tracking



Fleet
Management



Service
& Delivery
Confirmation



Performance Reporting
to Maximize Efficiencies

Integrated with
Total Activity Control
CLEAR COMPUTING

www.clearcomputing.com • 888-332-5327



#21003 & 21004

For more information
please contact us:
1.888.996.4276

www.microtargetmedia.com
techsales@microtargetmedia.com

MEGA Holding Tank

1250 Gallon Size



Options

Black Color • Level Alarm • Custom Fittings

LOW PROFILE Portable Holding Tank

100 • 210 • 300
Gallon Sizes

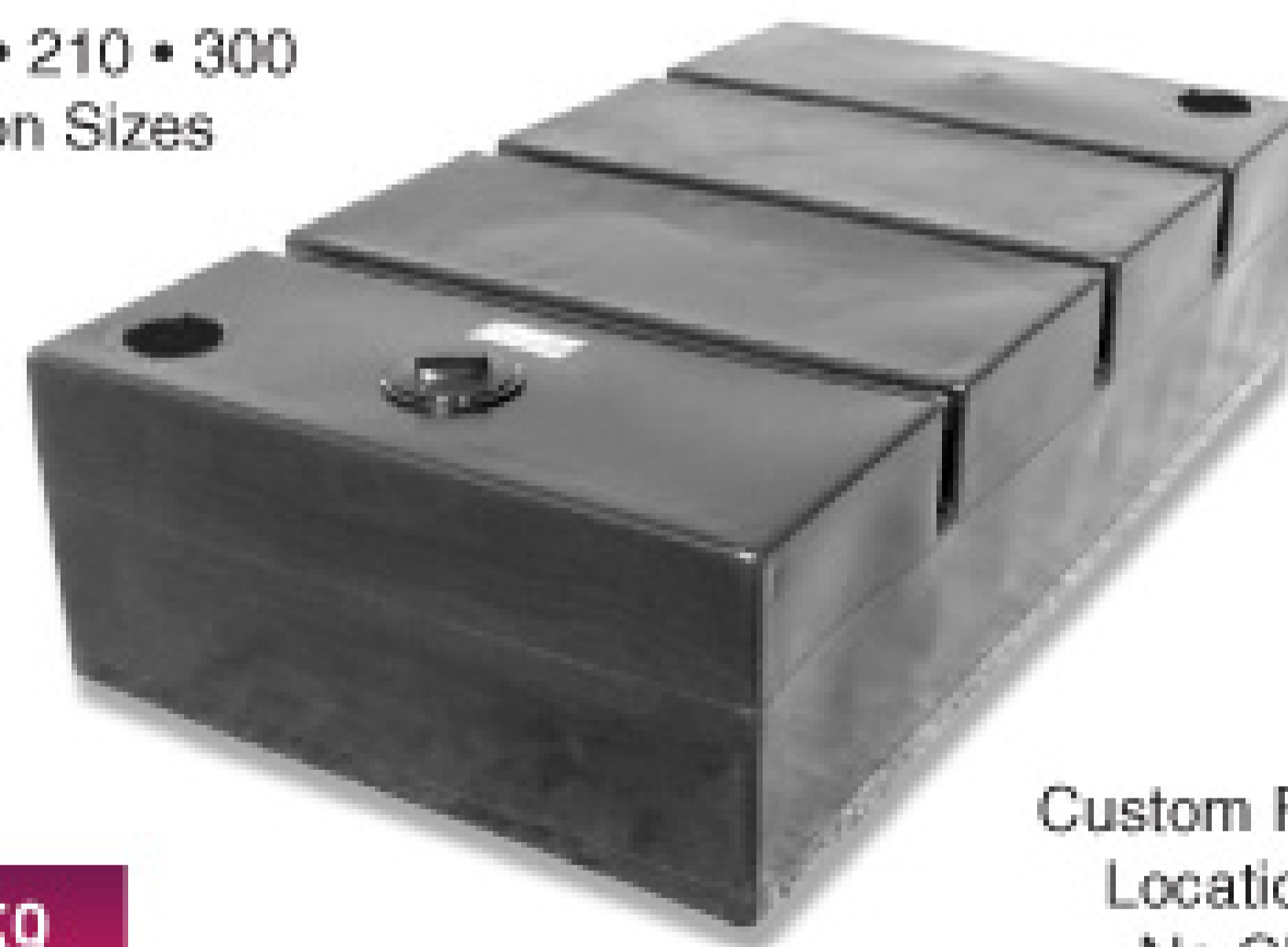

Custom Fitting
Locations at
No Charge



Booth 13059

On-Site Water System

OSW PLUS —

- Tough 65 gal. Tank
- Removable cover for easy cleaning
- 115V On-Demand Pump 3.5 gpm 45 psi
- Low water shut-off
- GFCI Protected
- Filter
- Ships UPS

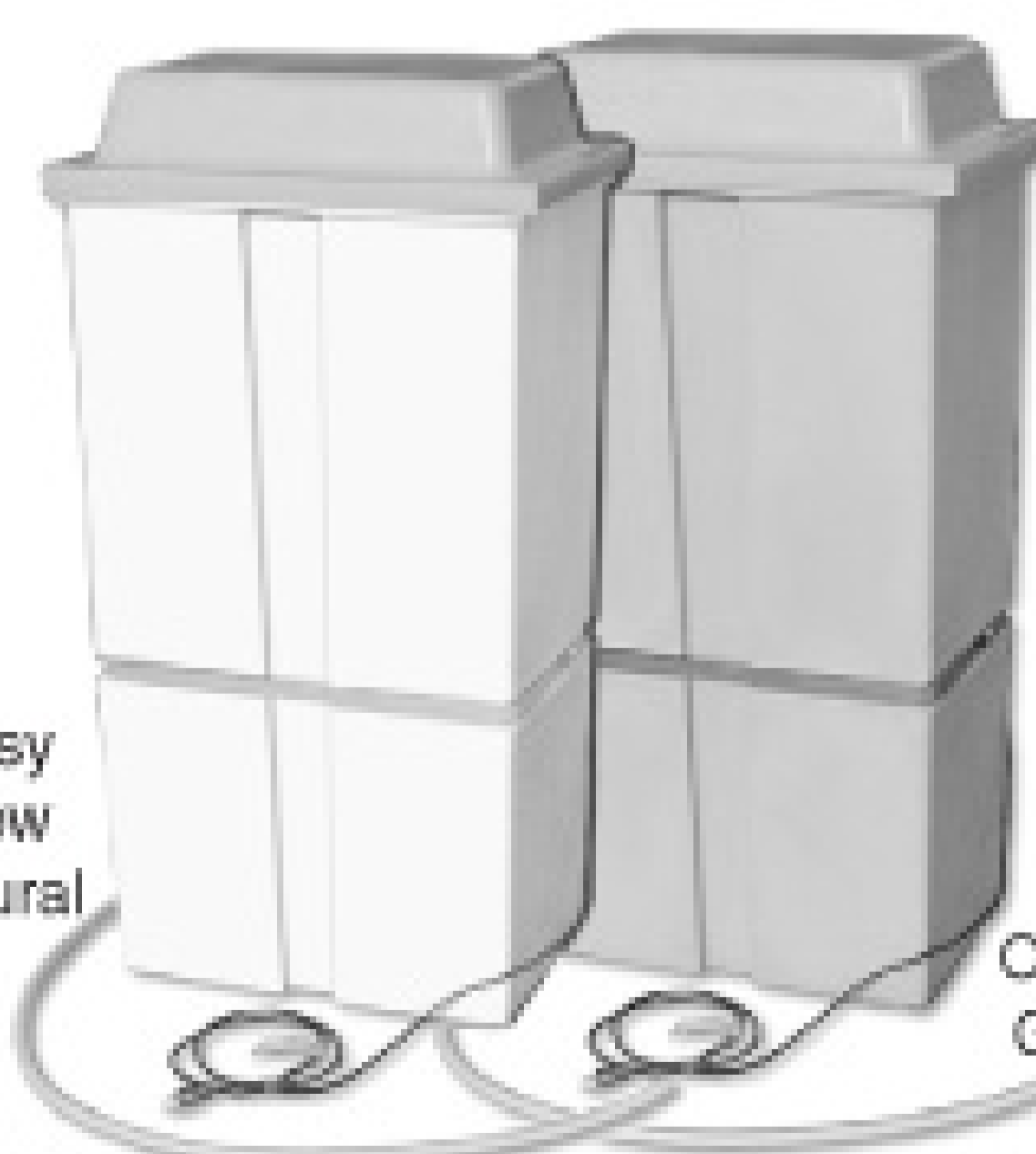

Easy
View
Natural

Office
Grey

OSW DELUXE —

- Add external fill connection w/float valve

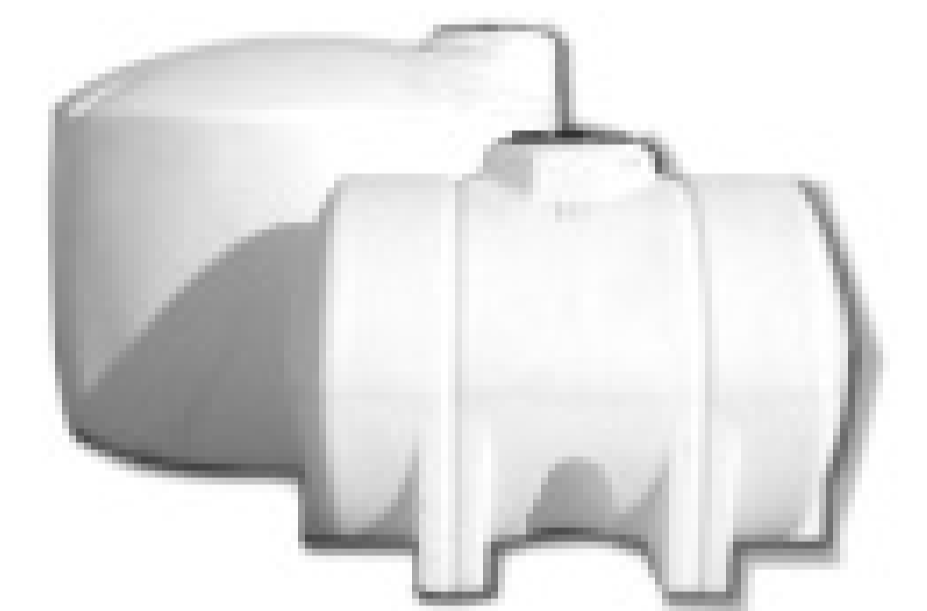

Bulk Storage and Transport Tanks



Septic and Cistern Tanks



Ball Valves and
Cam Lock Couplers

NORWESCO

Distributor Since 1987

Nationwide Shipping Points

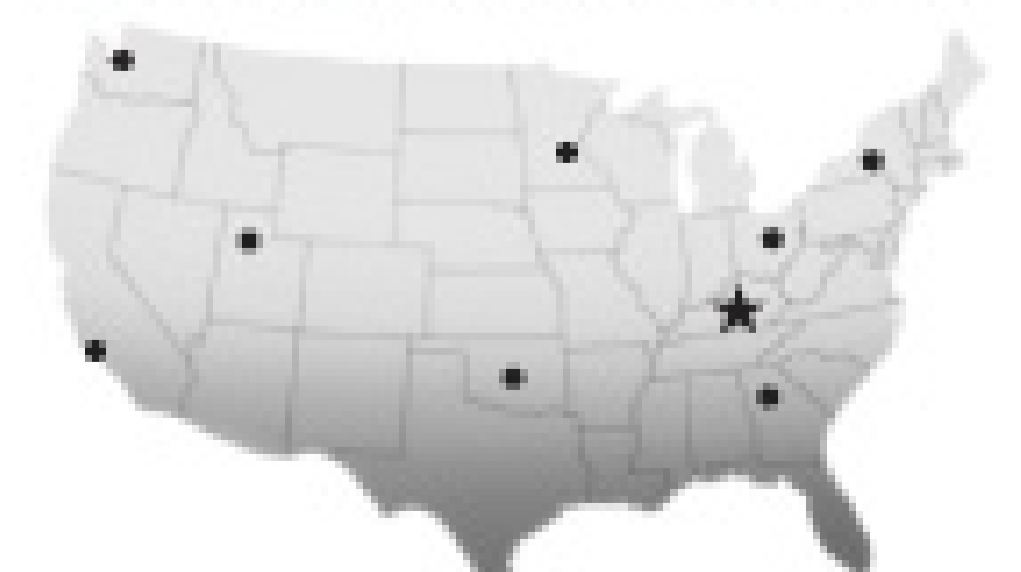

KentuckyTank

Plastic Tanks and Accessories

1-888-459-8265

www.kentuckytank.com

Mid Continent Truck Sales, Inc.

891 Adkins Hill Rd. • Norman, OK 73072 • 405-329-5365 • Fax: 405-329-5381 • After Hours: 405-288-6502 • www.vacuumtrucksales.com

Trucks - Trailers - Vacuum Tanks - Pumps



2001 IH 4700, DT466E, Allison auto, non-CDL, air brakes, new MEC 6500 vacuum pump, new 1100/400 vacuum tank.



Booth 5211, 5213, 6211



2000 Freightliner, Detroit 60 series (430/470 hp) w/fresh overhaul, 10-speed, double frame, new Wally 753LNHR vac pump, new 3400 gallon vacuum tank.



2004 Kenworth T300, Cat C7 (210 hp), 6-spd., 33K GVW, new Wally 753HR (350 cfm), new 2600 gal. aluminum vacuum tank, 2-yr. nationwide drivetrain warranty.



2000 IH 4700, DT466, Allison auto, non-CDL, new MEC 8000 vac. pump, new 1800 gal. vacuum tank.



1998 Freightliner FL60, Cummins 5.9 (210 hp), 6-spd., Masport H75V vacuum pump, General 47 series triplex, 1100/200 gallon vacuum tank.



LET US QUOTE YOUR NEXT VACUUM TANK!



1990 IH 9400, Cummins NTC350 w/fresh inframe, 9-spd., new Wally 753LNHR vac pump, 3500 gallon vacuum tank w/full opening rear door.

MID CONTINENT TRUCK SALES

manufactures and stocks all necessary components to complete your vacuum system. Whether it's pumps, valves, moisture traps, oil catch mufflers, pump frames, etc.

CALL US BEFORE YOU BUY!

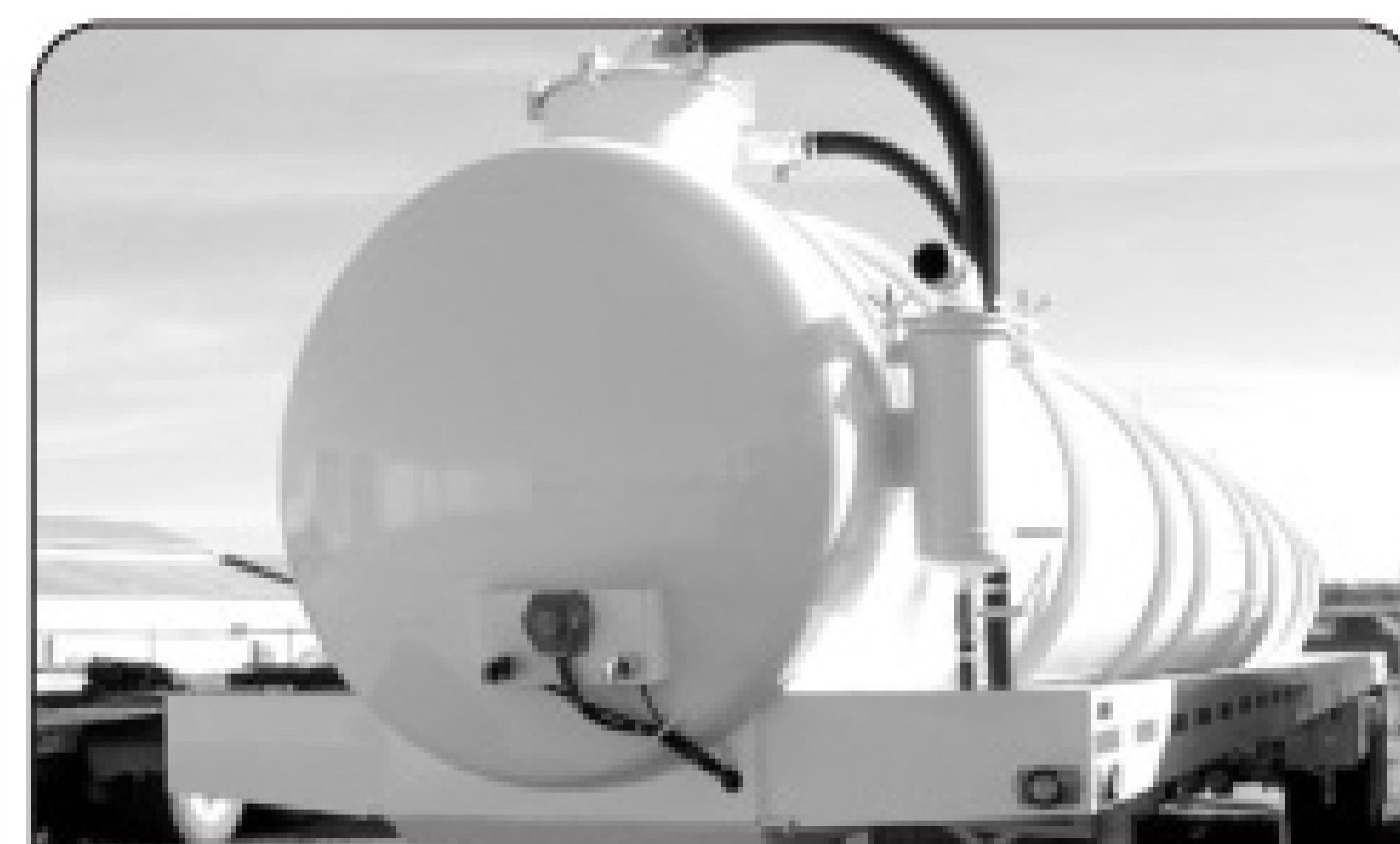

New Fluidmaster 5460 gal. vacuum trailer in stock. Also several used vacuum trailers in stock.

KSP
Pumps

Since 1946

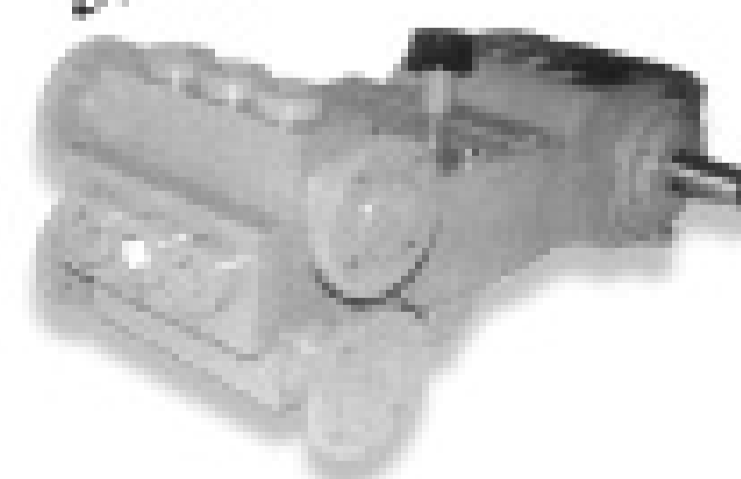

Masport

NVE

AUTHORIZED DISTRIBUTOR

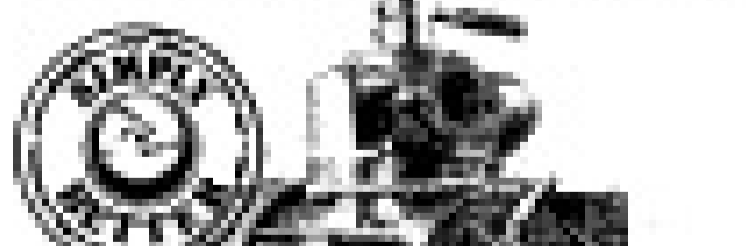

vallenstein
vacuum pumps

BOWIE



FLUID AND SLURRY
PUMPS

WE CARRY MOST BRANDS OF VACUUM PUMPS AND PARTS!



WE WILL BUILD TOILET UNITS TO YOUR SPECS!

Call DAVE PERRY for TRUCK quotations and CHUCK RODGERS for TANK quotations.

FEBRUARY Pumper CLASSIFIEDS

2008

- ▶ Advertising
- ▶ Aerators
- ▶ Bucket Machines
- ▶ Businesses
- ▶ Business Opportunities
- ▶ Cable Machines
- ▶ Computer Software
- ▶ Dewatering
- ▶ Drainfield Restoration
- ▶ Drain / Sewer Cleaning Equipment
- ▶ Dredges
- ▶ Excavating Equipment
- ▶ Hazardous Waste Units
- ▶ Hydroexcavation
- ▶ Jettors-Trailer
- ▶ Jettors-Truck
- ▶ Jet Vacs
- ▶ Lease Financing
- ▶ Locators
- ▶ Miscellaneous
- ▶ Parts & Components
- ▶ Pipeline Rehabilitation
- ▶ Portable Restrooms
- ▶ Portable Restroom Sinks
- ▶ Portable Restroom Tanks
- ▶ Portable Restroom Trailers
- ▶ Portable Restroom Trucks
- ▶ Positions Available
- ▶ Positions Wanted
- ▶ Positive Displacement Blowers
- ▶ Pressure Washers
- ▶ Pumps-Dredge
- ▶ Pumps-High Pressure
- ▶ Pumps-Submersible
- ▶ Pumps-Vacuum
- ▶ Pumps-Water
- ▶ Rodding Machines
- ▶ Roll-Off Containers
- ▶ Roll-Off Trailers
- ▶ Roll-Off Trucks
- ▶ Root Control
- ▶ Safety Equipment
- ▶ Septic Tank Forms
- ▶ Septic Trucks
- ▶ Service / Repair
- ▶ Slide-In Unit
- ▶ Sludge Applicators
- ▶ Tanks
- ▶ Tools
- ▶ Trailers- Vacuum / Tanker
- ▶ TV Inspection
- ▶ Vacuum Loaders
- ▶ Vanes
- ▶ Vehicle Tracking
- ▶ Wanted
- ▶ Wastewater Transfer
- ▶ Waterblasting

ADVERTISING

REMINDER POSTCARDS: Advertise full color postcards of your truck, service or products. Great marketing tool. Visit www.postcardprinting.com. Toll Free 1-888-334-4553. (PBM)

BUCKET MACHINES

GRADEBLADE — Convert your toothed bucket to toothless in 60 sec., NO tools needed, fast, inexpensive, fits backhoes, mini-excavators and large excavators. 1-888-372-8933 FREE DVD, literature. www.gradeblade.com. (PI4)

BUSINESSES

Septic Tank Pumping & Grease Business in Tennessee: Owner retiring, family owned, in business for 20 years. Two trucks: 2002 Peterbilt, 3,000 gal. tank; 1999 Chevrolet, 2500 gal. tank, garage kept and regularly maintained. Great opportunity for growth. \$160,000 last year; \$200,000 this year. Residential & commercial. \$250,000. 865-579-5699. Ask for Bob or Patti. (P2)

Business for Sale: Portable Toilet Business located in Northeast Florida. 200 toilets, 2 trucks and 1 trailer. All units and equipment in excellent shape. More info., call 904-237-0941. (P2)

FOR SALE: Septic and Portable Toilet Business located in Holland, Michigan. 10 toilets, 2 sinks, 1 truck. \$5,000 buys all! For more info. call 616-548-5128 or email me: smscamaro75@yahoo.com. (PT3)

FOR SALE: Northern New Jersey septic installation and pumping business. Company grosses average \$400K/yr. 2001 Sterling 2800 gal. pumper, 2 excavators, dump truck, low boy tractor trailer, 2004 Mitsubishi box/utility truck stocked with all tools and fuel tank. Work already in pipe-stream. Loyal client base and excellent referrals. Owner relocating. Any reasonable offer considered. Serious offers only please! Call 973-332-5374 for details. (P2)

BUSINESSES

MINI-BIODIESEL PLANT ASTM B100 - Turnkey Factory 200,000 to 2 million gallons per year. 818-760-2823. www.stopxon.com. (P3)

FOR SALE: Septic pumping business with portables located in Tomahawk, WI. 36 years in business. Owner wants to retire. \$220,000. Call VR Business Brokers. 715-833-1510. (P2)

LOOKING TO PURCHASE: Septic and/or Portable Restroom Business around the Charlotte, NC area. Interested sellers please call 704-929-1845. Email mike@arisrentals.com. (PT2)

FOR SALE: 23-year-old restaurant service company specializing in hood system cleaning and ceiling restoration. Serving WV, OH and KY. Large loyal customer base. Grossing average \$500,000. All vans, equipment and experienced service techs in place. \$300,000. Will train. 304-372-2158. (CP7)

FOR SALE: 20-YEAR ESTABLISHED PORTABLE TOILET BUSINESS IN WV. ± 350 Tuff Johns, ± 50 Satellites, some fiberglass, 6-8 holding tanks (mobile office), 4 toilet hauling trailers: 2006 F550 w/100 gal. water, 250 gal. waste; 2005 F550 w/250 gal. water, 500 gal. waste; 1985 Mack pumper w/jetter, 2500 gal. waste, 1000 gal. water. 250-300 toilets on rental now. Gross \$350,000 yearly or more. Call 304-472-7962 for Tammy. (P3)

FOR SALE: Septic and Portable Toilet Business located in White Mountains, Arizona. 150 toilets, 2 ADAs, 3 trucks. For more info, respond to: 11448 East Monte Ave., Mesa, AZ 85209. (PBM)

BUSINESSES WANTED: Septic pumping, grease trap, drain cleaning and other ancillary businesses wanted. We are buying well run businesses in New England, Mid-Atlantic and Florida. All opportunities will be given proper consideration. Confidentiality ensured. Will move quickly for the right opportunity. Serious inquiries only. Please contact Richard Bedard @ 617-326-3344 or rbedard@bwseptic.com. (PBM)

BUSINESSES

Well-established portable restroom business for sale in Massachusetts. Locally owned and operated for ten years with excellent customer base. Annual sales over 1 Million. Seven service trucks with 1600-2000 gal. tanks; one 10 toilet delivery truck; three delivery trailers; two 8000 gal. tank trailers; one Ford L9000 tractor. Over 1000 portable toilets plus Flushable, Handicaps, Hand-washing Stations, VIP and Holding Tanks. 60% of inventory rented. Serious inquiries to toilets26@comcast.net. (PT2)

SEPTIC PUMPING, INSTALLATION AND POTTYHOUSE BUSINESS: Central Illinois. Established 12 years, 2,000+ customer base. Great for father/son or husband/wife. Most work in 30-mile radius. \$115,000. OR buy name, phone number and customer files for \$100,000. OR buy into corporation for \$50,000, will train and get you licensed; and you complete the buy-out one year from buy-in. 217-417-0374. (CP2)

Long Island, New York: For Sale: Cesspool, Septic, Sewer and Drain Cleaning Company For Sale. 2 pump trucks, 2 porta-pottie trucks (service and delivery). Quality workmanship, has established 3000+ loyal customer base. Great opportunity for right person. Jump in on busy season! Money maker! Debt free! Office/shop/yard also available. Call for more information. 631-472-0677. (PBM)

BUSINESS OPPORTUNITIES

Mr. Rooter franchise for sale in central N.J. Excellent potential for expansion. Will temporarily hold N.J. license. \$275,000. Call 609-868-9024. (CP3)

Attention PolyJohn Owners: Receive a free CD-Rom of our products to use in your company marketing efforts. Ask your PolyJohn business coach in your area to send you this material today. 1-800-292-1305 Kell. (PBM)

BUSINESS OPPORTUNITIES

WWW.ROOTERMAN.COM. Franchises available with low flat fee. New concept. Visit web site or call 1-800-700-8062 x26. (CPBM)

NORTHEAST OHIO. Looking to acquire Septic/Jetting company. Expanding to Ohio. Please send letter to: Attn: Purchasing, P.O. Box 4834, Mooresville, NC 28117. (PT2)

National Grease Recycling Inc. Let us teach you how to recycle restaurant's waste fryer grease and oil (yellow grease) only. **No trap grease.** Big \$. Over 30 yrs. experience. Will guide you through complete process from collection to processing to marketing to end users. Don't lose your trap business to competitors that offer both services. Call for information. Dewey Walker. 813-752-9535 or 813-758-2552. (PBM)

COMPUTER SOFTWARE

Pumper Plus Billing Software: Regularly \$795. Mention this ad in Pumper.com and purchase for only \$595. Pumper Plus is a billing software package from Galaxy Systems, www.galsys.com/pumperdemo.asp, that handles billing for septic pumping and portable toilet service-type companies. Inquire at solutions@galsys.com or call 800-985-3029. (PBM)

DEWATERING

One Green Mountain Technologies 40-yard dewaterer container. Completely rebuilt. Spare parts included (screenings). \$20,000. One Lely Rotary Trash Screener. Bought two years ago, never used. \$7,000. Pictures available. Located Central NH. Call 603-476-5557. (P3)

Buy - sell - trade - lease: Filter presses, belt presses, vacuum filters, filter cloth, dewatering bags, tanks, mixers and more! Call Waste Treatment Equipment Specialties at 440-808-8844. **www.wescoequip.com.** (PBM)

PLACE YOUR AD ONLINE AT www.pumper.com - IT'S ALWAYS THERE TO MEET YOUR BUSY SCHEDULE

DEWATERING

30 yard, 7,000 gal. capacity grease or septic dewatering box, 2 meter stainless belt press, 2 polymer system. Excellent condition. Can email pictures. Call Oregon 503-577-7223. (P2)

30-yd. Spectrum turbo fixed-media dewatering box. Blue with tarp. Demo unit used once. \$24,500. Call: 405-360-2100. (P3)

2002 16' MAXIMIZER. Like new, used for two summers. \$30,000 OBO. 937-746-6361. Ask for Scott. (P3)

Two 40-yd. dewatering boxes and one polymer mixing and pumping units with Seepex sludge pumps. 5 years old. Excellent condition. Asking \$20,000/box and \$25,000/pumping unit. Call 1-506-672-2100. (PBM)

DRAINFIELD RESTORATION

1997 TerraLift: See At The Show. Comes with custom trailer. Makes more money than anything else I've ever owned. \$12,500. Scott 574-292-1059. (P2)

DO YOU OWN A TERRALIFT MACHINE? Do you need help with machine operation or sales and marketing programs? We also have the beads. Over eleven years in the business. Toll Free 1-888-252-1006. (P2)

TERRALIFT: 2001 Terralift, 6 foot probe, 450 hours. Runs like new. \$15,500. 336-362-3574 anytime. (P2)

2000 TERRALIFT, 368 hours, one 6-ft. probe. \$18,000 OBO. 314-486-1967 or 573-384-6322. (P12)

DRAIN/SEWER CLEANING EQUIPMENT

LIKE NEW JETTER (Cam Spray), 4,000 psi, 7 gpm, 24 hp, 12.5 hrs. with 250' 1/2" cleaning hose and additional 300', electric reel, Root Rat nozzle. \$13,500. Call Horacio 661-478-2947. (P2)

EXCAVATING EQUIPMENT

2004 and 2006 Super Products Mud Dog Hydroexcavators for sale or rent. Call 330-270-9900 ext.3. (P3C4)

GREASE UNIT

1996 International 4700 cab and chassis with a 1,000 gallon, 2-compartment (1200 waste/600 water) c/s vacuum pressure tank with jetting system. (Stock #2362V) **www.VacuumSalesInc.com, (888) VAC-UNIT (822-8648).** (PBM)

HAZARDOUS WASTE UNITS

2007 Sterling LT9500 with a new Presvac 3,500 gallon c/s DOT certified 407/412 vacuum tank dump type with full open rear door. Presvac PVB750 vacuum pressure pump (Stock #13294A). **www.VacuumSalesInc.com, (888) VAC-UNIT (822-8648).** (PBM)

2009 Freightliner 120 steerable tri-axle with new Presvac Powervac 3,800 cfm, DOT 412, wet/dry vacuum unit. 3,200 gallon tank with full open rear door with top loading boom. 450 hp MB engine with aluminum wheels and fully loaded. Buy or rent. KLM Companies/KLM Rentals Inc. Call 781-934-5437. (P2)

1994 Mack with a 4,400 gallon 2 compartment DOT certified unit. (Stock #5371C) **www.VacuumSalesInc.com, (888) VAC-UNIT (822-8648).** (PBM)

2008 Peterbilt 340 with a new Presvac 3200 gallon (US), C/S, DOT certified, full open rear door, dump-style unit. (Stock #13306 A&B) *In production.* **www.VacuumSalesInc.com, (888) VAC-UNIT (822-8648).** (PBM)

2001 Freightliner C120 can and chassis with a new Presvac 3,200 gallon DOT 407/412 certified vacuum pressure tank. (Stock #13329V) **www.VacuumSalesInc.com, (888) VAC-UNIT (822-8648).** (PBM)

ATTENTION: Fleet of Mack vacuum, emergency response service trucks for sale/trade by owner. Tanks and misc. pumping equipment. 417-619-5111. (PBM)

New Presvac 5,500 gallon, C/S, DOT, vacuum tank trailer. (Stock #13325) **www.VacuumSalesInc.com, (888) VAC-UNIT (822-8648).** (PBM)

JETTERS-TRAILER

2001 Spartan model 798 high pressure jet, 4000 psi, only 142 hours, very good condition. \$17,500. 330-539-6823. (CP2)

JETTERS-TRAILER

1993 SECA model 747 4000 trailer jet, 4 cyl. diesel, Myers pump, 18 gpm, 4000 psi. Was a city owned unit. 714-639-8352. **www.empireequip.com.** (CPBM)

American Water Blaster Model WBD90. Delivers 10 gpm @ 10,000 psi. Detroit diesel 353 with Rockford PTO and stainless steel FE-85 Triplex mounted on a trailer. Well maintained, very good working condition. Asking \$14,000. Call 231-218-5398 with questions or e-mail roe@magnumsolvent.com. (CP2)

JETTERS-TRUCK

2001 SECA truck jet, Myers 35 gpm, 2000 psi water pump, 1000 gal. plastic water tank, new paint. Was a city owned unit. Located in Dallas. 972-938-1905. **www.empireequip.com.** (CPBM)

2003 Sterling LT7501 with a VacCon Model VPD4216LHA/ 1300 combination vacuum jetter unit. (Stock #4648C) **www.VacuumSalesInc.com, (888) VAC-UNIT (822-8648).** (PBM)

New PipeHunter Model 38T44 jetting unit, trailer mounted unit, w/335 Poly water tank, 4,000 psi @ 25 gpm, 600' of hose and attachments. **IN STOCK!!! www.VacuumSalesInc.com, (888) VAC-UNIT (822-8648).** (PBM)

1997 Sreco HV 2000 truck jet, 65 gpm, 2000 psi water pump, 1500 gallon aluminum water tank. Was a city owned unit. Located in Dallas. 972-938-1905. **www.empireequip.com.** (CPBM)

2006 Chevy C5500 with a Pipehunter with a Jet Eye camera and vacuum system. (Stock #13234) **www.VacuumSalesInc.com, (888) VAC-UNIT (822-8648).** (PBM)

Vactor water jet on a 1998 Ford F-800, Cummins diesel, 17,338 miles, automatic, 1000 gallon water tank. Needs water pump. This truck is like new. 972-938-1905. **www.empireequip.com.** (CPBM)

JET VACS

1999 Vac-Con, 12 cubic yard on International, factory rebuilt engine 2005, running complete, 63,436 miles, 80 gpm, 2000 psi, PD, Spicer trans., articulating hose reel. \$98,000. 610-692-9160. (CPBM)

JET VACS

10/2002 Vac-Con on a 2003 Sterling, 8300 hours, 63,000 miles. 9-yard debris tank, 3-stage fan blower, 80 MPG Meyers/Cummins aux. \$107,000. 904 571-4688. (P3)

Vactor 2110 Mounted on a Ford L8000: Fold-down pipe racks, debris body flush-out. Call for many other options not listed. (Stock 1453). \$32,500. Call Joe 312-208-6373. (P2)

2006 2103 Vactor mounted on 2007 Sterling Acterra 4x2, auto, combo sewer cleaner, 500 gal. water tanks, 3.5 yd. debris tanks, PD blower, hydraulic pump 40 GPM @ 2500 PSI, 500' hose reel, 6' tubes, brand new condition, 11,000 miles. No CDL necessary. \$134,000. 561-718-2736. (CP3)

2000 Aquatech B-15 on a Sterling L9513, PD blower, 65 gpm, 2000 psi pump, rear hose reel, 1500 gallon water tanks, 15 yard debris tank. Was a city owned unit. Located in Dallas. 972-938-1905. **www.empireequip.com.** (CPBM)

1999 Vactor 2100 on a Sterling Chassis: CAT 3126 engine, Allison auto. trans., 80 gpm @ 2500 psi, accumulator, debris body flush-out, 4' extend. boom, fold-down pipe rack. (Stock 1445) Call Joe 312-208-6373. (P2)

1995 Vac-Con, reconditioned by Vac-con 2 years ago, 12-yard debris, 1500 gallon water, 80 gpm water pressure, 2000 psi, 74000 miles, runs good. \$64,000. 845-374-1161. (CPBM)

2001 Camel 200/10-yd. Ejector on Sterling LT7501. CAT 3126B, Allison MD3560, Myers 65 gpm/2000 psi, Dresser PD624. 120,000 miles. Well maintained. \$132,500. Call Eddie at 404-361-2738. (P2C3)

2001 Vactor: Domed rear door w/hyd. locks, hot shift blower drive, 8' hyd. telescopic boom, tela/rotating hose reel, debris body flushout, handlight w/bumper plug, folding pipe racks, street curb, retract. hand gun reel, low water alarm w/light. Call Joe 312-208-6373. (P2)

1998 VacCon V312THA on a Ford LT8000, 3-stage fan, 65 gpm, 2000 psi pump, extendible boom, articulating hose reel, 12 yard debris tank, new paint. Was a city owned unit. Located in Dallas. 972-938-1905. **www.empireequip.com.** (CPBM)

JET VACS

Jack Doheny Supplies Inc. offers a full range of late model combo units and DOT industrial vacuum loaders. Call us @ 1-800-3DOHENY. (CPBM)

1998 Vactor 2100: 1998 International model 2554 chassis, IH 530 E, 275 hp engine, Fuller RT8908LL trans., fold-down pipe racks, 80 gpm @ 2500 psi water sys., hydraulic rear door locks. (Stock 1444) Call Joe 312-208-6373. (P2)

1998 Vactor 2110 on a Freightliner FL80, 28,213 miles, 2-stage fan, 80 gpm, 2,000 psi pump off system accumulator. Was a city owned unit. Located in Dallas. 972-938-1905. **www.empireequip.com.** (CPBM)

1997 Ford Vac & Dig Model VND-S3 with air compressor, pressure washer, F series chassis, GVWR 33,000#. Price \$45,000. Call 503-969-9557 or 503-682-2723. (P2)

2002 VacCon V390LHA on a Sterling L7501, articulating hose reel, 10' extendible boom, 3-stage fan, pump-off system, 65 gpm, 3000 psi pump, new paint, excellent condition. Located in Dallas. 972-938-1905. **www.empireequip.com.** (CPBM)

Vac-Con model VPD4209THA on a 1997 Ford, **PD blower**, 4200 cfm, articulating hose reel, extendible boom, new white paint. Was a city owned unit. In excellent condition. 972-938-1905. **www.empireequip.com.** (CPBM)

Low hours, 1995 Vac-Con, 12-yd. debris, new water pump, newly rebuilt Roots blower, auto. trans., AC, tank vibrator, privately owned. \$65,000. 1-800-930-1123 or 954-981-2133. (CPBM)

LEASE/ FINANCING

North Star Commercial Credit: Commercial Loans for Trucks or Equipment. Flexible purchase programs to fit your budget. 21 yrs. in the industry. Contact **Tom Myers - 877-804-2274.** (CPBM)

Capital Partners: "Your One Stop Financing Partner" We have 31 years experience specializing in the liquid waste industry. Lease or loan options available on ANY new or used equipment. Contact Jim Stekl at 866-769-2345. (PT2C3)

BUY IT - SELL IT - PLACE IT - **www.pumper.com** - AVAILABLE ANYTIME, ANYWHERE, ANY DAY

LEASE/ FINANCING

BSM Financial Group is a nationally recognized finance company. We offer flexible payment schedules for all types of equipment new or used. Trucks, pumps, jetties, portable toilets, and software easily financed. We do first time start-ups, established businesses, and challenged credit. **Call Brett at 877-524-7972 or email brett@bsmfinancialgroup.com.** (PBM)

EQUIPMENT FINANCING WITHOUT ALL THE HEADACHES. *Our specialty is credit scores as low as 600; *Application only up to \$250,000; *Start-ups and young businesses up to \$130,000; *Any type or any make equipment new or used. Let us show you the money. We are in our 20th year. Call toll free at 866-259-5370. BSG Services LLC. (P3)

MISCELLANEOUS

DISCOUNT ALUMINUM: ARE YOU PAYING TOO MUCH? 1,000 lb. minimum quantity. 5052/5454/5083/5086. .063 - 5.0" thick. All widths. Contact Jayson. 1-888-540-0066. (PBM)

FULL OPEN DUMP TANK, 2000 gallons, mounted on 1987 Ford F700, diesel, 5 speed, 310 CFM vac pump, big tool boxes, same owner since 1989. \$8,900. 405-235-8600. (P4)

Top quality aerators at wholesale prices. We have replacement units for most name brands and also carry Linear Regenerative Rotary Vane pumps. Flagg Air, Gast, Thomas, FPZ, Secoh, Medo and more. Call a company that understands aerators and aeration systems. Septic Services Inc. 800-536-5564. (CPBM)

FOR SALE: 1,000 gallon dual compartment septic tank form, top pour, excellent condition. \$5,000. Ph: 724-475-4625. (P3)

PARTS & COMPONENTS

For Sale: Used Hibon Blower 9100 type SIAV100, used Hibon Blower STAV501, (2) used vane pumps #31817. 330-270-9900 ext. 3. (P3)

PORTABLE RESTROOMS

Excess PolyPortable units in good to very good condition in North Georgia. \$175 each. E-mail toilets 4sale@bellsouth.net. (P2)

New and used Synergy & Satellite portable toilets. Also various used portable toilet service trucks for sale. Call Tony 256-310-4714. (PT2)

26 Blue Satellite Tufways. Very good (\$250) to excellent (\$350) condition. Two Blue ADA units \$300 and \$800. Quantity discount. Southern NM. 505-443-3805. (P2)

USED PORTABLE TOILETS: In Chattanooga, TN. Satellites, PolyPortables, and PolyJohns ready to rent. Nearly 200 units to choose from. \$195 each. Can deliver 24 units at a time @ \$2.25 a mile. Also available 100 Synergy Ultras VIP toilets used only for special events, like new. 30 units are 6 years old and 70 units 5 years old. Sold only as group for \$32,000. Call Charlie 423-894-9994 or e-mail charlie@pitstopportables.net. (PT3)

Over 500 grey PolyJohn units next to new condition. Starting at \$200 each. Ready to earn you money! Located in SW Florida. Call 888-697-6943; erin@amberjack-inc.net. (PT5)

FOR SALE: 200 plus PolyJohn portable toilets. Job site ready. 100 aqua; 100 tan. 281-351-5921 or 281-541-7448. Houston. (P2)

FOR SALE: Used portable toilets: Polysans, Hightechs models in Northern Ohio. \$100 to \$200 each. 419-466-1349. (PT5)

FOR SALE: PORTABLE TOILETS: 500+ PolyJohn standard tan units; 500+ PolyPortable standard tan units; poly skids, white tops & corners. Good to very good, excellent condition. Save 50-60% off cost new. Quantity order discounts. Call Bob Sartor in Fla. at 352-796-4540. For serious buyer, can arrange shipping. (PTBM)

Portable Toilets: Poly constructed, molded seat, urinal, latching door. Handicap accessible units available. New and used. CCI/Brian Touey 805-896-3777. (PBM)

Over 600 PolyJohn units 1-2 years old. Starting at \$300 each. Minimum purchase of 26 units. 772-562-4604. kim@reliablepolyjohn.com. (PBM)

PORTABLE RESTROOMS

PORTABLE RESTROOMS: Used PolyJohn Fleet unit portable toilets. Brown in color. Good condition. \$150 each. Volume discounts. Call John at 352-266-4036 or email john@floridaexpress.us. (P3)

PORTABLE RESTROOM SINKS

(4) PolyJohn 2-person sinks, (27) PolyJohn 4-person sinks. All have soap dispensers and paper dispensers. Ready to go on a job site or festival grounds. All must go. \$250 each. 989-746-0009. (P3)

PORTABLE RESTROOM TANKS

500 gallon waste only tank. Ready to use. Battioni pump w/8 hp Kohler, steel tank. \$5,000. N.E. Texas. 903-455-3220. (P2)

100 new and slightly used PolyJohn tanks for sale. Buyer must pick up or arrange transportation. Chicago area. Email for pics: portableservicesinc@gmail.com. Eric 815-838-7000. (PT2)

Single or multiple compartment tanks. Choose mild, stainless, or galvanized steel. Capacities from 100 to 6000 gallons, any diameter. Parts and accessories to build your own and save money. 800-545-0174. www.tanksandpumps.com. (PBM)

PORTABLE RESTROOM TRAILERS

(31) Used restroom trailers, some need repair. Great winter project! Located in Portland, OR. Send e-mail for photos and details. These trailers will be sold cheap and quick! E-mail sanipot@comcast.net or call Bruce Phillips at 503-519-6959. (PT3)

RESTROOM TRAILERS FOR SALE: New in 2007. Various sizes available. Ready for immediate use. 410-266-7812 or go to www.restroomtrailers.org for pictures and details. (P4)

Restroom Trailer - Platinum Series: 30', new and used. Women's - 4 stalls, 2 sinks. Men's - 2 stalls, 3 urinals, 2 sinks. CCI/Brian Touey 805-896-3777. (PBM)

PORTABLE RESTROOM TRAILERS

Nu Concepts VIP 2-unit, \$3,500 & 4-unit, \$6,500. Double axle trailers. Two, nice equipment. 2-unit high capacity trailers, \$4,500 each. All trailers are in good condition, used for the movie industry. www.KKPV.com. 949-673-1999. (PT2)

1997 Ameri-Can 32' Restroom Trailer: 7 women's stalls, 3 mens stalls, 4 urinals. Ready to rent. 920-979-7713. (PT3)

Restroom Trailer - Gold Series: 32', new and used. Women's - 5 stalls, 2 sinks. Men's - 2 stalls, 2 urinals, 2 sinks. CCI/Brian Touey 805-896-3777. (PBM)

New and used **RESTROOM TRAILERS** available immediately. 8 to 34 foot luxury trailers. Comforts of Home Services Inc. 877-382-2935. (PBM)

PORTABLE RESTROOM TRUCKS

1999 F-550 Satellite, 600/350, 7.3 diesel auto, Conde Super 6 vacuum pump, tires 90%. \$18,000. 208-879-2800 Idaho. (P3)

2006 Ford F550 diesel, 950 gallon tank, 650/300 85,000 miles. Excellent condition-going to bigger truck. Ready to go to work. \$39,000 OBO. 707-888-8686 or 707-224-8258 Sam. (P2)

2005 F550 Ford, 2WD, 6-speed manual, 71,000 miles, white, 600 waste, 250 fresh, 12 volt water pump, Jurov vacuum pump, PTO-operated, good spare/tires, 2-unit carrier. Excellent condition. Mississippi. \$26,000. 662-803-1592. (P3)

1995 F-250 club-cab 4x4, 7.3 diesel, auto., 186,000 miles, 300/100, Conde Super 6 vacuum pump, 5 HP Honda engine, tires 75%. \$15,000. 208-879-2800 Idaho. (P3)

2000 Int. DT466 E 210 hp, 7-spd., AC & cruise, 170K, 2-compartment Presvac tank, rebuilt pump, 2-carrier, fold-down & ball hitch. \$16,500 OBO. Indiana 765-489-5559 or mobile 765-914-7583. (P2)

1998 International 4700 with a 1,500 US gallon, 2-compartment (1100/400 split), carbon steel, portable toilet service unit. (Stock #8734V) **www.VacuumSales Inc.com, (888) VAC-UNIT (822-8648).** (PBM)

PORTABLE RESTROOM TRUCKS

FOR SALE: 2005 Lanes portable restroom truck, C-5500 Chevrolet, 1000 waste, 250 fresh, Conde pump, fresh water pump. \$40,000. Please call 608-742-2648. (P2)

1998 Chev. 3500 dually gas, 4x2 auto, 500/200, M-2 vacuum/pressure, 8 HP Honda engine, 103,000 miles, tires 90%. \$15,000. 208-879-2800 Idaho. (P3)

1999 Freightliner FL60 with a 1000 waste, 250 mix, 250 water, stainless steel, portable toilet service unit. (Stock #2104V) **www.VacuumSalesInc.com, (888) VAC-UNIT (822-8648).** (PBM)

1996 International 4900 Series. White, DT466, 6-speed, A/C, P/S, A/B, 11R22.5 tires, 12 ft., 21 rear, Masport pump system, 1600 gal. sewage, 500 water, hose reel, (2) unit HD rack, 250,000 miles. Solid front-line unit. Very good condition. \$22,500 OBO. 352-796-4540. (PTBM)

2007 Chevy C7500 cab & chassis with a new 1500 waste, 500 water, aluminum portable. Call for pricing. (Stock #13289) **www.VacuumSalesInc.com, (888) VAC-UNIT (822-8648).** (PBM)

2001 4700 International, 25500 GVW, engine DT466, 7-spd./OD, A/C, air brakes, 3-compartment tank (450/850/200), M-10 Moro vacuum pump, spot lights, pressurized water spray down & fill, restroom carrier. Pictures www.acoinc.com/classified. Located Salt Lake City. \$38,000. 208-362-3193. (P2)

1994 International 4900 Series. White, DT466, 6-speed, A/C, P/S, A/B, 11R22.5 tires, 12 ft., 21 rear, Masport pump system, 1600 gal. sewage, 500 water, hose reel, (2) unit HD rack, 382,000 miles. Good standby/ spare service unit. Average condition. \$18,500 OBO. 352-796-4540. (PTBM)

1979 F-360 gas dually w/40,000 miles on new engine, 4-speed, 270/100 tank, new 8 HP Honda engine, new Masport M-2 vacuum/pressure pump, tires 90% plus extras. \$10,000. 208-879-2800 Idaho. (P3)

2004 GMC 5500 with a 1,000 US gallon, 2-compartment (700/300 split), carbon steel, portable toilet service unit. (Stock #0226V) **www.VacuumSalesInc.com, (888) VAC-UNIT (822-8648).** (PBM)

PLACE YOUR AD ONLINE AT www.pumper.com - IT'S ALWAYS THERE TO MEET YOUR BUSY SCHEDULE

PORTABLE RESTROOM TRUCKS

2000 F-550 Satellite, 600/350, 4x4 7.3 diesel auto, 136,000 miles, Super 6 Conde vacuum pump, tires 90%. \$20,000. 208-879-2800 Idaho (P3)

(2) 2005 335 Peterbilts, none CDL, 40,000 miles, like new, auto, air, 1500 waste/500 water with pressure washer, Progress tank, 2-unit carrier. \$68,000 each. 606-835-3459. (PBM)

2001 International 4900 Series. White portable toilet pick-up, delivery and service unit. 12 ft., 18 rear, Masport system, hyd. brakes, P/S, A/C, 10' deck with hydraulic lift gate. Unit carries 4 toilets. 38,000 miles. Excellent condition. \$28,500 OBO. 352-796-4540. (PTBM)

1999 Isuzu FTR, 190 hp, 6 cyl. diesel, 25,900 GVW, new Allison auto with 2-yr. warranty, Jay's Inc. 1,300 gallon 800/500 split, National 190 cfm vac. pump, Burks DC-10 wash down pump, heated dump valve, heated bucket fill, heated water pump, 60' hose reel, 2-unit toilet carrier, and more. 123,800 miles. \$35,000. Call Dale 708-878-4391. Located in Illinois. (PBM)

2002 International Pumper Truck: 4700 series, DT466, automatic, air brakes, 1200 gallon waste, 300 gallon fresh water, Masport 75 pump. CCI/Brian Touey 805-896-3777. (PBM)

2006 C5500 Chevrolet, miles in 40s with aluminum and steel tanks. Still under warranty. Slide-ins 600/250, \$9,000. Portable toilet transport trailers: 8, 10, 12, 14, 16, 20 haulers. New portable toilet trucks and new and used septic trucks. We stand behind everything we sell. Lane's Vacuum Tank Inc. 1-800-592-3308. (PBM)

PORTABLE SHOWER TRAILERS

2004 Ameri-Can Shower Trailer: 8 unisex stalls. On-demand propane hot water, fresh water hook up or 300 gallon on board. 920-979-7713. (PT3)

POSITIONS AVAILABLE

Experienced pumper/sewer machine tech, must have CDL and be willing to make this job a career. Well paid with excellent benefits. Cent. Illinois. 217-337-5996. (P2)

POSITIONS AVAILABLE

Established Waste Equipment Dealer seeks experienced waste water equipment Sales Representative in Mid-Atlantic region. Extensive travel with base salary, commissions, company car and expenses, and excellent benefits package. Call 757-328-7623 or forward resume to hr@midatlanticwaste.com. (P2)

Plumbing company in Florida seeking enthusiastic class B CDL tanker endorsement licensed pump/vac truck operator. Experience preferred. Medical, 401K, holidays, vacations. 1-800-930-1123 or 954-981-2133. (CPBM)

SBP, Inc., a Northwest Florida-based company, is seeking qualified personnel willing to travel. If you are experienced in cured-in-place pipe lining, high pressure cleaning and video and/or manhole or lift station rehabilitation using epoxy lining systems, fax your resume to 850-478-4507 to the attention of Wanda Murphy. (P1)

Looking to relocate to Sunny South Florida? Are you an experienced plumber or sewer and drain professional? Then you deserve to earn \$80K/year, \$5,200 bonus and a new truck and full benefits. Please call Don at 1-800-930-1123 or 954-981-2133. (CPBM)

LELY MANUFACTURING SEEKS AN INDIVIDUAL with strong Sales and Communication skills with 8-10 years experience in the Waste Handling Industry to oversee and actively participate in all aspects of Sales of Lely Waste Handling products. Interact with customers in the South Eastern regarding their Tank requirements and follow up during the entire sales process. Excellent salary, vehicle, expenses, and benefits. Submit cover letter and resume to plangebeeke@lely.com for confidential consideration, or Lely MFG, Inc, PO Box 789, Wilson, NC 27894. See our web site www.Lelyus.com. (T1P2)

PUMPS-SUBMERSIBLE

Wholesaler for Hydromatic, Zoeller, Myers, Liberty and ABS pumps. We also supply Grinder pumps and basins. Will help you size them. Septic Services Inc. 800-536-5564. (CPBM)

PUMPS-VACUUM

2 NEW NVE VACUUM PUMPS: NVE model 355 (367) w/manifold, 316 cfm, \$2,645; NVE model Mec 5000P CW, 195 cfm, \$1,395. Also available mounting frame for Mec 5000, \$250. Couplings and right angle drives also available. Call 1-800-362-0240. (P2)

460 Challenger pump, approx. 7 years old, clockwise rotation. \$1,000 OBO. Day 810-560-3268; Evening 734-878-5228. (PBM)

Complete line of Moro, Conde and engine-driven, stand-alone pump systems, DC10 washdown pump. Call us for any of your vacuum truck parts from shut-off valves, primary and secondary valves, hoses, vacuum pumps and drive systems. Septic Services Inc. 800-536-5564. (CPBM)

New **Masport** pumps and genuine **Masport** components. Compare our price before you buy. W-K Machine & Supply Co. Call 1-800-633-8947. Distributor. (PBM)

Vacuum Pumps - New, used, or rebuilt. 30 to 900 cfm. All major brands; air, water, or fan cooled. Rebuild specialists - rebuilt PB, M3, M10, and others available. 800-545-0174. www.tanksandpumps.com. (PBM)

Need a vacuum pump for your portable pumper? Try our new 30 cfm, 12 volt system. Less noise, no fuel. Automatic oiling, cheaper than a gas engine. 800-545-0174. www.tanksandpumps.com. (PBM)

ROLL-OFF TRAILERS

1993 GalBreath Single Container AC2 roll-off trailer, traveling head. Running gear, brakes and tires at 70% or better. Just sandblasted and painted. \$25,950. KLM Companies 617-909-9044. (P2)

SAFETY EQUIPMENT

Large quantity of Tyvek, Saranex and CPF3 suits, slush boots. Rubber, leather and nitrile gloves. Fittings and tank entry equipment. Retail value over \$300,000. Sale price \$150,000 OBO. Will separate. 716-284-1260 or 716-510-2482. (CP4)

SEPTIC TRUCKS

1990 Ford Cargo Star 8000, diesel, 2500 gallon waste, 200 gallon fresh, good truck. Located in Wyoming \$12,000. Call 307-630-2717. (P3)

1996 Int. ME 530 motor, 8-speed trans., tandem, 20,000 ft., 46,000 rear, 3700 gal., bought new 1998, one owner, well maintained w/paperwork, 244,000 miles, in-frame engine rebuild 241,000, H20W Masport, extra H15W w/rebuild kit, 2 Rigid snake machines. \$55,000 firm. Selling due to health. Pictures, info. 540-987-9468 Mike. (P4)

2005 Int. 7600, auto trans., 4000 gal. dump body, Wittig RFW150 DUR pump, steerable lift axle, Alcoa alum. wheels, 18,000 front, 20,000 rear, 60,000 miles, heated valves. Very nice truck. \$124,900 OBO. 513-260-7211, 513-738-3902. (P2)

1977 International 4300, 290 Cummins, 3000/100, 260 Jurop vacuum/pressure pump, tires 75%. \$12,500. 208-879-2800 Idaho. (P3)

1993 Mack CH613 350HP, Mack engine with 40K air ride rear with 14K ft. axle. 3,200 gallon Marsh vacuum tank with Masport 350 CFM liquid-cooled vac pump. Ready for work. \$29,500. 617-909-9044, KLM Companies. (P2)

FOR SALE: SEPTIC OR POTTY PUMPING TRUCK: 1991 Kodiak, 3116 Cat, Allison auto., A/C, AM/FM/CD, air seat, air brakes, single axle w/pusher, 2250 gal. waste, 150 gal. fresh, twin cylinder hoist, Moro M10 pump, 3" inlet, 4' dump, 24" manway on back, aluminum 2-potty detachable rack. Runs and looks good. \$20,000. Call Randy 660-947-7765 or 660-216-2051. North Missouri. (P2)

2004 Peterbilt Model 330, CAT motor, air ride susp., fully loaded, 3600 gal. Transway tank. Truck is like new, 50K miles, red. Asking \$82,000. 978-692-3085. (PBM)

1999 Vactor 2115, 1999 International, 15CF debris body, Roots PD vac. blower, 8' hydraulic boom w/joystick, hydraulic rotating hose reel, 600'x1" sewer jet hose, 80 gpm @ 2000 psi water jet system. Call for full specs and details. 305-251-8104. (P4)

Are you looking for a good used pump truck from 500 to 4000 gallons ranging from \$5,000 to \$37,000? Call Jerry at 918-381-9072. (P3)

SEPTIC TRUCKS

1994 Kenworth W900, 4500 gal., 425 Cat, 10-spd., 460 pump with 4500 gal. quad axle pup, \$65,000. 1999 FL-80, 3300 gal., 285 hp Cummins, 360 pump, \$45,000. Both daily drivers and good condition. Dan 269-420-1939. (P2)

1990 International, 2500 gal., good runner, A/C, Moro pump, 70 gal. fresh water, clean truck, single axle. \$19,000 OBO. Located in AZ. 928-667-0021. (PTI3)

1997 Peterbilt Model 357, CAT 3306 motor, Fuller 8-speed trans., 4200 gal. Transway tank, 800 Transway pump, 220K miles, red. Excellent condition, ready to work. \$55,000. 978-692-3085. (PBM)

1994 Ford LTLA 9000, 52 GVW tandem, Detroit diesel 350 hp, locking differential, engine brake. 2600 gallon tank and 400 cfm liquid cooled pump both 2 years old. New clutch. \$37,500. Colorado 719-748-3721. (P2)

1990 Ford F-800 Gray Water pump truck: Diesel, 5-speed, 48,000 miles, 1650 gal. poly tank mounted on a 15' flatbed, newer gas driven trash style pump, hoses, new clutch, excellent cond., and newer paint. \$11,000 firm. 541-923-0411. (P2)

1994 Freightliner, 3176 Cat engine, 10-speed, 260 Jurop vacuum pump, two-year-old 3,500 gallon tank, heated valves, \$42,000 OBO. Call for pictures. 920-743-8801. (P2)

2001 Intl. DT-466, 7-spd. tandem, new 3600 gal. tank, Masport 350 cfm vacuum pump, 237,000 miles, \$49,000. 2000 Intl., DT-466, auto., new 2300 gal. tank, 350 cfm Masport pump, 147,000 miles, \$44,000. Other new & used toilet & septic trucks available. Everything we sell has warranty. Lane's Vacuum Tank Inc. 1-800-592-3308. (PBM)

2007 Peterbilt 340 with a new Presvac 3600 gallon (US) aluminum vacuum tank unit. (4) 2008 Models Coming Soon. (Stock #13297A). **www.VacuumSalesInc.com, (888) VAC-UNIT (822-8648).** (PBM)

1985 International, 400 Cummins, 145,000 on inframe, trans. rebuilt, new PTO and Wally pump done by Intl. dealer, 3400 gal., A/C, 70% rubber, good runner. \$22,000. In AZ. 928-667-0021. (PTI3)

BUY IT - SELL IT - PLACE IT - www.pumper.com - AVAILABLE ANYTIME, ANYWHERE, ANY DAY

SEPTIC TRUCKS

1988 Ford Pumper, LN900, new engine, 3500 gallons. Call 610-767-5202. (P2)

FOR SALE: SEPTIC PUMPING TRUCK: 1995 Ford L9000, twin screw w/diff. lock and hi/lo rearend, 60 series Detroit, Allison auto., air brakes, 3400 gal. w/twin cylinder hoist, 3-month-old Moro M10 (235 cfm) reversible, hydraulic driven pump, 4" inlet, 6" outlet w/6" to 4" adapter, 24" manway on back, 24" manway on top. Unit in very good condition. Used every day. \$34,000 OBO. Call Randy 660-947-7765 or 660-216-2051. North Missouri. (P2)

1988 Ford LTL 9000 w/3500 gal. hyd. dump/door vacuum tank, Cat 400 hp engine, Fuller trans., air ride susp. Ready for work. \$28,900. 617-909-9044, KLM Companies. (P2)

1994 FL 70 Freightliner, 1620 gal. full door dump, new Masport water cooled pump, new tires, new brakes, 6" air dump, 125-gal. wash-down tank. Excellent condition. One owner. 605-286-3359. (P3)

2001 Ford F-750, 2,000 gal. steel tank, 3" intake valves, 6" discharge, newer Battioni pump. Needs engine rebuilt & clutch. 7.3 Intl. powerstroke. \$12,000 OBO. 231-679-1234 Mich. (P2)

Pre-owned Coleman tank (tank only), 3,500 gallon, c/s vacuum pressure tank. (Stock #VS102V) **www.VacuumSalesInc.com, (888) VAC-UNIT (822-8648).** (PBM)

1998 Ford with a Cusco 5,000 gallon c/s vacuum tank. (Stock #7300C) **www.VacuumSalesInc.com, (888) VAC-UNIT (822-8648).** (PBM)

1984 International S2300 vacuum pump truck, 2600 gallon tank with Moro M10 pump. Good starter or backup truck. \$19,500 OBO. 229-834-4775. (P4)

Pre-owned Presvac tank (tank only), 3,500 gallon, c/s vacuum-pressure tank. (Stock #VSIT01V) **www.VacuumSalesInc.com, (888) VAC-UNIT (822-8648).** (PBM)

2007 new Acro trailer, new Acro 7,000 US gallon aluminum vacuum pressure tank. (Stock #13273 A&B) **www.VacuumSalesInc.com, (888) VAC-UNIT (822-8648).** (PBM)

SEPTIC TRUCKS

2006 Sterling Acterra, Mercedes-Benz powered, has 22,000 miles. Direct drive pump R260. Price: \$56,420. 850-682-4021. (P2)

1985 Ford F-8000 pump truck, 2500 gallon, Battioni pump, 3208 CAT engine, Eaton transmission. \$12,000. 386-566-2277. (P3)

Need a tank and truck, any size, any make truck? Let us help you get the best deal. Custom built to your specs. For information and a price quote call 800-545-0174. **www.tanksandpumps.com.** (PBM)

SHOWER TRAILER

Showers Trailer - Gold Series: 32', new and used. Men and women sides each have 3 private shower stalls with changing area, 1 restroom stall, 1 sink. CCI/Brian Touey 805-896-3777. (PBM)

SLUDGE APPLICATORS

Agco Terra Model #2004 Gator sludge applicator. Rebuilt engine this year. Has injectors in rear located in Ohio. Call 412-403-4027. (P2)

1987 I.M.E. Super/Jector 3500 gal. vac/pressure tank, 250 hrs. on 3208 Cat re-man. motor. Pearson PB8 vac pump, four-knife shank, tires 66x43.00/25 at about 60%. Unit in good condition. \$38,500 OBO. Day: 810-560-3268; Evening: 734-878-5228. (PBM)

TANKS

2004 Pik-Rite 3,550 gallon tank. Make offer; must sell. 610-381-3114. (P2)

Vacuum tanks, 100 to 6000 gallons. All options available; hatches, primary, secondary, valves, catwalks, ladders, etc. Every-thing needed to build your own septic truck. Choose mild, stainless, or galvanized steel. Ask about full open doors. 800-545-0174. **www.tanksandpumps.com.** (PBM)

New 2500 gallon tank, 66" x 14", 36" manway bottom, 20" manway top, primary, 3" intake, 4" dump, hose trays w/hose racks, epoxy primered. Ready to set on your truck. \$8,000. New 3500 gallon tank, never used, 36" manway bottom, 20" manway top, 3" intake, 4" dump, epoxy primered. \$10,000. Delivery available. Other tanks available. 800-721-2774. (P2)

TANK TRAILER

New Presvac 5,500 gallon, C/S, DOT, vacuum tank trailer. (Stock #13325) **www.VacuumSalesInc.com, (888) VAC-UNIT (822-8648).** (PBM)

2007 new Acro trailer, new Acro 7,000 US gallon aluminum vacuum pressure tank. (Stock #13273A&B) **www.VacuumSalesInc.com, (888) VAC-UNIT (822-8648).** (PBM)

TOOLS

T&T Tools: Probes, Hooks. Probes feature steel shafts with threaded and hardened tips. The insulated **Mighty Probe™** tested to 50,000 volts. **Top Poppers™** open manhole covers easily. Free catalog. **www.TandTools.com.** Phone **800-521-6893.** (CPBM)

Crust Busters - Portable, lightweight machine guaranteed to mix up septic tanks and grease traps! Save time and money! **www.crustbusters.com,** 1-888-878-2296. (PBM)

TOYS

Septic pumper and vacuum die-cast toy trucks in your choice of colors and logos. Several cabs available. Call 877-450-2100 or write to Granite State Collectibles, PO Box 440, New Ipswich, NH 03071. (PBM)

TRAILERS VACUUM/TANKER

1993 Presvac 5,800 gallon steel vacuum tank trailer. Asking \$17,500. 1997 Mack pumper, 3800 gal. steel tank, 450,000 miles. Asking \$44,000. Call 1-716-432-2885. (P2)

TRUCKS\BOOM

1986 GMC C7 with Cook & Ingle septic tank set bed, runs and works, looks great. \$5,800. Call John 931-526-2964 or 931-261-2331. (P2)

TRUCKS\DELIVERY

1985 Mack DM600, 6-spd, cab replaced, 4000 gallon tank, 3 valves, Moro A-C4 pump, 1-15,000 lb. Bethlehem Mfg. mountrail bed, 18' bed, 10' boom, double post on back. 252-491-2321. (P6)

TV INSPECTION

Pipeline Inspection Push Cam. EC-15LCD EELCAM ELITE (3 yrs. old), portable and compact color system complete with approx. 200' of 1/2" gel rod push cable, in-line sonde, color 15" LCD monitor #040405S, VCR, on screen counter with keyboard, reel brake, microphone, camera test port, (2) centering sleeves, heavy duty fold-up brief case style case for easy transport, \$5,500. Also EC-15LCD-DVD (1-1/2 yrs. old). Same as above except uses DVD instead of VCR. \$6,700. 813-323-7492. (CP2)

2001 Aries Saturn 3 Pipeline Video Inspection System mounted in an enclosed trailer. VC-3000 video capture system, TR-2000 camera transporter 6' to 30", 1200' reel/winch with level wind, PE-1111 pan & tilt camera with aux. lights. Misc. skids, poles, tiger tales, emergency repair kit. Unit is ready for work. PRICED TO SELL \$9,999. 715-967-2838 or 1-866-203-2033. (P5)

Rovver 5.0 "Steerable" Tractor System. Straight View for 4" lines and a pan & tilt for 6" and above. Grease wheels, aux. lights. The system is in a Demo box that has wheels and attaches to a 2" receiver hitch. \$20,000 OBO. Call Scott for pictures and web site link @ 703-843-3350. (CP3)

2003 P-448 PEARPOINT STEERABLE TRACTOR with power scissor lift, 18" to 72" pipe, S/N 448-063. Complete w/accessories. \$25,000 OBO. Dale or Mark 269-381-2400. (CMPBM)

1998 Cues TV grout unit, 34,880 miles, color camera, diesel, generator. 972-938-1905. **www.empireequip.com.** (CPBM)

Aries TV sewer inspection system, pan & tilt, on tracks, color, in 1993 Ford E350 box van, roof air, 7.3 diesel, 80K miles, Martin diesel generator 7.5 kw, TV, VCR, 3 units available. Call or email for more info and pictures. We can ship to any location. Very nice City owned trucks. Asking \$29,950 ea. Call 573-374-8785 or email **elitemotors@charter.net.** (CP4)

VACUUM LOADERS

1982 Ford Vactor unit, wet-dry, 1976 Hend. V6 Detroit, V4 Detroit, vacuum truck; 1970 Hend. V6 Detroit, V4 Detroit, vacuum truck. All in working condition. 806-273-2865. (P3C4)

VACUUM LOADERS

2003 Guzzler/Sterling chassis. 147,000 chassis miles, 335/1250 CAT C-10, 10 speed Eaton, 27" Hibon 285. 64K GVW. Good shape. 414-349-3225. (P4)

2007 Sterling LT9500 tri-axle with a new Presvac, Powervac 3800, 3,250 gallon US, DOT, wet/dry industrial, vacuum tank loader. *In Production.* (Stock #13294B) **www.VacuumSalesInc.com, (888) VAC-UNIT (822-8648).** (PBM)

1993 International Vactor unit, with 4500 cfm rebuilt blower, low hours. Ideal for dry vacuum work, manual 8" 180-degree swing boom. \$40,000 OBO. Call 765-474-1916 for details. (P2)

VANES

American Industrial Components: Our vanes are manufactured from the highest quality laminated materials available and are fabricated to exact tolerances and specifications. Please see our ad in this issue. 800-272-7557. (PBM)

Dura Comp 535, high-quality non asbestos vacuum pump vanes. Good to 400°F. Buy factory direct and save. Same day shipment on most models. Juroop, Battioni, Moro, Masport, Fruitland, Demag. Long lasting Dura-Comp 535 pump vanes carry a "Money-back" guarantee. Call us today. Powerflo Products 800-758-4788 or 562-997-0720. (PBM)

WANTED

WANTED: 2505 Terra Gator Tool Bar, 4 or 5 shank, straight bar, model P-16 Case IH reset style. Ph: Ron @ 204-745-8310. (CPT4)

Looking for 1-1/4" USED 2500 psi sewer cleaning hose, any length. Call 800-235-9704 or 719-541-2967 or email: **canamgeothermal@fairpoint.net.** (P3)

Water jetting equipment. We rent, sell and repair water blasters. Visit us at: **www.waterjettingequipment.com** or phone 714-259-7700. (CPBM)

WATERBLASTING

Wanted to Buy: Vactor 2100s and late model Guzzlers. Cash. Phone 800-336-4369. (CPBM)

PLACE YOUR AD ONLINE AT **www.pumper.com** - IT'S ALWAYS THERE TO MEET YOUR BUSY SCHEDULE

WATERBLASTING

NLB 10-250 2000 model year with 1,200 hrs., 250 hp @ 43 gpm. Complete mounted on 1993 International truck with 120,000 miles. Fluid/power end. Just completely serviced. In good shape. \$49,750. KLM Companies, 617-909-9044. (P2)

WATERBLASTING

2002 NLB 1020 skid mounted waterblaster, 16 gpm @ 10K with 700 original hours. Excellent condition. \$25,000. KLM Companies, 617-909-9044. (P2)

WATERBLASTING

1987 NLB 20250, 1989 NLB 20250, 1996 NLB 15600, 1995 NLB 10200, 1987 NLB 10150. Call for pricing and pictures 330-270-9900 ext. 3. (P3C4)

WATERBLASTING

2003 NLB 10-150 electric waterblaster, (0) hours on unit - never used. Marathon Motor on skid. If you want brand new this is it. Priced to sell @ \$37,500. KLM Companies, 617-909-9044. (P2)

WATERBLASTING

Flexible lancing machine, Freelance MK5 Model #07-95, serial #FL5-1016. Call for information. 330-270-9900 ext. 3. (P3C4)

**Cleaner****Pumper
Pumper Trader****CLASSIFIED AD FORM****PRO****ON-SITE
installer**

Please print ad legibly below with *correct punctuation* and *phone number*. Circle each word to be bolded, if any. (\$1.00 extra per word)

CHOOSE THE CATEGORY:

- | | | | | | |
|--|---|---|--|---|---|
| <input type="checkbox"/> Aerators | <input type="checkbox"/> Dredges | <input type="checkbox"/> Levels & Transits | <input type="checkbox"/> Positions Wanted | <input type="checkbox"/> Root Control | <input type="checkbox"/> Trailers- Vacuum/Tanker |
| <input type="checkbox"/> Blowers | <input type="checkbox"/> Excavating Attachments | <input type="checkbox"/> Locators | <input type="checkbox"/> Pressure Washers | <input type="checkbox"/> Safety Equipment | <input type="checkbox"/> Trucks (dump/septic/misc.) |
| <input type="checkbox"/> Bucket Machines | <input type="checkbox"/> Excavating Equipment | <input type="checkbox"/> Miscellaneous | <input type="checkbox"/> Pumps-Dredge | <input type="checkbox"/> Septic System Components | <input type="checkbox"/> TV Inspection |
| <input type="checkbox"/> Businesses | <input type="checkbox"/> Hand Tools | <input type="checkbox"/> Parts & Components | <input type="checkbox"/> Pumps-High Pressure | <input type="checkbox"/> Septic Tanks | <input type="checkbox"/> Vacuum Loaders |
| <input type="checkbox"/> Business Opportunities | <input type="checkbox"/> Hazardous Waste Units | <input type="checkbox"/> Pipeline Rehabilitation | <input type="checkbox"/> Pumps-Submersible | <input type="checkbox"/> Septic Trucks | <input type="checkbox"/> Vanes |
| <input type="checkbox"/> Cable Machines | <input type="checkbox"/> Hydroexcavation | <input type="checkbox"/> Portable Restrooms | <input type="checkbox"/> Pumps-Vacuum | <input type="checkbox"/> Service/Repair | <input type="checkbox"/> Vehicle Tracking |
| <input type="checkbox"/> Computer Software | <input type="checkbox"/> Jetters-Trailer | <input type="checkbox"/> Portable Restroom Tanks | <input type="checkbox"/> Pumps - Washdown | <input type="checkbox"/> Slide-In Units | <input type="checkbox"/> Wanted |
| <input type="checkbox"/> Dewatering | <input type="checkbox"/> Jetters-Truck | <input type="checkbox"/> Portable Restroom Trailers | <input type="checkbox"/> Pumps-Water | <input type="checkbox"/> Sludge Applicators | <input type="checkbox"/> Wastewater Transfer |
| <input type="checkbox"/> Drainfield Restoration | <input type="checkbox"/> Jet Vacs | <input type="checkbox"/> Portable Restroom Trucks | <input type="checkbox"/> Rodding Machines | <input type="checkbox"/> Tanks | <input type="checkbox"/> Waterblasting |
| <input type="checkbox"/> Drain/Sewer Cleaning Equip. | <input type="checkbox"/> Lease Financing | <input type="checkbox"/> Positions Available | <input type="checkbox"/> Roll-Off Containers | <input type="checkbox"/> Tools | |

CHOOSE THE PUBLICATION(S): (Deadlines are for the month preceding issue)

- | | | |
|---|---|--|
| <input type="checkbox"/> CLEANER
Deadline: 1st of the Month | <input type="checkbox"/> PUMPER/PUMPER TRADER
Deadline: 10th of the Month | <input type="checkbox"/> PRO
Deadline: 17th of the Month |
| <input type="checkbox"/> MUNICIPAL SEWER & WATER
Deadline: 1st of the Month | <input type="checkbox"/> ONSITE INSTALLER
Deadline: 17th of the Month | |

CLASSIFIED AD RATE:

\$1.00 per word, per month, with a 20-word minimum or \$20.
[\$1.00 extra per bold word (key words only)]

ADVANCE PAYMENT REQUIRED:

No billing for classified ads. Payment must be received in advance before publishing.

CALCULATE THE AMOUNT DUE:

_____ words X \$1.00 = _____ X _____ Publications X _____ Months = \$ _____
(\$20 minimum) # of publications checked above # of months to run the ad Total Amount Due

(Example: 25-wd. ad x \$1.00 per word = \$25.00;
\$25.00 x 2 publications [Pumper & Pro] = \$50.00;
\$50.00 x 2 months to run the ad = \$100.00 Total)

FILL IN COMPANY AND PAYMENT INFO:

COMPANY NAME: _____
 ADDRESS: _____ PHONE: _____
 CITY: _____ STATE: _____ ZIP: _____

MAIL this completed form with payment to:
 COLE Publishing Inc., PO Box 220, Three Lakes, WI 54562

FAX this completed form to: **715-546-3786**

ONLINE forms at: www.cleaner.com
www.pumper.com
www.promonthly.com
www.onsiteinstaller.com
www.mswmag.com

QUESTIONS: CALL 1-800-257-7222

PLEASE FILL OUT CREDIT CARD INFORMATION COMPLETELY INCLUDING V-CODE (3-DIGIT NUMBER FOUND BY YOUR SIGNATURE)

CREDIT CARD NO.: _____ V-CODE: _____ EXP. DATE: _____
 CARDHOLDER NAME: _____ PHONE: _____

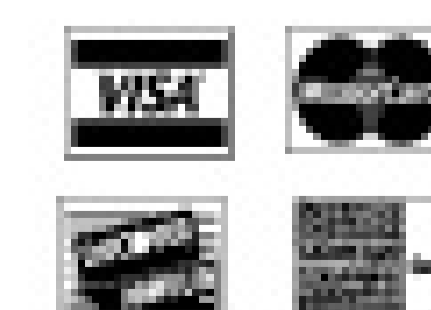
WE ACCEPT:

**EXCLUSIVE INVITE
FOR PUMPER &
CLEANER EXPO ATTENDEES**



In life, as in sewage, the best rises to the top.

KENNY



**“THOROUGHLY ENJOYABLE, WARM-HEARTED
and GENUINELY HILARIOUS . . . the Jacobson brothers are
clearly a talent to watch.”** —Matthew Turner, *View London*

**“It’s SO MUCH MORE ENJOYABLE
THAN *BORAT* and equally funny.”**
—Palm Springs International Film Festival

**“Funnier than *KNOCKED UP*
and *SUPERBAD*”**
—Stuart O’Connor, *Screenjabber.com*

“TOTAL HILARITY”
—IC Network-Wales

★ ★ ★ ★ ★
—Leigh Paatsch, *Herald Sun*

**One of the FUNNIEST, WARMEST FILMS
OF THE YEAR. Highly recommended.”**
—Nigel Kendall, *London Times*

A JACOBSON BROTHERS FILM

XENON PICTURES, INC., THUNDERBOX FILMS and MADMAN CINEMA in association with SPLASHDOWN present a JACOBSON BROTHERS FILM “KENNY” starring SHANE JACOBSON EVE VON ERBIA RONALD JACOBSON IAN DRYDEN CHRIS DAVIS JESSE JACOBSON
PRODUCED BY CLAYTON JACOBSON AND ROHAN TIMLOCK MUSIC BY RICHARD PLEASANCE SOUND DESIGN BY CRAIG CARTER EDITED BY CLAYTON JACOBSON AND SEAN LANDER WRITTEN AND CO-PRODUCED BY SHANE JACOBSON WRITTEN AND DIRECTED BY CLAYTON JACOBSON



WWW.KENNYTHEMOVIE.COM



WWW.XENONPICTURES.COM



Pumper

Xenon Pictures and Pumper invite the attendees of the Expo to the US Premiere of

KENNY

Friday, February 29th at 7:30 pm

BAXTER AVENUE THEATRES • 1250 Bardstown Road (behind Mid City Mall on Baxter Avenue) • Louisville, KY

Simply RSVP to kennyrsvp@gmail.com with your first and last names along with how many guests you will be bringing. Seating will be on a first come, first served basis.

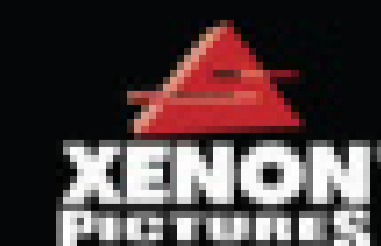

WATER JETS FOR RENT



- Units from 4,000 to 40,000 psi, including convertibles
- 60-600 hp, diesel or electric
- Rent, buy or lease
- Branches in MI, TX, NJ, CA, LA

NLB Corp. 1-877-NLB-7996
www.nlbcorp.com

PADLOCKS

- Your Padlocks
- Your Key Number
- Any Quantity
- Best Prices

Quick-Shipped Anywhere!



SERVING THE PORTABLE SANITATION INDUSTRY FOR 14 YEARS—WE'RE THE BETTER WAY TO BUY PADLOCKS™

Call For FREE CATALOG or Instant Quote!

LockMasters
1-800-461-0620

www.lockmastersusa.com

sales@lockmastersusa.com • Fax (850) 914-9754

Lease-Financing New & Used Leasing Unlimited

Serving Our Client's Needs Since 1987

1.800.992.1611

E-mail: leasing@mindspring.com
Web: www.leasing-unlimited.com



1-800-333-9274

www.Jettersonline.com

Pressure Washers

HONDA @ 2700PSI \$377
HONDA @ 3000PSI \$416
HONDA @ 4000PSI \$859



We Customize high pressure pumps

Honda Engines



5Hp GC **\$199**
6.5Hp GX **\$349**
8Hp GX **\$459**
9Hp GX **\$489**
18Hp GX **\$1,099**

BEST Sellers ALWAYS on Sale

5.6GPM @ 4000PSI **\$399**
8.0GPM @ 3500PSI **\$499**
7.0GPM @ 5000PSI **\$599**



Call For Free Quotation. We Also Stock Pumps With Left Hand Drive, Tapered Shaft, Car Wash Duty, 316 Stainless Steel and Unique Applications
1-800-964-9274

Water Cannon - 5 Offices Nationwide, Since 1981

Mobile Dewatering Service



Municipal & Industrial Sludge Digesters, Lagoons, Ponds, etc.

- Double Belt Filter Press
- Up to 25% Drier Cake
- Professionally Staffed
- US & Canada

Fluid Technology, Inc.

P.O. Box 937, Oxford, OH 45056
Phone: 513-981-7808
E-mail: sales@fluidtechinc.net
Web site: www.fluidtechinc.net

AERRATECH



Aerratech, LLC

- ❖ New and Used Terralifts ❖
- ❖ All Parts Available ❖

SHOW SPECIAL!
\$34,900

Come see us at



Booth 21000

Sales: 603 253 4774
Parts and Service: 888 298 4272



1.800.257.7222

Now Available In 4-Color

Marketplace advertising

Deadlines:

Pumper: 10th of the month*
*PRECEDING ISSUE DATE

Pumper

Pumper Marketplace gives you nationwide exposure to thousands of industry professionals. Layout and design is included FREE, and we can fax or e-mail you a proof for final approval!

Choose a size that works best for you!

Size A: \$309^{00*}

1.875" w x 4.875" h

This size is great for 2 photos!

Size B: \$209^{00*}

1.875" w x 3.2" h

Perfect size for one photo!

Size C: \$109^{00*}

1.875" w x 1.5" h

A great value!

*Black and white prices, call for 4-color pricing.

[Send ad materials and payment to: COLE PUBLISHING INC. • P.O. BOX 220 • THREE LAKES, WI 54562]

SEPTIC SEEP

RESTORING DRAINFIELDS FOR OVER 50 YEARS!



Over 90% of septic systems fail due to problems in the drain field.

THIS MONTH ONLY: MENTION THIS AD AND GET A CASE (4 GALLONS) FOR ONLY \$123.50!



Visa & MasterCard Accepted

1-800-537-5800

Kwikk-Lokk

Vacuum Truck
Couplers and Hose.

www.kwikk-lokk.com
(814) 899-3644

CONFINED SPACE ENTRY EQUIPMENT PACKAGE ONLY \$ 3,295

The best package on the
market includes:

- 4-Gas Air Monitor
(With 3 Year Sensor Warranty)
- 7' Tripod
- 3-Way Fall Protection
- Work Winch
- Full Body Harness



Add a Blower with 15' of duct for only \$ 300!

Other Equipment Available

- Sewer Maintenance Tools
- Magnetic Lid Lifters
- Camera Systems
- Smoke & Dye Testing Items
- Blowers / Ventilators
- Vacuum Pumps and Acc.
- Aluminum Folding Ladders
- PPE
- High Pressure Water Jetters

MTECH 800.362.0240

www.mtechcompany.com

UDOR USA World Leader in Industrial Jetting Pumps

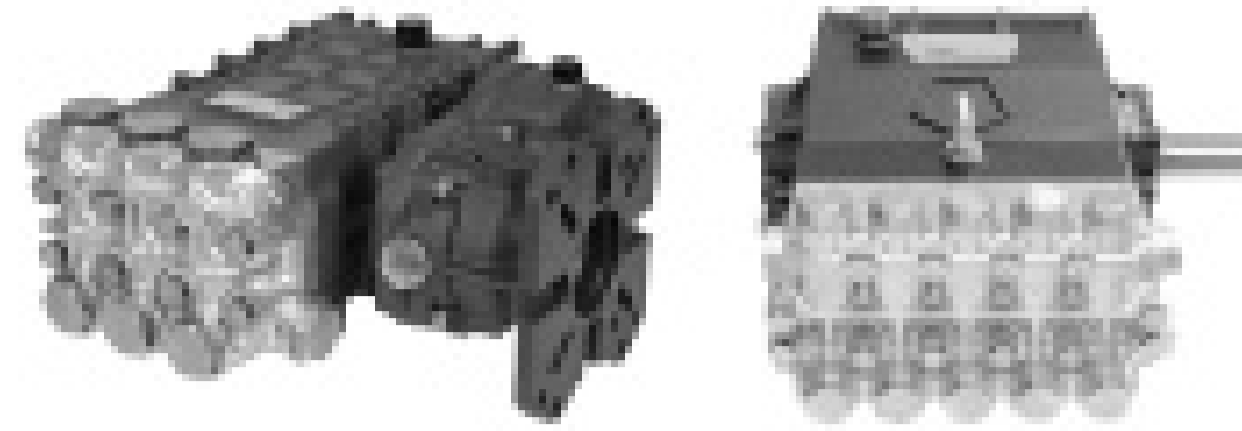

- | | |
|--|--|
| GKC Series Industrial
Jetting Pumps
• 4.5 to 11.5 GPM
• Up to 5,000 PSI | Penta Series Industrial
5-Cylinder Jetting Pump
• 6.5 to 18 GPM
• Up to 6,000 PSI |
|--|--|

Drive Options:

- Gas Engine Drive
- Electric Motor Drive
- PTO Shaft Drive
- Hydraulic Drive
- Gear Reduction



UDOR USA

500 Apollo Drive Lino Lakes, MN 55014
Tel: 651-785-0666 Fax: 1-800-732-2670
www.udorusa.com • info@udorusa.com

STOP!

DON'T ORDER ANY MORE BIOPRODUCTS
UNTIL YOU FIND OUT ABOUT BioOne®'s
REVOLUTIONARY TECHNOLOGY.

Drain Line, Grease Trap, Septic System Maintenance.

Profitable, Easy to Sell, Simple to Use.

There's nothing else like it.

Professional strength, EPA-recognized BioOne®.



CALL FOR A FREE SAMPLE

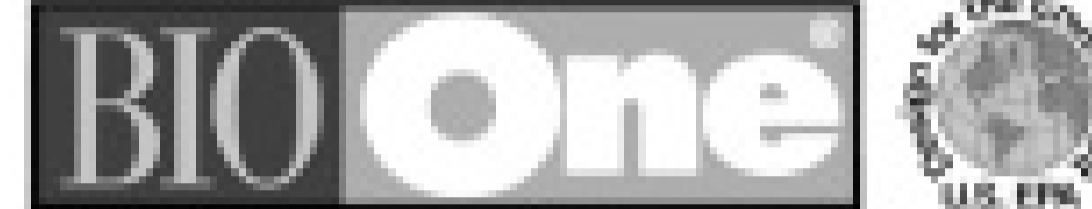

800-951-4246

One Biotechnology • www.1biotechnology.com

Simple Solutions DISTRIBUTING LLC

We Stop The Stink Guaranteed!
Budget Conscious Solutions for
Wastewater Odor Control.

- ODOR ADSORBERS FOR: • Manhole Openings
• Lift Station Vents • Plumbing and Septic Vents
• Large Industrial Applications

Mention this Ad and Save 10%!! 20% on orders over \$2000!!

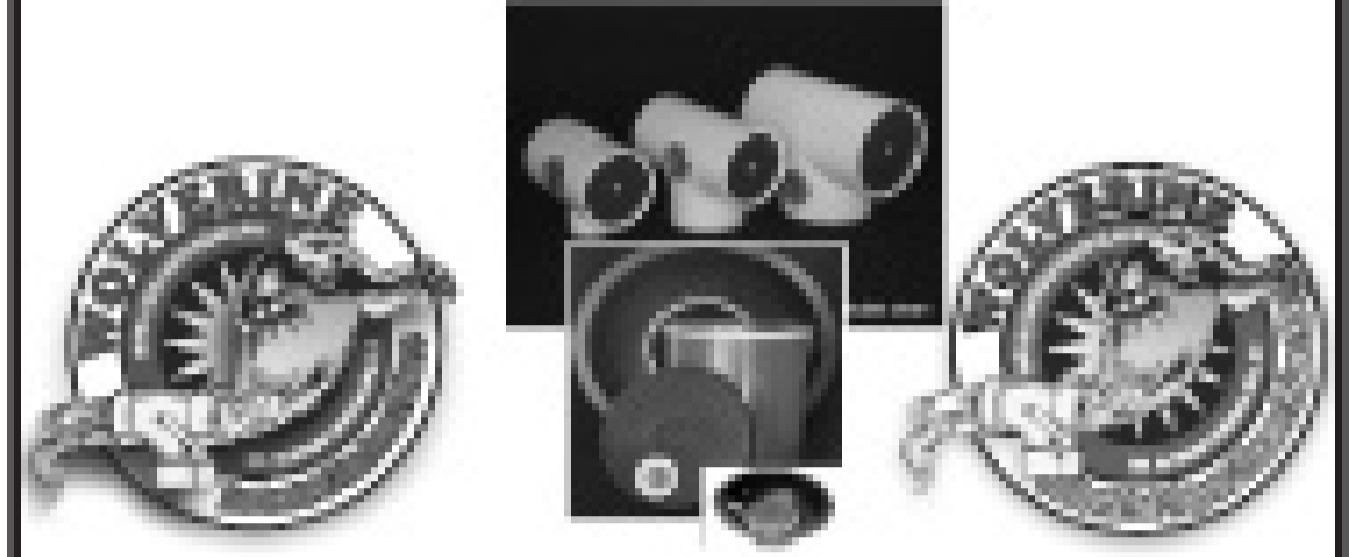

973-846-7817 or
866-667-8465

www.IndustrialOdorControl.com
www.StopSepticOdor.com Booth 49

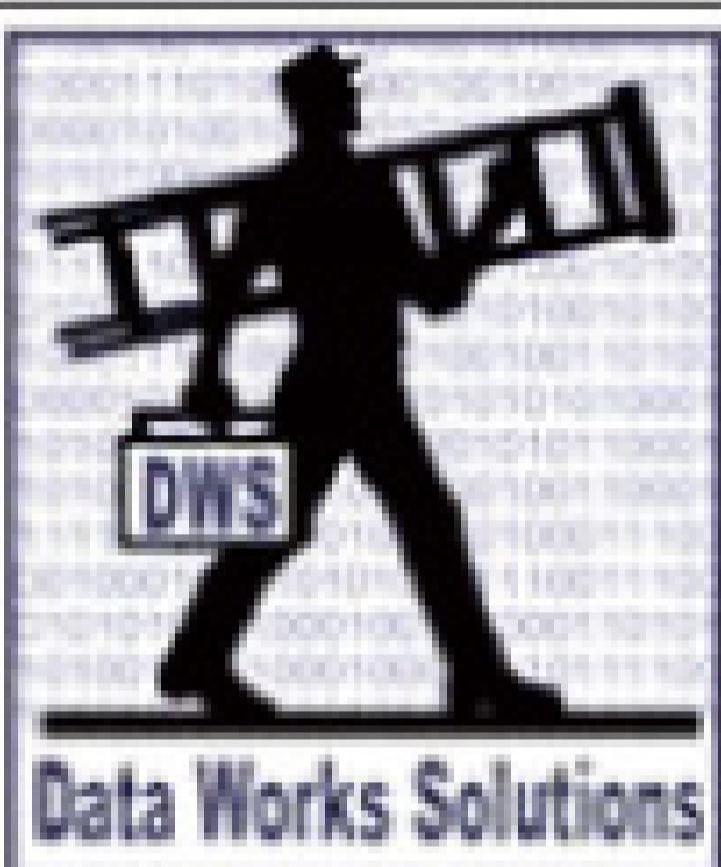

30 Day
Free
Trial



Data Works Solutions

Two Great Products!

DWS BackOffice

www.dwsbackoffice.com

Recurring Billing! Task Lists!
Routing Sheets! Much More...

DWS WebHosting

www.dwswebhosting.com

Sanitation Business Websites

info@dataworkssolutions.com

1-866-370-7979

Waterblaster Rentals

Houston, Texas



Boatman Industries

1K to 50K psi
60 hp to 1000 hp
Waterblasters & Accessories
Used Equipment Sales

713-641-6006
www.boatmanind.com



2002 International 4400

with 139,801 miles, VIN:
1HTMKAAN92H533662, with Abernathy
2,500 gallon septic pumper
unit S/N: 2500083100PNR102

CENTER CAPITAL CORPORATION®

A Subsidiary of Webster Bank, N.A., Member FDIC

Asking Price: \$37,500.00

Contact: Stephen Krzanowski

Phone: 860-409-2924

THE LEGENDARY SEPTI-MARKER



YOUR
COMPANY
INFORMATION
HERE!

CALL FOR
YOUR
QUOTE
TODAY!

HOW DOES IT WORK?

1. ORDER YOUR MARKERS
2. ASSEMBLE MARKERS (2 PCS)
3. LEAVE IN CUSTOMER'S YARD
4. MAKE MONEY!!

PLANT YOUR
BUSINESS CARD

WORKS AS A
BUSINESS CARD
AND TANK LOCATOR

ALSPA 1.800.537.5800



MAKE YOUR MOVE

February 27 -
March 1,
2008



Louisville 2008

More info at www.pumpershow.com or 1.800.257.7222

MAKE YOUR MOVE

DISCOUNT ALUMINUM

SHEET, COIL, PLATE

3003/5052/
5454/5083/5086
AND MORE

20 MILLION
POUND INVENTORY

ARE YOU PAYING
TOO MUCH?

1-888-540-0066
ASK FOR JAYSON

FAX:
440-286-2229

E-MAIL:
captaluminum@msn.com

T&T TOOLS T&T Tools
800-521-6893
800-521-3260 FAX

E-mail sales@tandttools.com • www.tandttools.com

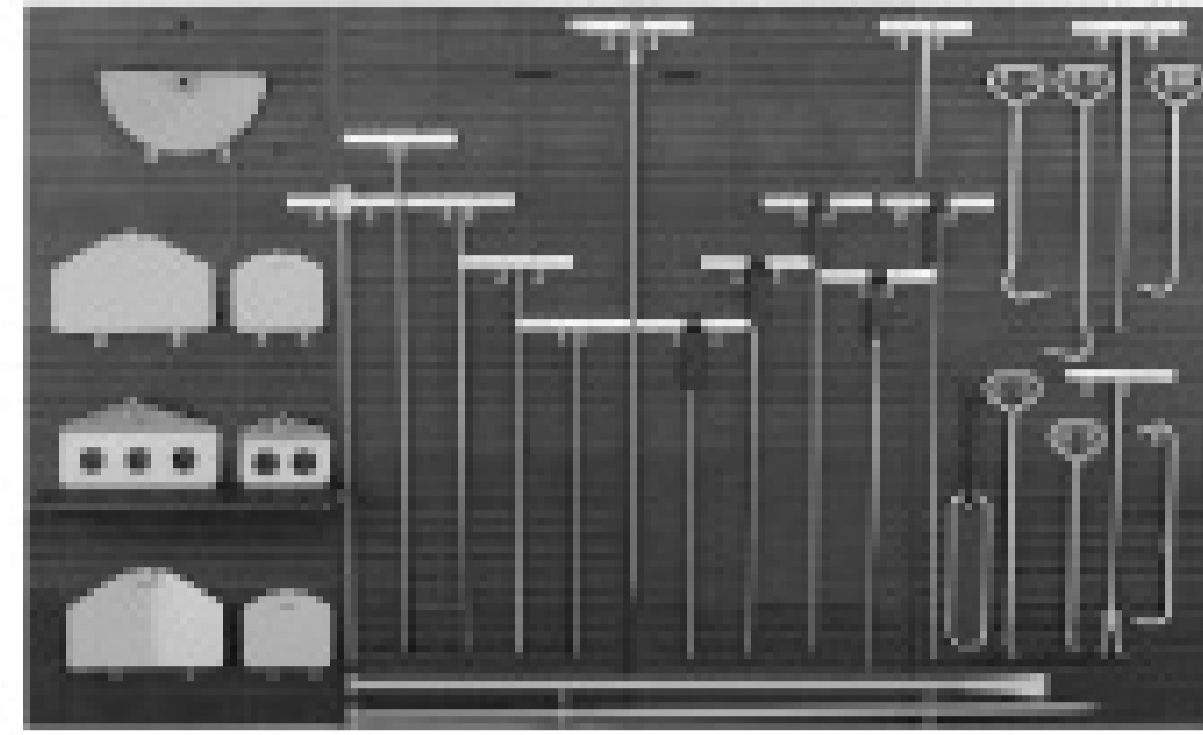

Mighty Probe™ Sludge Hoe™ (insulated) Sludge Spud™ Manhole Hook™ Tommy Hook™ Striking Head™
Handy Hook™ Water Probe™ Curved Spud™
Top Popper™ Ground Buster™ Smart Stick™ (standard)



Booth 3099

www.tandttools.com

ALUMINUM Vacuum Tanks

ALUMATANK

progress tank.com

PORTAVAC

Septic & Restroom Service

New Terralifts for sale!
\$29,900

We only have **three**, and we won't be at the show.

Tribill, Inc.
413 236 0935

"You're going to **WORK**, not **WAR!**"

ARE YOU STILL USING A HOOK OR PICK AXE TO REMOVE SEPTIC TANK COVERS?
NOW THERE IS A BETTER WAY!



Booth 18024

Call for a **FREE 30 Day Trial**

phone: 612.860.7047
fax: 866.271.9057
email: info@BigEasyLift.com
www.BigEasyLift.com



Eliminate back injuries with BigEasyLift



ASHLAND PolyTraps

Grease, Oil, Hair and Lint Traps and Interceptors

- NO Rust or Corrosion
- Lightweight
- Very Cost Effective
- Sizes up to 560 Gallons
- Made in the U.S.A.!

LIFETIME WARRANTY!
Certified by U.P.C., IAPMO and P.D.I.

800-541-8004

PolyTraps@Amplex.net



Booth 3011

90 DAY JETTER TRIAL

Plumbers - Let us improve your bottom line



13HP
4000 PSI
\$1,949

Free Freight

COMPLETE DETAILS AT
www.amazingmachinery.com

1-800-504-7435

DYE TRACERS

Solutions for:

- Infiltration
- Septic Systems
- Cross Connection
- Leaks and more...



BRIGHT DYES

Division of Kingsdale Chemicals

www.brightdyes.com • FAX: 937-886-9300



Booth 3055



FREE SAMPLE 1-800-394-0678

NEED GLOVES?



- 14" Gauntlet
- Plastic Coated
- Sandpaper Finish Grip
- Jersey Liner
- One Size Fits All

\$35 PER DOZEN \$189 FOR 6 DOZEN

TO ORDER, SEND A CHECK, MONEY ORDER OR CALL US TOLL FREE! Make checks payable to: ADVANCE GLOVE CO. Please include UPS shipping address

Major Credit Cards Accepted!
ADVANCE GLOVE CO.
PO BOX 149-LEHMAN, RI 02849
TOLL-FREE: 1-800-323-1223

SEPTIC ODOR PROBLEM?

ODORHOG™ Charcoal Activated Vent Pipe Filters Remove Sewer & Septic Odors from Plumbing Vents

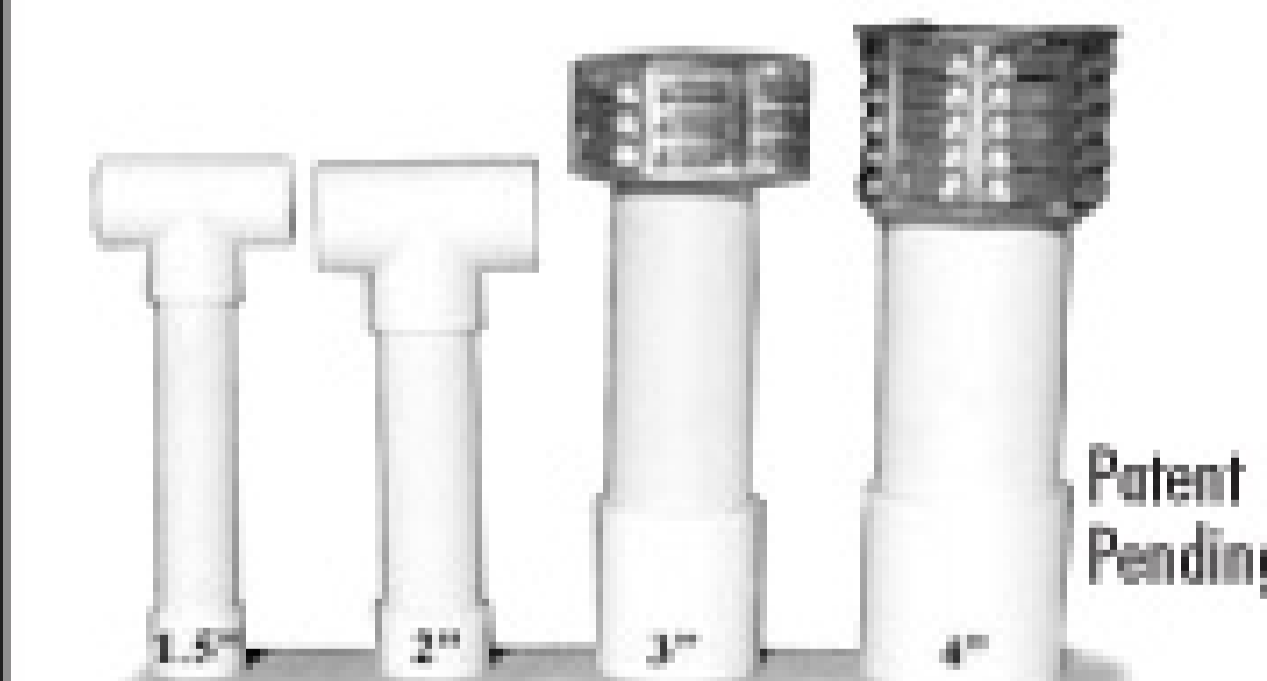

Patent Pending

ODORHOG™ Filters Come in 5 Standard Sizes or Any Custom Size You Specify
SAME DAY SHIPPING & PRIVATE LABELING AVAILABLE

A&M BIO-FILTER, LP
1.800.963.6746
www.odorhog.com

Call for our **FEBRUARY SPECIAL OFFER!**

WWW.ROOTERMAN.COM



Booth 9015 & 9115

Franchises available with low, flat fee
New concept. Call 1-800-700-8062.

FRANCHISE PACKAGE \$7,950.

EASILY MOVE RESTROOMS

- ✓ Aluminum Frame
- ✓ Ships UPS
- ✓ Carry ADA's
- ✓ Models starting at \$380



Booth 6059



Available with 2, 4, 6 or even 8 wheels and your choice of air or solid foam tires.

Super Mongo Mover®

DA
Deal Assoc. Inc.

www.dealassoc.com
866.599.3325



The Solution For All Of Your Aluminum Vacuum Tank Needs



**5 YEAR
WARRANTY
ON NEW TANKS**



#7198, 7199, 7201

IN STOCK

7000 Gallon aluminum trailer, full length fender/hose trays, 60,000# Watson Chalin air ride suspension, polished aluminum wheels
\$56,000 + FET

IN STOCK

3,800 Gallon aluminum tank on 2000 Freightliner chassis, with Jurop PNR 142 vacuum pump, \$64,900 tax included

Longhorn Tank Co.

P.O. Box 1147

Gravette, AR 72736

800-422-9840

479-787-7910

TRANS LEASE, INC.

Trans lease is committed to providing competitive leasing and financing while maintaining strong relationships through personal and flexible service. Trans Lease has been in business since 1991, and is ranked in the top 100 largest Leasing Companies in the U.S.

Our lease and finance programs are especially designed for your business. Trans lease gives you the power to expand and attain new and growing markets.

LEASE & FINANCE AVAILABLE/FLEXIBLE & EXTENDED TERMS

FAST APPROVALS ONLINE

GO TO WWW.TRANSLEASEINC.COM

FILL OUT OUR CREDIT APPLICATION W/ELECTRONIC SIGNATURE

**CALL FOR
QUOTE**

Call Randy or Cassie @ **877-600-6423**

4475 E. 74th Ave. #103 Commerce City, CO 80022 WWW.TRANSLEASEINC.COM

Look for us in
KeeVac
Industries, Inc.
BOOTH #9003



WANTED
FOR EXCESSIVE QUALITY!



Have you seen this trailer?



Call (800) 815-2557 or
visit jagmobilesolutions.com

REWARD!



Booth 7131

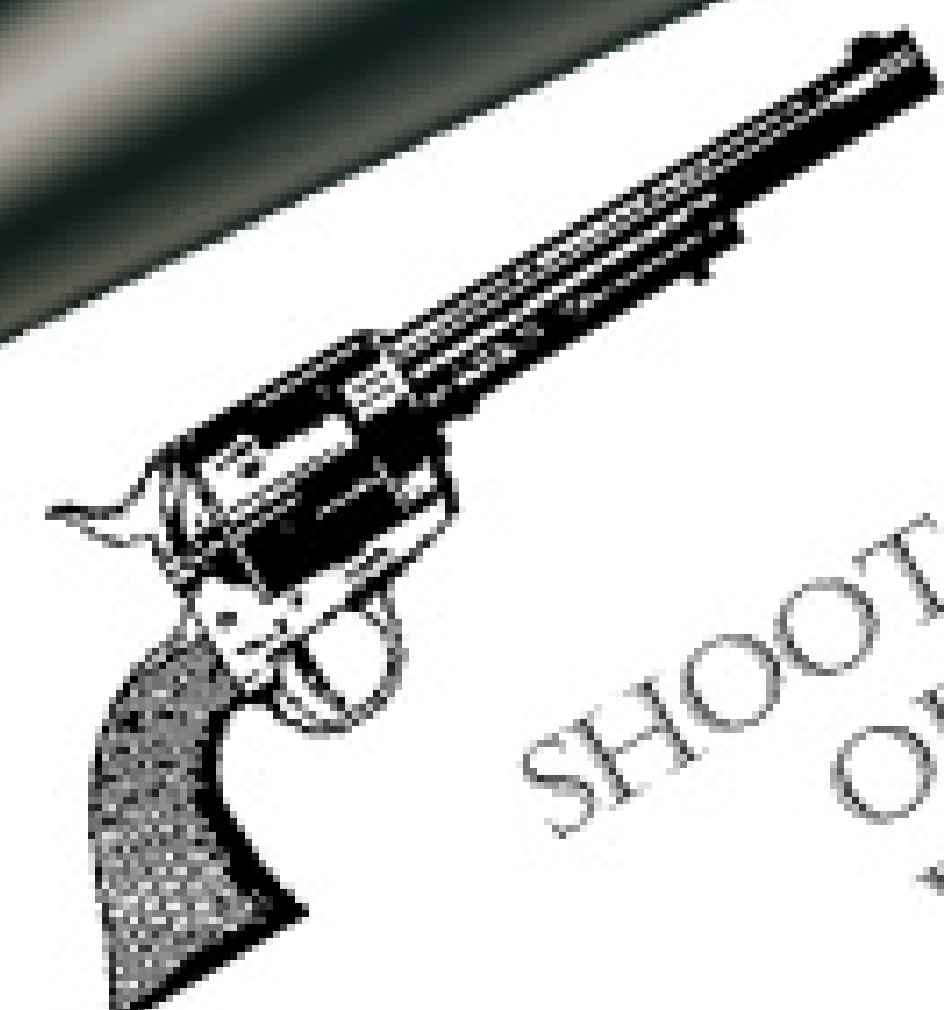

SHOOT OVER TO
OUR NEW
WEBSITE!

Pumper TRUCK STOP

see photos in COLOR at www.pumper.com

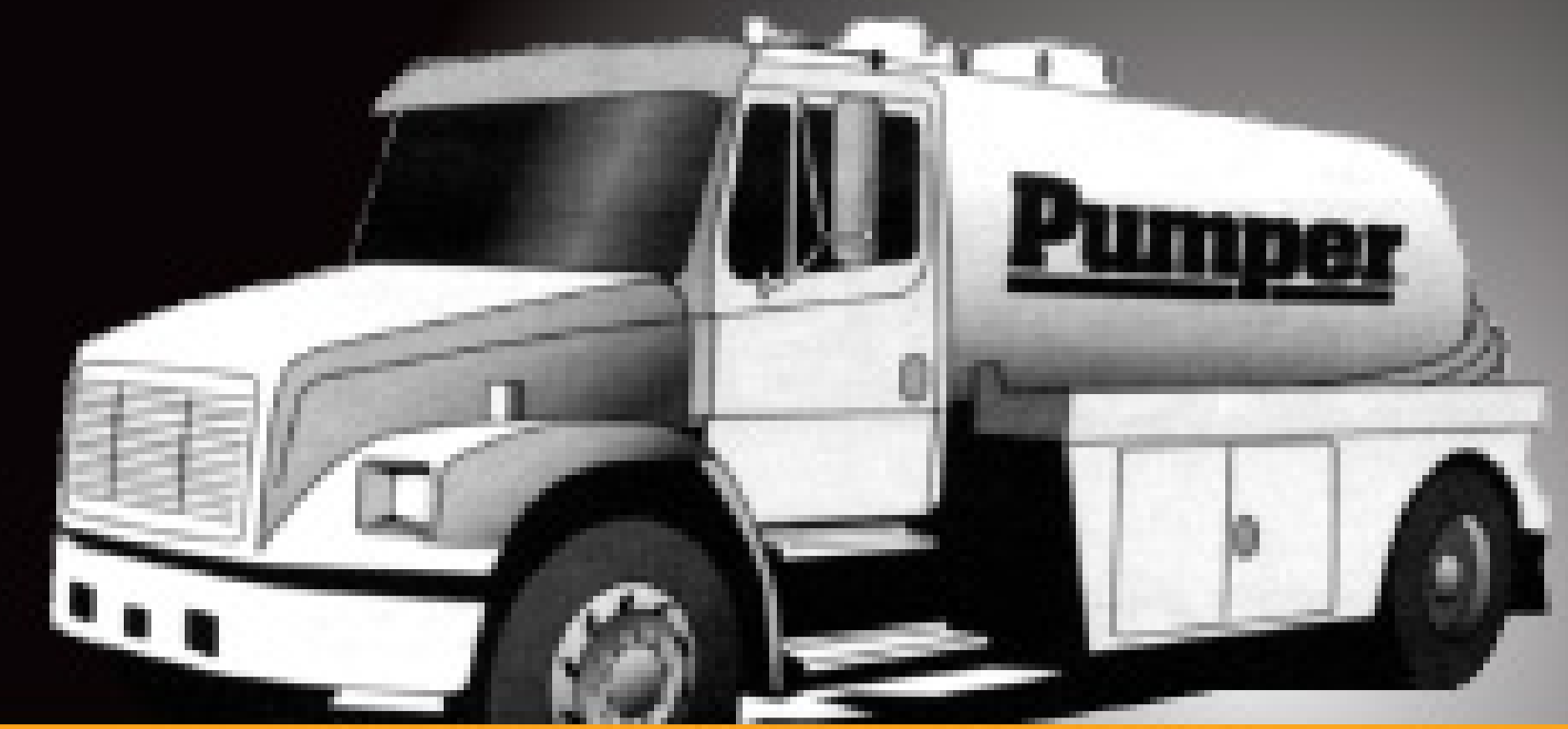

February



1999 Peterbilt: 12.7 Detroit, 470 hp, 129K miles, AC, cruise, 10-spd., Jake brake, 18 front, 46 rears, Hendrickson susp., new 4000 gal. tank & Masport 400 vac pump, complete new unit, new paint & tires. Financing available.....\$79,000
877-898-5104
hullstruckbodies.com P2



1996 Ford L9000 Vac Truck: M11, 300 hp, 9-spd., 18/46 on rubber, blk. susp., 47,537 miles, vac unit 1993, model STK#A04137.\$49,500
Mark's Truck Sales
888-588-2933 P2



2004 VacCon International: 827 Roots, 1300 gal. water, 12-yd. tank w/high dump, 80 gpm @ 2000 psi.\$225,000
Call Mike 772-216-4020 P2



1989 Mack: Diesel, 8-spd. trans., Jake brake, 3000 gal. Coleman built in 1997, 400 cfm, Coleman pump. Location NY.\$29,900
Call Judge Coleman
516-398-5638 P2



1997 GMC C Series: Gas 6.0 V8, 5-speed/2-speed rear, 4-wheel disk, 26,000 GVWR, 110,000 miles, 1,000 gal. tank, 120 gal. separate water tank. Located in SW PA.\$18,000
724-640-0998 P2



Retiring, Selling Equipment 1994 Vactor: PD blower type, works every day, very reliable. Call for more info.\$38,500
630-444-1590 P2



2006 Ford F-550 4x4: 875 gal. (300 fresh/575 waste) Imperial tank w/2-place toilet carrier. Diesel, auto, air, XL pkg. Excellent condition. Only 61,300 miles.\$48,995
Call 800-722-7382
Commercial Sales P2



1984 GMC Camel Jet: 210 hp 3208 CAT, 1500 gal. water @ 80 gpm, pump @ 2500 psi, 9-yd. debris box w/5000 cfm Roots blower.\$8,000 OBO
814-825-6000 P2



2000 Mack: With 330 hp, 10-spd. with auto. shift, new 3600 gal. aluminum tank, R260 Juro-Pak, storage cabinet passenger side.
800-722-8384 PBM



1997 Ford LN 8000 Vac-Con: Low miles, Allison trans., 3-stage fan, 12-yd. debris, 1500 gal. fresh water for jet, 30 gpm @ 2500 psi. Well maintained, ready to work.Price Reduced to \$51,500
Call Don 954-943-9100 P3



1987 GMC 7000: 150,000 miles, 1200 gal. tank, 150 gal. fresh water, hoist, 25" manway, 3" inlet, 6' dump.Asking \$20,000
Call David 309-937-5559
or 309-507-0411 P2



2000 Pioneer: 6300 gallon vacuum/pressure semi trailer. Location: NY.\$37,500
Call Judge Coleman
516-398-5638 P2



O'Brien Trailer Jetter 3518-SC: 65 hp Cummins, single axle, 350 gal. poly tank, pump: 18 gpm @ 4,000 psi, 400' of 1/2" hose, 20' leader hose, 4.0 hrs.\$37,000
407-481-2750 P2



1999 Sterling: Cummins engine w/warranty, 8-LL trans., 4,500 gal. Jay's tank w/Battioni 720 pump, Berkley irrigation system, cold weather unit. Located in Wisconsin.....\$75,000
800-872-2915 P3



2000 Freightliner Pumper FLC112: 515,938 miles, diesel engine, 5-10 Fuller, 4000 gal. tank, Masport HXL400WV, 400 cfm pump, Jetter: 13.5 hp, triplex pump, 4.8 gpm @ 3,000 psi.\$65,000
407-481-2750 P2



1998 GMC Cues TV System: Approx. 1,700 L.F. of multi conductor cable, pan & tilt, Shorty transporter, washdown system, lots of storage. Good condition. Ready to work.\$55,000
Kelly 608-279-2299 P2

Pumper

see photos in COLOR at www.pumper.com

TRUCK STOP



February



Shower and Restroom Trailers: Platinum and Gold Series, new and used available. Each with separate men and women sides.

CCI/Brian Touey 805-896-3777 PBM



2005 F550 4X4 Diesel: 6-spd., XL package, 950 gal. tank, 600 waste, 200 chemical, 150 fresh, 2-place toilet rack, 93,000 miles, H2 Masport pump\$35,000

Call Ryan at 801-430-7287 P2

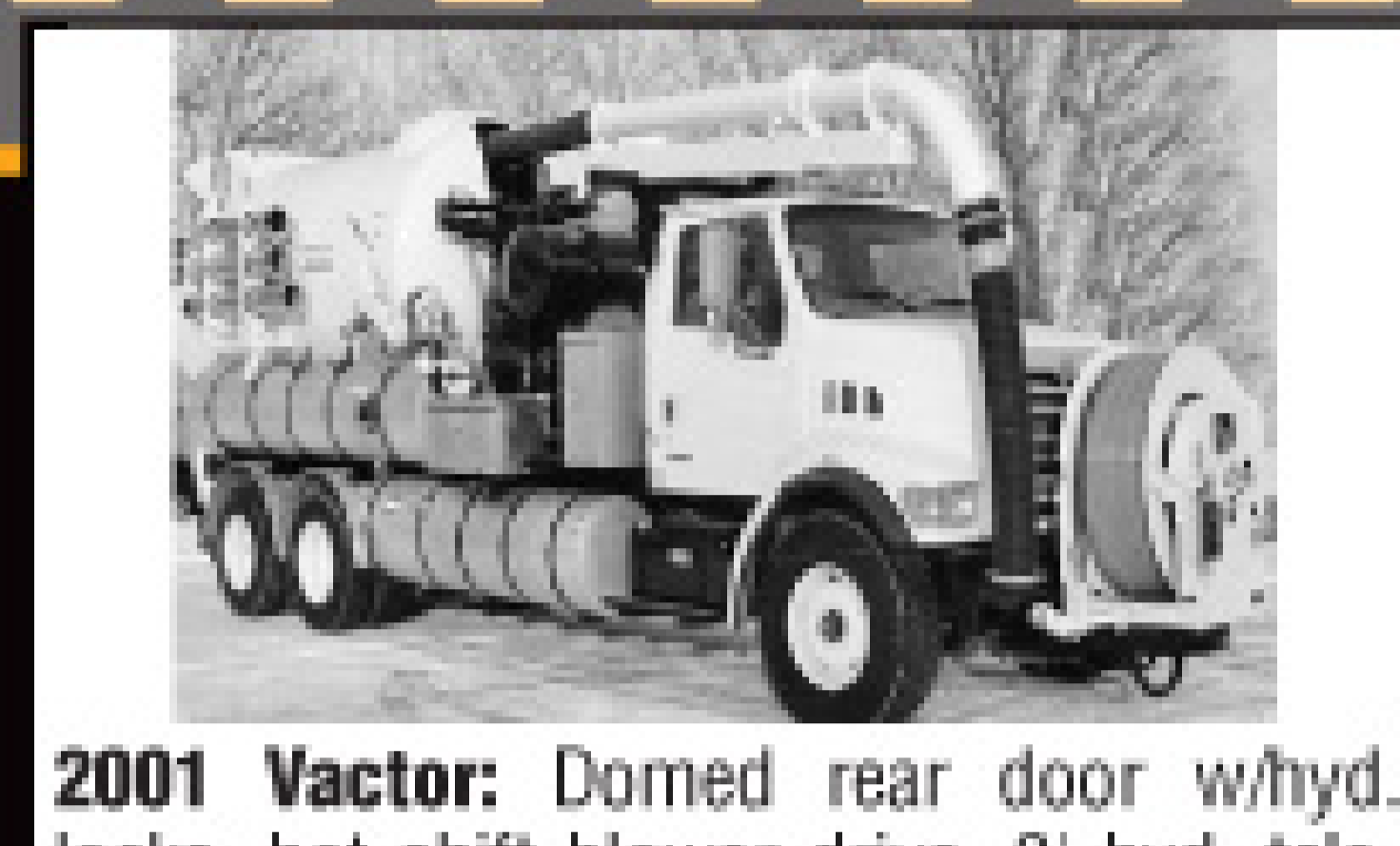

2001 Vector: Domed rear door w/hyd. locks, hot shift blower drive, 8' hyd. telescopic boom, tele/ rotating hose reel, debris body flushout, handlight w/bumper plug, folding pipe racks, street curb, retract. hand gun reel, low water alarm w/light.

Call Joe 312-208-6373 P2



Vector 2110 Mounted on a Ford L8000: Fold-down pipe racks, debris body flushout. Call for many other options not listed. (Stock 1453)\$32,500

Call Joe 312-208-6373 P2



2001 International Septic/Grease Pump Truck: Cummins 400 hp, 8-spd. trans., Presvac 4200 gal. w/200 gal. fresh water for Harben jetter. 4000 psi, 300' jet hose, 400 cfm Demag vac. pump.

.....Price Reduced to \$59,500

Call Don 954-943-9100 P3



1999 Vector 2100 on a Sterling Chassis: CAT 3126 engine, Allison auto. trans., 80 gpm @ 2500 psi, accumulator, debris body flush-out, 4' extend. boom, fold-down pipe rack. (Stock 1445)

Call Joe 312-208-6373 P2



1995 IH DT 466: 6-speed, 2200 gal. tank, 120 gal. fresh, 7 years old, 360 National pump, 247,000 miles. PA.\$19,500

814-669-4175 P2



1998 Vector 2100: 1998 International model 2554 chassis, IH 530 E, 275 hp engine, Fuller RT8908LL trans., fold-down pipe racks, 80 gpm @ 2500 psi water sys., hydraulic rear door locks. (Stock 1444)

Call Joe 312-208-6373 P2



2007 Sterling Cab: With 3600 gallon aluminum P/V tank with Juro-Pak R260.

.....\$116,000 including FET

800-722-8384 PBM



2004 Freightliner FL112 King Vac: 5000 psi pressure washer, blow-off system, hyd. vibrator, 3,000 gal. tank, 205K miles, 6362.8 eng. hrs.\$195,000

Harold 504-201-4257 P2C3



1991 International Septic Truck: 3600 gal. tilt/open tank, new Masport pump, new paint, nice truck.\$28,000

814-277-6227 P2



1996 International DT-466: 33,000 GVW, new 2100 gal. LMT vac. tank, 20' manways, Masport HXL 75WV water cooled pump, heated valves 3" & 4", LED lights.

.....\$28,000

Call Tim @ LMT 1-800-545-0714 P2



2007 Freightliner Pumper M2106: 9655 miles, 7.2 Mercedes diesel, manual transmission, 4200 gal. tank, JuroP 50 cfm pump, jetter: General pump, 10 gpm, 2,000 psi, 150' hose\$115,000

407-481-2750 P2



2001 International 4900 DT466: 7-spd., 101,000 miles, new 3500 gal. tank with JuroP R260 pump. Super clean truck.Asking \$66,000 - Financing Available.

888-892-9164 P2



2004 Pik-Rite 3550 Gallon Tank: Or will sell complete including truck: 2004 Freightliner, 73,000 original miles. Both in excellent condition.

610-381-3114 P2



2000 International 4900 Nearing Completion: DT466/225 hp, manual trans., NEW 2500 gal. vacuum body, Masport 400 cfm vac. pump, 24"x24"x60' alum. tool box, 100' 3" suction hose.\$39,400

Call Terry 734-777-0390 P2

Pumper TRUCK STOP

see photos in COLOR at www.pumper.com



February



1999 IHC 8100: New 2500 gal. carbon steel tank, new NVE pump package, 6' dump, 4" inlet, 36" rear manway, Cummins M-11 350 hp, standard trans., 32,000 GVWR.....\$41,250

352-323-6284 X 201 P2



1997 Ford 9000 LTL: 425 hp, 18-spd. transmission, full floatation tires, new 4000 gal. Husky tank in 2005, only 2 years in service.....\$70,000

506-785-6755 P2



1998 IHC 4900, Sreco HV-2000 Sewer Jet: 6 cylinder John Deere diesel upper, DT-466, Allison automatic, 55,115 miles, 1,894 hours. ..\$39,900

814-696-4343 - Hollidaysburg, PA P2



1999 F-450 Toilet Service Unit: Fresh water washdown pump, newer brakes, pump and tires, new aluminum tool boxes. Will paint to suit.

Call Terry 734-777-0390 P2



2002 Sterling: C-12 Cat, 410 hp, new 3500 gal. tank and Jurup R260 364 cfm vac pump, new paint & tires, beautiful truck.

.....\$62,000

877-898-5104
hullstruckbodies.com P2



2002 FL60 Freightliner: 180K miles, 3126 Cat motor, new clutch, trans., A/C compressor. 1500 gal. waste, 200 gal. water, new MEC 8000 pump. Lots of extras. Please call!

\$47,400 OBO

830-560-0021 P2



2000 Freightliner FLD 112: C-10 CAT 370 hp w/Jakes, 10-spd., 12 FA/40 RA air-leaf susp., new 80 BBL vac tank with new 350 cfm liquid cooled Wallenstein vac pump. Excellent condition and ready to work. Only 370,000 miles!!

\$61,500 OBO

303-772-4019 P2



1990 Ford Tri-Axle Pump Truck: 350 Cummins, 8LL trans., 5,000 gal. tank, heated valves, 6" dump valve. Good condition.

\$21,500

800-858-3111 P3



2007 International 7600 w/Vactor HXX2112: Hibon 8702 PD blower, 20 gpm, 2500 psi Cat pump, 940,000 BTU water heater, 1300 gal. tank, dual hose reels, C13 Cat 430 hp w/Jake, 20,000# front, 46,000# rears on Hendrickson, 252 hrs., 7336 original miles! New Holland, PA.

Daryl Martin @ 717-354-3199 P2



1994 Ford 800: 2200 gal., good starter truck, diesel, in use now, Transway system. Northeast Ohio.....Asking \$18,000

440-998-7448
or Cell 440-812-0045 P2



2000 International: 800 gallon waste, 250 water tank, new pump, 2-unit carrier, 110K. Located in MD.....

\$16,500

Call Doug @ 410-310-5151 P3



1998 GMC 7500 Series: Cat motor, 7-spd., 106,000 miles, Masport water cooled pump, 2500 gal. Abernethy steel tank, good brakes and tires, excellent truck. Always garage kept

\$39,500

631-254-4777 P2



2006 F-350 Gas 4x4: 10,000 miles (factory warranty), 225 waste, 100 fresh, Battioni pump, DC-10 washdown, 5.5 Honda, 8-toilet trailer, 10 toilets, 1 hand sink, 1 carrier.....

\$37,000

315-375-7867 P2



2001 FL70: 250 hp Cat, 182K miles, 2500 gal. tank, NVE Challenger pump, new tires and brakes. Great truck!

\$38,500

Call Nights at 804-781-0118 P2



2000 Peterbilt 385 Pumper Truck: Cat C-12, 400 hp, 10-spd., 3800 gal. tank, 367 cfm Jurup pump, jetter sys. 3000 psi, 10 gpm, alum. wheels, AC/CC, step bumper, vac hoses, 100 gal. water tank, new engine bearings, electric reel, 150'. \$75,000 OBO

269-629-4669 P2



1999 Hino: 650 gallon waste, 250 water tank, 170K. Located in MD.

\$15,000

Call Doug @ 410-310-5151 P3

PLACE YOUR AD ONLINE AT www.pumper.com - IT'S ALWAYS THERE TO MEET YOUR BUSY SCHEDULE

Pumper TRUCK STOP

see photos in COLOR at www.pumper.com



February



1996 GMC W7 Keith Huber Unit: 3-compartment 1400 waste 300/300 fresh, DC-10 washdown pump, 2-unit rear carrier, 123,000 miles.\$20,000 OBO
269-435-4611 - Constantine, MI P2



1999 Peterbilt 379: Super 10, air ride, Challenger 506 pump. 2005 Long Horn trailer: 7000 gal., alum. vac/pressure tank, air ride, digital level gauge.\$130,000
805-643-7871 P2



1999 Ford F550: 7.3 power stroke diesel, roll-off truck, 198,000 miles, A/C, auto, 12V DC water pump, 500/100 tanks, heavy duty suspension, includes box van.
904-276-4829 P2



1995 Ford LTL-A: 375 hp Cummins Super 10-spd., 4000 gal. tank w/2000 gal. freshwater, excellent rubber, runs & drives like a new truck, 91,000 actual miles. \$72,500
(I will be in Louisville at show)
763-441-5251; Cell 612-221-6416 P2



1993 Isuzu NRR: 400 waste, 400 fresh, DC-10 washdown pump, 2-unit rear carrier, 236,000 miles.\$10,000 OBO
269-435-4611 - Constantine, MI P2



2005 International 7500: Del Zotto 10-ton Hydrabrut. Truck is like new with 5,000 miles.\$115,000
850-670-5790 P2



2000 Sterling Pump Truck: Cat C-12 engine, 400 hp, 196,000 miles. 3500 gal. steel tank and pumps installed in October, 2007. New paint.\$75,000
850-670-5790 P2

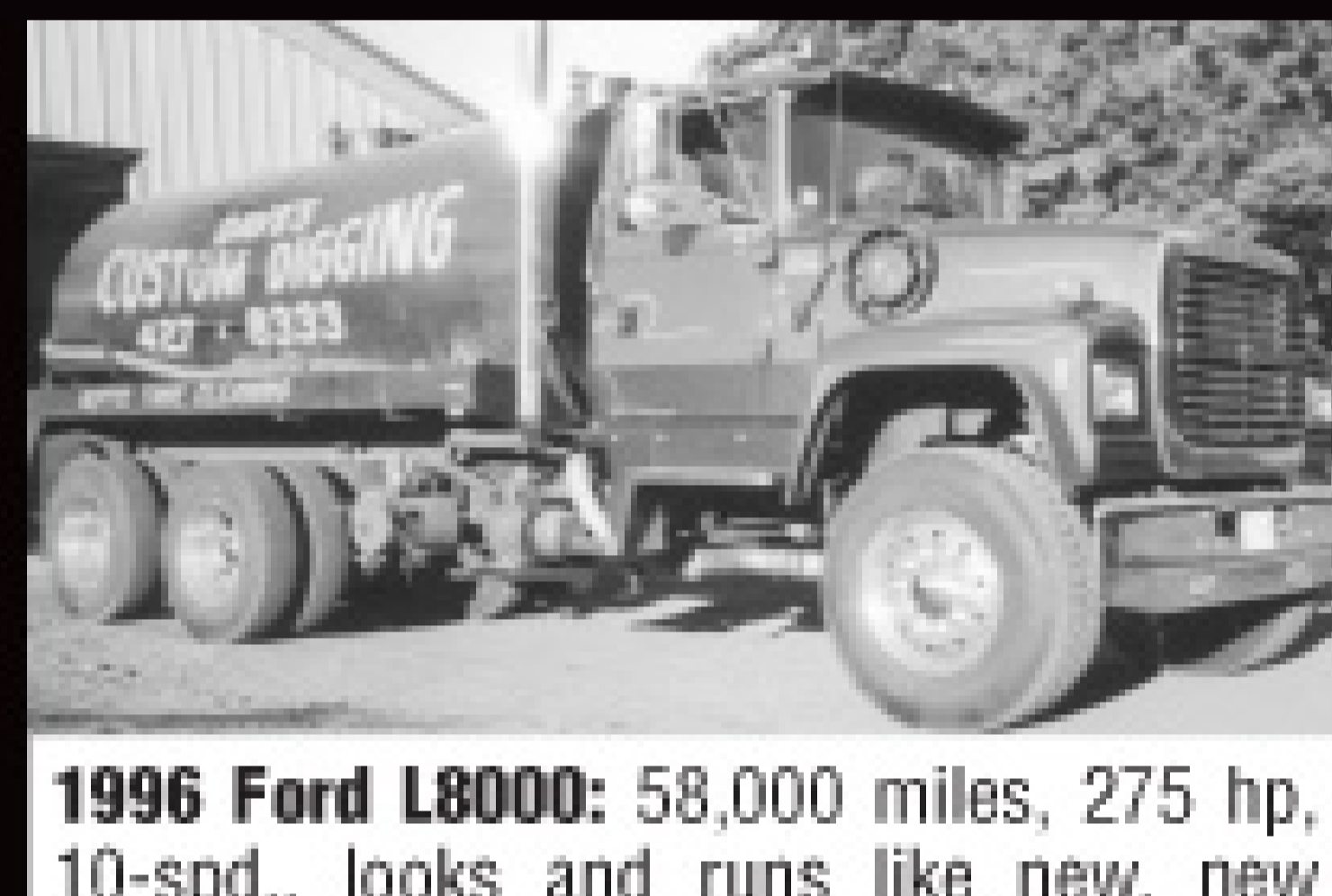

1996 Ford L8000: 58,000 miles, 275 hp, 10-spd., looks and runs like new, new 4,000 gal. tank, 36' manway & hoist.\$72,500
(I will be in Louisville at show)
763-441-5251; Cell 612-221-6416 P2



1995 International 8200 Series: M11 330 hp Cummins, 10-spd., air ride, 2,000 g. IME carbon steel tank w/hoist & hydraulic rear door, Pearson vac pump, non-code. First reasonable offer.
Call Ryan at 989-233-7650 P2



2004 Vector HXX Hydroexcavator: Excellent condition; three to choose from.
330-270-9900 Ext. 3 CP2



2001 International 4700 466E: 5-spd. w/overdrive Allison 2000P, 2200 gal. vac. tank, Moro M-10 230 cfm, great condition, all new tires, 61,000 miles, Arizona - no rust.Asking \$39,500
520-378-9569 P2



2003 Ford F550: 4x4, auto, 137,000 miles, diesel, Satellite MD950 tank, 2-toilet rack, Burkes DC10 water pump with hose reel, Conde pump.\$27,990
231-924-8994 P2



1984 Terragator 2505: New 4500 gallon Balzer tank, 5 wheeler, 6600 tires, 8000 vacuum pump new with tank. In Ritchie Bros. Orlando Auction Feb. 19-23, 2008. Questions call:
239-693-6600 P2



1982 Big A: 903 engine, 20 hrs., 3500 gal. tank, 4x4, 6600 floaters, Moro vacuum pump. In Orlando @ Ritchie Bros. Auction Feb. 19-23, 2008. Questions call Karle Enviro at:
239-693-6600 P2



1989 International VAC Pump Truck: 2500 gallon tank, tag axle, Jurop pump.Asking \$20,000
Call Jay 203-437-1443 P2



1999 Mack: 350 hp Mack engine, 10-spd., AC, cruise, air ride, new 3500 gal. tank, Jurop R260-364 cfm vac pump, new paint and tires.\$53,000
877-898-5104
www.hullstruckbodies.com P2

Pumper see photos in COLOR at www.pumper.com TRUCK STOP



February



1999 Freightliner FL112: Cat C12 engine, 105,000 miles, 4300 gal. alum. tank, Wittig pump, Eaton-Fuller trans., cruise, AC, good rubber, ready to work...\$62,500
317-374-9433 P2



1987 Saab Scania H112: 309 hp, 18 FA, 44 RA, 3600 gal. tank new in '98, Utile L62S 393 cfm pump new in '06, new clutch, brakes, 336,000 miles.\$20,000
802-343-1657 P2



1984 Freightliner: 350 Cummins, 3000 gal. Cusco 1990 530 cfm Moro pump, full opening rear door with hoist, coded DOT.\$25,000
336-697-8169 P2

THIS SPACE CAN BE YOURS!

Just go to
www.pumpertrader.com
or www.pumper.com
and fill in the online form.

**BE ONLINE AND IN PUMPER AND PUMPER TRADER FOR ONLY \$125!
JUST FILL OUT THE FORM BELOW,
OR GO TO www.pumper.com OR www.pumpertrader.com
and fill in the online form!**

BE ONLINE & IN PUMPER, CLEANER OR MSW FOR ONLY \$125! Please print ad legibly with correct punctuation and PHONE NUMBER. Don't forget to send photo!

RATE \$125 PER AD, PER MONTH, PER PUBLICATION WITH A 30-WORD MAXIMUM – **PLEASE NOTE:** You can only advertise **ONE TRUCK** for sale per ad.

DEADLINES **PUMPER: 10TH OF THE MONTH • CLEANER & MSW: 1ST OF THE MONTH** – For example: Jan. 1st would be the deadline for Feb. Cleaner.

ADVANCE PAYMENT **NO BILLING FOR TRUCK STOP ADS.** Payment must be received in **ADVANCE** before publishing.

Enclosed is \$ _____ for _____ ad(s) to run _____ month(s) in

PUMPER/Pumper Trader MSW CLEANER ALL 3 PUBLICATIONS (TRIPLE DOLLAR AMOUNT)

Company Name _____

Address _____ Phone _____

City _____ State _____ Zip _____

• **MAIL** this completed form with payment and photo to:
COLE Publishing Inc., P.O. Box 220, Three Lakes, WI 54562
(Make check/money order payable to: COLE Publishing Inc.)

• **ONLINE** ad form at: www.pumper.com; www.pumpertrader.com,
www.cleaner.com, www.mswmag.com

• **FAX** this completed form to: 715.546.3786 and **E-MAIL** photo to:
truckstop@mswmag.com, truckstop@pumper.com, truckstop@cleaner.com

PLEASE FILL OUT CREDIT CARD INFORMATION COMPLETELY:

CREDIT CARD NO. _____ V-CODE _____ EXP. DATE _____

CARDHOLDER NAME _____ PHONE _____

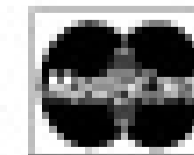
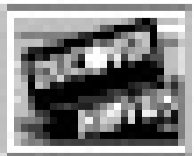
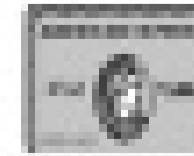
PLACE YOUR AD ONLINE AT www.pumper.com – IT'S ALWAYS THERE TO MEET YOUR BUSY SCHEDULE

\$ WE'VE GOT THE MONEY \$

For All Your New and Used Equipment Needs



CHUCK TERRITO

- > APPLICATION ONLY TO 250K
- > SIMPLE APPROVAL PROCESS
- > LEASE OR LOAN OPTIONS
- > NEW & USED EQUIPMENT
- > FLEXIBLE FINANCE OPTIONS
- > START UP PROGRAMS



MIKE RAUSCH



Come visit us at
Booth 7104

Fax this E-Z application to **406.892.5072**, or give us a call, and we will get your financing approved for the show.

Company Name: _____ Owner/Contact: _____

Address: _____

City: _____ State: _____ Zip: _____

Phone: _____ Best time to call: _____

Let us put our 35 years of experience to work for you!

Call today and see why...

IT PAYS TO LEASE WITH US!



800.246.7997
www.graniteleasing.com

Training & Education

By **Scottie Dayton**

Guidelines to Minimize Crashes

A white paper from the Occupational Safety and Health Administration, *Guidelines for Employers to Reduce Motor Vehicle Crashes*, covers how to calculate the cost of motor vehicle crashes, examples of workplace driver safety programs, a 10-step program to minimize crash risk and how to promote safe driving practices. It discusses what constitutes aggressive, distracted and impaired driving and tells how to recognize signs of fatigue to prevent driving drowsy. Visit www.osha.gov/Publications/motor_vehicle_guide.html.

Effluent Pumps for Onsite Systems

The Sump and Sewage Pump Manufacturers Association is presenting "Effluent Pumps for Onsite Wastewater Treatment: Selecting the Right Pump for the Job," a non-credit training program, on March 14 as part of the Illinois Plumbing Heating Cooling Expo at the Drury Lane Conference Center, Oakbrook Terrace, Ill. The program is in its certification stage and will become eligible for CEUs. Call Bev Potts at 800/795-7422 or visit www.ilphcc.com.

Florida

Courses are at the Florida Onsite Wastewater Association's Training Center in Polk City unless stated otherwise. An asterisk indicates Master credit hours are available.

- Feb. 6 – 64E-6 Let's Look at the Code, Hialeah
- Feb. 7 – 64E-6 Let's Look at the Code, Tampa
- Feb. 11 – Artificial Media Treatment Technologies
- Feb. 12 – Natural Media Treatment Technologies
- Feb. 18-19 – *Master III-Basic Florida Soils
- Feb. 20-21 – *Master I-System Design & Function
- Feb. 21-22 – *Master II-System Materials & Regulation Requirement
- March 6 – *Master Contractor Maintenance
- March 11 – Onsite Systems: How Are They Approved?, northeast Florida (TBD)
- March 12 – Onsite Systems: How Are They Approved?, southwest Florida (TBD)
- March 25 – Work Smart, Not Hard, southeast Florida (TBD)
- March 26 – Work Smart, Not Hard, southwest Florida (TBD)

Contact FOWA at 407/830-4381 or www.fowaonsite.com.

Iowa

The Iowa Onsite Wastewater Training Center has the following courses:

- Feb. 20 – Basic 101, Storm Lake
- March 17 – Basic 101, Calmar
- March 27 – Media Filters, Indian Hills
- May 14 – Drip Irrigation Dispersal Systems, Ankeny

Call Annette Adams at 800/362-2127, ext: 6464 or e-mail Dennis Hayworth at dahayworth@dmacc.edu.

Minnesota

The University of Minnesota Extension has these hands-on workshops:

- Feb. 5-6 – Design-Continuing Education, Sauk Centre

- Feb. 5-7 – Design and Large System Combo, Continuing Education, Sauk Centre
 - Feb. 6-7 – Cluster-Continuing Education, Sauk Centre
 - Feb. 11-13 – Pumping/Maintaining, Grand Rapids
 - Feb. 14-15 – General-Continuing Education, Detroit Lakes
 - Feb. 21-22 – General-Continuing Education, Two Harbors
 - March 11-12 – General-Continuing Education, Willmar
 - March 14 – Contractor Safety/Pipelayer Certification, Continuing Education, Mankato
 - March 25-26 – Pumping/Maintaining-Continuing Education, Brainerd
 - March 31-April 1-2 – Introduction To Onsite Systems, Bemidji
 - April 3-4 – Installing Onsite Systems, Bemidji
 - April 11 – Contractor Safety/Pipelayer Certification, Continuing Education, Little Falls
 - April 14-15 – General-Continuing Education, White Bear Lake
 - April 16-18 – Designing Onsite Systems, Detroit Lakes
 - April 22-23 – Inspecting Onsite Systems, Waseca
 - April 28-30 – Introduction to Onsite Systems, White Bear Lake
- Call 800/322-8642 (612/625-9797) or visit www.extension.umn.edu.

Missouri

Missouri Smallflows Organization is offering an Operation & Maintenance course on Feb. 19-20 at Hillsboro. The course provides CEUs to renew onsite registration with the Missouri Department of Health and Senior Services. Call 417/739-4100 or e-mail mso@lvbw.net.

North Carolina

North Carolina Soils and On-Site Wastewater Training Academy is offering the following courses at Raleigh unless stated otherwise:

- Feb. 14-15 – Onsite Wastewater System Inspector
- April 22-24 – Land Application/Biosolids Operator Training
- April 23-25 – Subsurface Wastewater Operator Training
- May 20 – Introduction to Decentralized Wastewater, Fletcher
- May 21-22 – Onsite Wastewater System Inspector, Fletcher

Call Joni Tanner at 919/515-1678 or visit www.soil.ncsu.edu/training.

Pennsylvania

The Pennsylvania Septage Management Association offers the following training on March 19-20 at Grantville:

- Vac-Truck Training and Certification
- Basic Onlot Wastewater Treatment System Inspection
- Advanced Onlot Wastewater Treatment System Inspection
- Standards Refresher

New Jersey Septage Management Association members qualify for PSMA member tuition fees. Call Jackie at 610/350-0590 or visit <http://psma.net>.

Washington State

The Washington On-Site Sewage Association and Washington State Department of Health in cooperation with Washington State University are offering these certification courses at the training center in Puyallup unless stated otherwise:

- Feb. 6-7 – Basics of Onsite Sewage, Centralia
- Feb. 14 – Construction Safety
- Feb. 20 – Basics of Maintenance, Port Angeles
- Feb. 28 – Design/Install Subsurface Drip Systems, Spokane
- March 5 – Markup and Profit

- March 13 – Control Panel Wiring
- March 19-20 – Exam Review
- April 2 – Maintenance Basics
- April 16 – Pumpers
- April 23 – Design/Install Subsurface Drip Systems
- May 6-7 – Combined Basics of Onsite Sewage
- May 14-15 – Installation Basics, Part 2
- May 20 – Mounds/Sand Filters
- May 22 – Maintenance Basics, Bremerton

Call John Thomas at 253/770-6594 or visit www.wossa.org.

Wisconsin

Wieser Concrete has a six-hour, general continuing education seminar that provides the necessary credits for installers, sanitarians, designers, and others working in the onsite wastewater treatment field,

- Feb. 28 – Portage
- March 6 – Shell Lake
- March 13 – Fond du Lac
- March 20 – Wieser Concrete Maiden Rock Facility
- March 28 – Rhinelander

Call 800/325-8456 or visit www.wieserconcrete.com.

Association News

FLORIDA: FOWA Names New Director

After seven years as the executive director of the Florida Onsite Wastewater Association, Bill Carson stepped down on Dec. 31, 2007, to manage the organization's annual convention and trade show. Roxanne Groover, former director of education, engineering, and public relations, is the new executive director. Contact her at 863/956-5540 or e-mail grooverroxanne@aol.com.

IOWA: Association Reverts to Individual Memberships

The Iowa Onsite Wastewater Recycling Association membership has reverted to individual rather than company memberships. Dues include a membership to the National Onsite Wastewater Recycling Association, enabling members to take the Certified Installer of Onsite Wastewater Treatment Systems testing sponsored by the National Environmental Health Association. "Being able to sit for the exam was the reason we changed the membership structure," says president Bob McKinney.

MICHIGAN: Association Forms PAC

The Board of Directors of the Michigan Septic Tank Association has formed a political action committee to advance its goals. Committee members J.P. Fountain, treasurer, Chanin Frank, record keeper, Joe Hall and Rick Throop are filing the papers and establishing a bank account for the PAC. The organization has a legal advisor and legislative lobbyist. Associations considering forming a PAC may contact Fountain at 231/796-3146 or Eloise@netonecom.net.

WASHINGTON: County Certification Testing

The Washington On-Site Sewage Association is working with many marine counties and some beyond to establish standardized certification testing, and is proctoring numerous tests for them. Testing is by appointment based on the schedule of the applicants. Tests are graded while candidates wait and an exam certificate is usually issued before they leave. WOSSA also notifies the county of the results.

The association has rewritten many of its training classes to include more hands-on activities based on responses from more than 2,000 class attendees in the last few years. Activities include assembling pressure distribution systems, startup procedures, setting up timers and panels, and troubleshooting. ■

C A L E N D A R

Feb. 13-14

Nebraska On-Site Waste Water Association Annual Convention and Trade Show, Embassy Suites Hotel, Lincoln. Call Diane Snapp at 402/476-0162.

Feb. 14-15

Utah On-site Wastewater Association Convention, E-Center, Murray. Call Judith Sims at 435/797-3230 or visit www.neng.usu.edu/uwrl/training.

Feb. 15-16

Wisconsin Onsite Wastewater Recycling Association Convention, Country Springs Hotel, Waukesha. Call 608/256-7757 or visit www.wowra.com.

Feb. 27-March 1

Pumper & Cleaner Environmental Expo International, Kentucky Exposition Center, Louisville, Ky. Education Day Feb. 27; exhibits open Feb. 28-March 1. Call 800/257-7222 or visit www.pumpershow.com.

March 2-4

Ontario Onsite Wastewater Association Conference, Deerhurst Conference Centre, Huntsville. Call 905/372-2722 or visit www.cowa.org.

March 3-5

Minnesota Onsite Wastewater Association Convention, Cragun's Resort, Brainerd. Call 888/810-4178 or visit www.mowa-mn.com.

March 11-13

Northeast Onsite Short Course, Marriott Hotel and Spa, Groton, Conn. Call 978/323-7929 or www.neiwppcc.org.

March 24

Granite State Designers and Installers Association Septic System Conference & Exhibition, Radisson Hotel, Manchester, N.H. Call 603/228-1231 or visit www.gsdia.org.

April 7-10

National Onsite Wastewater Association Conference, Cook Convention Center, Memphis, Tenn. Call 800/966-2942 or visit www.nowra.org.

April 15-17

North Carolina On-Site Wastewater Treatment Conference, North Carolina State University, Raleigh. Call Joni Tanner at 919/515-1678 or visit www.soil.ncsu.edu, then Training, Short Courses and Workshops.

April 27-May 2

North American Society for Trenchless Technology No-Dig Show, Gaylord Texan Resort and Convention Center, Grapevine, Texas. Visit www.nodigshow.com.

May 12-15

California Onsite Wastewater Association Conference and Exposition, DoubleTree Hotel, Sacramento, Calif. Call or visit 707/579-4882 or visit www.cowa.org.

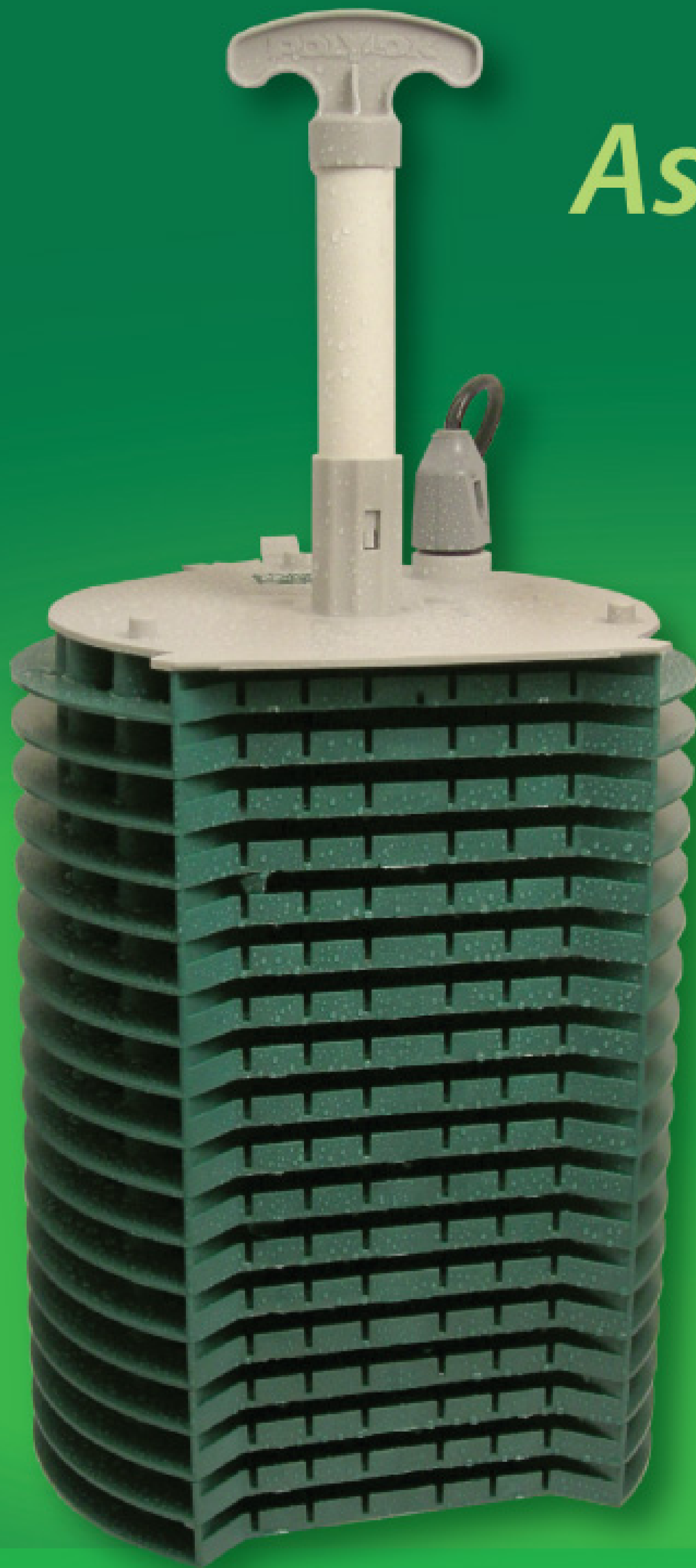

As Green as it Gets!

For all your Onsite
Wastewater Needs



Booth 3115



Filter Alarms



Pumps



Pre-Assembled Basin



Flow Controller



Orifice Shields



1-800-701-3942

For a Free catalog or to see other products call or visit our website: www.zabelzone.com

PERFORMANCE IS EVERYTHING



When you're in the driver's seat, performance is what counts.

Quick response time ~ Products built to last ~ Crowd-pleasing innovations

PolyJohn's high-performance team has everything you need to stay on track and ahead of the competition. Plus, the best pit crew in the field with our expert area business managers there to personally help you win the race.



Stop by our booth in Louisville and race against Formula One Champion, **Felipe Massa**, who will set the "time to beat" on our racing simulators.

Feel the excitement, hear the crowd roar as you watch "racing challengers" try to beat his time at The 2008 Pumper Show, February 28 - March 1. You may even be able to sit in the driver's seat yourself! Sign up today! Limited pole positions are available at www.polyjohn.com. Prizes will be awarded.

Check us out at Booth 403!!

IN YOUR DRIVE TO BE THE BEST, WE'RE THERE WHEN YOU NEED US!

800-292-1305
www.polyjohn.com

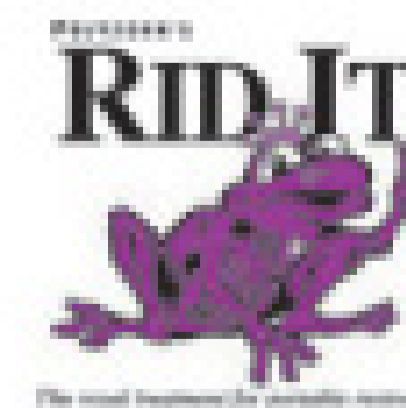

EARN MORE • SELL MORE • SERVICE BETTER

PRESVAC

**The Leader
In Vacuum
Technology**

Bright finish Aluminum Tanks
for the Septic Pumping
Industry... Standard
tank models from
2,000 gallons
to 5,000 gallons.



Hydro-Trencher - 5300 CFM air flow/28" HG vacuum
with 8" hydraulic actuated boom, 3000 U.S. gal.
debris tank (stain. steel 316), 1000 U.S. gal.
water tank (stain. steel 316), 9 G.P.M. water
pump with pressures to 5800 p.s.i.

Powervac 5300 for wet/dry operation

5300 CFM air flow/28" HG vacuum, Dump chutes
extended to rear of truck, Stainless steel 316,
DOT 407/412



Liquid Truck

Designed for industrial liquid applications

www.presvac.com



Booth 1154

Nationwide Sales & Service
Call a Presvac Dealer in Your Area!

4131 Morris Drive • Burlington, Ontario, Canada L7L 5L5 • Fax: 905-681-0411

905-637-2353 • 800-387-7763