

# Pumper

DEDICATED TO THE LIQUID WASTE INDUSTRY

January 2008 www.pumper.com \$5.00 U.S.

## SPREADING the WORD

Michigan hauler  
promotes responsible  
land application

PAGE 36

## On the Road Again

Texas pumper  
in it for  
long haul

PAGE 70

Louisville 2008  
Feb. 27-29, March 1 MAKE YOUR MOVE

## IT'S ALL HERE!

Exhibitors provide  
look at industry's  
latest technology

PAGE 58

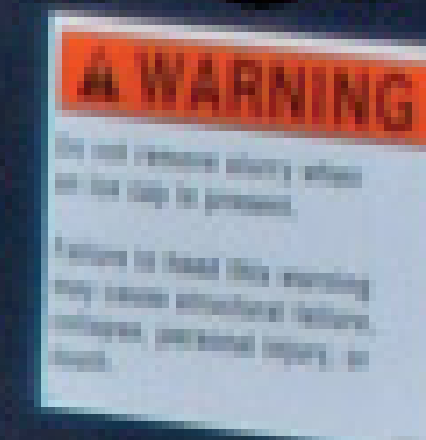



EXPAND YOUR BUSINESS  
TO WHEREVER THE OPEN  
ROAD WILL TAKE YOU.



THE SYNERGY WORLD

**HIGH TECH II**  
DELUXE FLUSH TRANSPORT

THE MOST AFFORDABLE,  
HIGH-END, RESTROOM  
TRANSPORT AVAILABLE.



There's no better way to cater to the special event market than with the High Tech II Deluxe Flush Transport (D.F.T.) – a heavy-duty drop-axle trailer fitted with two top of the line High Tech II Deluxe Flush units.

SUPERIOR DESIGN & AMENITIES		MORE AFFORDABLE, NO ELECTRIC HOOKUP NEEDED	
			
Poly Unit with Flush	<b>High Tech II Deluxe Flush</b>	Powered Trailer Unit	More affordable than power-dependent trailer units, superior flush system over other poly units, best amenities available for comfort

On site, the D.F.T. secures the restrooms only two inches off the ground making setup a breeze. Inside, you'll find the modern amenities of the High Tech II such as the industrial grade flushing system and clean-water handwash. Simply fold down the hitch, raise the platform and the D.F.T. is ready to head off to its next destination.

Contact your area sales manager at (800) 352-1986 or visit us on the Web at [PORTABLETOILET.NET](http://PORTABLETOILET.NET) for more details...THE FUTURE IS HERE, TODAY.



SEE US AT THE SHOW  
IN LOUISVILLE, KY  
**BOOTH 1122**

To learn more, visit us on the Web:  
[PORTABLETOILET.NET](http://PORTABLETOILET.NET)

Contact your area sales manager at:  
**(800) 352-1986**



**SYNERGY WORLD**



www.masportpump.com www.masportpumperscent.com

# We're Gonna' *Pump You Up!*

**Come see us in  
Louisville booth 8115!**

**HXL4V**



**Booth 8115**

**HXL400WV**



**#1 Choice for Portable Toilets  
156 CFM @ 0" Hg  
20" Hg Continuous**

**#1 Choice for Septic and Grease  
400 CFM @ 0" Hg  
25" Hg Continuous**

## **Robuschi RB-DV 65 HiVac Blower**

**27" Hg Continuous Vacuum  
900 CFM @ 0" Hg**

**No Oily Mess & No Smoke**

**System pictured was built by:  
Progress Tank**



To Contact a Masport Authorized Distributor  
or to Receive Additional Information

**Call 1-800-228-4510**

# **Masport<sup>®</sup>**





Restroom Dropped On Site

**NEW PORTABLE, COMMERCIAL QUALITY RESTROOMS**



Interior/Restroom Stalls Interior/Utility Sink Storage Tanks

- Heat & AC
- Lighting
- Rubber or Rhino Lined Flooring
- Electrical Outlets
- Hot Water Heater
- Utility Sinks
- Urinals & Stalls
- Self Contained 1500 gal Fresh Water Tank/1500 gal Sewage Tank
- Or Hook Up Directly to Existing Utilities
- Level Indicator Alarm

**PROFIT GENERATION**  
 \$ Monthly Rental  
 \$ Bulk Pumping  
 \$ Potable Water Hauling

**POTENTIAL CUSTOMERS**  
 • Special Events  
 • Industrial/Construction Sites  
 • Community Functions



**1.888.388.7768**  
[www.dropboxinc.com](http://www.dropboxinc.com)

# Tell 'Em

**“I’m Pre-Approved”  
 on Financing**

*New or Used...*

< **Show Special:** Documentation fees waived for pre-approved customers >

Community Leasing Associates, LLC

**1-877-459-5770**

[www.clalease.com](http://www.clalease.com)



Good People - Great Rates



**Gallup** **AGITATOR SYSTEMS INC.**  
 BROOKS, AB

**Vac Trucks, Trailers, Tank Bottoms**

**Tel: (403) 793-4862**

• Specially Designed To Eliminate • Maximum Versatility  
 Hydraulic Oil Contamination Centrifugal Pump System



**Booth 16016-17017**

- The revolutionary new system that will save you time and money
- With high quality and optimum performance the possibility of versatility is unmatched.
- The Gallup Agitation System is designed for the removal of solid waste materials
- Get the Gallup Advantage Agitation System today.

# Lenzyme

*Quality Sells ~ Sell the Best*

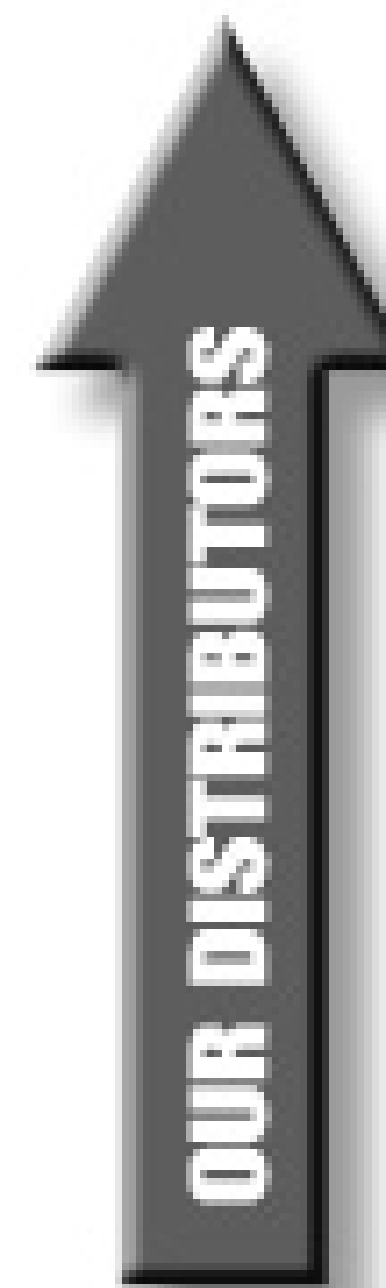

Discover the **SECRET**



to **MORE PUMPOUTS** even in this Down Market

**Products to BEAT all Competitors Pricing!**



Call Today for Your **FREE** Sample

**Booth 6151**

**1-800-223-3083**

920-436-8266 • Lenzyme, Inc.

The **5** Enzyme – Bacteria Grease and Waste Digestant

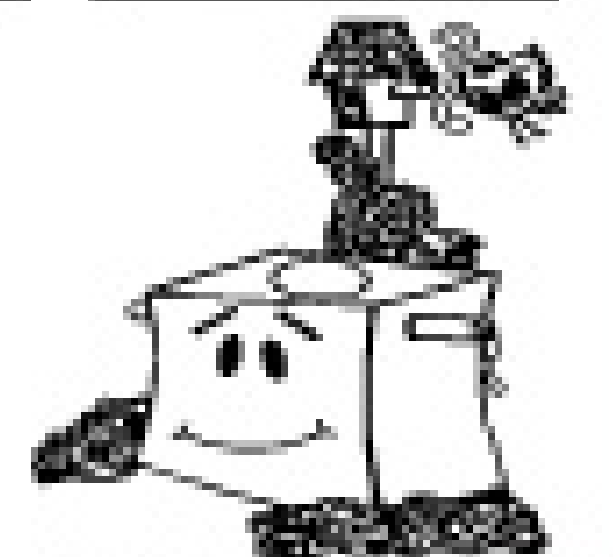



WORLDWIDE EXPORTERS

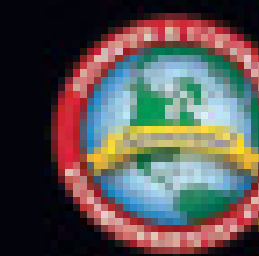

Booth 7015, 7016, 7019, 7021, 7025

# 27th TRUCKS INC.

8975 N.W. 27TH AVE. | MIAMI, FL 33147

PH: 305.835.9030 | EMAIL: INFO@27TH-TRUCKS.COM

**1 Year Warranty on Engines**

**Contact Alan @ 786-512-5597 or Armando @ 786-267-3026**



**2001 MACK VISION CX613**  
4000 Gallon With Dumping System, Jurop Pump LC420  
**READY FOR IMMEDIATE DELIVERY!**



**2003 PETERBILT C12**  
Cat 10 Spd., 430 Hp,  
3600 Gallon Carbon Steel Tank



**2000 PETERBILT C12**  
Cat 430 HP, 3600 Gallon Progress Aluminum Tank  
Fruitland Pump RCF 500, 350 C.F.M.  
**(IN PRODUCTION)**



**2001 STERLING AT9522**  
4000 Gallon Carbon Steel Tank, (Your Choice Of Pump)  
**IN PRODUCTION!**



**1999 PETERBILT C12**  
Cat, 10 Spd., 430 HP, 3600 Gallon Carbon Steel Tank,  
**(IN PRODUCTION).**



**2003 MACK**  
10 Spd., Jake Brake, 570K,  
4000 Gallon Carbon Steel Tank, Jurop Pump LC420.



**2001 MACK**  
10 Spd., 330 HP,  
3600 Gallon Carbon Steel Tank  
**(IN PRODUCTION)**

**5 year Factory Warranty on Carbon Steel Tanks**



**2002 MACK**  
4500 Gallon Aluminum Tank (In Production)

**Special Fleet Maintenance Trucks In Production Ready for Delivery**

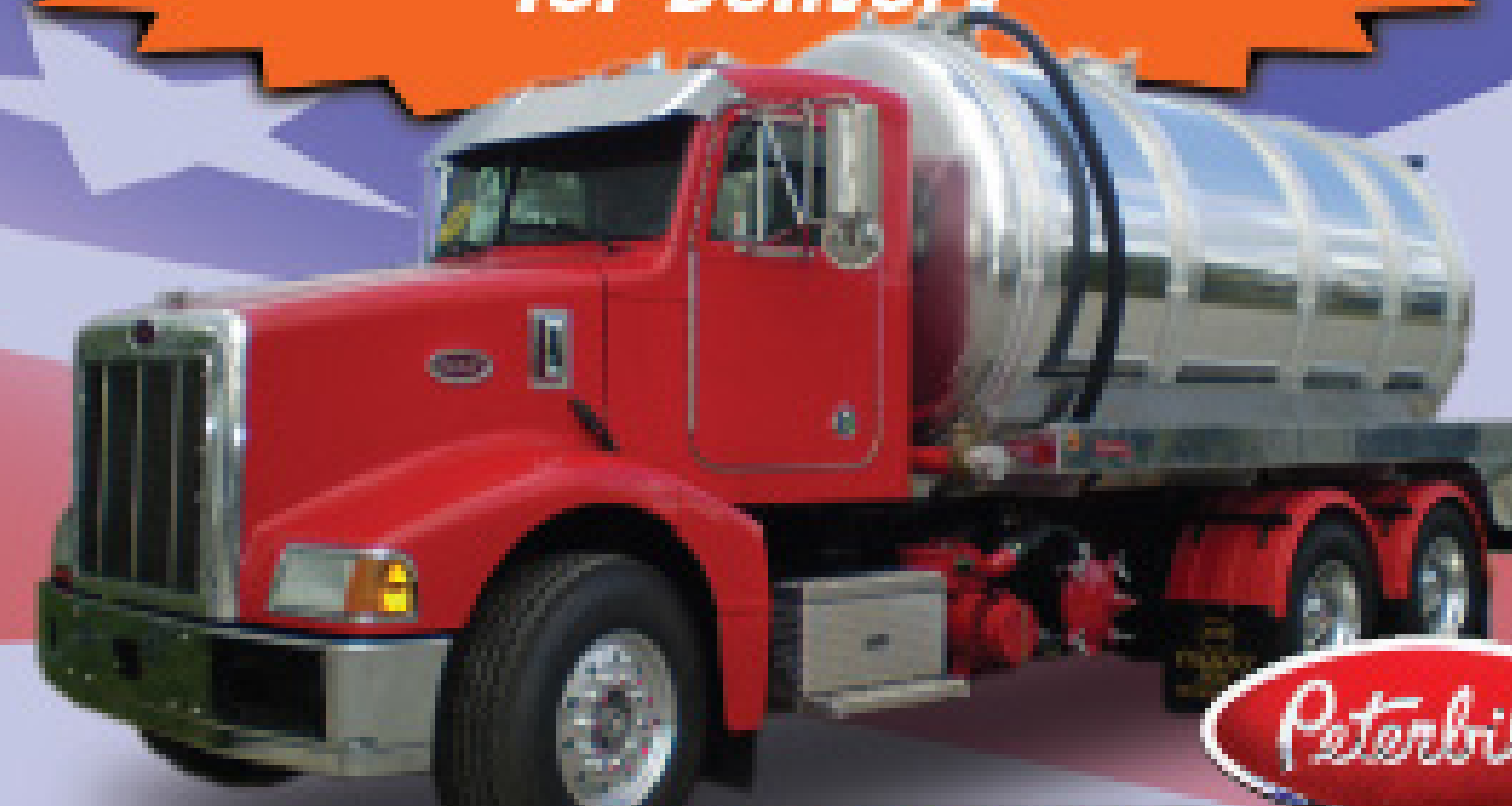

**2000 PETERBILT C12** Cat, New 4000 Gallon Aluminum Tank, Fruitland Pump RCF 500, 350 C.F.M., Custom Build. Ready for Immediate Delivery! Beautiful Truck!



**THANK YOU**  
Mr. Bob From Snyder Septic For Your 3rd Purchase.

**2 Year Factory Warranty on Pumps**

**10 Year Factory Warranty on Aluminum Tanks**



**THANK YOU**  
Gabriel From EPS



**THANK YOU**  
Mr. Ric From Septic Solution



**THANK YOU**  
Croy from the Virgin Islands



**SOLD**  
to Aruba

**WWW.27TH-TRUCKS.NET**

**FINANCING NOW AVAILABLE FROM CAPITAL PARTNERS**





## ARTICLES

**36**  
**Spreading the Word**  
- Scottie Dayton

**On the cover:** Alpena Septic Service has added a 100,000-gallon septage storage tank, enabling the company to continue an economically efficient land application program. Owner Richard Gillespie is shown making adjustments to the storage system. (Cover photo by Amy Lisenbe)

**10**  
**Reading Between the Lines: Be Safe Out There**

Include safety in your list of goals for a busy 2008 season.  
- Jim Kneiszel

**18**  
**Building the Business: Failure Often Leads to Success**

If you're afraid to stumble and fall with a business initiative, you may never reach your full potential.  
- Gary Bradt

**26**  
**Rules and Regs: Texas Relaxes Onsite Rules**  
- Scottie Dayton

**48**  
**Pumper Interview: A Suction Scare**

"I don't care how strong you are, once a vacuum hose seals on you, you're not going to pry it off."  
- Scottie Dayton

**70**  
**On the Road Again**  
East Texas pumper LASSO kicks up some dust and wears through a lot of tires serving customers in an expansive territory.  
- Richard Ryman

**80**  
**Overheard Online: At the Car Wash**  
An expansion-minded pumper wonders about the challenge of disposing waste from self-service car washes.

**88**  
**Lighter Side: Life of the Party**  
Portable restroom Halloween costume is a big hit on the streets of New York.  
- Jim Kneiszel

## 2008 EXPO

**58**  
**It's All Here!**  
Exhibitors provide hands-on look at industry's latest technology.  
- Ed Wodalski

## REGULAR FEATURES

**96**  
**Money Manager: Be It Resolved ...**  
Here are 10 ideas to increase your odds of achieving personal and financial success in 2008.  
- Erik Gunn

**104**  
**Reader Pipelines: 'I've Driven Four Trucks Home'**  
Attendees say the Pumper & Cleaner Expo feeds equipment needs and gives them a leg up on the competition back home.  
- Mary Shafer

**112**  
**Septic System Answer Man: Basic Training**  
A new inspector asks for a step-by-step approach to working with the industry to encourage the most effective onsite systems for homeowners.  
- Roger E. Machmeier, Ph.D

**120**  
**Industry News**

**124**  
**Classy Truck of the Month**  
We feature Enviro Waste Oil Recovery of Mahopac, N.Y.

**134**  
**NAWT News: See You in Louisville**  
Association is bringing big opportunities in education and certification.  
- Tom Ferrero

**152**  
**Association News; Training and Education; Calendar**

## Coming in February

Special Issue: Pumper & Cleaner Environmental Expo Show Issue

- **Classy Truck of the Year:** Introducing the top truck from 2007
- **Contractor Profile:** Oregon couple lives their pumping dreams

# Pumper

DEDICATED TO THE LIQUID WASTE INDUSTRY

[www.pumper.com](http://www.pumper.com)

Published monthly by  
**COLE Publishing Inc.**  
1720 Maple Lake Dam Rd.  
PO Box 220  
Three Lakes WI 54562

© Copyright 2008 COLE Publishing Inc.  
No part may be reproduced without permission of the publisher

In U.S. or Canada call toll-free 800-257-7222  
Elsewhere call 715-546-3346  
E-mail: [info@pumper.com](mailto:info@pumper.com)  
Web site: <http://www.pumper.com>  
Fax: 715-546-3786

Office hours 7:30 a.m. - 5:00 p.m.  
Central Time, Monday - Friday

**SUBSCRIPTION INFORMATION:** A one year (12 issue) subscription to Pumper in the contiguous 48 U.S. states costs \$16 (24 issues for \$26; 36 issues for \$36). Subscriptions to Canada or Mexico cost \$28 per year (24 issues for \$54). Subscriptions to all other foreign countries cost \$82 per year. Subscribers are guaranteed monthly delivery of the magazine. To subscribe, send company name, mailing address, phone number and check or money order (U.S. funds payable to COLE Publishing Inc.) to the address above. MasterCard, VISA and Discover are also accepted. Supply credit card information with your subscription order.

**CLASSIFIED ADVERTISING: RATE:** \$1.00 per word, per month. Minimum of 20 words or \$20. All classified advertising must be PAID IN ADVANCE. **DEADLINE:** Classifieds must be received by the first of the month for insertion in the next month's edition. **PHONE-IN ADS ARE NOT ACCEPTED.** Ads may be faxed only when charging to MasterCard, VISA or Discover. Please supply all credit card information with faxed ads. Be sure to include your phone number (with area code) in your ad. Make checks payable to COLE Publishing Inc. and mail with classified ad to the address above. **CLASSIFIED ADVERTISING APPEARS NATIONWIDE AND ON THE INTERNET.** Not responsible for errors beyond first insertion.

**DISPLAY ADVERTISING:** Call 800-994-7990 and ask for Jeff, Jim, Kim or Winnie. Publisher reserves the right to reject advertising, which in its opinion is misleading, unfair or incompatible with the character of the publication.

**CIRCULATION:** Circulation averages 24,493 copies per month. This figure includes all three circulation regions (nationwide) and international distribution.

## 2008 PUMPER & CLEANER ENVIRONMENTAL EXPO INTERNATIONAL



Education Day:  
February 27, 2008

Exhibits Open:  
February 28, 29,  
March 1, 2008

Kentucky Exposition Center  
Louisville, Kentucky

[www.pumpershow.com](http://www.pumpershow.com)





# moroPUMPS

"Over 50 years of service and here to stay!"

Ask for a quality Moro pump from your truck builder, or call us for the dealer nearest you.

Pittsburgh, PA . 1-800-383-6304 . fax 412-269-4172 . www.morousaeast.com . moroeast@attglobal.net  
St. Louis, MO . 1-866-383-6304, 636.584.8844 . fax 636-583-2044 . www.morousaeast.com . moro@charter.net

## Isn't it time to UPGRADE to a MORO?

Stop by and see us at the Louisville Show!



Booth 6097

### Complete Right Angle Packages

Completely Assembled

**M3**  
176 cfm



Pumps available from 176-1642 cfm

**M10**  
230 cfm



**PM80** 350 cfm

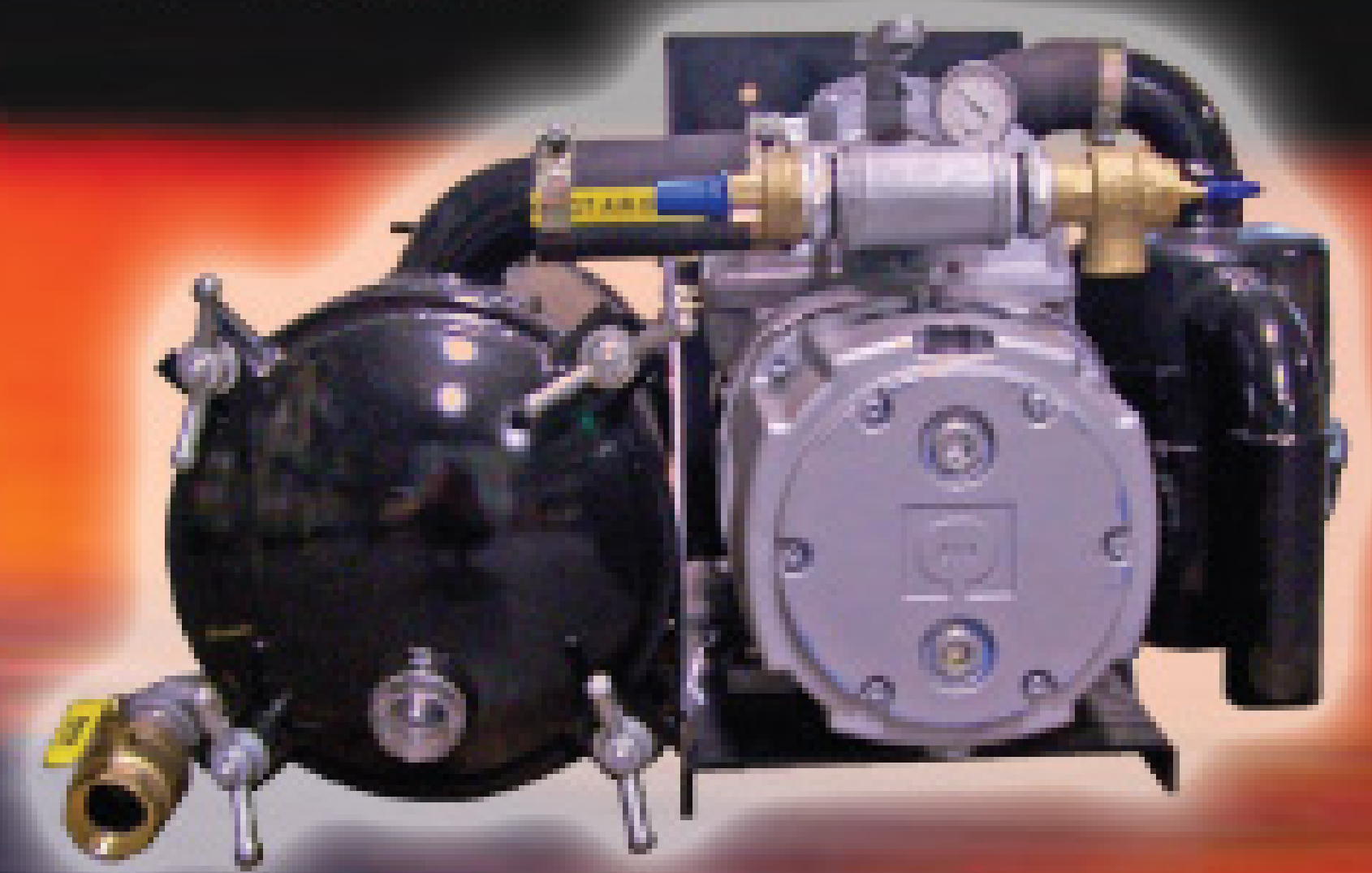

**PM100**  
460 cfm



RIGHT ANGLE, HYDRAULIC,  
GAS OR DIESEL PKGS.  
AVAILABLE  
ON ALL PUMPS

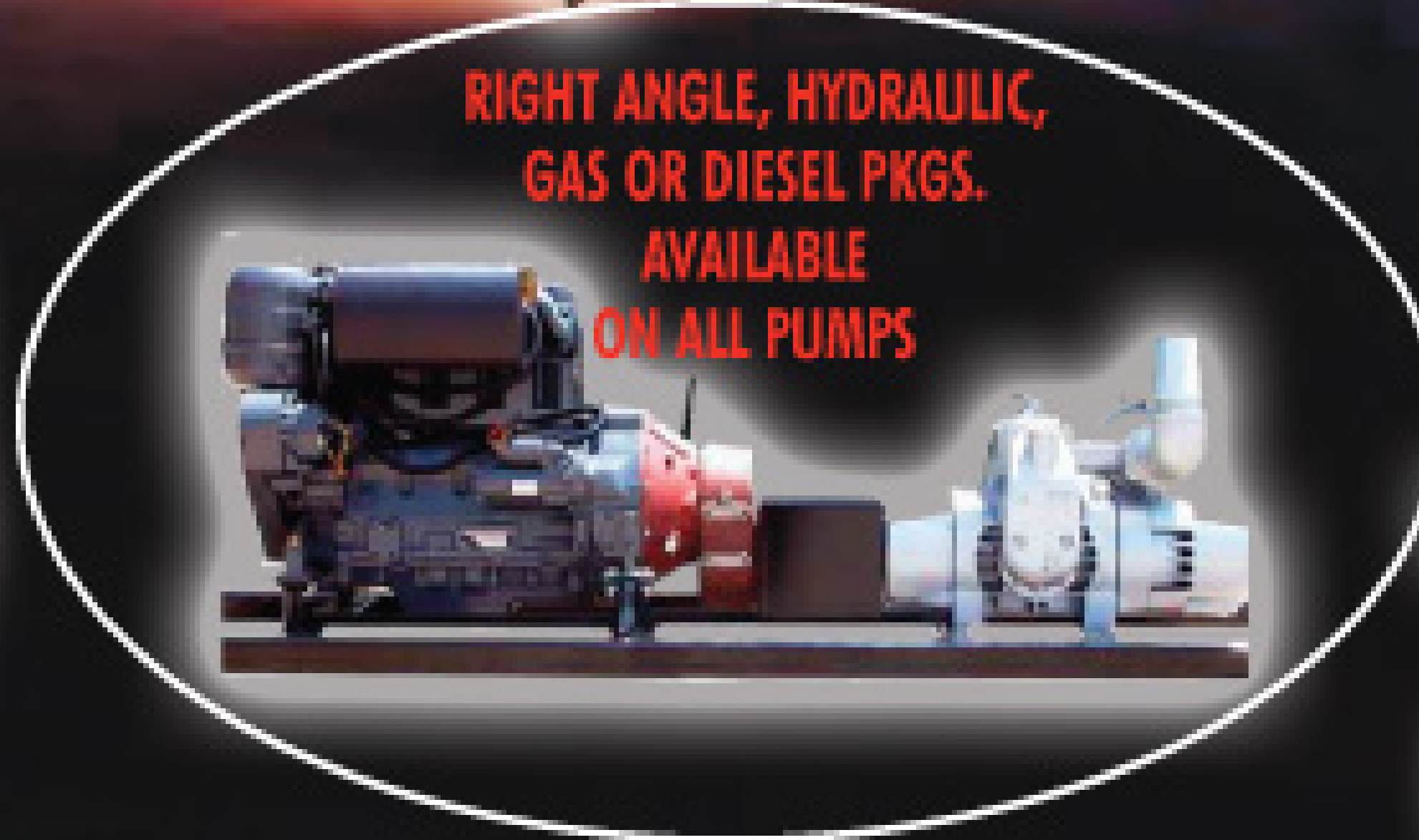

**PM2600** 824 cfm

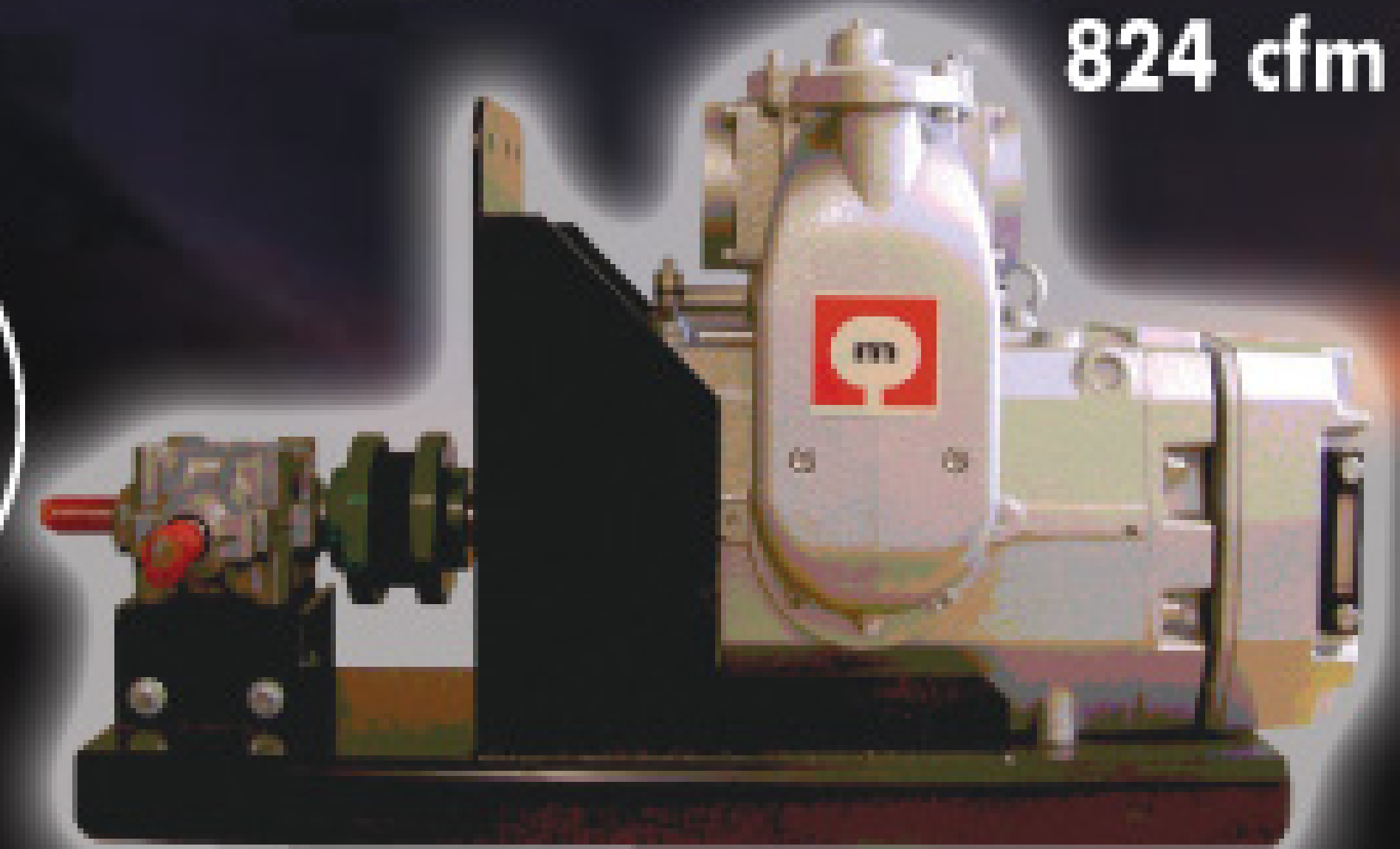

### DC-STAINLESS Washdown Pump

**NO COMPARISON**

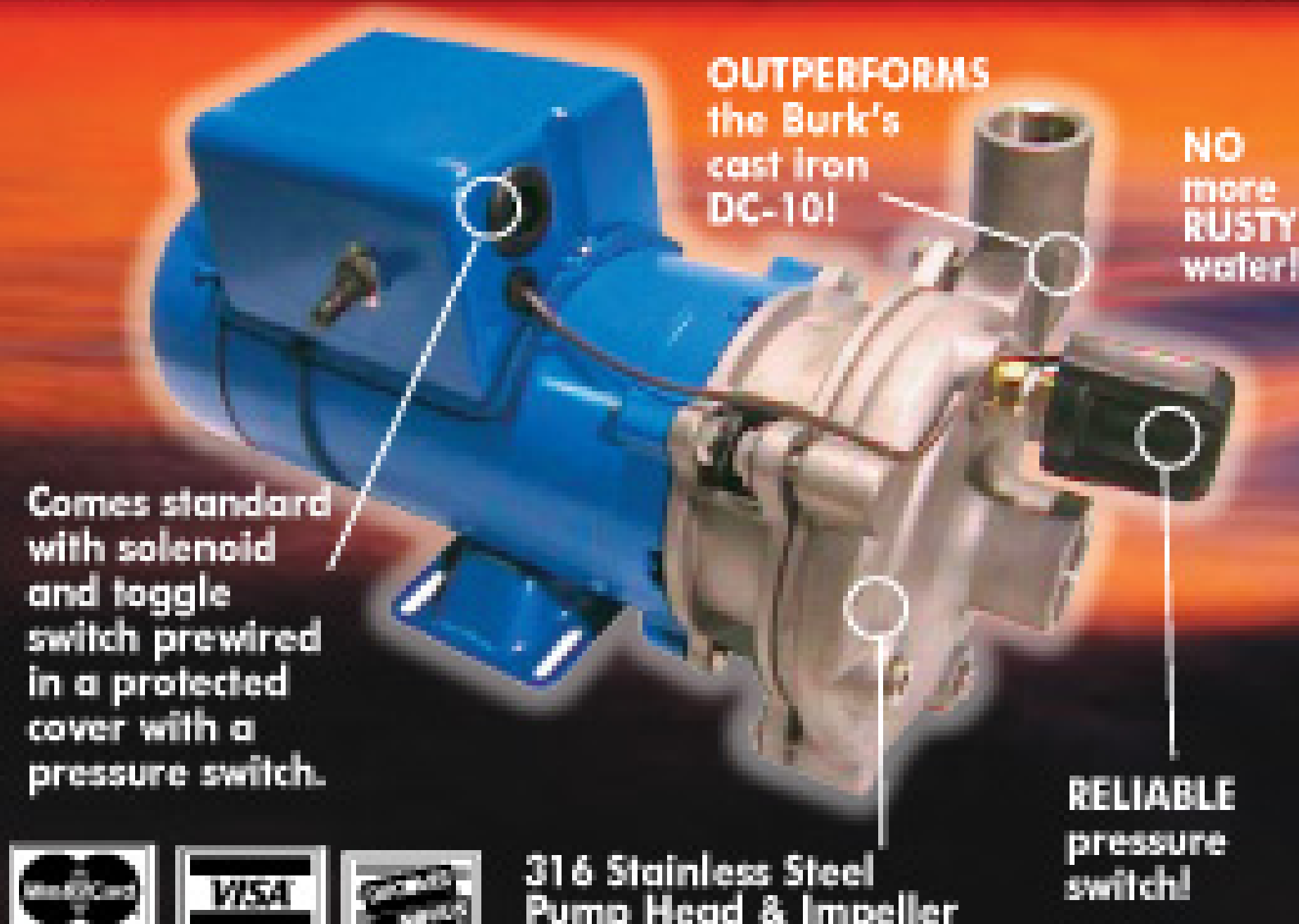

OUTPERFORMS the Burk's cast iron DC-101

NO more RUSTY water!

Comes standard with solenoid and toggle switch prewired in a protected cover with a pressure switch.

RELIABLE pressure switch!



316 Stainless Steel Pump Head & Impeller

### Quality RIV Components In Stock — Ready for Shipment



### ACCU-LEVEL Accurate Tank Volume Measurement

No Balls • No Tubes • No Floats • No Worry!  
No Internal Tank Components

Get paid for what you pump!

Only pay for what you dump!



Level Indicator

Factory calibrated, the general purpose indicator reads 0-100% of volume in gallons. A single push button allows users to scroll through their active channels.



Pick-up Unit

The general purpose two-wire transmitter provides non-contact level measurement up to 32' and is ideally suited for challenging corrosive, coating or waste liquids.

# ADVERTISER index ....

27th Trucks, Inc. ....5

## A

A & L Systems Inc. ....34  
A Corp/Rooter-Man .....14



Abbott Rubber Co., Inc. ....122  
Abernethy Welding & Repair 121  
Accent Manufacturing .....128  
ACG Equipment Finance.....154  
Acro Trailer Company.....16  
Advance Pump & Equip. ....19  
Advanced Containment Sys...78  
Advanced Tank Systems.....20  
Alpha Mobile Solutions .....20  
Ameri-Can Engineering .....108  
American Industrial .....120  
American Machine & Tool Co. 54  
Amigo Truck Ltd. ....90  
Amthor International .....98  
Aqua Ben Corp. ....67



Aqua-Zyme Disposal Sys. ....30  
Aquaworx .....35



Arcan Enterprises Inc. ....106



ARMAL Inc. ....11-13



Armstrong Equipment ..24, 122  
Art's Truck & Equipment .....86  
Atlanta Rubber & Hyd. ....160

## B

B & W Mantrad Inc. ....24  
Badger Truck Center.....68



Bandlock Corp. ....31  
BASE Engineering Inc. ....140  
BDP Industries Inc. ....45  
B. E. Enterprises.....34  
Best Enterprises, Inc. ....93  
Black Tie Mfg. Inc. ....29  
Brenlin Co. Inc./Seal-R.....90



Bright Technologies .....24

## C

Cadman Power Equipment. 148



Cam Spray .....90  
Cape Cod Biochemical .....53  
Capital Partners LLC .....68



Capital Rubber Corp. ....84

## C

Center Capital Corp. ....55



Chandler Equipment Inc. ....9  
Chempace Corporation.....77  
Circle D Truck Sales .....49



Clear Computing Inc. ....44  
Cloverleaf Tool .....140  
Com Vac Systems .....44



Comforts of Home .....124  
Community Leasing .....4



Crust Busters/Schmitz Bros. 86

## D

Del Vel Chemical Co. ....68  
Denver Truck Sales.....54  
Dragon Products.....40-41  
Drop Box Inc. ....4  
Dunham & Morrow Inc. ....86

## E

Ecological Laboratories .....159



Elastec/American Marine .....32  
Engine & Accessory Inc. ....81  
Eventrestrooms.com .....90  
Excel Equip. & Supply .....33  
Explorer Trailers - McKee ....160

## F



F. S. Solutions .....128  
Fergus Power Products .....148  
Five Peaks Technology .....125



Flo Trend Systems Inc. ....98



FMI Truck Sales & Service ..113  
Frontier Technology .....76  
Fruitland Tool & Mfg. ....126

## G

Gallup Agitator Systems.....4  
GapVax Inc. ....91  
General Pump .....110  
Global Vacuum Sys. Inc. ....95  
GO FOR DIGGER .....76  
Granite Leasing Co. ....43  
Great Lakes Equip. Inc. ....123  
Green Leaf Inc. ....34

## H

H&M Vac Pumps & Equip. ....52  
Hampel Corp. ....22-23, 97  
Hannay Reels .....138  
Hedstrom Plastics .....160  
House of Imports .....133

## I

IHI Compact Excavators .....146  
Imperial Industries Inc. ....161

## J



J&J Chemical Co. ....131  
Jack Doheny .....25  
J. C. Gury Company Inc. ....56



Jag Mobile Solutions .....14, 54

## K

KeeVac Industries Inc. ....99  
Keith Huber Inc. ....127  
Kentucky Tank Inc. ....132  
Key Commercial Corp. ....120  
Kuriyama of America Inc. ....94

## L

L.C. Tanks.....111  
L.M.T. Inc. ....16  
Labrie Environ. Group .....158  
Lane's Vacuum Tank Inc. ....105

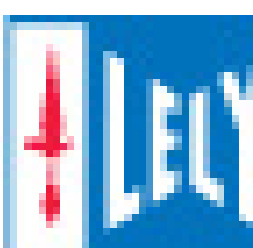

Lely Manufacturing Inc. ....109



Lenzyme/Trap-Cleer Inc. ....4  
Liberty Financial Group .....114  
Longhorn Tank & Trailer Inc. ....56

## M



Marsh Industrial .....52



Masport Inc. ....3  
Michigan Vacuum Truck Inc. 30  
Mid-Continent Truck Sales ..141  
Mid-State Tank .....14  
Milwaukee Rubber Prod. ....118

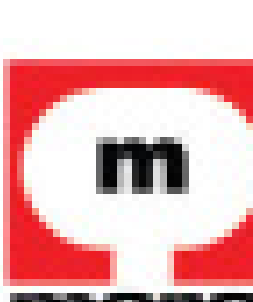

Moro USA East Inc. ....7  
Mytana Mfg. Co. Inc. ....108

## N

National Truck Center .....103  
National Vac. Equip. Inc. ....115  
Nilodor, Inc. ....42



NuConcepts .....52

## O

Overland Tank Inc. ....135

## P

Pat's Pump .....14  
Peterbilt of Greenville .....20



Pik Rite, Inc. ....74  
PolyJohn Enterprises .....163  
Polylok Inc. ....162  
PolyPortables Inc. ....17, 27  
PolyPortables Inc./Green Way ..57  
PowerFlo Products Inc. ....78  
Precision Tank & Equip. ....138

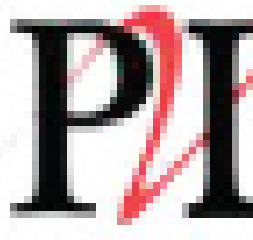

Pressure Lift Corp. ....92  
Presvac Systems Ltd. ....164

## P

Prime Solution Inc. ....56  
Prometheus Partners .....75



Prototek .....154

## R



RABCO .....158  
Ratech Electronics Limited ..102  
Reelcraft Industries Inc. ....114

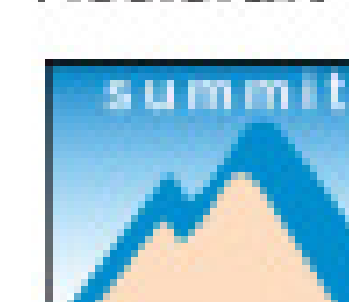

Ritam Technologies .....67  
Robinson Septic Service .....94  
Robuschi & C.S.p.A. ....51  
Rocket Supply Corp. ....138  
RotoSolutions Inc. ....118  
RouteOptix Inc. ....110  
Rush Refuse Systems .....139

## S

Satellite Industries 15, 82-83, 129

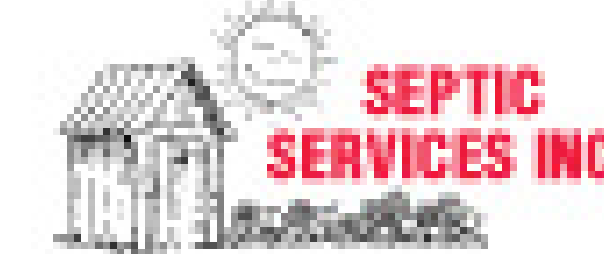

Septic Services Inc. ....92  
Sludge Management .....116  
Smithco Mfg. Inc. ....74  
Specialty B Sales .....126  
SPG Tanks Inc. ....100  
Stellar Industries Inc. ....106  
Stuart Tank .....42  
Super Products LLC .....136  
Superior Signal Co. Inc. ....94  
Surco .....21  
SVE Sales Inc. ....110  
Sweet Septic Systems Inc. ....106  
Synergy World Inc. ....2

## T

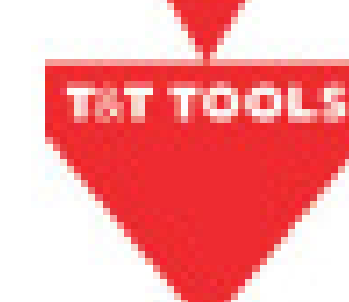

T&T Tools Inc. ....105  
Tank Truck Service & Sales ..67



TankTec .....46-47  
TCF Equipment Finance .....147



The Service Program .....26



Toico Industries Inc. ....50



Transport Truck Sales.....137



Transway Systems Inc. ....87  
Truck Town Inc. ....154  
Trucks At Hand .....76  
TSF Company Inc. ....101  
TST, LLC .....118  
Tuf-Tite Inc. ....89

## U

U.E.M.S.I. ....32

## V

Vac-Con, Inc. ....117  
Vacutrix Limited .....136



Vacuum Sales Inc. ....148



VAR Co. ....132

## W

Walex Products Co. ....119  
Wallenstein Pumps-  
Elmira Machine.....116  
Wastequip Cusco Inc. ....85  
Water Cannon.....84  
Wee Engineer Inc. ....79



Wells Cargo COG .....100  
West-Mark Inc. ....107  
Westmoor Ltd. ....69, 102  
White River .....128  
Wilcox Truck Sales .....116  
Wolf Creek Co., Inc. ....136

**Classifieds .....142**  
**Marketplace .....149**  
**Truck Stop .....155**

## REGIONAL ADVERTISERS

### Western Supplement

(after page 130)

Armstrong Equipment .....3  
Custom Tank & Equip. ....4  
Erickson Tank & Pump .....1  
Glendale Welding .....4  
James Wilbee Company. ....8  
Southern CA Tank & Fab .....2

### Midwest Supplement

(after page 130)

Allied Tank .....5  
Bosserman Tank & Truck .....4  
Engle Fabrication Inc. ....4  
Marengo Fabricated .....7  
Mid-State Truck Service .....6  
Milwaukee Rubber .....2  
Pierson Co. ....2  
Rider Vacuum Sales .....3  
Southcoast Equipment .....8  
T-Line Equipment Inc. ....1  
V&H Inc. ....6

### Eastern Supplement

(after page 130)

Allied Tank .....5  
Anderd .....6  
Apple's Welding & Machine ....4  
Bay State Truck .....1  
Bosserman Tank & Truck .....4  
Cellofoam .....2  
Manchester Hose .....2  
Marengo Fabricated .....7  
Southcoast Equipment .....8  
Vacuum Sales Inc. ....3  
V&H Inc. ....6



# JUROP R260

now available with a  
**JUROP Aluminum Final Filter**

The **R260 VACUUM PUMP** combined with **JUROP Final Filter** protection makes for longer pump life.

**WORKHORSE PERFORMANCE**



- LIGHT WEIGHT
- REUSABLE STAINLESS STEEL 55 MESH FILTER ELEMENT
- EASY CLEAN OUT

**Final Filter Protection**

- JUROP R260 VACUUM PUMP**
- 363 CFM
  - BUILT-IN OIL RESERVOIR
  - 18" CONTINUOUS DUTY
  - AUTOMATIC OILING

Visit us in LOUISVILLE  
Feb. 28-29 & March 01  
2008

**BOOTH 8099**



Call 800-342-0887 for a dealer near you  
[www.chandlerequipment.com](http://www.chandlerequipment.com)

# PVT200

# 795 CFM

# TRI-LOBE HI-VAC BLOWER

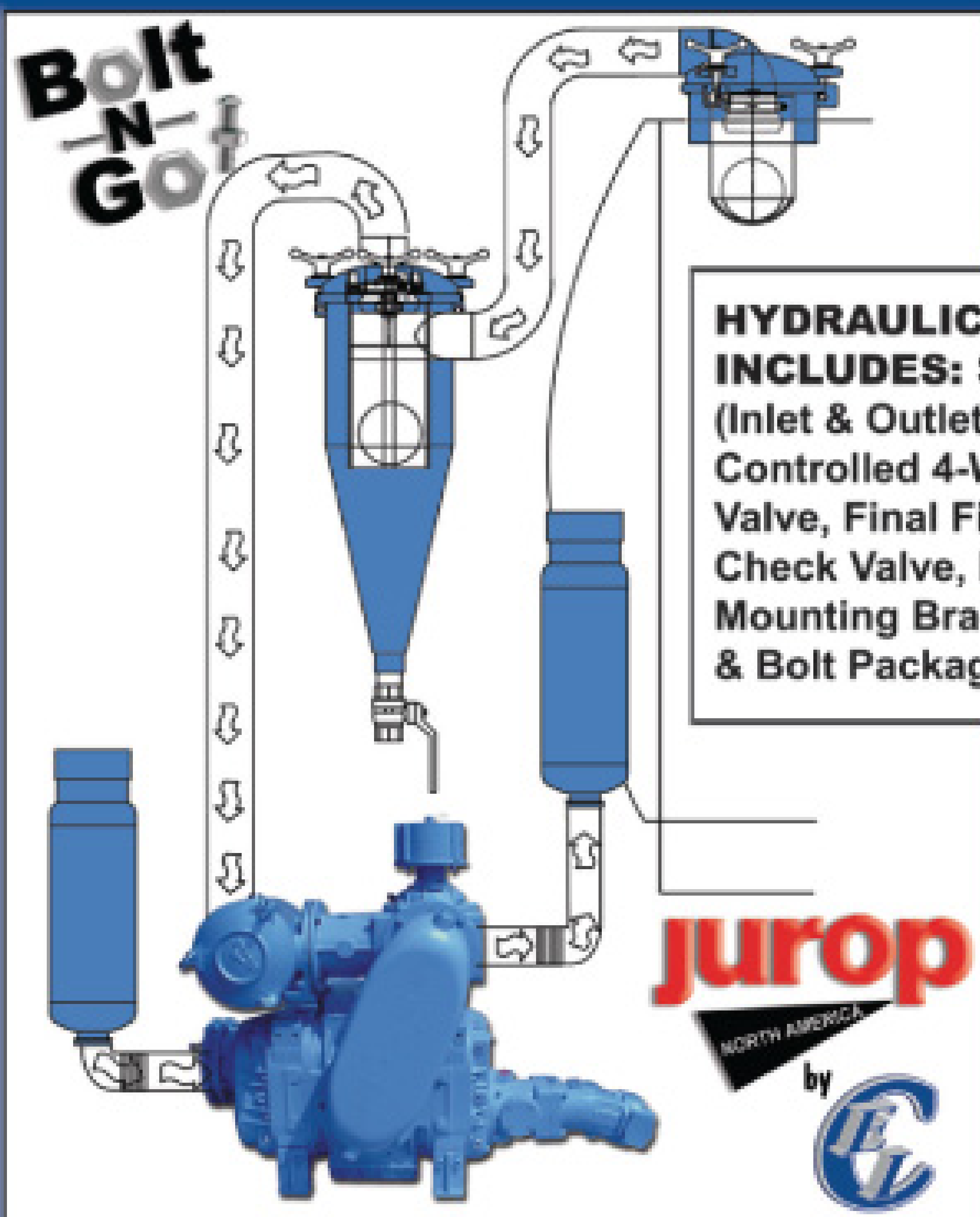

**HYDRAULIC DRIVE:**  
**INCLUDES:** SUCTION GROUP (Inlet & Outlet Silencers, Air Controlled 4-Way Change Over Valve, Final Filter, Non-Return Check Valve, Hydraulic Motor, Mounting Bracket, Flanges & Bolt Package)

**COMPLETE PACKAGE**

**27" CONTINUOUS DUTY**

**JURO-FLO**

The **JUROP PVT200 TRI-LOBE BLOWER** is designed to deliver a high level of performance without the hassle of maintenance. It is rated at 795 CFM and is cooled by air injection.

The **PVT200 Series Blower** is a positive displacement rotary lobe pump with profiled and synchronized lobes made in high quality cast iron.

The **PVT Series Blowers** are oil free and environmentally safe. No lubrication oil is needed within the pumping chamber since the pump works without friction and consequently there is no oil delivered to the atmosphere.

**EASY INSTALLATION!**

Call 800-342-0887 for a dealer near you  
[www.chandlerequipment.com](http://www.chandlerequipment.com)



# Be Safe Out There

By Jim Kneiszel, Editor

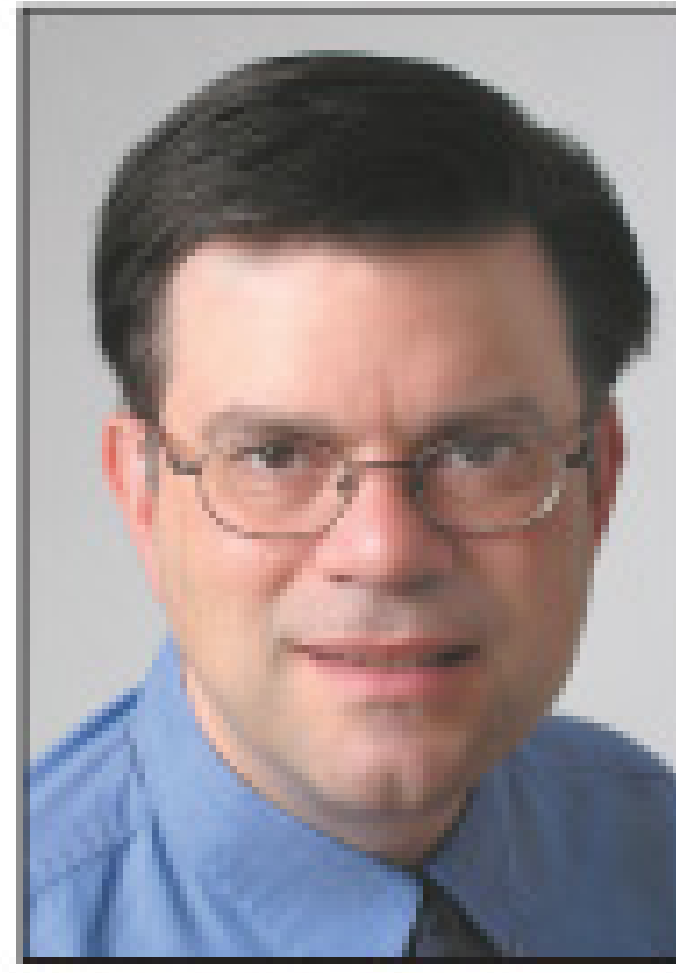

Your list of New Year's resolutions might include losing a few pounds, taking a dream vacation or reading a book a week. While these resolutions might change from year to year, there's one goal you should set every January and work to attain throughout the year: improve safety at work.

Every year we hear about a handful of horrifying industrial accidents that either seriously injure or kill someone working in one of our related fields. Your response to those chilling stories may be: "But for the grace of God, that could be me."

Late last fall, another one of those tales surfaced in northern Wisconsin. One of the owners of a landfill descended into a pit where accumulated drainage entered the sewer system. He was planning to fix a malfunctioning pump. The worker's brother looked down and noticed he was gasping for breath, so he followed him through the manhole. Two more men followed into the pit and all four were overcome by hydrogen sulfide fumes and died.

Where was the awareness of confined space rules? How could several men working at the landfill not be aware of the potential danger of this situation? If they had received ample safety training, proper equipment and constant reminders of dangers at the workplace, they'd have had a better chance of being around for their families today.

Some of the larger waste-pumping companies employ a safety manager who is responsible for regular training including confined space procedures to be followed. Smaller companies often hold daily tailgate safety sessions before going to a jobsite. Other companies send their workers to regional training sessions sponsored by a state or national trade association.

Whatever path you take, please make it a point to continually address safety at work during 2008. If the greater awareness of dangers of the job prevents even one of these terrible incidents this year, the effort will be worthwhile.

### DANGERS OF EXTREME SUCTION

The *Pumper Interview* story this month illustrates the importance of working safely. In it, Tom Lewis, the owner of Resource Geoscience Inc. in Colorado, explains what happened the day his arm was sucked into a whip hose while he was vacuum loading debris on the roof of a car wash.

His vision obscured by perspiration on his face shield, Lewis' hand got too close to the end of the hose that was pulling 3,700 cfm of pressure, and the hose pulled off a glove. Instinctively, he reached for the glove and the hose quickly covered his arm.

"I calculated the force exerted on my arm to be about 300 pounds," Lewis told writer Scottie Dayton. "I don't care how strong you are, once a vacuum hose seals on you, you're not going to pry it off."

Luckily, Lewis had conducted a safety review before the job that day and had a spotter standing beside him to signal another worker to relieve the vacuum at the truck. Lewis was hurt, but he recovered. Now he generously shares some advice about safety with *Pumper* readers. ■

**Contact us:** *Pumper strives to serve the liquid waste industry with interesting and helpful stories. We welcome your comments, questions and column suggestions and promise a prompt reply to all reader contacts. Call 800/257-7222; fax 715/546-3786; e-mail Pumper editor Jim Kneiszel at editor@pumper.com.*

## Letter to the Editor

### Writer Elaborates on Community Collection Systems

Dear Editor:

In the April 2007 issue of *Pumper*, editor Jim Kneiszel wrote about a tragedy in Montana where a 3-year-old boy fell through a broken septic tank lid riser and perished. In the article, the author raised a question that must be answered. He describes the fact that the particular septic tank in which the boy perished was part of a community system in which septic tanks were installed, or left in place, at homes that were part of a community collection system. He then raised the question: "Why does a public utility connect homes to a sewer line, but allow septic systems to remain in the pipeline?" Actually, they did not leave "septic systems," only septic tanks. This statement appears to indicate a need for information on the many benefits of effluent collection systems.

Effluent collection systems are systems where septic tanks are used at each connection but the effluent is conveyed away either by pumps (STEP systems) or by gravity flow (STEG systems). Effluent collection systems have many advantages for a community, particularly for an existing community that currently has septic systems but decides it needs to install a collection system. Having septic tanks at each home or connection has the following advantages:

- All solids are removed and the collection system only needs to be capable of carrying water, greatly simplifying the system.
- Small diameter collection lines (as small as 1 inch and mostly less than 4 inches) that are absolutely water tight can be used instead of minimum 4-inch or 6-inch lines that typically have leaky joints.
- Collection lines do not have to be on any particular grade since they do not have to move solids.
- Costly lift stations and manholes are unnecessary.
- Elimination of manholes and use of water-tight pipes eliminates environmental contamination along the lines and problems created by infiltration and inflow during wet weather.
- Lines can even run uphill for short reaches so long as the general trend is downhill. If all connections have pumps and proper backflow prevention, there are no grade requirements.
- Installation of small diameter lines is much less disruptive to the community and can be installed by directional boring techniques meaning that only a few excavations are needed.
- Over 50 percent of the energy demand for treatment (i.e. the BOD) is left in the septic tanks to digest anaerobically without any energy input, thus greatly reducing the cost for treatment as well as for conveyance.

Usually, as in the case of the article referenced, the septic tanks at each connection are put under the management of the local sewer authority so that the authority can be sure that they are properly maintained. Effluent collection systems are widely used in many parts of the country for both existing and new development. This type of system is actually easier and much cheaper to maintain than a conventional gravity collection system. So, in answer to Kneiszel's question, septic tanks are often left at individual homes for very good reasons. Certainly they need to be properly designed, constructed and maintained to be secure so that they do not become a hazard. Perhaps in the case of the Montana community, the problem was not that septic tanks were left at individual homes, but that materials of inadequate strength, durability, and security were used for the lids and risers by the designer and/or the installation contractor.

Ted Loudon, Professor Emeritus, Michigan State University

# Top Line.



LEONES

## Armal introduces the Top Line.

The new portable toilet TOP LINE: more durable, easier to handle and simpler to clean.  
With TOP LINE you get a high quality toilet at an unbeatable price and free delivery.



# Armal

[www.armal.biz](http://www.armal.biz)

Armal Inc. 122 Hudson Industrial Drive, Griffin, GA 30224 - USA  
Phone 770 491 6410 - Fax 770 491 9458 - Toll Free 866 873 7796  
[armal-inc@armal.biz](mailto:armal-inc@armal.biz)



# Scentbox.



LEONES

International Patent Pending  
PCT/IT2007/000700

## Armal introduces the Scentbox.

The first portable toilet with scented wall panels printed with permanent graphics. Sturdy and easy to clean Scentbox is available in 5 fragrances, 5 graphics and 5 new colors.



**Strawberry Field**   **Apple Blossom**   **Pinewood Trail**   **Rose Sensation**   **Vanilla Balm**

# Armal

[www.armal.biz](http://www.armal.biz)

Armal Inc. 122 Hudson Industrial Drive, Griffin, GA 30224 - USA  
Phone 770 491 6410 - Fax 770 491 9458 - Toll Free 866 873 7796  
[armal-inc@armal.biz](mailto:armal-inc@armal.biz)

# Mybox.



LEONES

## Armal introduces Mybox.

Now with MYBOX we permanently customize the wall panels of your toilet with graphics of your choice. Available in a large range of colors.



# Armal

[www.armal.biz](http://www.armal.biz)

Armal Inc. 122 Hudson Industrial Drive, Griffin, GA 30224 - USA  
Phone 770 491 6410 - Fax 770 491 9458 - Toll Free 866 873 7796  
[armal-inc@armal.biz](mailto:armal-inc@armal.biz)



WANTED  
FOR EXCESSIVE QUALITY!



Have you seen this trailer?

Call (800) 815-2557 or  
visit [jagmobilesolutions.com](http://jagmobilesolutions.com)

REWARD!



Booth 7131

Join The Rooter-Man Team  
**WWW.ROOTERMAN.COM**

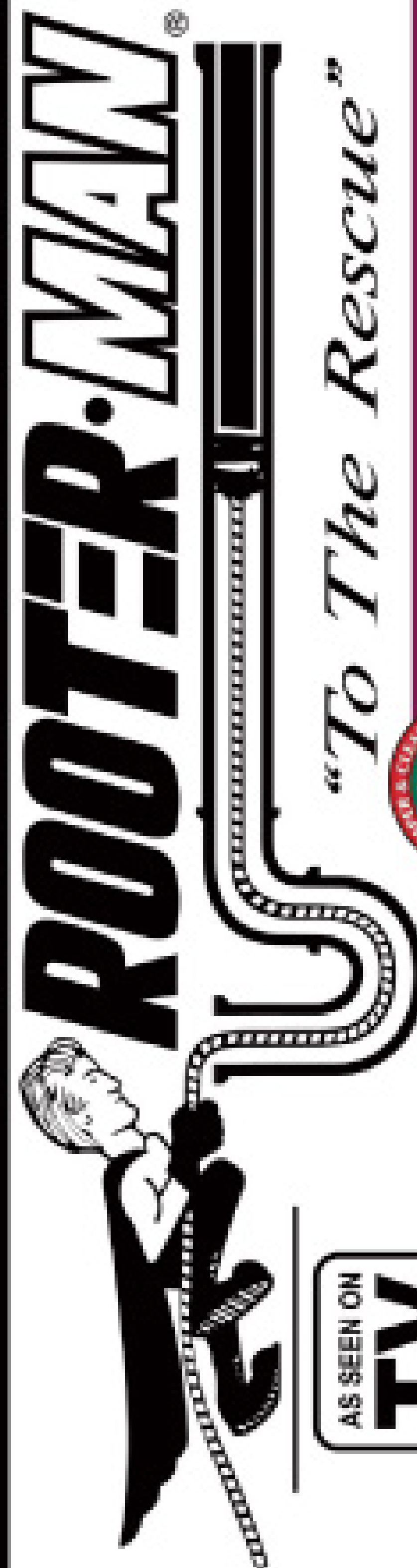

AS SEEN ON  
**TV**

Booth 9115, Truck Space TR-9015



**New Concept In Franchising**

**NO ROYALTY ON PERCENTAGE OF SALES BASED ON POPULATION**

**Exclusive Territories Available**

**Reserve your Territory, Call 1-800-700-8062**

**FRANCHISE PACKAGE \$7,950.**



**PAT'S  
PUMP +  
BLOWER**

ORLANDO OFFICE  
**800-359-7867**  
fax: 407-648-2096  
GEORGIA OFFICE  
**800-851-7987**  
fax: 404-761-7003

Now A  
**Factory Authorized  
Dresser Roots  
Sales & Service Center**



**#1 Pump And Blower  
Repair Specialist**

Blower Repair Exchange Program: Roots, Spencer,  
Robuschi, Hicks Hargraves, Higon, Holmes

CALL FOR PRICING

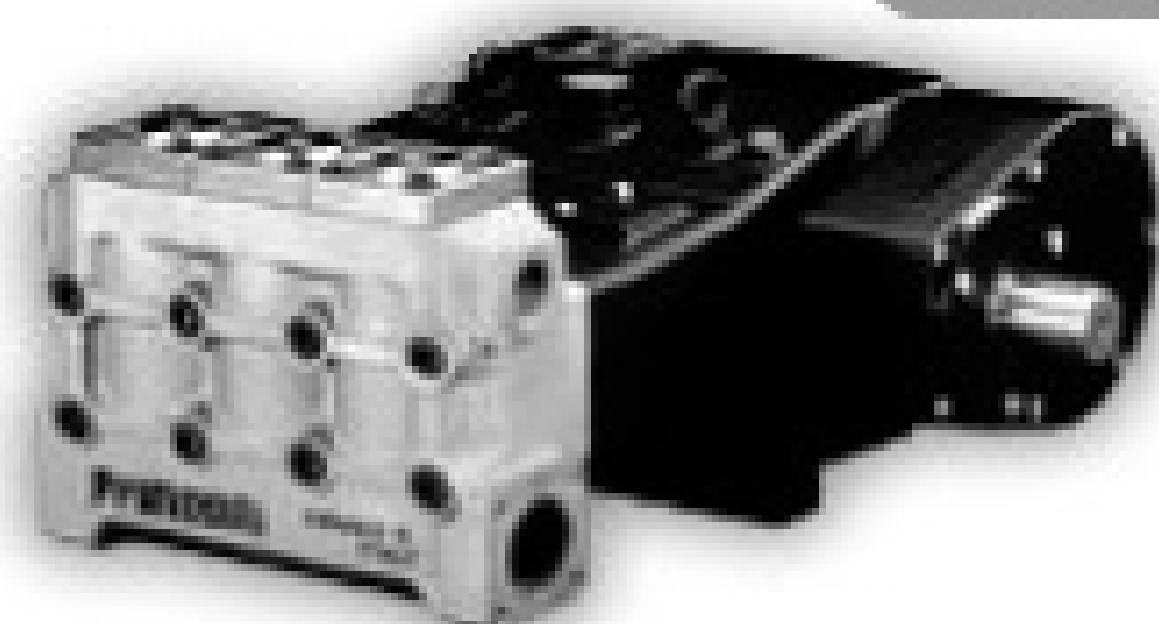

**General Water Pumps**  
From Jet Trailers to combo units  
Retrofit Kits are available!  
5 year warranty

**[www.patspump.com](http://www.patspump.com)**



**Tanks For Your  
Business**

Mid-State Tank manufactures stainless steel and aluminum tanks and has become a well-known and respected supplier for the agricultural, aviation, industrial and fire services, as well as pressure/vacuum tanks.

Mid-State Tank holds an ASME stamp and is D.O.T. approved.



Booth 4000-4001

**Mid-State Tank Co., Inc.**

PO Box 317 • Sullivan, IL 61951  
(800) 722-8384 • Fax: (217) 728-8384

[www.midstatetank.com](http://www.midstatetank.com)



# Purchase A New Truck In 2007 And Write Off Up To \$125,000\*

\* IRS Tax Code, Section 179, allows you to write-off up to \$125,000 if you spend less than \$500,000 in 2007 on equipment purchases. Ask your tax advisor for details on what you qualify for - then give us a call!



### Tank Options

- Aluminum
- Carbon
- Stainless
- X Ten
- Core 10

## In-Stock and Ready For Delivery

- |  |   |
|--|---|
| 4800 Aluminum Septic Tank  | 3600 Aluminum Septic 2008 Kenworth T300     |
| 3600 Aluminum Septic Tank  | 1250 Alum PRT 2007 Ford F550 2x4            |
| 2500 Aluminum Septic Tank  | 1500 Alum PRT 2007 Ford F550 4x4            |
| 3400 X Ten High Tensile Carbon Steel Front Lift (Full Rear Opening Door) | 800 Alum P&D Combo Unit 2007 Ford F550 2x4  |
| 2200 Stainless Steel Premium Septic Tank                                 | 2200 Alum Septic 2007 7500 Chevrolet        |
| 3200 Stainless Steel Premium Septic Tank                                 | 3600 Alum Septic 2008 Peterbilt 340         |
|  | 2200 Alum PRT 2008 Ford F750 AT AB          |
|  | 1500 Alum PRT 2008 Ford F550 2x4            |
|  | 2000 Alum PRT 2007 International 4200 AT AB |

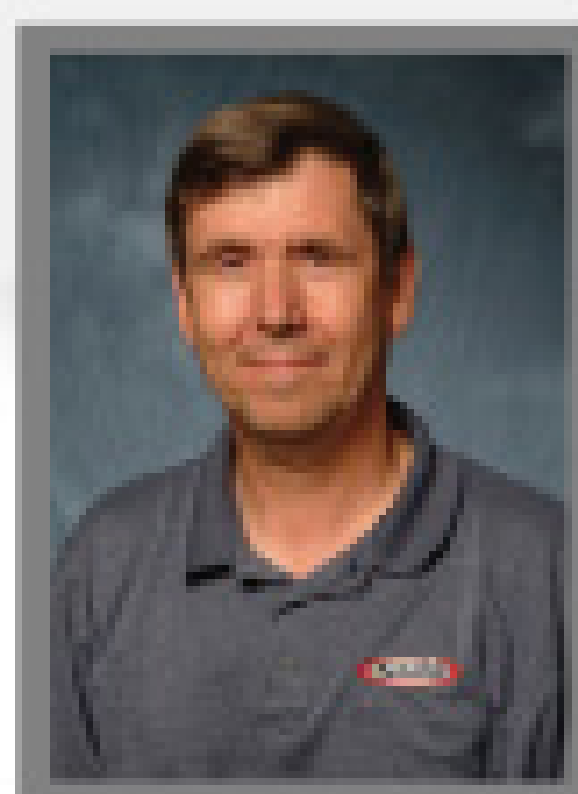

**John Olson**  
Truck Product Sales Manager  
**800-328-3332**



**Wes Tuttle**  
Truck Division General Manager  
**800-328-3332**



*Imagine The Possibilities*

[www.SATELLITEINDUSTRIES.com](http://www.SATELLITEINDUSTRIES.com)



## 7000 Gallon Aluminum



### Manufacturing

- **Stainless Steel**
- **Aluminum**
- **Code & Non-Code**

# 800-589-5254

# ACRO

## Trailer Company



Vacuum Trailers for the  
Liquid Transportation Industry  
Parts • Repair • Complete Pumping Systems

www.acrotrailer.com • 417.862.1758 • fax 417.862.8084 • 2320 North Packer Road • Springfield, Missouri 65803

# Experience Matters.

## Custom vacuum tanks built to your specifications.

For nearly 50 years, our tank builders have been setting the industry standard for innovation and value. Everything we build is customized to your exact specifications. Start with a bare tank and add only the options that are suitable for your application. What about service? Our technicians can rebuild pumps or furnish parts such as vanes, seal kits, housings, and rotors for most pumps. Whatever you need, let us put our experience to work for you.



Bare tank w/no attachments

#### Bare Tank:

Prices are for the tank only with no openings, hatches, rails or other attachments. LMT can furnish items for you to attach to your tank at additional cost. Please call for more information and pricing.



Basic tank w/optional manway and hoses/trays

#### Basic Tank:

Prices include primary shutoff, full length rails (straight or tapered), 4" discharge nipple, and 3" intake nipple.

#### LMT Basic & Bare Tank Prices:

(subject to change without notice)	Basic Tank	Bare Tank
1500 gallon: 54" dia. x 12' long w/1 baffle.....	\$ 4,345.....	\$ 2,958
2000 gallon: 60" dia. x 14' long w/2 baffles.....	5,406.....	4,037
2500 gallon: 66" dia. x 14' long w/2 baffles.....	6,145.....	4,753
3000 gallon: 68" dia. x 14' long w/2 baffles.....	7,162.....	5,728
3500 gallon: 72" dia. x 17' long w/2 baffles.....	8,660.....	7,138
4000 gallon: 78" dia. x 16' long w/2 baffles.....	9,784.....	8,226
4200 gallon: 78" dia. x 17' long w/2 baffles.....	10,272.....	8,689

Custom sizes up to 6000 gallon are available.

All lengths are can length excluding flanged and dished ends. All tanks over 70" dia. have 2 braces of 2" x 3" solid steel to prevent collapse of tank. All tanks are cleaned with an acid solution and prime painted. We can also customize the paint color for an extra fee. Tanks are manufactured with mild steel and are welded with submerged arc process for the best strength and appearance. Stainless steel is available at extra cost.



Call us at 800-545-0174 before you buy!

LMT Inc. - Custom Vacuum Tanks

Tel: 309.932.3311 • Fax: 309.932.3155 • info@tanksandpumps.com

www.tanksandpumps.com

See Us at  
The Expo  
Booth 13055

#### Check out some of the options:

- ✓ Manways (20", 25", 36")
- ✓ Full open door (2 types)
- ✓ Primary & secondary shutoffs
- ✓ Valves for loading & unloading
- ✓ Oil catch mufflers
- ✓ Suction hose & couplings
- ✓ Mounting rails & kits
- ✓ Vacuum pumps (Jurop, Masport, Moro, Fruitland, and others)
- ✓ Hosetrays and hangers

And more...

# MEET THE INSPIRATION FOR OUR NEWEST PORTABLE RESTROOM

**MOMS LOVE OUR  
NEW FAMILY ROOM.  
SEE IT AT THE  
PUMPER SHOW  
BOOTH 1140**



## **FLEXIBLE FINANCING AVAILABLE NOW**

Lower payments... longer terms...  
less interest... deferred payments...  
What do you need?

## **FREE MAGIC SHOW**

Magician Gregg Lambert will be performing daily  
at the **PolyPortables booth #1140**.

Our sincere thanks to good customers who stimulated our thoughts about the problems of parents with infants at events. That's a stressful situation to say the least.

We needed to customize one of our units to fit their needs. (No problem. We often do custom colors and modified designs for our customers.) Our new Family Room unit is the result. It turned out so well, we decided to offer it to everyone.

The new Family Room enables you to offer something new to event promoters this year. Moms love it and it's a great add-on sale for you.



BOOTH 1140



**POLYPORTABLES**

*Listening. Learning. Delivering. Since 1972*

99 Crafton Drive, Dahlonega, GA 30533 USA • Phone (800)241-7951 or (706)864-3776 • Fax (706)864-8111 • [www.polyportables.com](http://www.polyportables.com)

Only PolyPortables offers high-performance Green Way Products

**TOILET DEODORIZERS • TOILET CLEANERS • AIR FRESHENERS • INSECT REPELLANT**

All Green Way deodorizers, cleaners and air fresheners are earth-friendly, people-friendly products. They are developed and manufactured in our facilities in Dahlonega, Georgia by Green Way Products, a PolyPortables sister company.



**Green Way Products**  
solutions for life



# Failure Often Leads to Success

If you're afraid to stumble and fall with a business initiative, you may never reach your potential for success

By Gary Bradt

It took Thomas Edison more than a thousand tries to get the light bulb right. Yet how many of us give up if we don't nail something perfectly the first time out? The best baseball hitters in the game fail two out of three times at the plate. Still, how many of us won't step up and try something new unless we can be assured of success first?

The problem is how we think about ourselves in relation to failure and its consequences. We must change the way we think about failure, and in the process, change the way we think about ourselves.

Failure can be the fast track to success if you recognize and use it the right way. It's all in how you choose to size it up. Following are five ways to handle the disappointment of failure and use the experiences to your advantage, both in business and in life:

## DEFINE FAILURE AS LEARNING

When toddlers fall down, do we say, "Man, they really messed up!" or "Wonderful, they're learning to walk!" Yet when we fall down at work, we often say, "I failed." Worse yet, we may define ourselves as failures. Better to view failure as a temporary and necessary step on the way to where you want to be.

Just like falling down is a predictable and inevitable process for the toddler learning to walk, so too are occasional failures along the way to success in whatever you attempt. In fact, it's hard to improve if you don't fail, because failure delineates clearly where the opportunities for improvement lie.

When you do fall down, don't

label yourself a failure. Instead, recover quickly from the temporary disappointment by asking, "What can I learn from this? What worked and what didn't? How can I do it better next time?" Then, follow the toddler's example: get up with a smile on your face and try again, knowing you are better for the experience.

## MANAGE EXPECTATIONS: YOURS AND THEIRS

Sometimes the problem with failure lies in unrealistic expectations when trying something new. We expect everyone to embrace the new strategy after a single meeting. We expect the new model-year car to perform as well as the old one. We assume customers will flock to our latest and greatest product immediately.

Rarely, however, are such scenarios the case. Newly revised product lines often have bugs, and wary customers often have to be convinced over time that what we offer meets their needs and interests.

Perception about failure on the back end can be reduced or eliminated by managing expectations on the front end. Begin new ventures with optimism tempered by realism, and help your colleagues and customer do the same. Anticipate there will be problems, and let everyone know you will be ready to solve them. That way, when problems do arise, they will help reinforce your credibility versus damage it. And, problems won't lead you and others to assume you've failed. Rather, problems will be viewed for what they are — road signs pointing the way to progress.

## STOP TRYING TO BE PERFECT

Trying to be perfect can keep you from trying new and untested methods for reaching your goals. The valuable experiments that ultimately lead to success will never happen if you are afraid to attempt them in the first place. In a vain attempt at perfection, we might freeze up and keep whatever natural talent we have from taking over.

Rather than strive for perfection, strive for action; bold, resolute action in the direction of your goals. You can make mid-course corrections as you go, but you'll never have the chance if you never get started. Aiming for perfection is fine; expecting it, however, is unrealistic.

## MANAGE FEAR BEFORE IT MANAGES YOU

Perhaps nothing holds us back as much as fear. Fear is our natural protection against threats to our physical survival. Too often, however, fear gets triggered when physical survival is not an issue.

Physical harm won't follow if your idea gets shot down at a meeting. You won't lose an appendage if you return from your sales call empty-handed. Just because fear often gets triggered in these situations doesn't mean you have to succumb to it.

Gather yourself, take a deep breath, tell yourself you're OK, and go about taking your next step forward. Learn to control your fear or it will end up controlling you.

## STAY IN THE MOMENT

"What if?" can be a very useful question for anticipating scenar-

Gary Bradt is author of the book, *The Ring In the Rubble: Dig Through Change and Find Your Next Golden*



Opportunity. He can be reached at [www.ringintherubble.com](http://www.ringintherubble.com).

ios and stirring creativity. "What if we doubled market share next quarter? What if we could take the best aspects of our competitor's products and roll them into ours? What if we could use our expertise to aid the less fortunate in our community?" Good questions all.

Unfortunately, too often our internal dialogue goes more like this: "What if I say something dumb at the meeting and everyone laughs and decides I'm stupid? What if the economy takes a turn for the worse? What if we get bought out and I lose my job?" We begin to imagine negative "what if" scenarios and put so much mental energy into them that we have little left over for more positive endeavors, and failures mount.

To counter this trend, notice when you are becoming anxious. Then, notice your thoughts. Likely, you have mentally raced ahead to some scary place that doesn't exist. Bring yourself back to the here and now. Ask yourself, "What's going on right here, right now?" It's likely not nearly as bad as what you were imagining. Dealing with the realities of the moment will help you avoid creating unnecessary failures in the future.

## A FINAL WORD

If fear of failure is holding you back from pursuing dreams or accomplishing goals, challenge yourself to think again. Reconsider how you think about failure. Often, failure is the first and necessary step toward discovering our fortune; it points the way to success. Perhaps Henry Ford put it best: "Failure is simply the opportunity to begin again, this time more intelligently." ■





## Last Pre-emission Chassis in stock



### 3600 Gallon Alum Vacuum Tank

- 2007 Pre-Emission  
7500 Series IH
- 506 Challenger pumping system



### 6000 Gallon Short Tanker Trailer

- Excellent for Septic &  
Grease Trap Service.
- Call for more Information



**\$3,995.00**



Booth 5199, 5201, 6199

**NVE**  
DISTRIBUTOR

### Toolbox Jetter

- Polished Aluminum Toolbox
- 5 GPM @ 3000 PSI Water Pump With  
Pulsator
- Electric Start Engine
- Remote Fuel Tank
- Electric Rewind Reel With 200' of 3/8" Hose
- Chrome Guide Rollers On Reel
- Washdown Gun With Quick Connect Tips
- (1) Jet Nozzle
- Stainless Tool Rack

*Add Jetting To Your Pump Truck*

**Toll-Free 1.877.557.PUMP (7867)**  
"Partners in Performance"

**Call For A Quote Today!**

[www.AdvancePump.com](http://www.AdvancePump.com)

15418 Old Highway Road • Peosta, Iowa 52068  
877.557.PUMP (7867) • Fax: 563.557.0961



**THE PETE STORE**



2008 Peterbilt Model 330, equipped with 220 hp Paccar PX-6 engine, 2500 RDS Allison Transmission, 22.5 lo-pro rubber, air brakes, vertical exhaust, transynd transmission fluid, tilt steering, dual door stops, heated mirrors, and visors. Mounted with Abernethy Carbon steel 1500 gallon tank (1100 w/400 f) quipped with HXL75V Massport pump, much more. 26k gvw.

**ONLY \$72,900**

**THEPETESTORE.COM**

GREENVILLE  
KNOXVILLE  
BALTIMORE  
RAPHINE  
RINGGOLD  
RICHMOND

FIVE IN STOCK WITH FREE DELIVERY TO ANY OF OUR SIX DEALERSHIPS

CONTACT DEAN BENTON, PETERBILT OF GREENVILLE,  
CALL: 888-630-0536, OR EMAIL: [DBENTON@THEPETESTORE.COM](mailto:DBENTON@THEPETESTORE.COM)



**ALPHA**  
Mobile Solutions

Manufactured by  
Forest River



- Hot water heater
- A/C and heat strip
- 740 ga. waste tank
- 200 ga. fresh water tank

VISIT OUR BOOTH  
11060, 11061, 11063  
AT THE PUMPER SHOW  
FOR FANTASTIC  
DISCOUNTS



CALL FOR INFORMATION OR VISIT OUR WEBSITE  
**1-877-789-1213**  
[www.alphamobilesolutions.com](http://www.alphamobilesolutions.com)



- ◆ We are an authorized distributor of Amthor International steel, stainless steel and 5/16" aluminum vacuum tanks.
- ◆ Numerous units ready for immediate delivery with customized financing and leasing packages
- ◆ Three locations to serve you better with a knowledgeable sales staff

Visit us at the  
# 14028 & 14029

**Contact Tim Albert today**

**Advanced Tank Systems, Inc.**  
MD: (410) 752-5411, PA: (215) 822-1336, DE: (302) 398-3253

Over 60 Years of  
Odor Control Technology

THE COLOR OF  
RAW POWER

SURCO®

**BlueMuscle™**

Our **STRONGEST** Portable Toilet Deodorant **EVER!**



Call Us Today, and Stock-Up on the Strongest  
Portable Toilet Deodorants in the Industry!

1-800-556-0111

## Featured Product



### **NEW!** Potty Fresh® PUMP!

*Wall Spray with Metazene® Odor Neutralizer*

**A blast of instant, long-lasting  
odor protection for portable toilets.**

Problem odors causing customer complaints?  
New Potty Fresh® PUMP attacks stubborn odors at  
the molecular level with Metazene® odor neutralizer.  
Simply spray on PT walls and around urinal (not on  
floors, causes slippery conditions) for instant,  
long-lasting extra odor protection.  
Choose powerful Cherry or French Bouquet fragrance.



Now Serving  
**Canada**  
from Our Toronto  
Warehouse

©2007 SPI



**SURCO®**  
PORTABLE SANITATION DIVISION

**1-800-556-0111**

292 Alpha Drive • Pittsburgh • 15238  
412-252-7000 • fax 412-252-1005 • [www.surcopt.com](http://www.surcopt.com)

**Visit us at booth 164!**



# It's like free cash from Hampel.



No monthly payments until June 2008.  
Zero % interest, free financing.

Take advantage of this limited time offer on the world's most durable portable restrooms –  
the 1.5, Country Classic and Global from Hampel\*.



Engineered for strength, durability and value.

[www.hampelcorp.com](http://www.hampelcorp.com) • 800-549-1558



**The Country Classic**



**The 1.5**

Limited Time Only,  
Call Today!

West – Jim McCoy  
800-549-1595

Midwest – Jeff Peltier  
800-549-1596

Northeast – Patrick VanTyle  
800-549-1594

Southeast – Brian Sorensen  
800-549-1598

Corporate  
800-549-1558

Hampel Corp. features the most rugged and durable restrooms available.

Whether you're serving the construction industry, high-end special events or anything in between – Hampel has a restroom for all your needs.



**Booth 4171**



**The Global**

**Call Today!**  
**1-800-549-1558**

\*For qualified buyers only.  
Call for details.



# No COMPROMISE



**Don't accept a substitute for quality. The Burks DC-10 is still the most popular, high volume washdown pump available.**

*With flow rates to 20 gpm and pressure to 40 psig, the Burks DC-10 is the pump of choice for filling and washing your portables.*

*Contact your local tank manufacturer for more info, or call us toll-free at:*

**800-699-7557**

**ARMSTRONG  
EQUIPMENT  
INC.**

11200 Greenstone Ave. • Santa Fe Springs, CA 90670  
562-944-0404 • Fax: 562-944-3636

[www.vacpump.com](http://www.vacpump.com)

PUT THE SQUEEZE ON WET WASTE ...  
With Belt Filter Press Dewatering



Rentals

Skid Systems

Mobile Units



Made in the USA



Touch Screen Controls

Highest Dewatering Throughputs available

Stainless Steel Construction on Frame, Rollers and pans

Grease Trap Waste

Septage Waste

Industrial Waste

Toll Free: 800-253-0532

Phone: 269-793-7183 Fax: 269-793-8793

127 N. Water St., Hopkins, MI 49328

Contact: Julie VanderMoore at  
julie@brightbeltpress.com  
269-793-3423  
[www.brightbeltpress.com](http://www.brightbeltpress.com)

## Inventory of New & Used! We Build Pumper Trucks

- ✓ 1,500 Gooseneck Vacuum Trailers
- ✓ 1,500-3,400 Gallon Vacuum Trucks

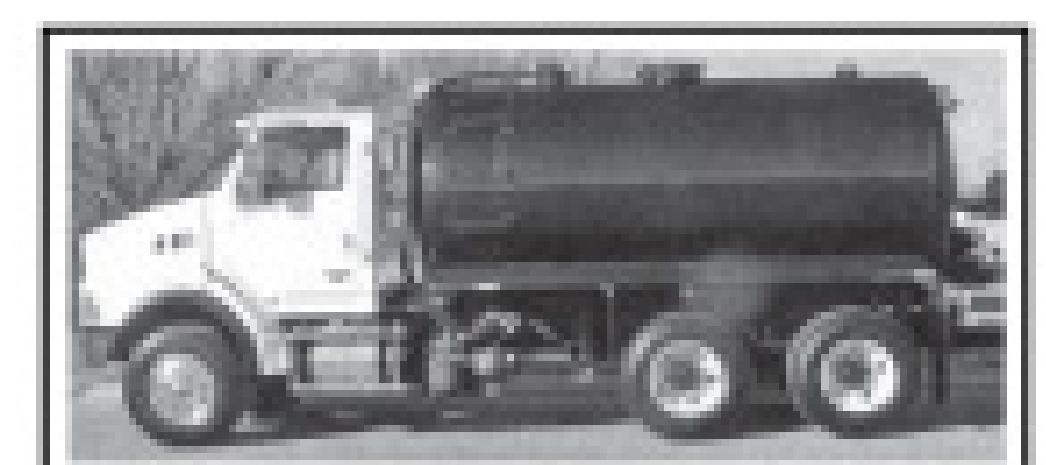
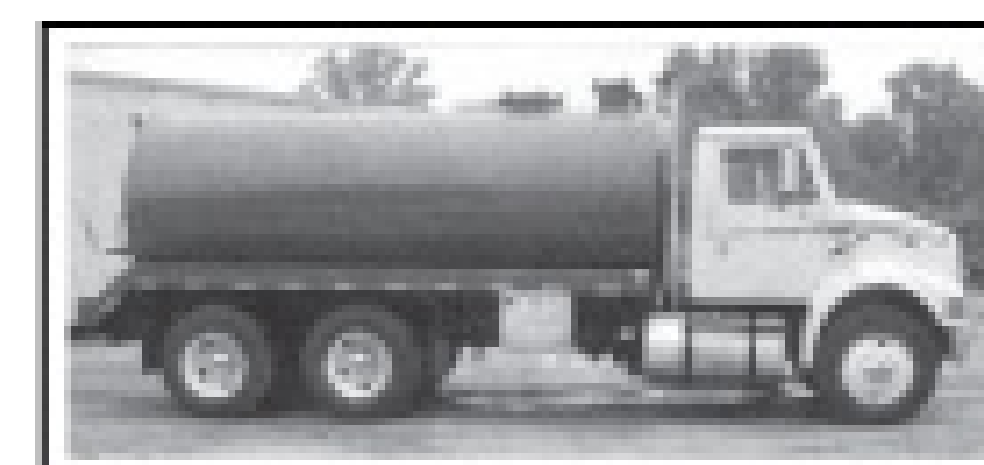

Moro Pump Dealer



Redneck Trailer Parts Dealer



**B&W .. Because Nobody Has Time for Down Time**



ALL TANKS ARE MADE IN THE USA  
ALL TANKS ARE COMPLETED AND THEN PRESSURE TESTED

**B&W MANTRAD INCORPORATED**  
4000 E. Jackson • Macomb, IL 61455  
309-837-1989 • fax 309-837-1919 • [bandwent@macomb.com](mailto:bandwent@macomb.com)

40 Years  
Experience

**CALL TODAY  
FOR INFORMATION OR PRICES  
ON TANKS, PUMPS AND ALL PARTS**

# The Hunt for the Perfect Truck is Over

**Come  
finish the  
hunt at the  
Pumper  
Show  
Booth #:  
4155**



Still in the blind for the perfect truck? Let Jack Doheny Supplies be your hunting ground. With our herd of remanufactured, work ready and rental equipment in stock and on the ground your hunt is over. So impress your customers and bag your trophy truck at Jack Doheny Supplies.



Vactor Sewer Cleaners



Industrial Vacuum Loaders



Hydro Excavators



Cusco DOT Units



Sewer Equip. Co. Jettors

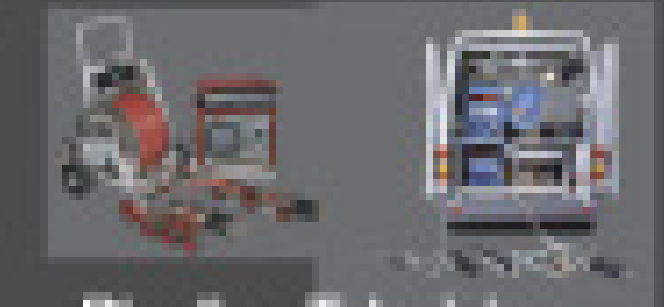

Pipeline Television  
Inspection Equipment

## Jack Doheny Supplies



*"World's Largest Distributor of Sewer Cleaning,  
Air Handling and Street Sweeping Equipment"*

**Call Jack Doheny Supplies  
to schedule your hunt**

# 800-336-4369

[www.dohenysupplies.com](http://www.dohenysupplies.com)



# Texas Relaxes Onsite Inspection Rules

By **Scottie Dayton**

Last September, a new Texas statute went into effect that relaxes onsite inspection requirements. It states that rural residents may maintain the systems instead of relying on service companies to inspect them three times a year. Furthermore, residents are no longer required to file periodic county reports to prove systems are working properly.

Collin County commissioners are debating whether to pass an ordinance requiring rural homeowners to be trained in how to maintain onsite systems and report test results to the county. Some North Texas counties, including Dallas, Denton and Ellis, already have passed local rules that override the state

guidelines. Collin County has more than 12,000 onsite systems, while Dallas County has about 700 systems.

The new law resulted from homeowners complaining to legislators that some service companies did shoddy work. Others complained about the \$200-a-year maintenance fee. The Texas Commission on Environmental Quality is not making a recommendation on whether counties should enact local inspection requirements.

## WISCONSIN

A bill introduced in the State Senate will prevent county regulators and other government employees with duties related to onsite systems from installing,

maintaining, repairing, selling, or designing systems and performing soil tests. The goal is to prevent these employees from competing against the people they regulate.

As of Jan. 1, a tracer wire or an equivalent means of locating is required when installing all non-metallic sanitary, storm, and water laterals that connect to municipal mains. The suggested installation method is to bury at least 12-gauge, plastic-coated copper wire within 6 inches and directly above the top of the pipe. The wire should be brought to the surface every 400 feet and protected at those access points.

Tracer wire for sanitary sewer is green, storm sewer is brown, potable water is blue, and reuse water is purple. Installers should check with municipalities for local ordinances concerning tracer wire installation.

The state's new budget continues the Private Sewage System Repair and Replacement Grant Program that allocates \$3 million annually to low-income residents.

The budget also increases vehicle registration fees for heavy trucks (more than 4 tons) by 30 percent. Before Gov. Jim Doyle signed the budget, Wisconsin Onsite Wastewater Recycling Association executive director Patrick Essie spoke with the governor's staff about how the increases would affect the industry. Current fees of \$119.50 (5 tons) to \$1,969.50 (40 tons) increased to \$155 to \$2,560.

## OHIO

The Household Sewage Treatment Study Group, created in an Ohio House bill that suspended the state's current onsite

*"Rules and Regs" is a monthly feature in Pumper. We welcome information about state or local regulations of potential broad interest to onsite contractors. Send ideas to editor@pumper.com.*

**"There are more than 1,000 cases where onsite rules are causing an economic hardship to landowners. In some cases, new systems cost more than the houses they will serve, making people leery to build homes."**

Tim Grendell

rules until July 2009, is rewriting legislation mandating sophisticated and costly onsite systems. Advocates are seeking new rules that protect the environment without causing a financial burden to property owners.

The group will examine the situation throughout 2008, then deliver a report to state leaders at the end of the year. Until then, counties will follow onsite regulations in effect before January 2007, when the more stringent rules took effect.

"There are more than 1,000 cases where onsite rules are causing an economic hardship to landowners," says Tim Grendell, who represents Ohio's 18th State Senate District. "In some cases, new systems cost more than the houses they will serve, making people leery to build homes." Ray Saporito, Ashtabula County health commissioner, said he is certain some building permits in the county were not pulled because of uncertainty over septic system regulations. ■



Simple Software for Your Service Solutions

## The Leading QuickBooks® add-on Software for today's Portable Sanitation Business.

- Interface with QuickBooks®-The Service Program generates your recurring route billing and seamlessly allows you to print the invoices in QuickBooks®.
- Easily Manage Routes
- Track Pick-Ups & Drop-Offs
- Palm and Windows PDA Handheld Support w/Remote Sync
- Works with Mapquest®
- Track Inventory at Multiple Locations
- 30-Day Money Back Guarantee-Leasing Available

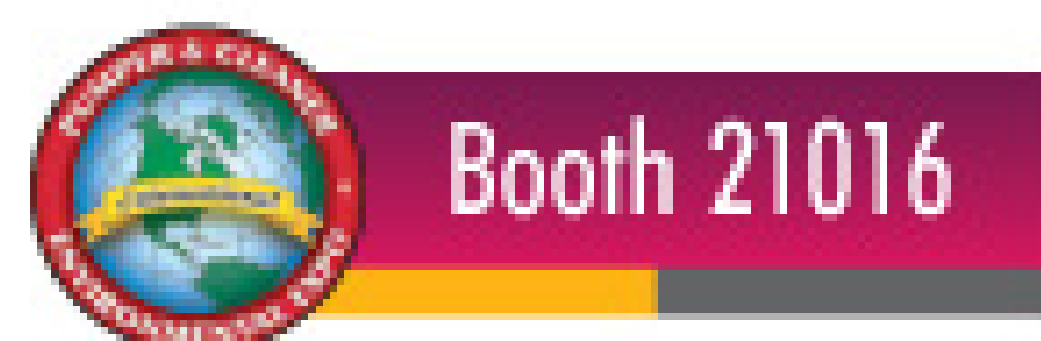

Booth 21016

866.480.1879

www.theserviceprogram.com

# WHAT DO YOU NEED TO STOCK YOUR BUSINESS NOW?

- lower payments...
- longer terms...
- less interest...
- deferred payments?

Why limit your options to inflexible delayed payment plans when you can choose the options that are best for you?

**FLEXIBLE FINANCING\*** on trucks, restrooms and hand-wash stations enables your money to work harder for your business.



Call your regional manager at **(800) 241-7951**  
or visit **Booth 1140** at the Pumper Show



BOOTH 1140

\* Flexible Financing options are provided by multiple third-party sources and are contingent on completion of a satisfactory credit application.



# Black Tie Manufacturing Now Offers 8' Restroom Trailers Starting at \$13,900!

Unlike our competitors,  
Black Tie  
standard features include:

- Stair System
- AC/Heat Strip
- Waste Tank
- Hot Water Tank

We CUSTOMIZE and offer  
attractive Financing Programs.

Call **877-253-3533**

[www.blacktiemanufacturing.com/diamond](http://www.blacktiemanufacturing.com/diamond)



Sample floor plans

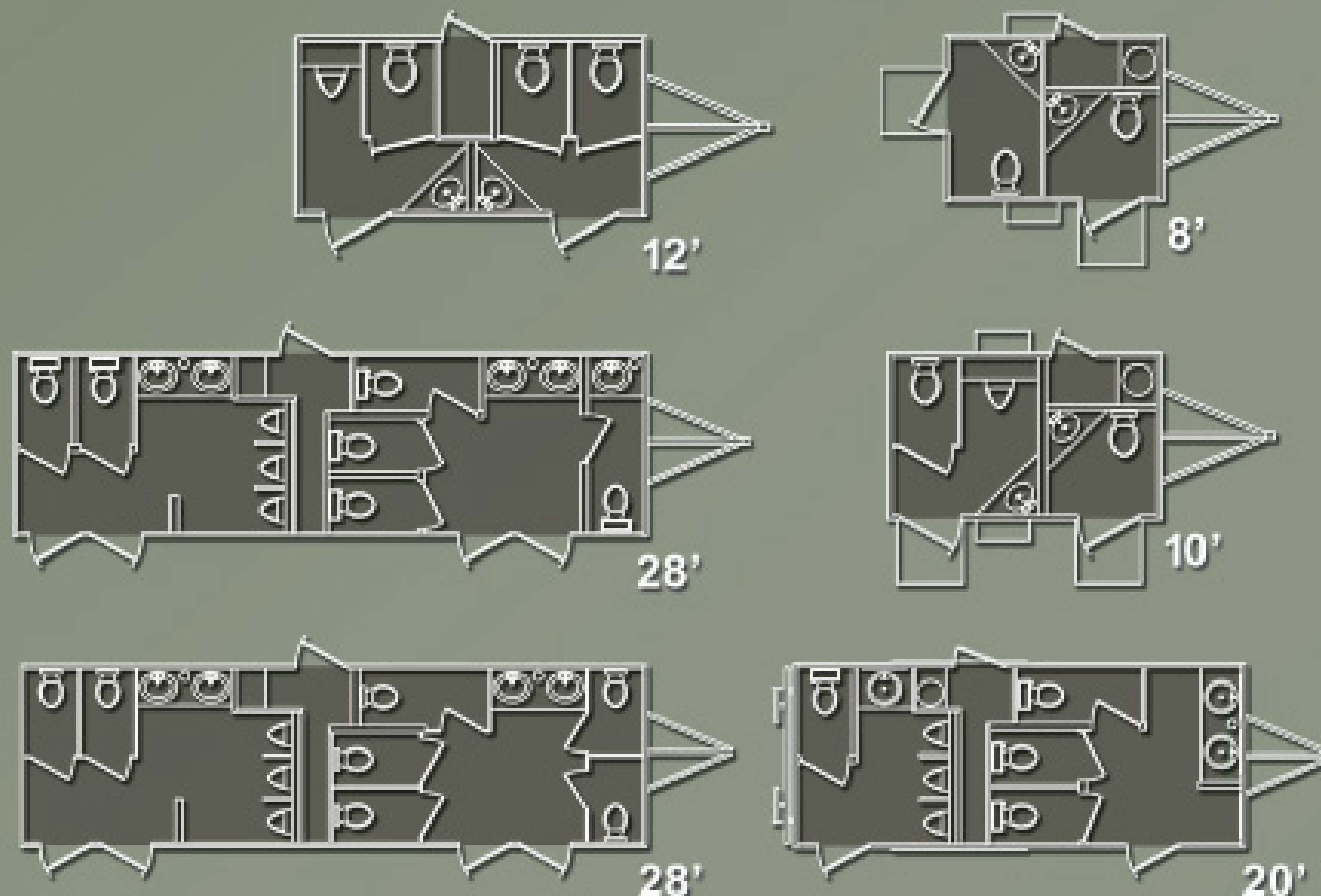

© 2007 BLACK TIE MANUFACTURING, INC.

Introducing the **BLACK TIE**

# Re-Rental Program

## BTM

Black Tie Manufacturing (BTM), the nation's leading manufacturer of quality mobile restroom and shower suites.

## BTES

Black Tie Event Services (BTES), the nation's leading provider of mobile restroom and shower trailers.



When BTES needs additional equipment, BTES calls your company and provides you with an opportunity to rent your BTM trailer to them. Your participation could include all sanitation services.

## RESTROOM RENTAL COMPANIES

If your customer's event requires more restrooms than you own, call BTES to provide your company with the trailers you need.



## BTES Partners

*"Current owners of BTM equipment"*

When you purchase a mobile restroom trailer from Black Tie Manufacturing (BTM), you become a rental resource of our affiliate Black Tie Event Services (BTES). Your equipment purchase automatically enrolls you in Black Tie's exclusive Re-Rental Program, which increases your opportunity to generate higher rental revenue. No other manufacturer can offer you this unique opportunity.

***"Black Tie and You. It's a Jewel of a Relationship!"***

Call **877-253-3533**  
toll free

\* Attractive Financing Programs Available



[BLACKTIEMANUFACTURING.com/diamond](http://BLACKTIEMANUFACTURING.com/diamond)  
[show@blacktiemanufacturing.com](mailto:show@blacktiemanufacturing.com)

Visit us at  
**BOOTH 7179**





# Michigan Vacuum Trucks

**Custom Built Tanks to Your Specs!**

P.O. Box 234 Carleton, MI 48117



## Custom Built Vacuum Trucks to Meet Your Business Needs

**All trucks are equipped with Masport Pumps  
1/4" Steel Construction**

### Commercial Financing Options Available

Contact Anita McClintock  
Cypress Financial Corp.  
1-800-433-6189 ext110

### THANK YOU

U.S. Ecology Idaho for purchasing a 4000 gallon vacuum unit from Michigan Vacuum Trucks.

**Masport<sup>®</sup>**  
**NVE**

Specializing in  
New Vacuum Trucks,  
Used Vacuum Trucks,  
Toilet Trailers & Slide in Units.

Purchase a New Portable Toilet Truck for only \$45,000\*

Purchase a New 2,500 Gal. Vacuum Unit mounted on a New Kenworth T-300 Chassis Ready to Pump for only \$69,000

We Can Also Mount a Custom Designed Vacuum Tank on Your Chassis!

**Call for a FREE quote today!**

**734.777.0390**

\*Prices are subject to change.



## Aqua-Zyme Disposal Systems

*"From the Grease Trap to the Garden"  
- Dewatering & Composting -*

**#1 Box on the market!**

### The ADS Dewatering System

is built by a pumping company for pumpers. You are welcome to come and watch the 30 yard box dewater 20,000 gallons of grease trap waste and/or septic tank waste in only 2 hours!

By using the ADS dewatering system along with our Compost Facility, we have turned our disposal costs into a profitable venture!

**Call 979-245-5656 for Info!**  
**\$ Financing Available \$**

P.O. Box 489, Van Vleck, TX 77482 • [www.aqua-zyme.com](http://www.aqua-zyme.com)  
1-979-245-5656 • [zymme@aqua-zyme.com](mailto:zymme@aqua-zyme.com) • U.S. Patent # 6,364,122



Filter Box Interior



Booth 163

Draining Down

Irrigation fittings are for irrigating – NOT vacuum.  
 How many dollars are you spending **SUCKING AIR?**  
 Industry-proven, quality vacuum couplings from Bandlock  
 will put money into your pockets.



BANDLOCK BL  
 4" to 12" MR Male Coupler



BANDLOCK BL  
 4" to 12" FR Female Coupler



Aluminum Coupler RLM  
 6" and 8" Aluminum  
 Male Weldon



Steel  
 Crown  
 4", 6"  
 and 8"  
 Press  
 End

**CLOSE TOLERANCE  
 COUPLERS AND  
 FITTINGS BRING  
 "SAFETY" TO YOUR  
 WORK PLACE.**



**Booth 4080**

**Recognized  
 as the  
 #1  
 Relief Valve  
 in the  
 World**



Aluminum Pipe with Steel Press Ends,  
 Steel Pipe Weldons, Aluminum Weldons

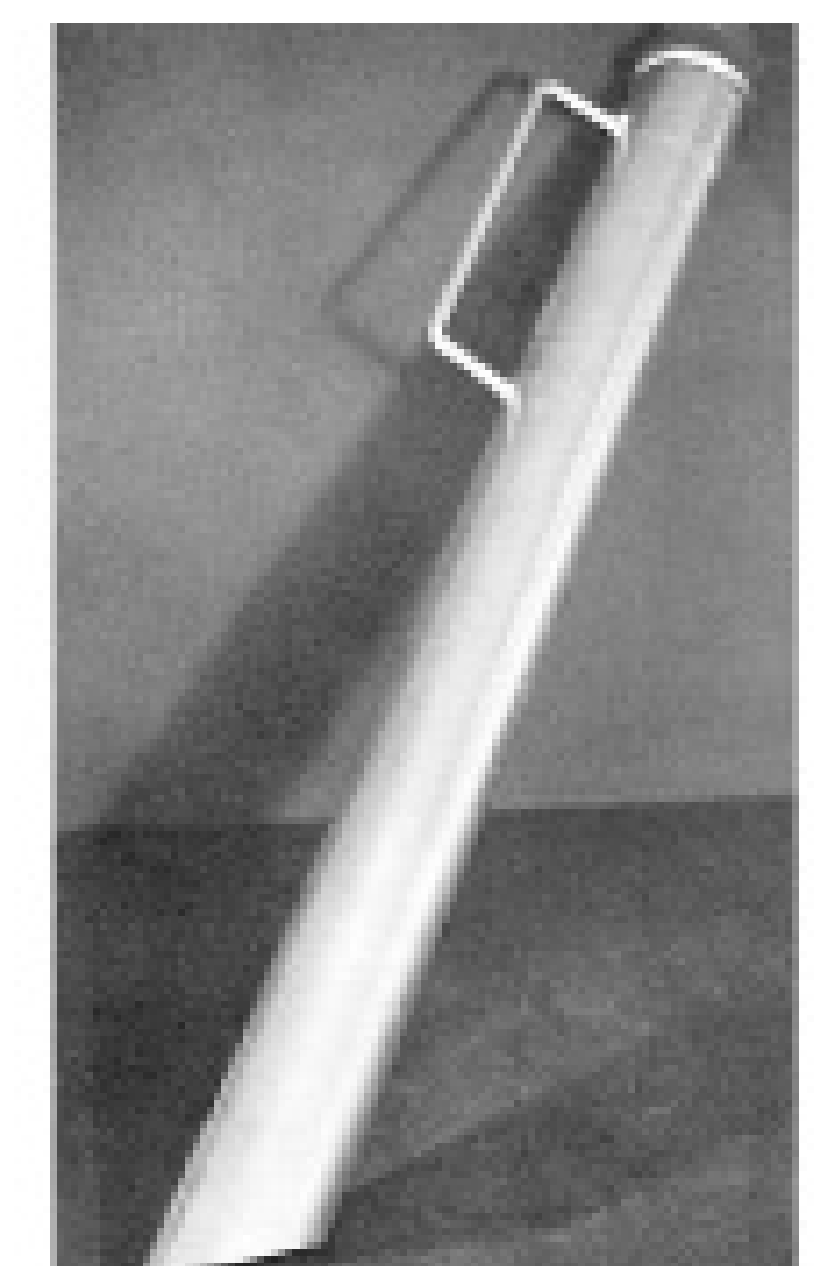

4" and 6" High  
 Abrasive Bulk Nozzles  
 Steel Reinforced



BANDLOCK Reducers  
 BL-300  
 All Size Combinations



Special "Y" Reducer  
 Any Size



Special "Y" Plus Reducer  
 Any Size



Special "Y" Plus Reducer  
 Any Size



BANDLOCK "Y's": BL "Y"  
 4" to 12"



BANDLOCK Safety Discharge  
 Female Coupler, Male Coupler  
 BL-SFR 4" to 12", BL-SMR 4" to 12"

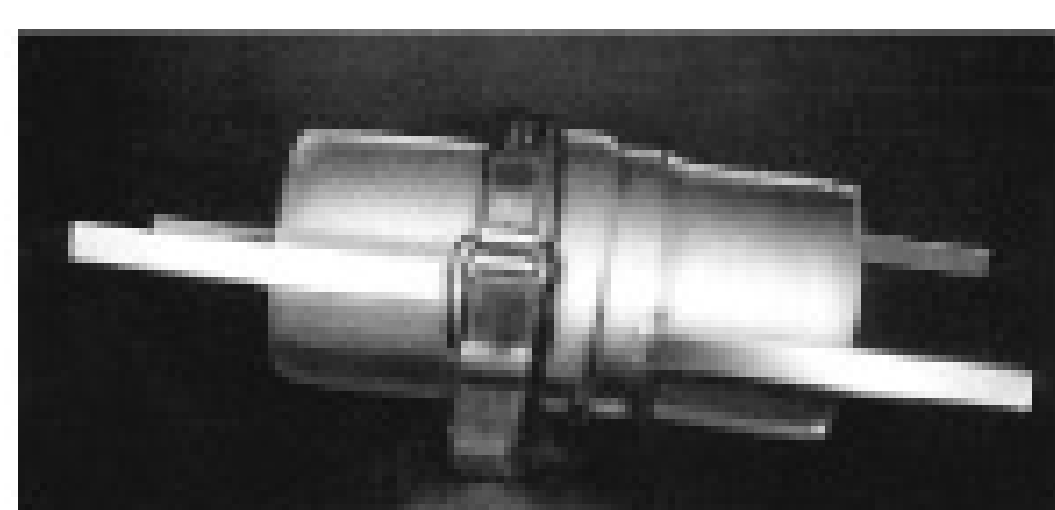

BANDLOCK Safety Discharge  
 Coupler - Male Clamp, 2 Gaskets,  
 Clamp with Safety Straps



BANDLOCK Clamp  
 Standard and International  
 BLB 4" to 12"

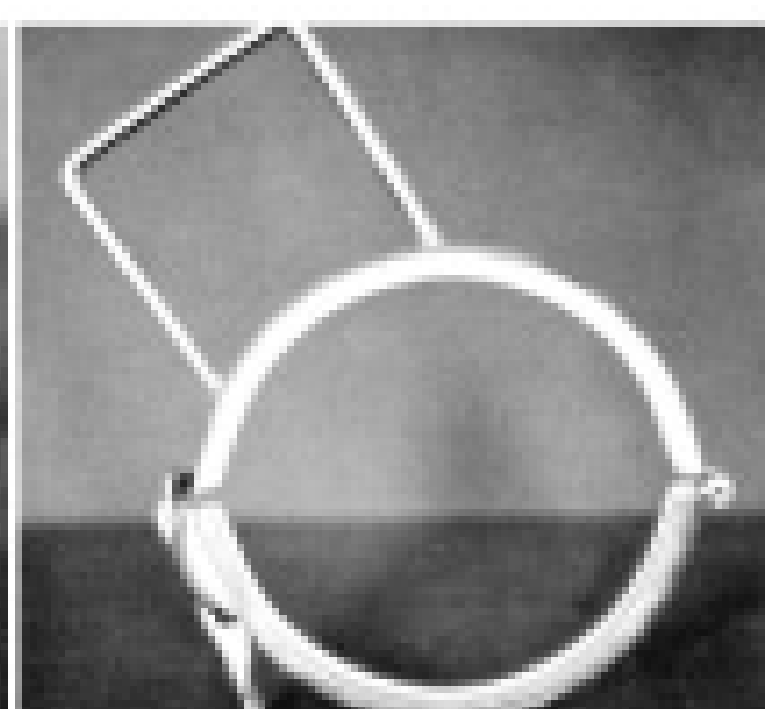

BANDLOCK  
 EZ Lift Clamps  
 BLB-EZ 4" to 12"

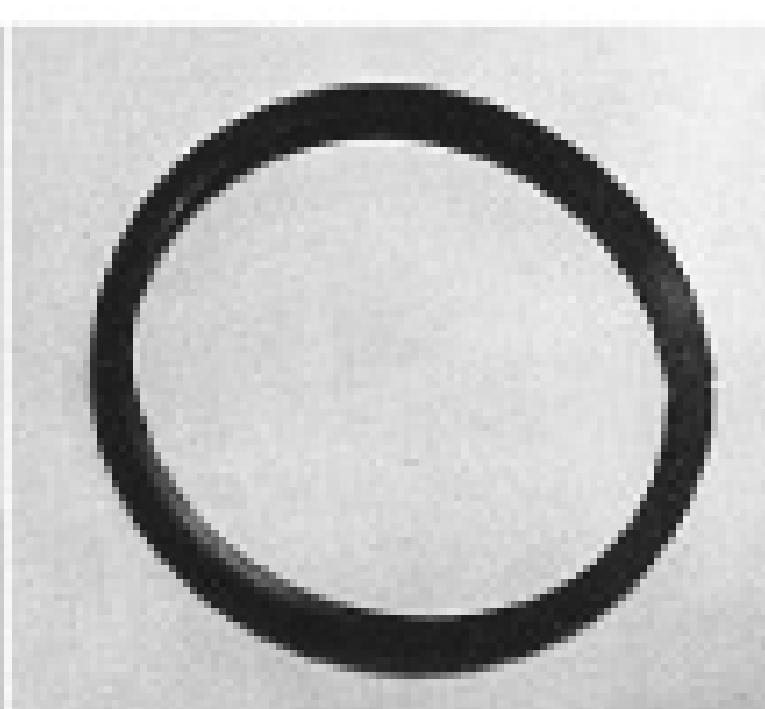

Profile Gaskets (Safety)  
 4" to 12" Seals  
 for Hazardous Materials



GO - 4" to 12"  
 Rubber Gaskets



Male and Female  
 BL-500M or BL-500F End Plug  
 4", 5", 6", 8", 10" & 12"

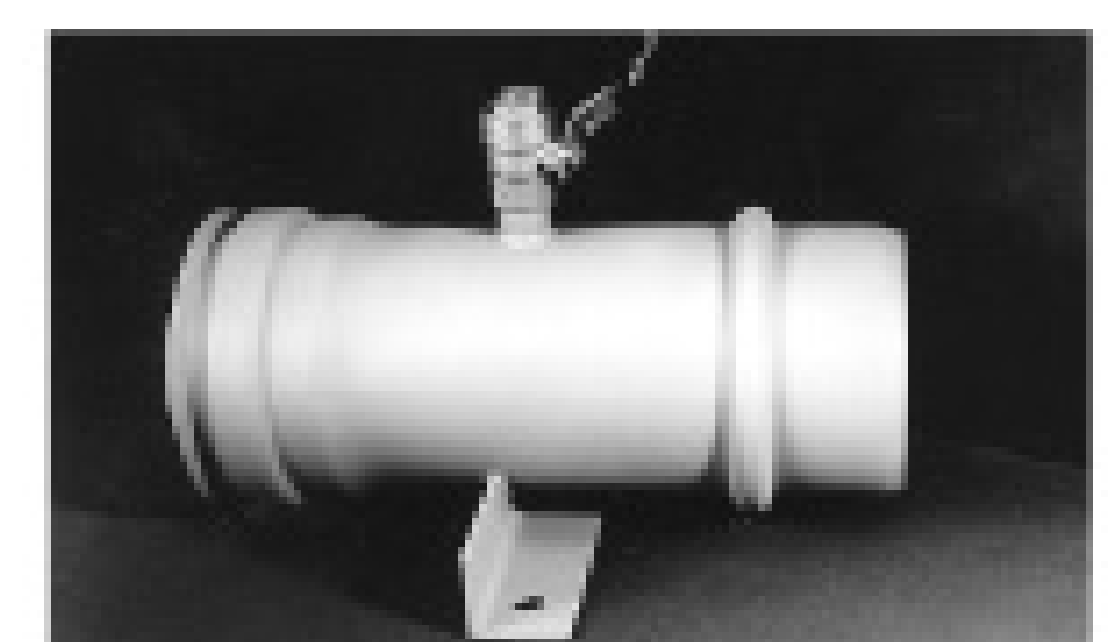

Wet Valve, 6", 360° Injected

**BANDLOCK  
 Corp.**  
 MADE IN THE U.S.A.

SUPERIOR "QUICK" CONNECT VACUUM AND PRESSURE COUPLINGS AND ACCESSORIES

Call or fax today to get your catalog!

**1-800-659-2978**

**Fax: 909-930-2551**

**www.amesbury.com**

jcario@amesbury.com



## REPLACEMENT PARTS & ACCESSORIES



70 Degree Elbows



Tyger Tails®



Replacement Fans

High Pressure Water Pumps



We Accept:



2 Way & 3 Way Ball Valves



Straight & 90 Degree Swivels

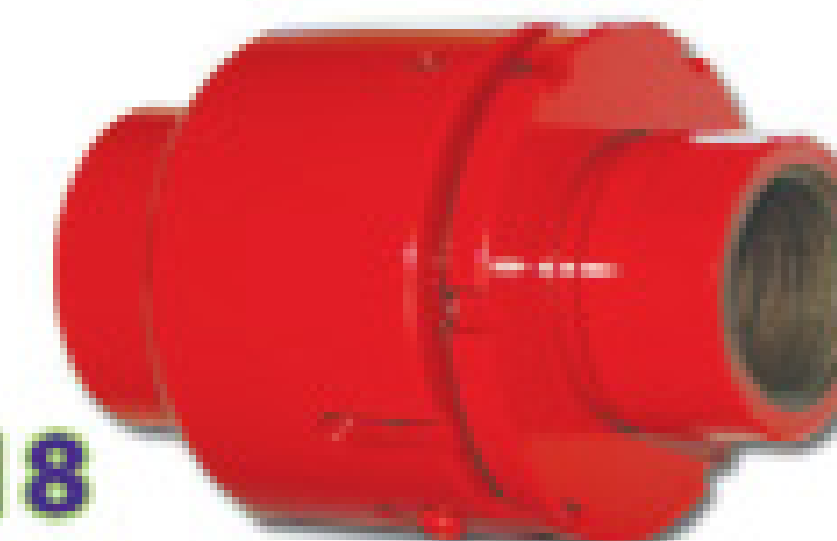

See UEMSI in Booth 3218



**UEMSI**

PIPELINE CLEANING & TELEVISION EQUIPMENT

BUY NOW

[www.uemsi.com](http://www.uemsi.com)

Buy Online 24/7

Corporate Office: 1.800.666.0766 • Fax: 1.800.691.0031

[www.uemsi.com](http://www.uemsi.com) • E-mail: [info@uemsi.com](mailto:info@uemsi.com)

## Oil Skimmer Sucking up money for vacuum trucks

Many times when oil is spilled, vacuum trucks are called for clean up. A vacuum truck using our skimmer will always get the job over a conventional rig because a vacuum truck using our skimmer is:

- 97% efficient
- Environmentally efficient
- Cost efficient
- Equipment efficient
- Simple and easy to use
- Recovers all types of oil
- Ideal for pits, lagoons and industrial oil recovery operations

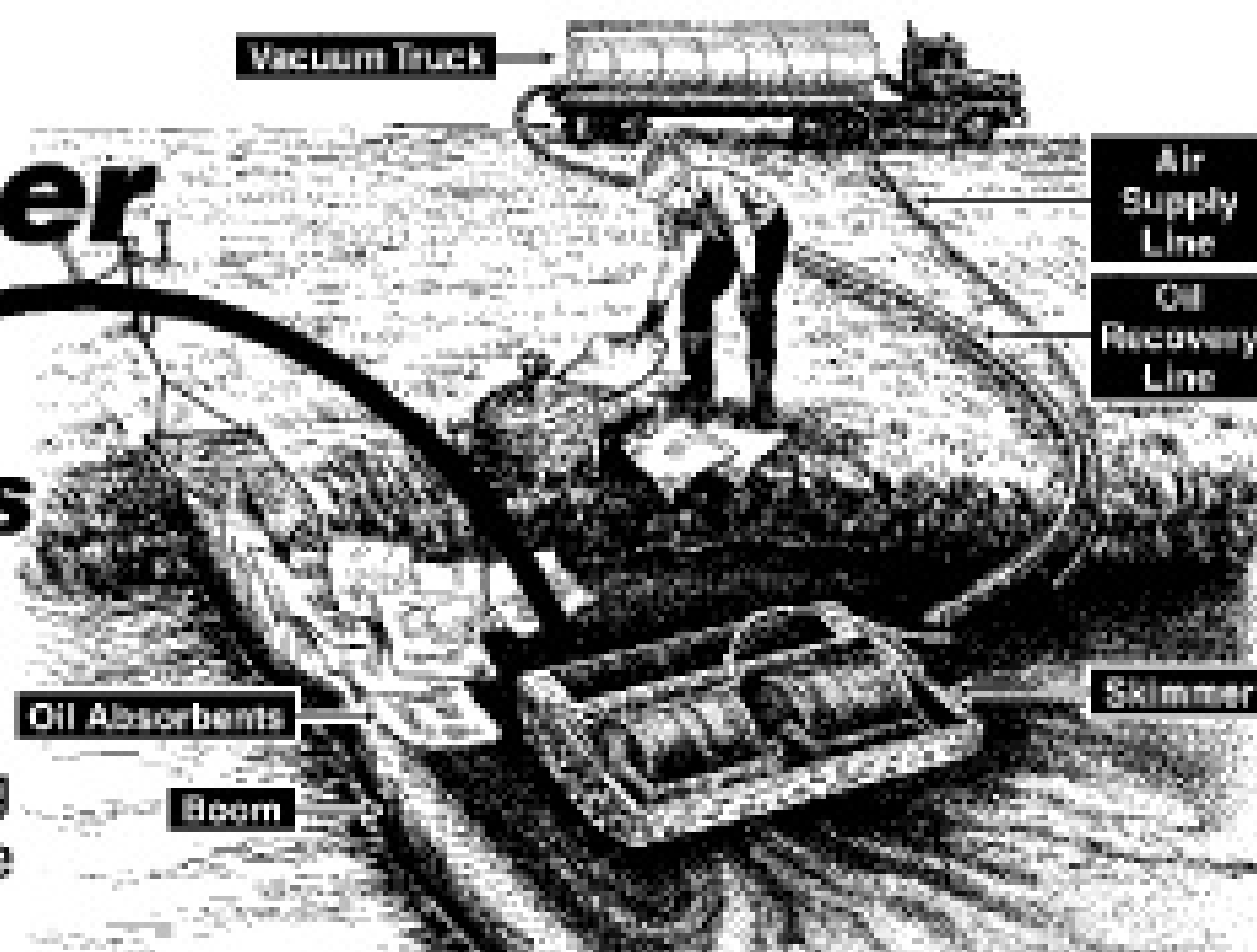

## DrumIt The drum filling vacuum head with auto shut off



DrumIt quickly connects to vacuum truck. Ideal for chemical, oil or hazardous materials. Works on liquids, solids and sludges.

## Trailer Mounted Vacuum Systems are Our Specialty



PACS is designed for easy dumping with fully opening rear door.

- Wide flotation tires and surge brakes for highway or off-road
- Various models available
- Standard units normally in stock
- Built with heavy-duty components
- Low maintenance with simple controls
- Designed for ease of towing
- Automatic mechanical shutoff
- Efficient and easy to use
- Extra strong frame withstands the difficult conditions of remote locations

Call for more info.  
**(618) 382-2525**

[www.elastec.com](http://www.elastec.com)

**ELASTEC**

**AmericanMarine**  
FOR INNOVATIVE ENVIRONMENTAL PRODUCTS

121 Council St., Carmi IL 62821 • Tel: 618-382-2525 • Fax: 618-382-3610 • Email: [elastec@elastec.com](mailto:elastec@elastec.com)



# Factory Built-Work-Ready IN STOCK Selection of *progress tank* Vacuum Service Truck Tanks

## NEW! Mid Range - 22,000 GVW-2008 Kenworth T300

Cummins diesel, Allison automatic, Hydraulic brakes,  
Air Conditioned, AM/FM, Air suspension drivers seat,  
**1700 Gallon *PO77ΔVAC* Restroom Service**  
400 fresh / 1300 waste Masport HXL 4 Vac pump  
with pre-filter, Burks DC 10 wash down,  
Hot shift PTO w/ remote 4" Discharge,  
Unit hauler and tow package.

**\$73,900**

Lease from **\$940.** mo.



Unit #1239

**2200 Gallon Restroom Tank**

HXL 75 pump, Burks DC10 washdown  
2008 Ford 750 Auto trans., air brakes

**\$79,104**

Monthly lease from **\$1,582**



Unit # 1273

**1500 Gallon Restroom Tank**

HXL 4, dual service, 2 reels  
2008 Isuzu NRR Auto., hyd. brakes

**\$69,500**

Monthly lease from **\$1,390**



Unit # 1276

**2000 Gallon Restroom Tank**

HXL4, Dual Service, 2 reels  
2007 International 4200 Auto., air brakes

**\$77,230**

Monthly lease from **\$1,546**

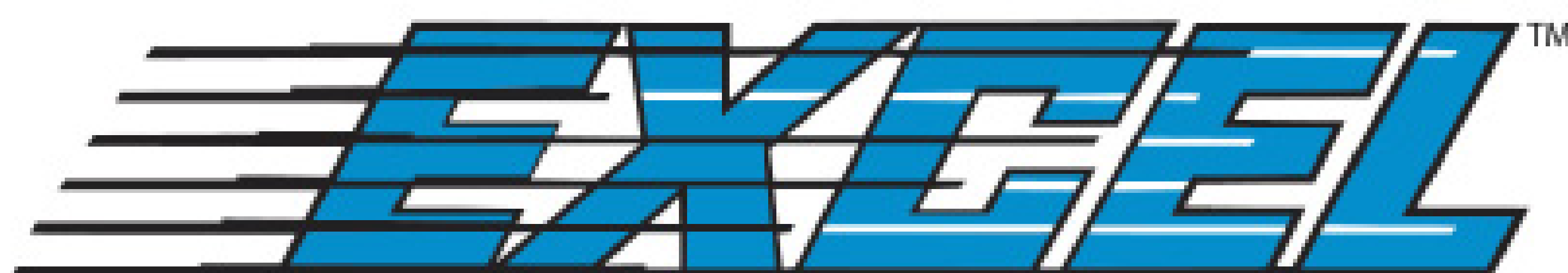

**EQUIPMENT & SUPPLY CO INC.**

**1-800-392-3513**

[www.excel-equipment.com](http://www.excel-equipment.com)

Tel: 317-882-1300 Fax: 317-889-0052

585 Sayre Court, Greenwood, IN 46143

Unit #1124

**800 Gallon Combo Unit**

10' Bed with Liftgate Dual Service  
2007 Ford 550 XLT Upgraded interior,  
power windows, locks and mirrors.

**\$72,230**

Monthly lease  
from **\$1,446**



Unit # 1303

**4200 Septic Tank**

Masport HXL400 water cooled.

**2007 Sterling 9500**

58,000 G.V.W.,  
410/450 HP, 10 speed

**\$128,000**

Plus FET

Monthly lease from **\$2,560**





Before buying your next storage tank, think about this...

## Are All Liquid Storage Tanks Created Equal?

It's Not Even Close!

Features or Benefits	V.E. Enterprises	The Competition
Assembled by Full Time ASME Certified Welders	✓	?
ASTM Grade SA-36 Steel Construction	✓	?
Deep Well "U" Shaped Wall Corrugations	✓	?
6" x 12" Floor Supports (Broader Footprint)	✓	?
1/4" Carbon Steel Top, Sides and Bottom	✓	?
Efficient "V" Shaped Floor Bottom	✓	?
Walls Welded by Sub-Arc Welder (100% Penetration)	✓	?
22" V.E. Sealed Manways, Front, Side and 20" Top	✓	?
Reinforced 5th Wheel Bracing	✓	?
Full Width Ladder/Porch - Easy Access To Top Manway	✓	?
DOT Approved Lighting and Bumper Standards	✓	?
Tanks Steel Shot Blasted, 2.5 mil Anchor Profile	✓	?
Seven Major "In-Process" Quality Inspections	✓	?
Sixty (60) Point Final Inspection	✓	?
Dupont Incon 3.5G DTM Industrial Grade Paint	✓	?
Cathodic Epoxy Coating, 15 mils Thick (Optional)	✓	?
30 Years of Tank Building Experience	✓	?

Setting the Standard For Liquid Storage and Transport Markets Since 1987

800-234-2329

www.veenterprises.com  
sales@veenterprises.com

10834 St. Highway 53 • P.O. Box 389 • Springer, OK 73458

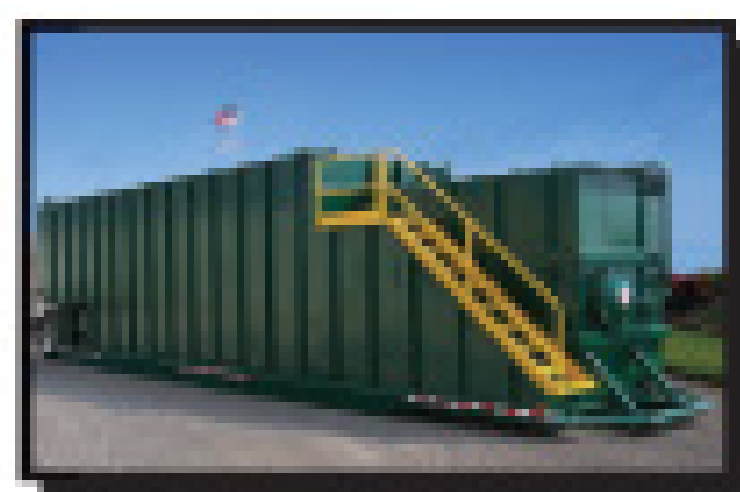

Side-Step, Smooth Wall, 510 BBL.



Single Step, 510 BBL.



Double Wall, 390 BBL.



Flat Top, 500 BBL.

**VE**  
ENTERPRISES, INC.

# A&L Systems

25415 Glendale  
Redford, MI 48239  
Phone: 313.533.7100 or  
**800.592.5253**  
www.a-and-l-systems.com

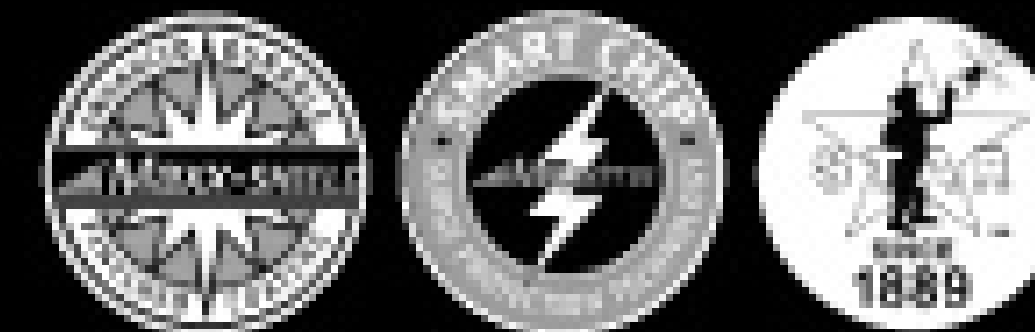

## Heavy-Duty Lighting & Accessories

Automatic On/Off Motion Sensor

Now With Theft Deterrent Mounting Brackets 3 LED's for Greater Illumination

The battery operated LED Light automatically turns itself on when motion is detected by the built in sensor and turns itself off 30 seconds after you leave the area. Dusk to dawn sensor prevents daylight activation.

White LED Lights  
Stop/Tail/Turn Lights  
LED Lighting  
LED Clearance Marker Lights  
LED Front Air Cleaner Lights  
Halogen Driving Light Systems  
Strobes • Revolving Lights • Flashing Lights  
Visor Lights • Remote Power Supply  
Traffic Safety • Bar Lighting • Alarms



Booth 10043

View Our Entire Line at:  
www.grnleafinc.com

## MANUFACTURER OF liquid handling PRODUCTS



VISIT BOOTH  
**4028**

**GREEN LEAF**  
INCORPORATED

An ISO 9001/Q 9001 Certified Company

P. O. BOX 88 • FONTANET, IN 47851 USA • P/ 800-654-9808 • F/ 812-877-4278 • W/ www.grnleafinc.com • E/ sales@grnleafinc.com





LEARN HOW YOU CAN MAKE  
10 TIMES MORE MONEY THIS YEAR.

**The Aquaworx Remediator™.**  
**The permanent non-invasive solution to  
malfunctioning septic systems.**

When facing a failing septic system, the common solution requires heavy equipment, can take a lot of time and result in costly landscape damage. But the Aquaworx Remediator takes only half a day to install using hand tools and rejuvenates failing septic system with nearly the same site damage as a pump out.

Easy to install, simply insert the Aquaworx Remediator into an existing septic tank, and in as little as two weeks, the system is restored. It works by simply enhancing the natural treatment process in which oxygen and bacteria work together to re-establish and maintain a clog-free septic system. Once installed, the Remediator allows installers an annual maintenance opportunity, allowing further growth to your business.

Inexpensive to both operate and maintain, the Aquaworx Remediator is the homeowner's preferred solutions for aging wastewater drainfields. Come learn more about the Aquaworx Remediator by stopping by booth # 4081 at the Pumper & Cleaner Environmental Expo.

 **AQUAWORX  
REMIEDIATOR™**  
by INFILTRATOR®

877.278.2979  
[www.aquaworx.com](http://www.aquaworx.com)



Profile

**Alpena Septic Service  
Spruce, Mich.**

**Owners:** Lynn and Richard Gillespie  
**Founded:** 1997  
**Employees:** 2  
**Service area:** 50-mile radius  
**Specialties:** Pumping, portable restrooms, and troubleshooting systems  
**Associations:** National Association of Wastewater Transporters Inc., Michigan Septic Tank Association



# Spreading the Word

**As Michigan pumpers adapt to major regulation changes, Alpena Septic Service works to build a favorable image for land application of septage**

*By Scottie Dayton*

**F**armers in northeast Lower Michigan watched Richard Gillespie of Alpena Septic Service grow corn and alfalfa on mediocre sandy loam soils after land-applying the wastewater he pumped. They couldn't raise those crops without using tons of costly nitrogen fertilizer and wanted to substitute some septage, but Gillespie turned them down. The demand far outstripped his supply.

Richard and Lynn Gillespie are pumpers who elected to stay on the land by building a septage storage facility that meets 2004 Michigan Department of Environmental Quality, or MDEQ, regulations. They joined the Michigan Septic Tank Association to have a voice in future septage regulations. Richard Gillespie is on the association's board of directors. "We want state legislators to understand that recycling wastewater benefits farmers and

lowers pumping prices for consumers," says Gillespie.

To emphasize his professional commitment, Gillespie became a NAWT-certified inspector and installer. Faced with a sluggish economy in the area, the couple found ways to grow their business through diversified services. Although Michigan's pumping industry is in transition, Richard and Lynn Gillespie are leading by example and ready for any challenges ahead.

**PIVOTAL YEAR**

Lynn Gillespie, who pumped septic tanks and portable restrooms for her father, opened her own business in October 1997 after she and Richard married and had customers before she owned a truck. They spent their honeymoon driving to New Jersey to buy a 1981 International vacuum truck with 2,800-gallon steel tank.

Believing portable restrooms could be profitable, they purchased 10 units in 2000. Richard



Richard Gillespie of Alpena Septic Service screens and stabilizes septic waste before taking it for land application. Inset, Lynn and Richard Gillespie with their Chevrolet 3500 and Mack Vision Series trucks. (Photos by Amy Lisenbe)



**"I TOOK THE NAWT INSTALLER CERTIFICATION TEST IN 2006, BUT THAT PIECE OF PAPER MEANS NOTHING HERE BECAUSE THE STATE DOESN'T REQUIRE ANY CERTIFICATION."**

**Richard Gillespie**



Lynn Gillespie (above) spools vacuum hose on her portable restroom service truck after cleaning a unit. At right, Roxanne Golder, who assists in portable restroom service, cleans a hand-wash station.



apply it, so we don't pump grease traps."

The rules also state that septage pumped within 15 radial miles of a DEQ-approved receiving facility must be discharged there. Beginning in the winter of 2007-08, it became illegal to apply septage during a winter period set by the state. No state allows farmers and haulers to apply septage or liquid manure if the soil is frozen, but Gillespie argues that

Gillespie built a folding hydraulic platform on the back of the vacuum pumper to transport them. He coupled a 2-inch hose to the 3-inch sewage hose so his wife could reach and clean the restrooms.

While Gillespie built homes and did excavating, she pumped tanks and portable restrooms in a 50-mile that included Alpena, Alcona, Montmorency and Oscoda counties. In 2004, he joined the business, becoming a NAWT-certified pumper. His ability to troubleshoot systems soon earned him the nickname Septic Doctor.

The couple began enlarging their portable restroom inventory in January 2004. Lynn Gillespie spent months calling special event organizers, township park departments, and building contractors. "That spring, we had more business than potties," she says. They

purchased 20 Aspen units from Five Peaks Technology and 80 Taurus and eight World Care handicap units from Synergy World. Lynn Gillespie's sister, Roxanne Golder, helps her service them.

#### **DISPOSAL CHALLENGES**

Alpena Septic's pumping accounts are 85 percent residential and 15 percent commercial. The latter are all restaurants, mostly with commingled septic systems. The area has primarily cottage industries with many seasonal dwellings near Lake Huron.

"Everything changed when the MDEQ revised septage disposal regulations became law in 2004," says Richard Gillespie. "They greatly restrict what haulers can do. For example, we can't pump car washes unless we have an industrial waste-hauling license. We must commingle two-thirds septage with one-third grease trap waste to land-

soil is often insulated by snow cover in the winter, preserving favorable conditions for injecting septage.

"With the soil often well above freezing, it's radiating heat and melting the snow," says Gillespie. "Injecting septage prevents runoff and erosion. The liquid still seeps down and the soil treats it. Injecting also builds up organic matter and creates structure, which further reduces runoff and erosion. Our association is trying to help the MDEQ understand those scientific principles."

Haulers without storage facilities had to stop pumping or discharge at municipal plants, forfeiting their land sites in the process.

#### **ROLLING THE DICE**

In 2007, the couple made a financial commitment and purchased a glass-lined, 100,000-gallon steel storage tank from Slurry Store Co. It can be expanded to 300,000 gallons by building up the sides. A mandatory bar screen with 3/8-inch gaps separates debris from the septage.



Richard Gillespie applies septage on one of the company's sites (above). At right, Gillespie checks a valve on the company's new 100,000-gallon Slurry Store Co. steel storage tank in Spruce, Mich.







Above, Lynn Gillespie services a handicap restroom at a park in Alpena while Roxanne Golder stows service accessories. Alpena Septic services many city parks during the busy summer season. At right, Gillespie pumps a unit.



A time limit made the venture risky. As long as their storage facility or plans to build it were approved before the municipal plant in the area was ready to accept septage, the couple could land-apply until 2025. "We began planning our facility in 2004, had the plans approved at the local level in 2005, then waited to see what happened," says Gillespie.

The nearest treatment plant in Oscoda, 32 miles away, didn't accept septage until 2006. The City of Alpena's updated treatment plant will come online sometime in 2008, but officials aren't stating the discharge fee.

In 2006, before the Oscoda plant began

accepting septage, the MDEQ approved the plans for Alpena Septic Service's storage facility. The Gillespies built the facility themselves.

As soon as haulers gave up their land sites, the plant south of Alpena raised its discharge fee from \$55 per 1,000 gallons to \$80 in 2007. It increased to \$110 per thousand early this year. "Treatment plants have realized the revenue that's out

there and are increasing their rates so they will have ample money to modify their facilities to accept septage," says Gillespie.

Haulers are passing those rate hikes onto customers. Gillespie estimates that it costs him less than \$35 a thousand to dispose of his septic waste. This price discrepancy has created cutthroat competition for the region's meager customer base.

## RISING FEES

Because the area is economically depressed, analyzing competition is based on population. Alpena County, with 30,000 people, has four haulers. Alcona County, with 10,000 people, has three haulers, two of which discharge at municipalities. Alpena Septic Service is probably the second largest company in the region.

The couple land-apply on a 130-acre site and a 40-acre site. Gillespie would like to accommodate more farmers, but can't afford the \$500 permit fee per site. "My hauler's license increased from \$125 a year to \$1,600 in 2006," Gillespie says. "The state charges more per vehicle if you land-apply."

The law states that haulers are responsible for what happens to the septage, and that it must be incorporated within six hours of being applied unless it is lime stabilized. Rather than rely on a farmer, the couple bought a disk, springtooth harrow, and John Deere tractor to incorporate the slurry. Gillespie adds lime to the storage tank to stabilize the slurry, enabling greater surface application on alfalfa fields. He pays a man to plant his corn. Controlling farm operations has proven very time consuming for Gillespie.

## OUT IN FRONT

One investment that is paying off is the 2002 Mack Vision Series vacuum truck they bought in 2006 from 27th Trucks Inc. The couple can transport more waste and the fuel economy is better than on the smaller International. The Mack sports a 460-cubic inch E/7 engine coupled with a 10-speed Eaton-Fuller transmission. It has a 4,200-gallon steel tank and Jurop 150 water-cooled pump. A drop axle allows hauling a minimum of 1,500

Lynn Gillespie uses a Caterpillar loader at one of two Alpena Septic disposal sites.



Richard and Lynn Gillespie load vacuum hoses back onto their Mack Vision Series truck after pumping a residential tank in Spruce, Mich.



gallons when spring weight limits are enforced. As an advertising vehicle, the truck is helping increase their customer base. "Everything we own is painted metallic forest green and white," says Lynn Gillespie. "People identify the company by those colors." Answering calls on weekends and word-of-mouth references are other ways they compete for business.

Providing quality service — doing things other pumpers don't do — is another way the couple is expanding their customer base. As a NAWT-certified inspector, Richard Gillespie is trained to look for many different things. "I often won't pump the tank if other issues are causing the problem," he says. "I alert the homeowner and fix what is wrong. Although the process is slow, these people do become my customers."

Besides troubleshooting, Gillespie also replaces lines and installs risers and effluent filters. He has time to install only 20 onsite systems a year. Inspecting systems accounts for 10 percent of the company's profit.

Another way the couple increases its customer base is by educating homeowners on how to maintain septic systems. Besides golden backyard opportunities, they rent a booth at an annual home show, where Richard Gillespie presents a program on operation and maintenance.

"People are starving for the information. After Richard's session, many in the audience follow him back to our booth. Most become our customers," says Lynn Gillespie. The couple ordered educational videos from the Pennsylvania Septage Management Association and shows them at the booth. "People actually sit and watch them," she says.

### STANDARDIZING THE CODE

Richard Gillespie says that the biggest challenge facing haulers is establishing a standardized septic code. "We have about 80 different sets of rules throughout the state," he says.

Developing a state certi-

fication program is the next hurdle. "I took the NAWT installer certification test in 2006, but that piece of paper means nothing here because the state doesn't require any certification," Gillespie continues.

The Gillespies remain committed to staying on the land, recycling waste responsibly, and working to make legislation more amenable to haulers. The next phase of their growth plan is to hire a full-time employee. "Taking some time off after years of working around the clock will make a huge difference in our lives," says Gillespie. "We'll finally be able to enjoy the fruits of our labors." ■

## Just call him the Septic Doctor

Richard Gillespie of Alpena Septic Service in Spruce, Mich., knows so much about troubleshooting onsite system problems, septic customers now refer to him as the Septic Doctor. The National Association of Wastewater Transporters Inc. certified inspector has run into some interesting case studies in recent years.

His most bizarre case involved a homeowner who had his septic tank pumped every two years, yet one day it backed up. The man showed Gillespie a 6-inch cleanout port in the garage floor, but the liquid he examined was effluent water. "We have a lot of dry wells in the area, and this is what the hauler had been pumping," he says.

Gillespie couldn't use his electronic locator to find the septic tank because the lateral was plugged and the house had no cleanouts. He and his wife, Lynn, a septic hauler, excavated beside the two-car garage and used long probes to calculate measurements. They chalked the tank's projected location on the garage floor, then sawed out a 24-inch-square concrete slab.

"To our amazement, we hit the cover," says Gillespie. "We were off center by 3 inches, but were able to remove the lid and pump the tank for the first time in 13 years." Gillespie installed a riser and replaced the slab. Since the system wasn't up to that health district's code, the homeowner was told to replace it.

A recent episode involved a lake home with a wrap-around deck. An inspector had passed the onsite system two years ago when the property was sold. Now sewage was backing up. When Gillespie arrived to pump the tank, he couldn't find it. "The soil is glacial till — boulders, stone, and clay — and it's impossible to stick a probe in the ground," he says. "It's hard to dig even with a backhoe."

Gillespie sent his sonde down the toilet and found the tank buried beneath the deck. "It was quite a battle to uncover it, because the deck's structural supports were over the lid," he says. "No one had pumped that tank in years. The inspector had charged the homeowner for pumping what he stated was the required two-compartment, 500-gallon tank. Gillespie pumped the tank and estimated its capacity at 300 gallons.

When he flushed the toilet, water flowed into the tank, but nothing happened when he flushed the second toilet. Sending down the sonde, he found another 300-gallon tank 60 feet away on the opposite side of the house. The deck's structural supports were over that lid, too.

"Nothing in this system would have passed the local health district's sanitary code," he says. "Sadly, such inspections are common in Michigan." The homeowner spent \$5,000 bringing his "passed" system up to code.



Richard Gillespie makes sure the dosing valves are sequencing correctly at a municipal system. The electrical panel is solar powered.



Gillespie places a temporary filter at a municipal onsite system as he prepares to clean the system's permanent Zabel effluent filter. Richard Somers, Lincoln Village street supervisor, looks on.

### MORE INFO:

**27th Trucks Inc.**  
305/835-9030  
www.27th-trucks.net

**Five Peaks Technology**  
866/293-1502  
www.fivepeaks.net

**Slurry Store Co.**  
815/756-1551  
www.slurrystore.com

**Synergy World Inc.**  
800/352-1986  
www.portabletoilet.net





# DRAGON

PRODUCTS, LTD.

PUMPS DIVISION

*A Modern Group Company*



Custom fabrication to meet our customers specific needs in the Petrochemical, Shipping, Drilling, Agricultural and Mining industries. All Dragon pumps, agitators, hoppers and pump packages are assembled in Liberty, Texas.

All internal pump parts such as bearings, shafts, and mechanical seals are from the highest quality parts and materials made in the USA.

We also maintain a huge warehouse of motors by Baldor and Reliance and starters by Sprecher & Schuh/Allen Bradley.

We also have a full stock of replacement parts for your pumps which are 100% interchangeable with other popular pumps on the market. We are also the largest stocking dealer of **Fruitland Pumps and Parts** in the U.S.A.

  
**Louisville 2008**  
Come see us at Booth #7081



**1-866-914-8198**

email: [sales@modernusa.com](mailto:sales@modernusa.com)

website: [www.modernusa.com](http://www.modernusa.com)



# DRAGON PRODUCTS, LTD.

A Modern Group Company

150 BBL ALUMINUM &  
130-160 STEEL CODE  
AND NON-CODE  
VACUUM TRAILERS

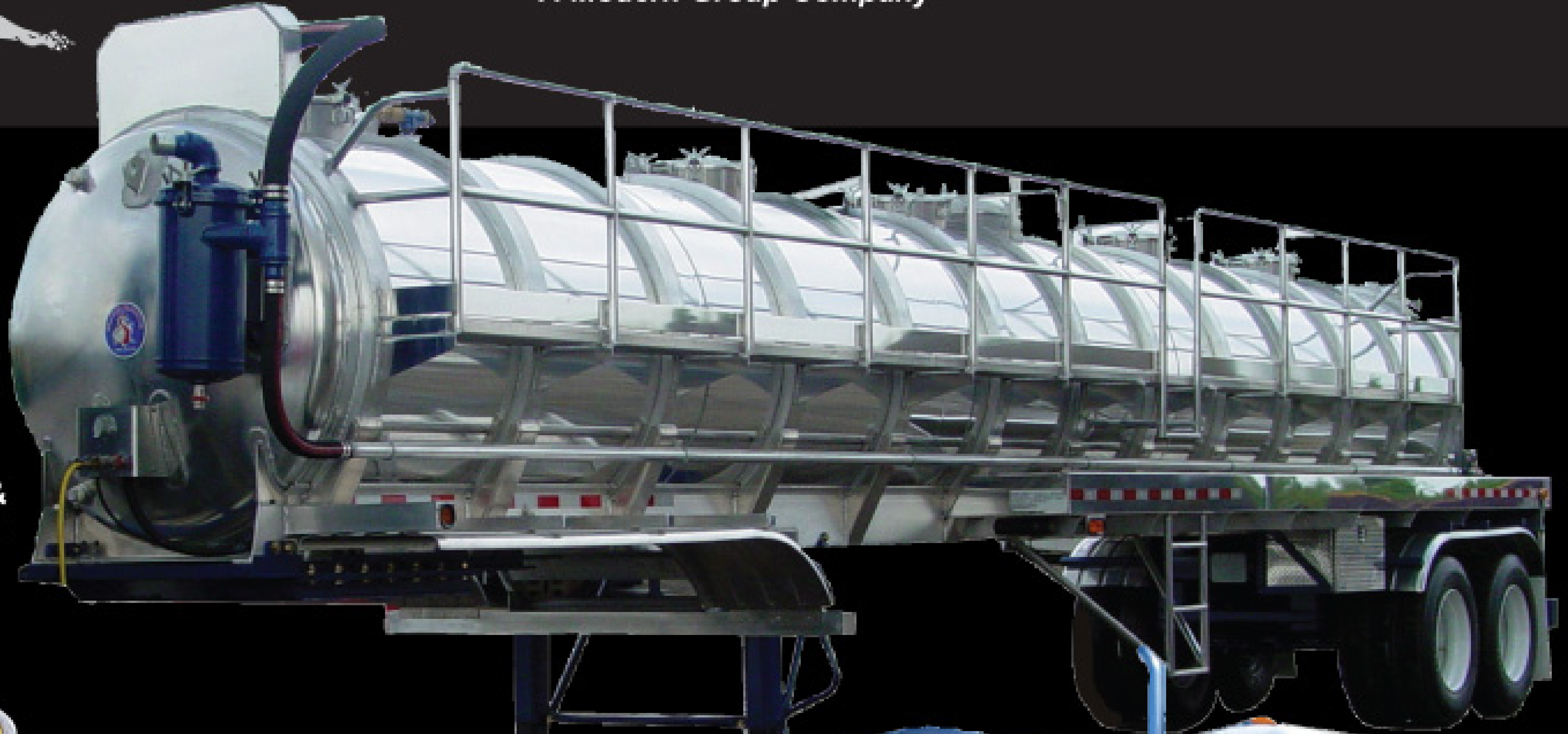

30-80 BBL STEEL &  
ALUMINUM BOBTAILS



SINGLE & TWO CONTAINER  
ROLL-OFF TRAILERS



**Louisville 2008**  
Come see us at Booth #7081

VACUUM  
ROLL-OFF  
CONTAINERS



500 BBL LIQUID TIGHT  
SMOOTH WALL CONTAINERS

Looking for a Great Deal on Quality  
Used Equipment?  
Check out our web-site at:  
[www.modernusa.com](http://www.modernusa.com)

# (877)778-4280

email: [sales@modernusa.com](mailto:sales@modernusa.com)



Ask about our easy  
Credit Terms and  
Convenient  
Financing.



# Don't Go In Without The BLUE



## DEEP BLUE™

A Complete Odor Control & Cleaning Program  
from Nilodor®, Inc.

- Additives
- Super Concentrates
- Deodorizers
- Cleaners
- Graffiti Remover
- Hand Sanitizer
- Hand Soap



Controlling Unwanted Odors For Over 50 Years

**NILODOR®**  
Inc.

P.O. Box 660 Bolivar, Ohio 44612

**800-443-4321**

**www.getdeepblue.com**



Amthor Matador

We're proud to be an official distributor of



aluminum, steel and stainless steel vacuum tanks.



(888) 204-7872

www.stuarttank.com

Call TODAY for immediate delivery.

940 East Geneva Street PO Box 558  
Elkhorn, WI 53121



#11044 & 11045

# Come In We're

# PREP

www.pumper.com

# \$ WE'VE GOT THE MONEY \$

## For All Your New and Used Equipment Needs

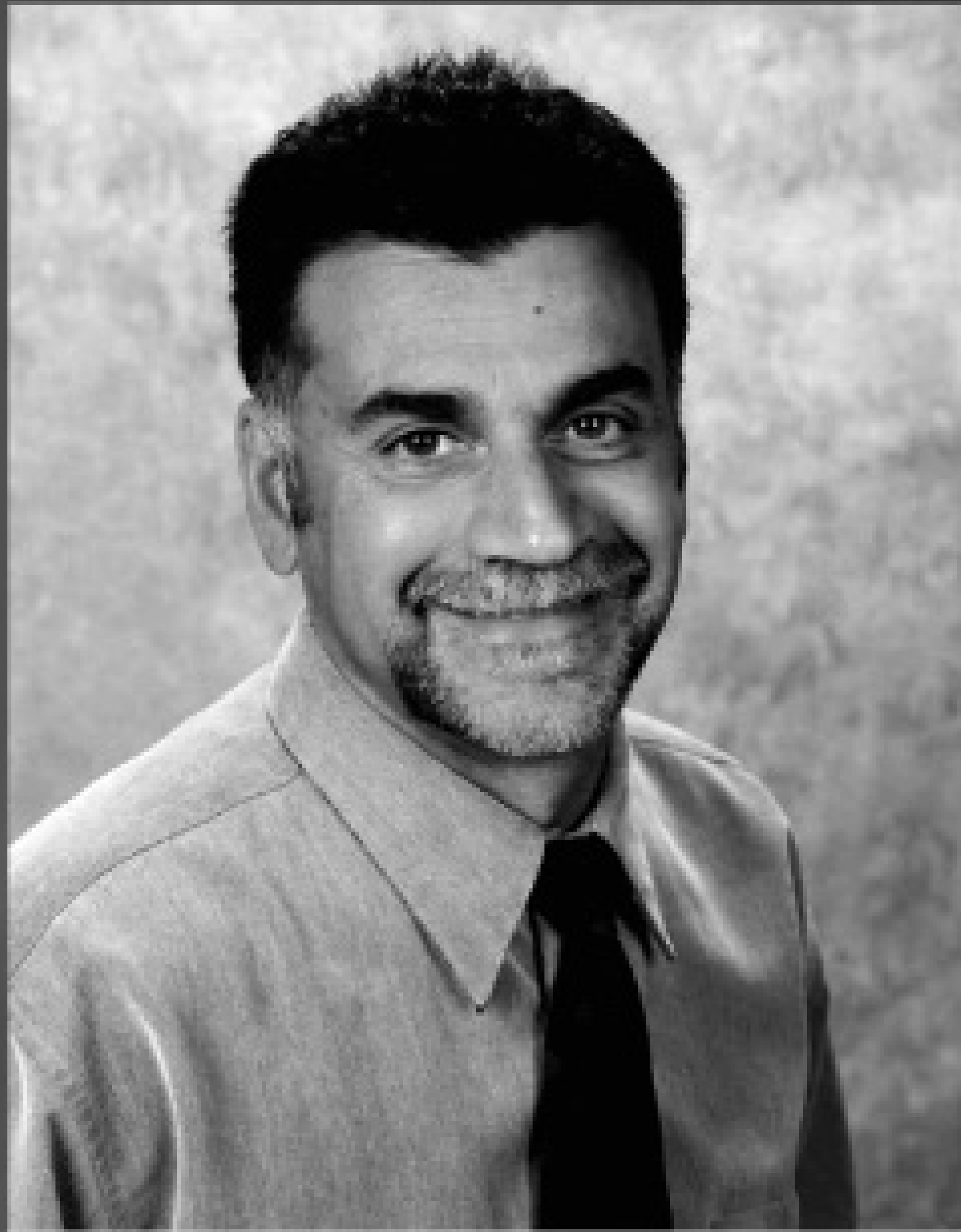

**CHUCK TERRITO**

- > APPLICATION ONLY TO 250K
- > SIMPLE APPROVAL PROCESS
- > LEASE OR LOAN OPTIONS
- > NEW & USED EQUIPMENT
- > FLEXIBLE FINANCE OPTIONS
- > START UP PROGRAMS



**MIKE RAUSCH**



Come visit us at  
**Booth 7104**

Fax this E-Z application to **406.892.5072**, or give us a call, and we will get your financing approved for the show.

Company Name: \_\_\_\_\_ Owner/Contact: \_\_\_\_\_

Address: \_\_\_\_\_

City: \_\_\_\_\_ State: \_\_\_\_\_ Zip: \_\_\_\_\_

Phone: \_\_\_\_\_ Best time to call: \_\_\_\_\_

**Let us put our 35 years of experience to work for you!**

**Call today and see why...**

***IT PAYS TO LEASE WITH US!***



**800.246.7997**  
**www.graniteleasing.com**



# CLEAR COMPUTING *with* INSIGHT

**Total Activity Control**

**Street Eagle GPS Tracking**

## TACTrackerPRO



- Vehicle Tracking
- Service Verification
- Production Reporting

See Us at  
Booth 3173

**Clear Computing**  
(888) 332-5327

[www.clearcomputing.com](http://www.clearcomputing.com)



**Insight USA**

(301) 866-1990 x201

[www.mds-inc.com](http://www.mds-inc.com)

### TO DO THE BEST JOB, YOU NEED THE RIGHT EQUIPMENT

**Liquid-Cooled Vacuum Pump**  
5 Models Ranging from 530-1883 cfm

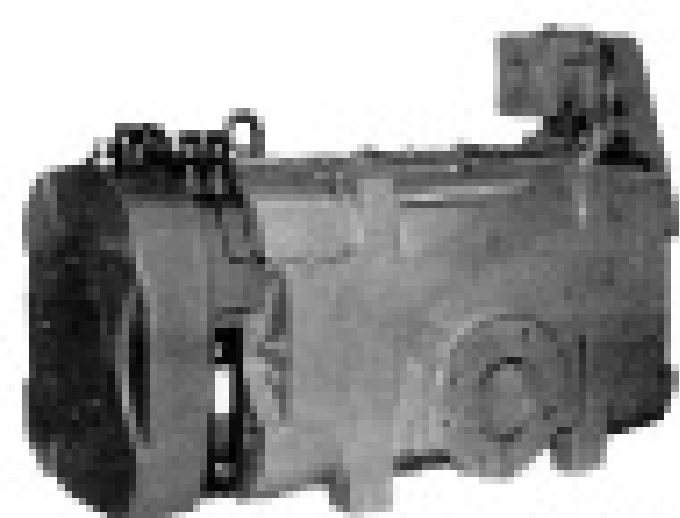

When You Really Have to Get to the Bottom...

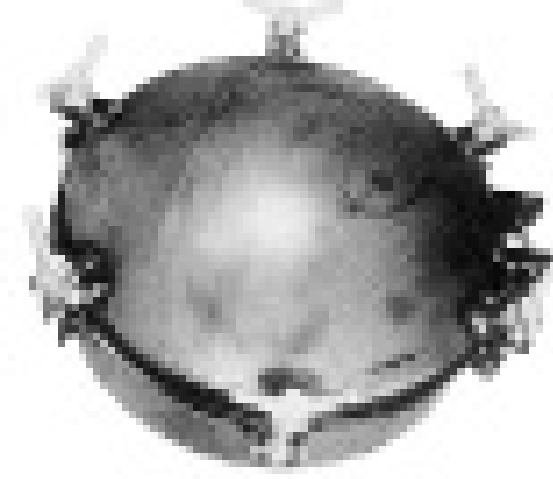

Manways  
12", 17", 21", 25", 36"



Sight Glasses



Angle Gearbox

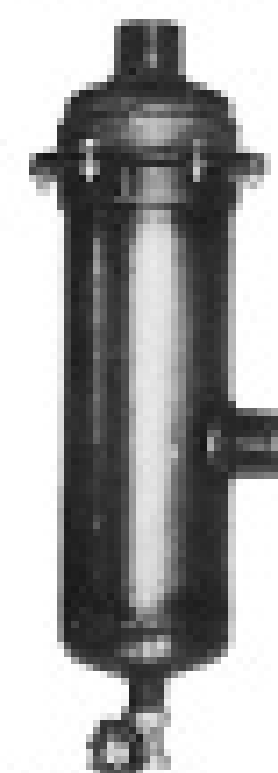

Secondary Checks



Brass Ball Valves  
2" #35  
3" #115  
4" #165

**NVE**

Corporate Office  
1-800-243-7986

Want That Extra Edge From Your Vacuum Truck?

**utile vacuum pumps**



**LW 625 [393cfm]**

**LW 825 [535cfm]**

- 27" Continuous Vacuum
- 35 psig Discharge Pressure
- 800-1100 Operating Speed
- Completely Self-Contained
- Fan and Ballast Port Cooling

Designed with Quality, Built for Performance, A Generation Ahead

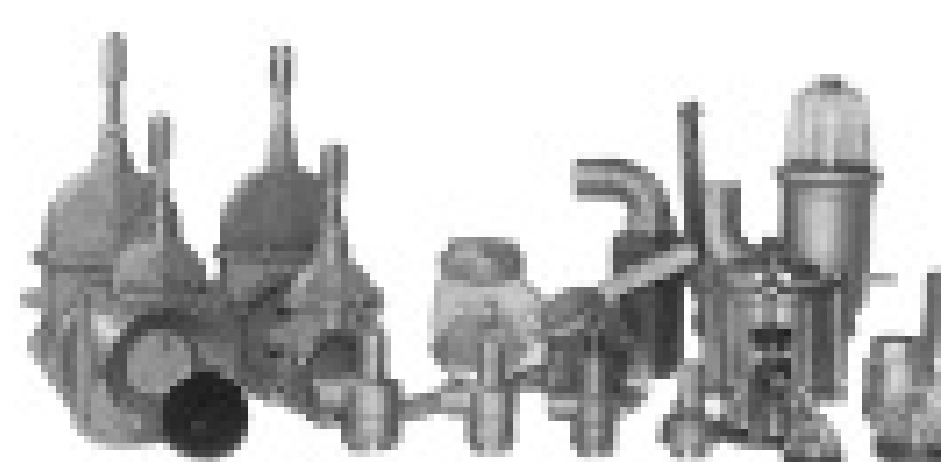

**jurop**

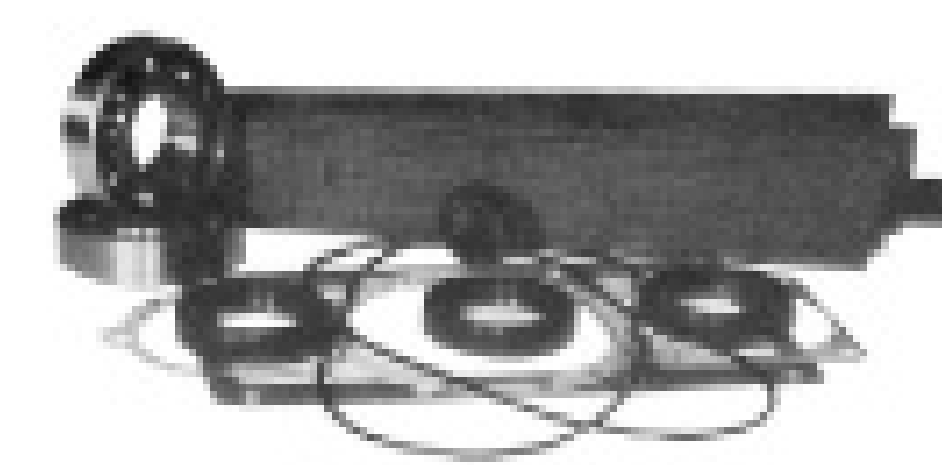

Pump Service and Repair Kits  
(Most Major Mfg's.)

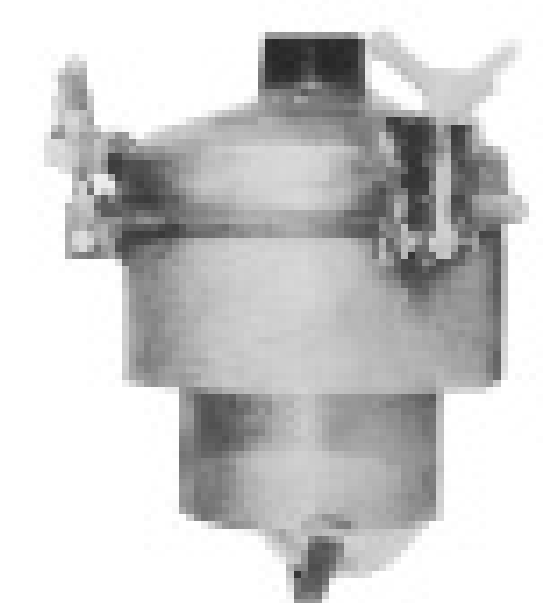

Portal Shutoff

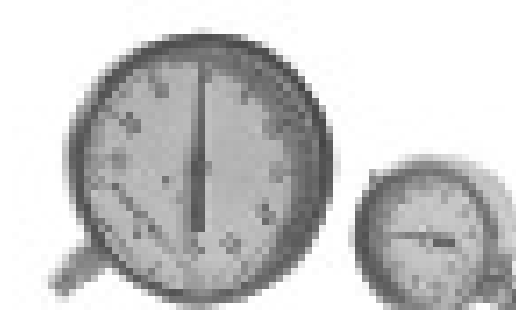

Vacuum Gauges

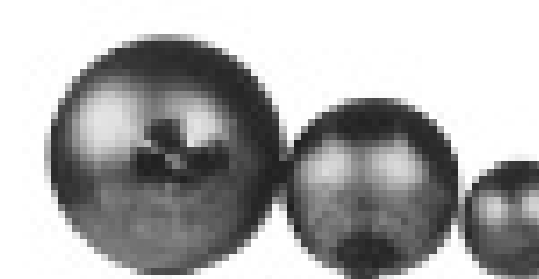

Stainless Steel  
Float Balls

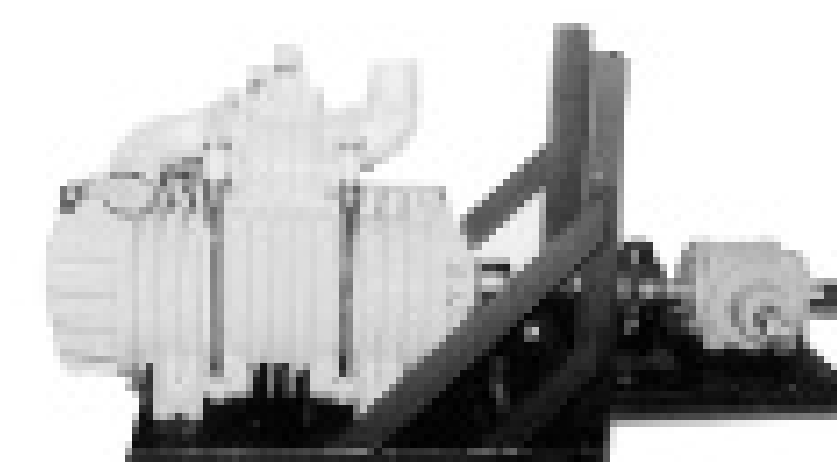

Pump and Gearbox Frames



Betts Valves



Oil Catch  
Mufflers

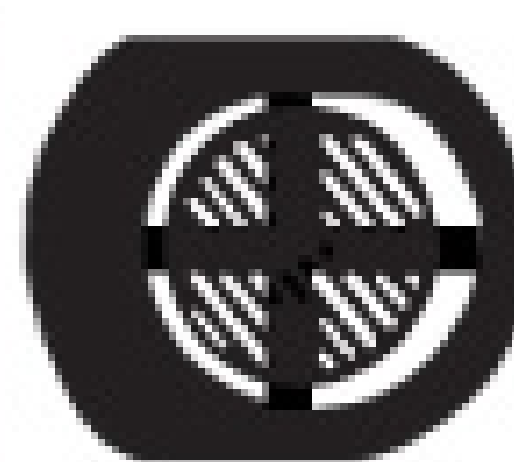

**COM VAC  
SYSTEMS**

Southern Sales  
1-800-346-7789

**Masport**

# Mobile Dewatering Systems by BDP

## Advantages of the BDP Model 3DP Belt Press mobile dewatering system:

- Independent Gravity Zone at waist level when installed on the trailer, easily observable by the operator
- Elevated cake discharge. Discharge directly into the truck or dumpster, no dumping on the ground and additional conveyors or loader are needed.
- Ease of accessibility for maintenance



**H&A Resource Management**  
Versailles, KY Tel: 859-873-3331



**MSD Environmental**  
Centerville, OH Tel: 937-313-9314



**Thunder Bay Casino**  
Sacramento, CA Tel: 209-483-4118

- Tubular frame (*right*) provides a flat surface with fewer corners and ledges. Clean up is easier, with less corrosion.
- Process performance exceeding any other manufacturer: highest liquid flow rate, highest cake solids, lowest polymer usage.
- Lowest maintenance cost and significantly lower down time for maintenance.



BDP Industries, Inc. will provide a complete custom dewatering system package, wired and plumbed with foldout walkways, area heaters, and controls.

Visit us at Booths 7006-7009 at the  
**2008 Pumper & Cleaner Expo**

## Industry References:

Synagro Inc.  
MSD Environmental  
Blue Heron

Parker Agg  
LWI, Inc.



BDP Industries, Inc. 354 Route 29 Greenwich, NY 12834 Tel: 518-527-5417, Fax: 518.695.5417 Email: Kelly@bdpindustries.com  
[www.bdpindustries.com](http://www.bdpindustries.com)



# TankTec

Tank Technologies & Supply Co. LLC

Portable  
Restroom  
Service Trucks  
Septic, Grease & Grit Trucks



## 2008 Kenworth T300 2800 Gallon

From **\$88,900** plus FET  
33,000 Lb GVW • 6-Speed • 260 HP  
Masport HXL15 350 CFM • Toolbox  
Lease from \$1220/Month



## 2007 Chevy 7500 2200 Gallon

From **\$78,900**  
Auto Trans • Air Brakes  
MORO PM80 360 CFM  
Lease from \$1500/Month

Many Other Options Available such as:

- Pump options, including Blower Pumps
- Chassis options
- Lift Tanks
- Rear Opening Doors
- Multi-section Tanks
- Jetters
- Custom Inlet/Outlet options

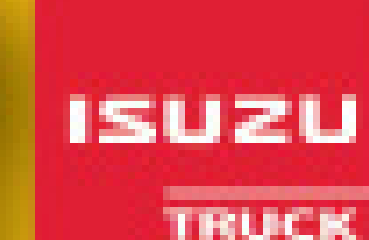
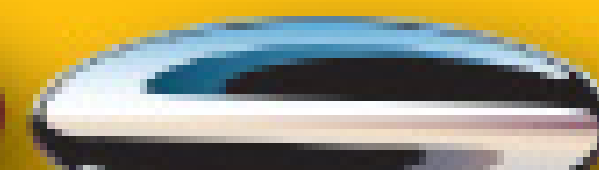
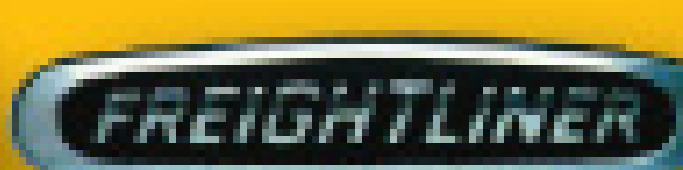



Booth 4133

# 888.428.6422

## 2008 Kenworth T300 1700 Gallon

From **\$73,900**

22,000 lb G.V.W. - Non-CDL  
Cummins Diesel • Hydraulic Brakes  
Allison Automatic • A/C • AM/FM  
Aluminum Cab  
Lease from \$1050/Month



Standard PRS Features:  
Masport HXL4V 160 CFM  
Vacuum Pump System  
Burks DC-10 Water Pump  
Fold Down 2 Toilet Hauler  
2 Large Work Cabinets

## 2007 Chevy 5500 1250/1500 Gallon

From **\$67,400**

4x4 from \$77,095  
Lease from \$1340/Month



## 2008 International 4400 810 Gallon Combo

From **\$87,900**

540/270 Tank Split  
Elec/Hyd Liftgate  
Dual Side Service  
12' Bed • 26,000 Lb GVW  
Lease from \$1700/Month



12' Bed

Ask About In Stock Trucks • Call for Lease Payment Details  
Tanks in Stock • Financing and Leasing Options Available • Dual-Use Options  
Customize to Your Needs • PRS 800-2500 Gallon • Vacuum 1000-6000 Gallon



**Tank Technologies & Supply Co. LLC • 888.428.6422 • [www.tanktec.biz](http://www.tanktec.biz)**  
Steve Nelson • [snelson@tanktec.biz](mailto:snelson@tanktec.biz) Local • 763.755.8075 • Fax • 763.757.9788  
Andy Nelson • [anelson@tanktec.biz](mailto:anelson@tanktec.biz) 10100 Quinn St. NW, Minneapolis, MN 55433



# A Suction Scare

**“I don’t care how strong you are, once a vacuum hose seals on you, you’re not going to pry it off.”**

**R**esource Geoscience Inc. in Colorado Springs, Colo., specializes in environmental assessment, compliance, and remediation services. One contract involves cleaning guano, half-dead pigeons, and maggots from the roofs of car washes and service stations before the debris clogs gutters. Besides harnesses and hard hats, the men wear full Tyvek suits and full face respirators because of the health hazards associated with pigeons. Suit sleeves are duct-taped around surgical-type gloves, followed by removable rubber.

it. In a millisecond, the flexible hose engulfed his entire arm, which immediately began to hurt. The terrible sound of silence followed as the hose sealed itself around his arm and chest.



**MY BODY RESPONDED FASTER THAN MY BRAIN ... EVEN THOUGH WE WORKED SHORT SHIFTS, THE HEAT COULD HAVE AFFECTED MY THINKING ... I PROBABLY COULD VACUUM PIGEON DEBRIS ANOTHER THOUSAND TIMES WITHOUT INCIDENT, BUT THIS TIME A LINK BROKE IN THE SAFETY CHAIN.**

**Tom Lewis**

**Pumper:** What makes the whip hose different from other vacuum hoses?

**Lewis:** It’s a plastic, flexible, corrugated hose used around French drains, houses, or downspouts. It wears quickly if you’re vacuuming metal or rock, but we just replace it because it’s cheap. It’s super light so it moves easily. The bad thing about the whip hose is once it goes under full vacuum, it collapses and shortens, whereas most vacuum hoses don’t collapse. Our normal 6-inch hose is so big and heavy that we can’t move it.

**Pumper:** What procedures did your employees follow in this emergency?

**Lewis:** The spotter standing beside me saw that I was in trouble and signaled to the operator by line of sight to shut off the truck. It probably took 10 to 15 seconds from the hose grabbing me to the vacuum releasing, but it felt like an eternity.

The pain was incredible.

When my guys ripped open the suit, we didn’t see any blood, just my horribly swollen arm. They immediately wanted to take me to the hospital, but I didn’t think I was hurt that badly and refused to listen. I then realized that, as owner, setting a good example was my responsibility. If someone has an accident, big or small, he should see a doctor. It’s important. The emergency room staff told me that their concern was possible blood clots.

For two hours after the accident, the pain was incredible due to the swelling. Weeks later, it was still hard to sleep because of the pain.

I was just lucky. I calculated the force exerted on my arm to be about 300 pounds. I

don’t care how strong you are, once a vacuum hose seals on you, you’re not going to pry it off. The accident reinforced the importance of having a spotter whose only job is to watch what’s going on and be ready to react.

**Pumper:** Are you an experienced vacuum truck operator?

**Lewis:** I’ve been out on these vac trucks for years, but am not a primary operator. I’m an engineer, so I tend to be a helper. I like switching between paperwork and providing service. We handle a lot of emergency response and industrial vacuum projects. Some big efforts require putting everyone in the field. However, Resource Geoscience has only 12 employees, six of whom are full-time field crew, so all office personnel except the draftsman and secretary are 40-hour OSHA (Occupational Safety and Health Administration) trained, too.

**Pumper:** How does your safety program function?

**Lewis:** I’m the one who normally gives safety training on the projects I manage. We have a specific health and safety plan for each site that includes the location of the nearest hospital and the hazards. Everyone goes through refresher courses each year. We’ve had hundreds and hundreds of hours using the whip hose, even inside tanks in the dark, without incident. This is the closest we’ve come to a big disaster.

**Pumper:** Did you become complacent to the danger?

**Lewis:** I think that’s what happened, and trying to catch the glove was an instinctive reaction. My body responded faster than my brain. It was hot; I couldn’t see. Even though we worked short shifts, the heat could have affected my thinking. All that safety gear restricted my mobility, too. I probably could vacuum pigeon debris another thousand

## Pumper Interview

By **Scottie Dayton**



Tom Lewis (left) holds an on location safety meeting with his crew, (from left) Al Comer, Darrell Robbins and David Comer. The truck in the photo is the King Vac from Keith Huber Inc. that was in use when Lewis was injured. (Photos courtesy of Tom Lewis)

Owner Tom Lewis and crew were cleaning guano one 80-degree day using a King Vac industrial vacuum loader from Keith Huber Inc. At that altitude, the machine produces 3,700 cfm with 22 inches mercury instead of the standard 27 inches. Lewis, who stands 6-foot, 1-inch tall, weighs 185 pounds, is 47 years old, climbs mountains like Everest and Kilimanjaro, and works out daily in the gym, was handling the 6-inch diameter whip hose.

Perspiration streamed down Lewis’ face shield, impairing his vision. As he reached down to move the hose to another pile of debris, the vacuum began sucking off his left-hand glove. Instinctively, Lewis made a fist and moved his hand toward the glove to catch

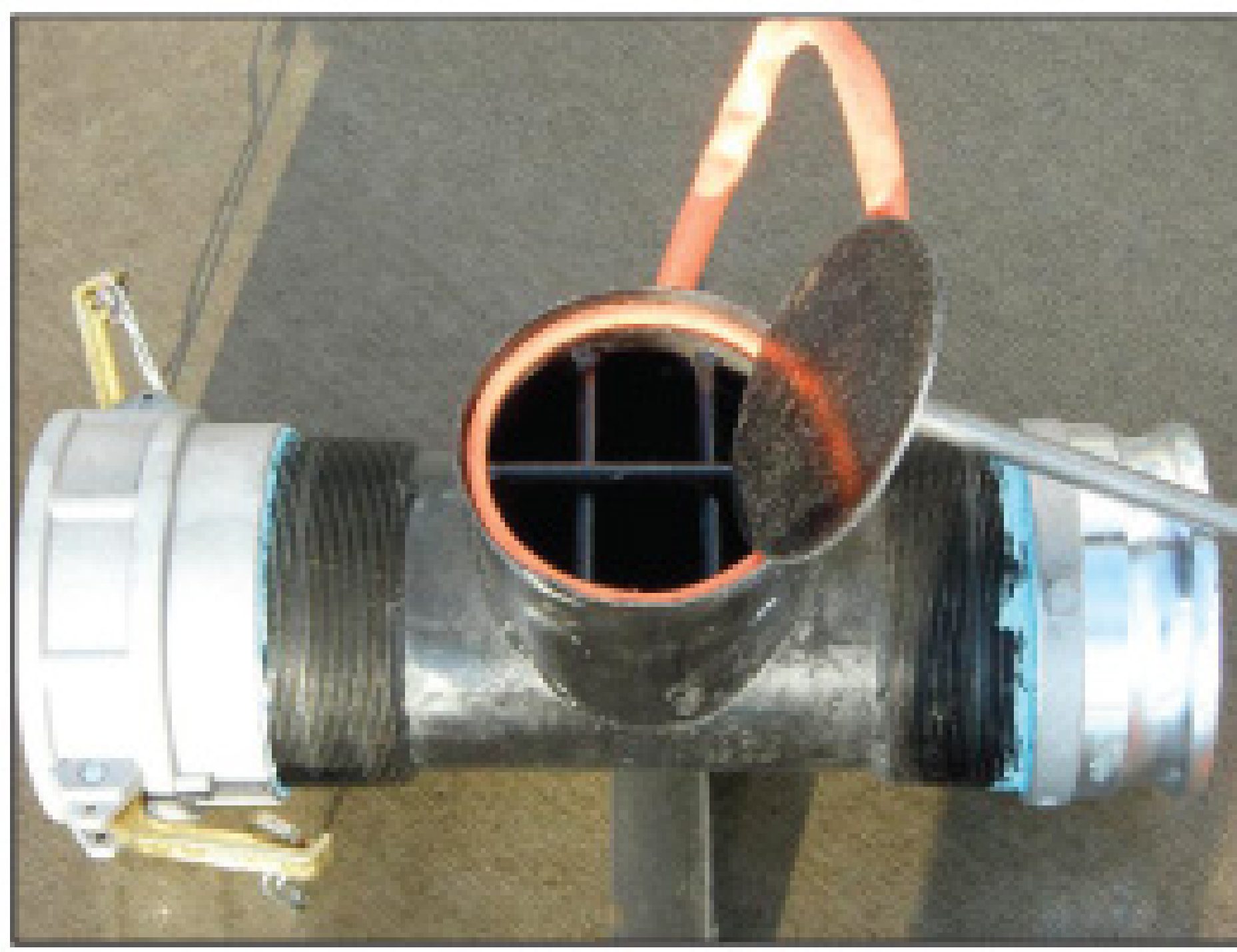

This is the safety tee Lewis purchased for the King Vac truck after the near-miss injury incident. He ordered it from Environmental Products & Accessories, Hixson, Tenn.

times without incident, but this time a link broke in the safety chain.

**Pumper:** Did you consider it an unusually difficult job?

**Lewis:** It was difficult. A different crew had been on the project three days, then we were called in to relieve them. We had plenty of time and didn't feel rushed, but wanted to finish the job because it's so hard.

I started out refreshed, but after 10 minutes working in that heat all suited up, I began to feel it. However, I believe complacency

more than fatigue caused the accident. Thankfully, our safety procedure worked properly. Without a spotter, I would have been in big trouble. The accident wasn't a recordable incident or a lost time injury. It was a near miss.

**Pumper:** How has the near miss affected your safety program?

**Lewis:** Our safety program will remain the same, but we'll focus on how to prevent a repeat of the accident. We will look closer at what we learned five or 10 years ago and maybe forgot. Besides our mandated annual refresher training courses, we go through eight-hour refreshers every year, and each job has a Toolbox safety meeting.

**Pumper:** What did the Toolbox meeting cover for the pigeon debris job?

**Lewis:** We talked heat, different shifts, do we have cell phone reception in case of an emergency, where is the nearest hospital, what vehicles are available if we have to transport, or do we call an ambulance. We discussed health hazards: is it respiratory, where is our line of sight, do we have traffic control issues, pedestrians, overhead hazards, slip-trip-fall hazards? Each worker signs and dates the site-specific health and safety plan for that

day. If we return to the project tomorrow, we do it all over again.

Everyone is medically monitored. We try to follow every OSHA procedure we possibly can. We're in a hazardous business. I should add that because our work is so diversified, we don't use the King Vac daily. We really need to revisit some things we learned about it when the machine arrived, because we probably have forgotten them. Everyone must understand the nuances of that truck.

**Pumper:** Did learning of your near miss have any negative effects on your employees?

**Lewis:** Actually, it's been a good thing in that it's created discussion. Almost every day we're getting together and asking, "What can we do to work safer? What other hazards are we not seeing?" The near miss raised everyone's awareness and made us more vigilant. We're trying to be super careful that such an accident never happens again.

**Editor's Note:** Lewis has since ordered and installed safety tees on his vacuum loading hoses. The operator can pull it to quickly release the vacuum. Another safety device, the Tip Top relief valve from Bandlock Corp., enables a rescuer to immediately release the vacuum when he hears the spotter's warning. ■



# CIRCLE D TRUCK SALES

[www.circledtruck.com](http://www.circledtruck.com)



VERY NICE!

**2008 OVERLAND 1308BL** New 1300bbl. (5460gal.) DOT 407/412. ASME Vacuum Trailer, Spring suspension, 11R24.5 tires, Full length walkway with handrails, (2) - 4" butterfly valves with air to open spring to close at rear, (3) - 20" diameter DOT certified National Vacuum domed man-ways, (1) 20" diameter DOT certified National Vacuum domed man-way located on lower rear head, 12" Heavy duty DOT internal shut-off at top front of tank, Outside scrubber with dome lid and 2" drain, Girard 3" relief valve, Front, center, and rear overturn protection, External arrow rotary float gauge with 6" stainless steel float ball, 18" x 18" x 36" toolbox with locking latch (2) work lights with on/off switch located at rear. **\$54,750**



12 IN STOCK NOW

(12) 2007 Troxell Vacuum Trailer, non-code, 1300bbl. (5,460 Gallons), 4 Spring Suspension, Steel Composition, 24.5 Tires, All Steel Wheels, Tandem Axle, 1 Compartments, Full length walkway with Tool box, (2) 4" butterfly valves, scrubbers, Full length hose trays. Ready to haul!!! FET Included in price, **\$43,1200**



NEW TANK

(2) 1998 MACK RB688S, E-7 Mack 350 HP, 9 Speed, Engine Brake, Camellback Suspension, 4.64 Ratio, 190" WB, 24.5 Tires, Aluminum / Steel Wheels, Tandem Axle, 12,000# FA, 38,000# RA, HD frame, AM/FM Stereo, P/S, A/C, New Chrome Bumper, (2) 80 Gallon Aluminum Fuel Tanks, Detailed And Serviced, New White Paint. "NEW" 2007 Bulldog Vacuum Tanks, 3,360 Gallons (80bbl), 1/4" Head & Shell Thickness, Primary & Secondary Shutoff, (2) Top Man Ways, (1) Rear Clean Out, (2) Internal Baffles, Sump With (2) 4" Rear Outlets With Wafer Style Butterfly Valves, Front Sight Glass, Vacuum & Pressure Relief Valves, Full Length Hose Trays, Rear Bumper, Jurop R260 Vacuum / Pressure Pump With Pump Stand And Right Angle Drive. Stk. #1487 **\$74,500 each**

Available Soon: 1992 Volvo w/Vactor unit, good spec's, being refurbished - Call for price!



VERY NICE!

2001 MACK CX613 VISION, E7-427 Mack, 10 Speed Autoshift, Engine Brake, Air Ride Suspension, 3.70 Ratio, 220" WB, 22.5LP Tires, All Steel Wheels, Tandem Axle, 500-600K Miles, Tilt, Cruise, AM/FM Stereo, Fleet Maintained, (2) 145 gal Aluminum Fuel Tanks, "NEW" 2007 Bulldog Full Tilt Vacuum Tank Hydraulic driven, Controls on driver side, 3,360 Gallons (80bbl), 1/4" Head & Shell Thickness, Primary & Secondary Shutoff, (2) Top Man Ways, (1) Rear oversized Clean Out air operated, (2) Internal Baffles, Sump With (2) 4" Rear Outlets With Wafer Style Butterfly Valves, Front Sight Glass, Vacuum & Pressure Relief Valves, Full Length Hose Trays, Rear Bumper, Jurop R260 Vacuum / Pressure Pump Hydraulic driven fan cooled. Stk #1790 **\$39,500**

MORE TRUCKS AND TRAILERS AVAILABLE, IF WE DON'T HAVE IT WE'LL FIND IT!

Lee Dill, Richard Roberts, John Trammell, Gary Chandler

CIRCLE D. TRUCK SALES

4502 E. OVERLAND TRAIL • ABILENE, TX • 79601

325-677-0474 • FAX: 325-673-7207

## 888-433-0474



4 IN STOCK

2005 MACK VISION CX613 "NEW" Presvac DOT-MC MC 412, 3150 Gallon, Tilt With Full Open Rear Head, 4" Load Line With Riser, 6" Discharge, Cabwalk With Handrails, Fruitland RCF 500 Vacuum Pump, Tilt, Cruise, AM/FM, Fleet Maintained, (2) Alum Fuel Tanks **\$135,000**



# Supplying your Business for Seasons of Success



new for 2006  
**TOICO  
Pump Trucks**



- **One-Stop Shopping**  
Our wide selection of products makes shopping at several different places for all of your needs a thing of the past.
- **Very Competitive Pricing**
- **Huge Selection**  
We carry a wide selection of portable restroom parts and accessories to take care of all your needs. Including toilet parts, pumps, pressure washers, hoses, valves, fittings, tank components, chemicals, dispenser systems, hand sanitizer, deodorizers and odor control products, engines, sink parts, cleaning supplies, and much much more.
- **Two Locations for Faster, More Economical Shipping**  
Our warehouses in Utah and Georgia are strategically placed to service every state.
- **Custom Pump Trucks**  
If you can imagine it, we can build it. We pride ourselves on our ability to work with our customers and design an efficient and effective pump truck designed around your custom applications.



**CALL TODAY for your  
FREE product catalog!**



"YOUR ONE STOP SOURCE"



Booth 2023

# 1-888-935-1133

[www.toico.com](http://www.toico.com)

YOUR ONE STOP SOURCE FOR PORTABLE RESTROOM PARTS AND SUPPLIES

# ROBUSCHI RB-DV Hi Vacuum Truck Blowers



Airflow range from 400 to 6,200 CFM  
Vacuum up to 28" Hg

- Robuschi Patented Air Injection Manifolds allow blower to operate at 28" Hg continuously without the need for a Vacuum Relief Valve
- Light Weight Patented Air Injection Manifolds and Low Pulsation Technology ensure lower noise attenuation and less vibration than competitors by 10 dBA.
- The fabricated and cast Air Injection Manifolds and Feet Assemblies can be custom made to suit PTO angle and lower blower between chassis rails as well providing handy lifting hooks for safe and easy assembly and removal.
- Rubber Mounting Feet included with the Custom Made Feet Assemblies ensure any Chassis Flex doesn't affect blower durability

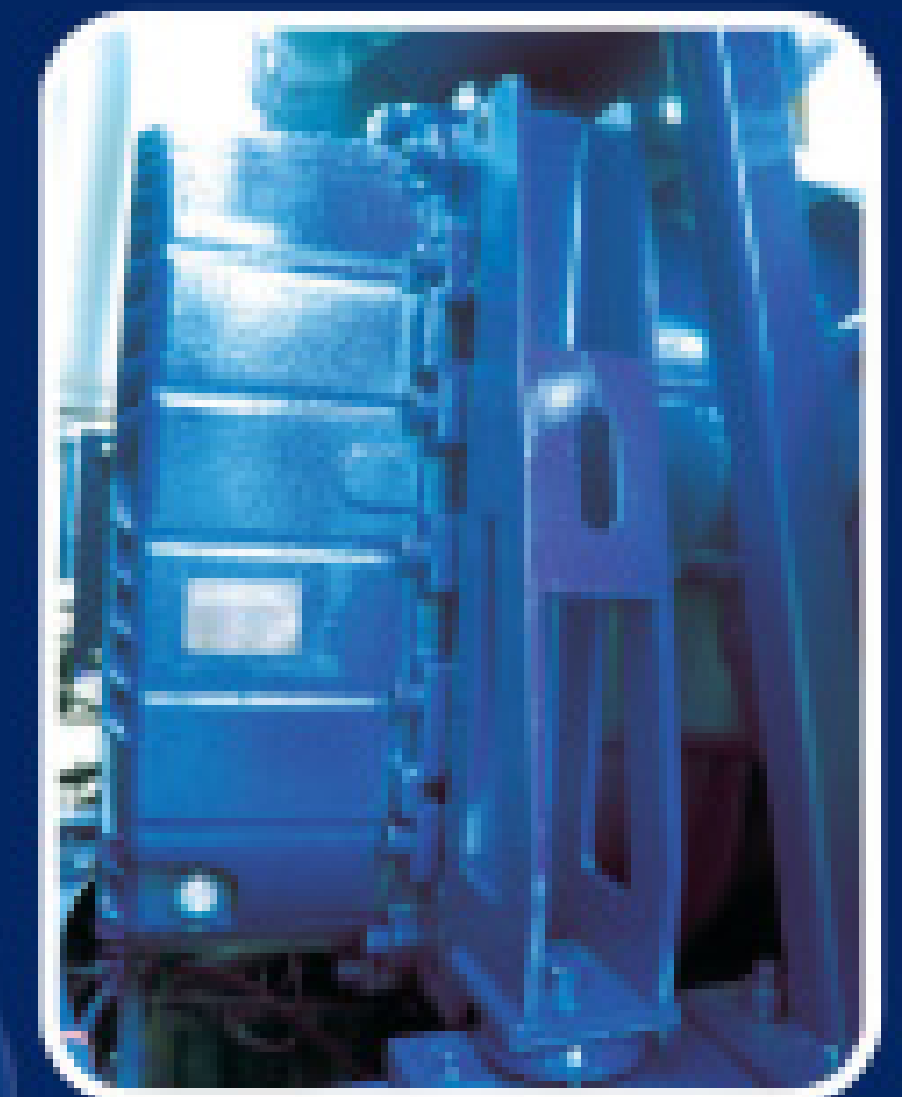

## ROBUSCHI®

U S A I n c.

Charlotte, NC 28217

Toll free: 877-424-1020

E-mail: sales@robuschiusa.com



Booth 8015

[www.robuschiusa.com](http://www.robuschiusa.com)



**Quality People Doing Quality Work**

**Industrial Vacuum Units**

*DOT Code & Non Code Vacuum Trailers*



**Vacuum Septic Units**

*Aluminum or Steel Tanks in a Variety of Capacities*



**Portable Restroom Service Units**

*IN STOCK - 650/300 gal.  
Call for Details  
Ready for Immediate  
Delivery -  
Priced at  
\$54,900*



**Mini Vac Trailers**

*DOT  
Code  
& Non  
Code*



**Slide-In Units**

*IN STOCK - Slide-In Portable  
Restroom Units - Call for Details  
Industrial Skid-Mounted Units  
Also Available*



**Marsh**  
**INDUSTRIAL**

P.O. Box 1107 - 135 E Mile Road - Kalkaska, MI 49646  
p: 231.258.4870 - f: 231.258.2019 - sales@marshind.com

**800.952.1537 - WWW.MARSHIND.COM**

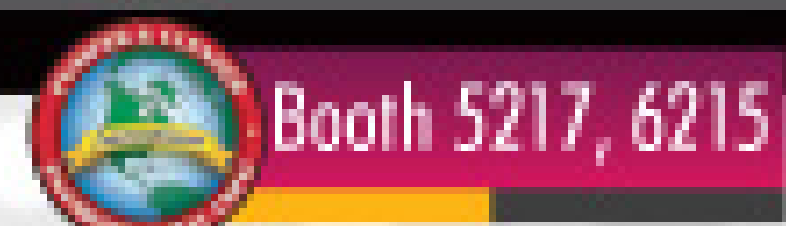

**Clearly,  
A Good Idea!**



**NO CONCEPTS**

**Solar Powered, Self-Contained,  
Special Event Restrooms**

[www.nuconcepts.com](http://www.nuconcepts.com)

**800-334-1065**



Booth 8191

**Happy New Year!**

**H&M**

**Vacuum Pumps  
& Equipment, Inc.**

Toll Free: **800-533-5858**  
[www.hmvacuumumps.com](http://www.hmvacuumumps.com)



**ONLY THE FINEST  
PRODUCT LINES!**



CHALLENGER • CHANDLER • CONDE • JUROP • MORO • NVE • ROBUSCHI • THOMPSON TANK & UTILS

**PROVIDING SERVICE WORLDWIDE - CALL TODAY!**

# WHY ADDITIVES?

## A STORY TOLD THROUGH DEFINITIONS

### FROM WEBSTER'S DICTIONARY

**Septic Tank:** "an underground tank in which waste matter is decomposed through bacterial action."

If there is too much solid material in your septic tank, the "bacterial action" is not taking place properly. Why? Not enough bacteria. Why? Let's look at the labels of some typical home-care products and see what Webster's says about them:

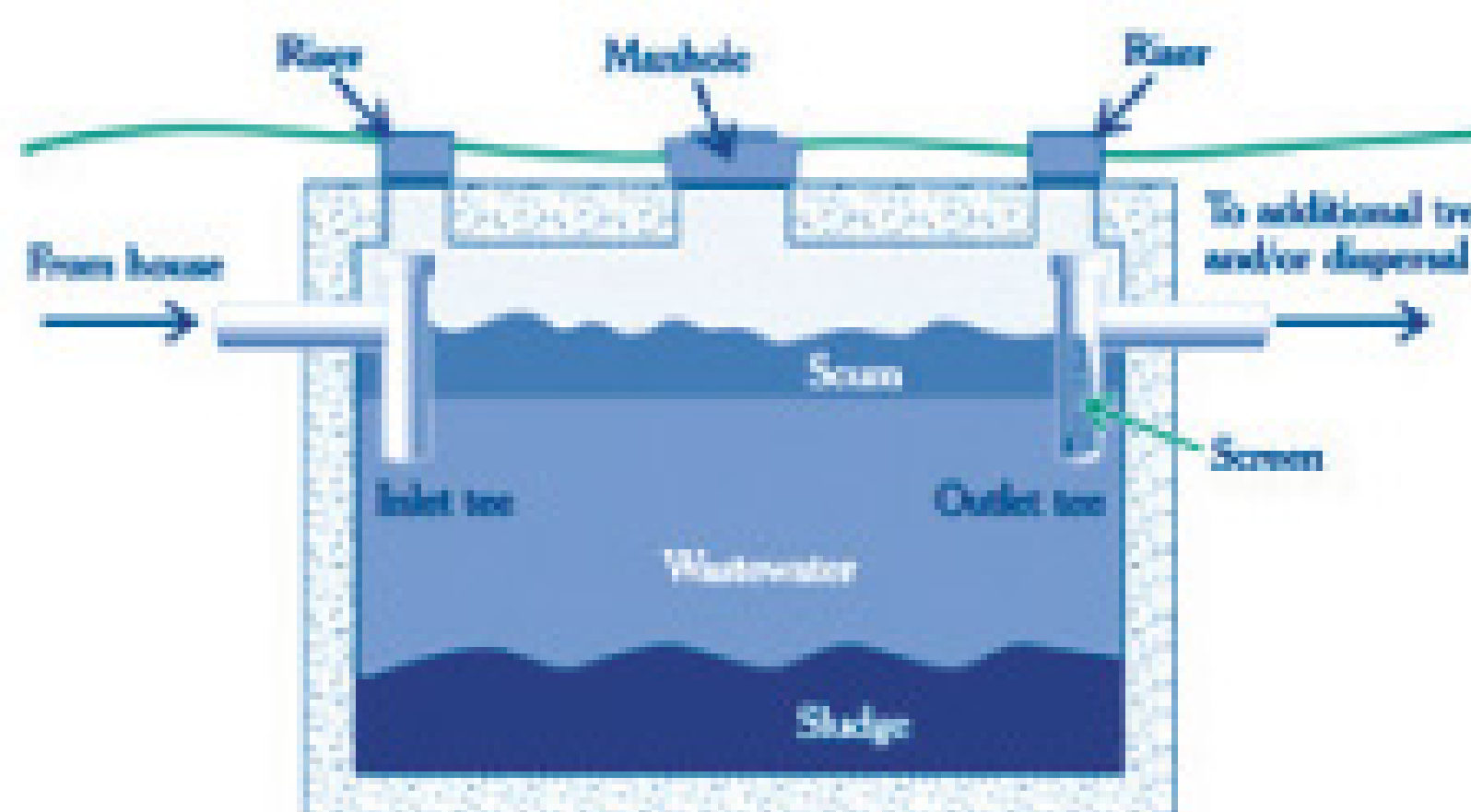

### WHAT'S UNDER YOUR SINK?

**Disinfectant:** "a means for destroying bacteria."

**Germicidal:** "an agent for killing bacteria."

**Antibiotic:** "having the capacity to inhibit the growth of or destroy bacteria."

**Sanitize:** "to free from germs by cleansing or sterilizing."

**Sterilize:** "to cleanse by destroying bacteria."

Have you noticed the recent rise in the use of anti-bacterial soaps?

**Anti-bacterial:** "destructive to or inhibiting the growth of bacteria."

Do you think of what anti-septic means as you flush mouthwash down the drain?

**Anti-septic:** "any substance that inhibits the action of bacteria."

These bacteria-killers are in products that we all use every day. Toilet disinfectants that get dispensed with every flush kill bacteria before they even get to the septic tank. Garbage disposals and water softeners also challenge the bacteria needed for proper septic tank operation. It's no wonder there are so many failing septic systems! Is there any word to look for that won't kill bacteria? Sure:

**Biodegradable:** "capable of being readily decomposed by bacterial action."

### THE CLEANER THE HOME, THE DEADER THE TANK

So are we saying to stop cleaning and disinfecting the house? Of course not. What we're saying is if you're going to regularly kill bacteria needed for proper septic tank operation, you need to regularly replace those bacteria with a monthly dosage of **CCLS**, "The Original" bacterial additive.

**CCLS** contains billions upon billions of the exact right, laboratory-enhanced bacteria to balance your septic tank and keep it running properly. **CCLS** is USDA-Approved, and has been used in households like yours since 1976.

For more information on the **CCLS** family of products for septic systems, grease waste systems, sewer and drain lines, for restoring drainage, and for portable restrooms, call us toll-free at 1-800-759-2257. We'll send you our product information packet, including prices and all our sales and customer education materials. Please call today. Thank you.

-Rick Howe, President



PARTNERS WITH  
SEPTIC PROFESSIONALS  
SINCE 1976

WWW.SEPTICONLINE.COM



Booth 149

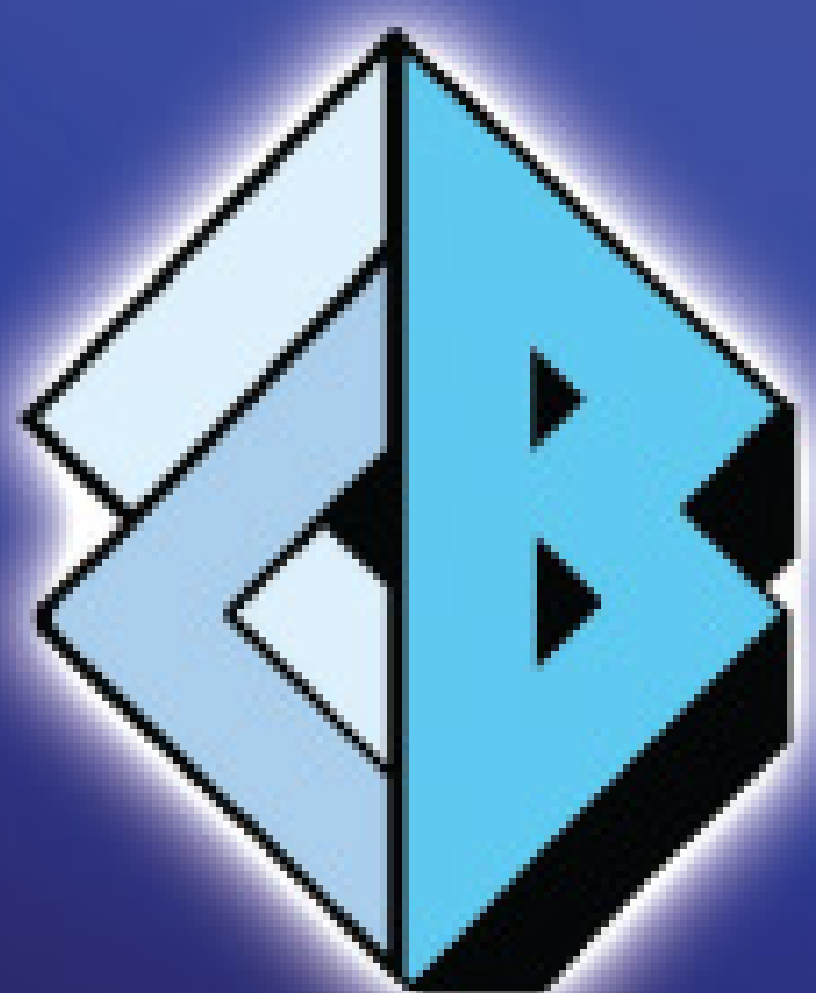
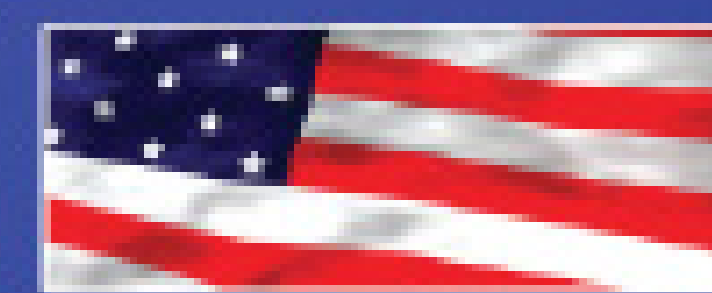

CAPE COD  
BIOCHEMICAL  
COMPANY

P.O. BOX 990 • POCASSET, MA 02559

1-800-759-CCLS

(1-800-759-2257)

FAX: 508-564-9974





**JAG Customers, Employees and Suppliers:**



**HAPPY NEW YEAR!**  
**Thank you for an outstanding 2007!**

**We look forward to being your partner  
throughout 2008!**

**JAG Mobile Solutions**  
**Restroom Trailers - Shower Trailers - Specialty Trailers**  
[www.jagmobilesolutions.com](http://www.jagmobilesolutions.com)



**DENVER**  
TRUCK SALES

**Nobody  
Beats Our  
Quality!**



**1996-2001 Western Stars**

435 Cats, Jake, 18 speeds 46,000 LB rears on Hendrickson air suspension. New 3360 gallon tank, HXL-400 Masport pump, serviced and checked.

**From \$64,950 plus F.E.T. on the tank**



**1997 KW T-800 Series**

60 Detroit, Jake, RTLO-16713 transmission, RT46160 46,000 LB 4.33 ratio, New 3360 gallon tank, Masport HXL-400 pump, New paint serviced and checked.

**\$66,950 plus F.E.T. on the tank**



**1996 IHC 9400**

14,000 LB f/a 3406 Cat, Jake, 15 speed transmission, 46,000 LB rears hendrickson air suspension. New 3360 gallon tank HXL-400 pump serviced and checked from

**\$62,950 plus F.E.T. On the tank**



**2001 Freightliners FL 120**

C15 475 Cat, Jake, RTLO-18918 trans, RT46160 on Hendrickson spring suspension, 4-way locks. New 3360 gallon tank HXL-400 pump

**\$79,950 plus F.E.T. on the tank**

**Easy Financing and Lease-To-Own WAC!**

**Denver Truck Sales • 5293 Vasquez Blvd. • Denver, CO 80216**  
Phone: 303-291-0960 • Fax: 303-291-0244 • [www.denvertruck.com](http://www.denvertruck.com)

**AMT**  
A Subsidiary of The Gorman-Rupp Company™

**12 VOLT DC HIGH HEAD WASHDOWN PUMP**

- 1 HP Washdown Duty Motor for Severe Operating Conditions
- Investment Cast 316 Stainless Steel, Cast Iron or Cast Bronze Construction
- All Models Equipped With High Efficiency Stainless Steel Impeller
- Discharge Port Rotates in 90° Increments
- Four Front Drain Plugs
- Maximum Flow 56 GPM
- Maximum Head 80 Ft. (35 PSI)
- Maximum Temperature 200° F



The AMT 12 Volt DC Washdown Pumps are designed for pumper, septic service, OEM, and marine applications requiring a DC motor. The motor has a one hour duty rating and is furnished with a grade 303 stainless steel shaft. Washdown Duty Pumps are available in a variety of construction and seal materials to meet your specifications. Pull-from-the-rear design for easy servicing without disturbing piping.

**Call us toll free at 888-268-7867 or visit our website  
[www.amtpump.com](http://www.amtpump.com) for more information.**

American Machine & Tool  
A Subsidiary of The Gorman-Rupp Company  
400 Spring Street  
Royersford, PA 19468

**ots**  
OFF THE SHELF™

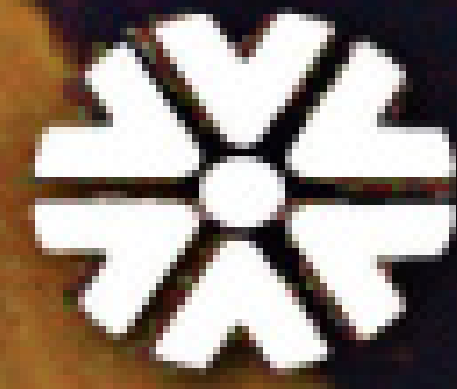

# CENTER CAPITAL CORPORATION®

A Webster Bank Company\*

# Financing geared toward your business success.

## THE INTELLIGENT CHOICE

### FOR INNOVATIVE FINANCING SOLUTIONS

## Environmental Equipment Financing Division

## Financing Geared To Your Business Success!

## The Intelligent Choice For Innovative Financing Solutions

Center Capital's Environmental Equipment Financing Division offers equipment leasing and financing services tailored to the unique requirements of the waste management and environmental industries. Unlike traditional lenders, our sales team has expertise in both financing and waste management. We understand the kind of payment plans that make sense for your industry. We understand the equipment. We understand the day-to-day business issues you face.

When you work with Center Capital, you're partnering with professionals who understand your business and what it takes to help it grow.

## ***We Cover 50 States!***

### PAYMENT PROGRAMS

STRUCTURED TO FIT YOUR NEEDS

### VENDOR VALUE-ADDED

PROGRAMS

### APPLICATION PROCESS

SIMPLIFIED

### MORE INFORMATION

### CONTACT

Robert A. Marino  
Sr. Vice President



Booth 185

Phone: 800-344-2224 • Fax: 215-542-1307  
Website: [www.centercapitalcorp.com](http://www.centercapitalcorp.com)

\*Center Capital Corporation is a Subsidiary of Webster Bank, N.A., Member FDIC



# The Solution For All Of Your Aluminum Vacuum Tank Needs



**5 YEAR WARRANTY ON NEW TANKS**

**IN STOCK**

7000 Gallon aluminum trailer, full length fender/hose trays, 60,000# Watson Chalin air ride suspension, polished aluminum wheels  
\$56,000 + FET



**IN STOCK**

3,800 Gallon aluminum tank on 2000 Freightliner chassis, with Jurop PNR 142 vacuum pump, \$64,900 tax included

## Longhorn Tank Co.

**P.O. Box 1147    Gravette, AR 72736    800-422-9840    479-787-7910**

***We Squeeze the Crap Out of Water™***

**Rotary Thickening and Dewatering**

Simple systems that are totally enclosed, compact and easy to operate.

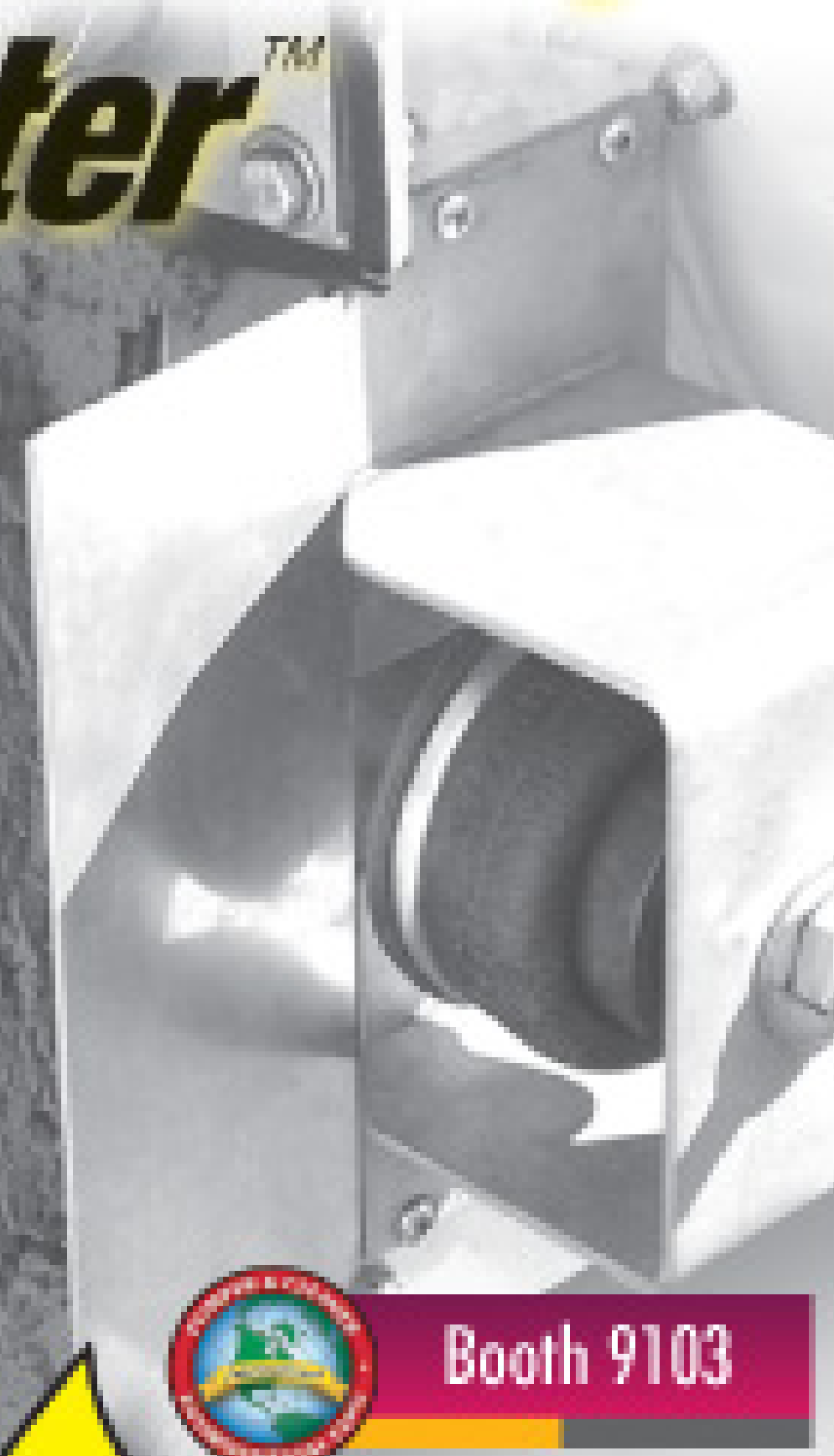

Booth 9103

**PRIME Solution inc.**



**PH: 269-673-9559**

**www.primesolution1st.com**

**Made In USA**

## CUSTOM SIGNS AND DECALS

 <b>United</b> SITE SERVICES 877-340-0004 800-638-1233	 (800) 446-4829 <b>A-Throne</b>	Another... <b>ANDY GUMP FENCE</b> 1-888-263-9486
 <b>Diamond</b> 1-888-744-7191	 <b>NATIONAL RENT-A-FENCE</b> 1-800-352-2675	 <b>HAULAWAY</b> 800-222-3337 haulaway.com

All Of Our Custom Manufactured Products Are Quality Engineered For Long Term Outdoor Durability.

- Very Competitive Pricing
- Knowledgeable, Helpful And Courteous Customer Service Staff.
- Dependable Delivery.
- Digital Print And Vinyl Cut Lettering
- Generic Signs And Decals
- And Much More!

Booth 20043

**DURABLE, AFFORDABLE AND BUILT TO LAST SINCE 1949**

**J.C. Gury Company Inc.**

530 East Jamie Ave, La Habra, CA 90631 Call (800) 903-3385 or (800) 556-5576  
www.jcgury.com

# PolyPortables' POWERTRIC

**NEW!**  
 TurboTabs now in water soluble packets  
 1st & 2nd Gears are ideal for Fall Events & Winter  
 Call for Introductory Price



## CHOOSE FROM THREE OF THE INDUSTRY'S MOST POWERFUL RESTROOM DEODORANTS

### TURBO TABS

- Self mixing tablet dissolves completely in seconds
- Ounce for ounce the strongest tablets you can buy
- Water soluble individually wrapped packets

### TURBO TUBES

- Portion-controlled liquid
- Pure concentrate, no water added
- Convenient tear-top packaging

### BLUE WORKS 150

- Ultra concentrated formula
- Highest level of fragrance and non-staining blue dye
- Superior odor-fighting technology

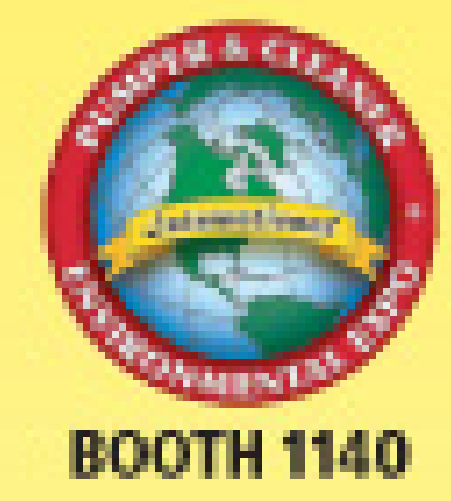

See for yourself. Try a FREE sample. Call Cindy or your PolyPortables regional manager at 800-241-7951

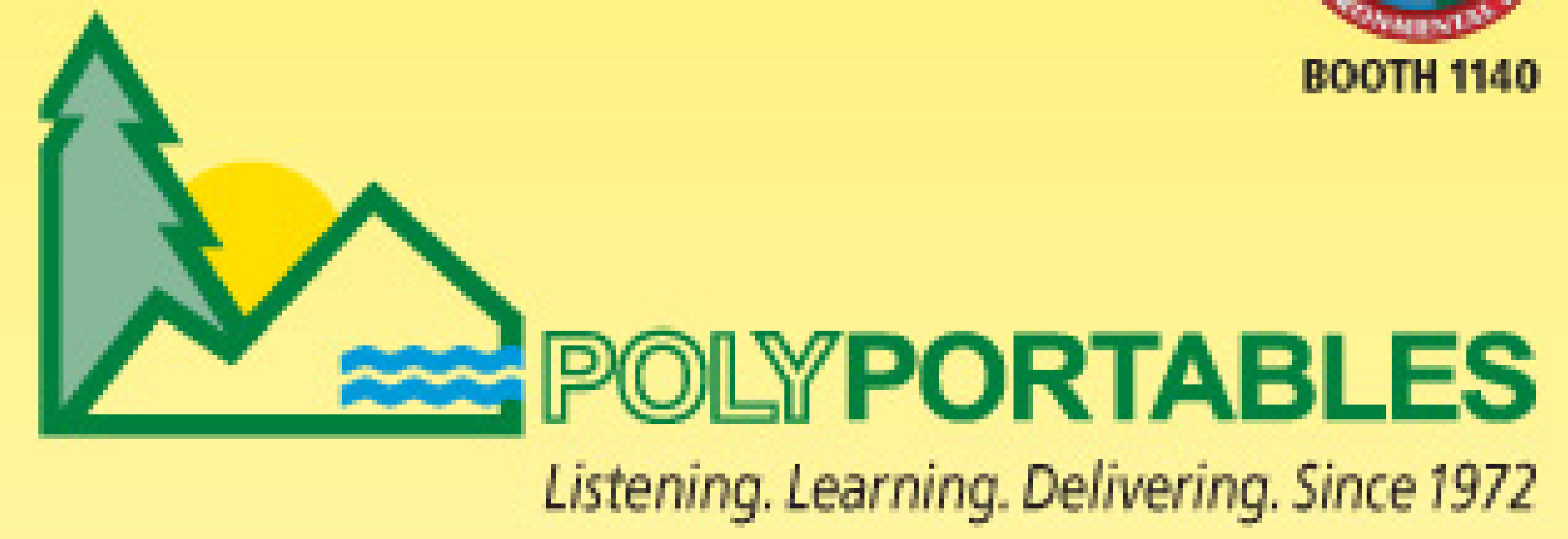

99 Crafton Drive, Dahlonega, GA 30533 USA • Phone (800)241-7951 or (706)864-3776 • Fax (706)864-8111 • www.polyportables.com

Only PolyPortables offers high-performance Green Way Products

RESTROOM DEODORIZERS • RESTROOM CLEANERS • AIR FRESHENERS • INSECT REPELLANT

All Green Way deodorizers, cleaners and air fresheners are earth-friendly, people-friendly products. They are developed and manufactured in our facilities in Dahlonega, Georgia by Green Way Products, a PolyPortables sister company.





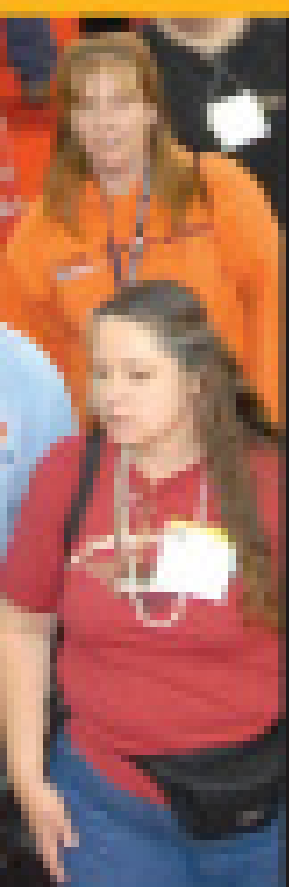

## It's all here

Exhibitors provide hands-on look at industry's latest technology.

By Ed Wodalski

A new year. A new location. New vendors and thousands of new products promise to make the 2008 Pumper & Cleaner Environmental Expo International in Louisville, Ky., the best ever. And seeing this is the Expo's 28th year – that's saying something. Although with three big days of educational seminars, nationally known entertainer Jeff Foxworthy, chart-topping Big & Rich, and nearly a million-square-feet of exhibition space you might not need much convincing. Still, we realize the one reason you come to the Expo is to get a hands-on look at the industry's latest technology. To help you plan your visit, here is a look at some of the many products you'll want to see.



## Safety Devices

### Ace Supply Co.

The Kwikk-Lokk Manway-SAFE-T vacuum interrupter provides vacuum truck operators with an extra margin of safety when



working with high-suction hoses. Designed to quickly break vacuum in case of an emergency, the device is available with optional Manhole Manager. [814/899-3644](tel:8148993644); [www.kwikk-lokk.com](http://www.kwikk-lokk.com); Expo booth 7146.

### T&T Tools Inc.

The insulated Mighty Probe provides protection against electrical shocks (up to 50,000 volts). The optional Slide Adapter enables the probe to be driven into hard ground. The probes feature a steel shaft with replaceable tip and are available in lengths from 3 to 6 feet in 6-inch increments. [800/521-6893](tel:8005216893), [www.tandttools.com](http://www.tandttools.com); Expo booth 3099.

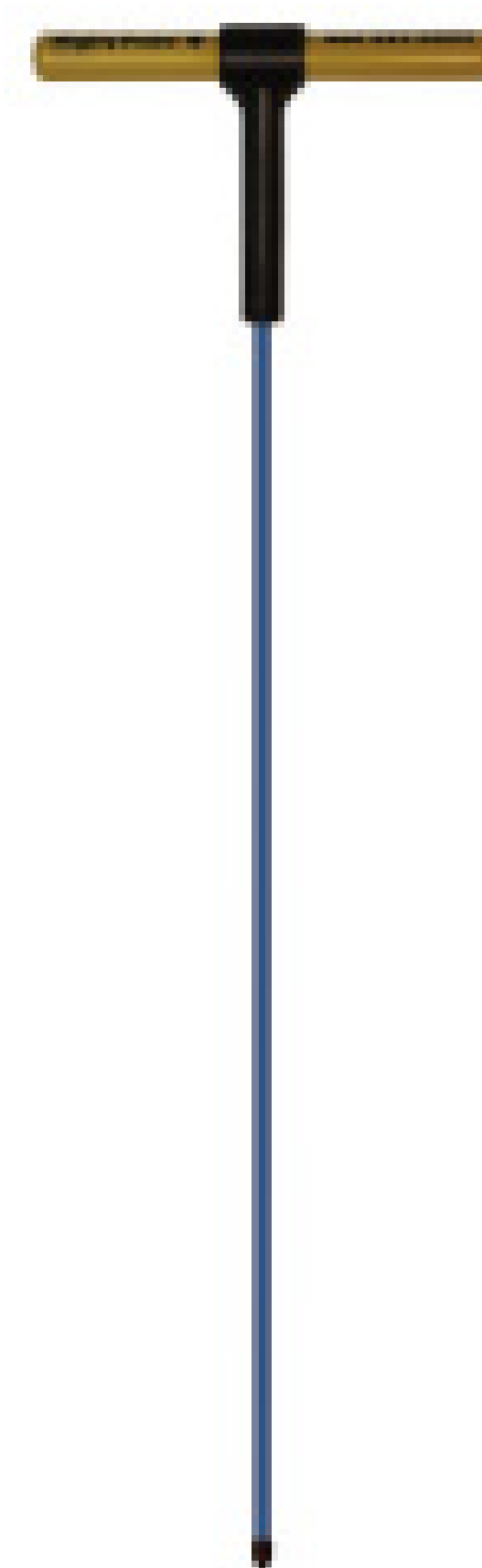

## Septic Treatment Systems, Accessories

### Advanced Wastewater Systems

Designed for homes and small systems, the two-compartment Super Septic Tank process uses straight flow through, and requires no electric power or moving parts. Waste enters the first compartment, settling the solids and floating the FOG. Wastewater flows through an effluent filter and into a

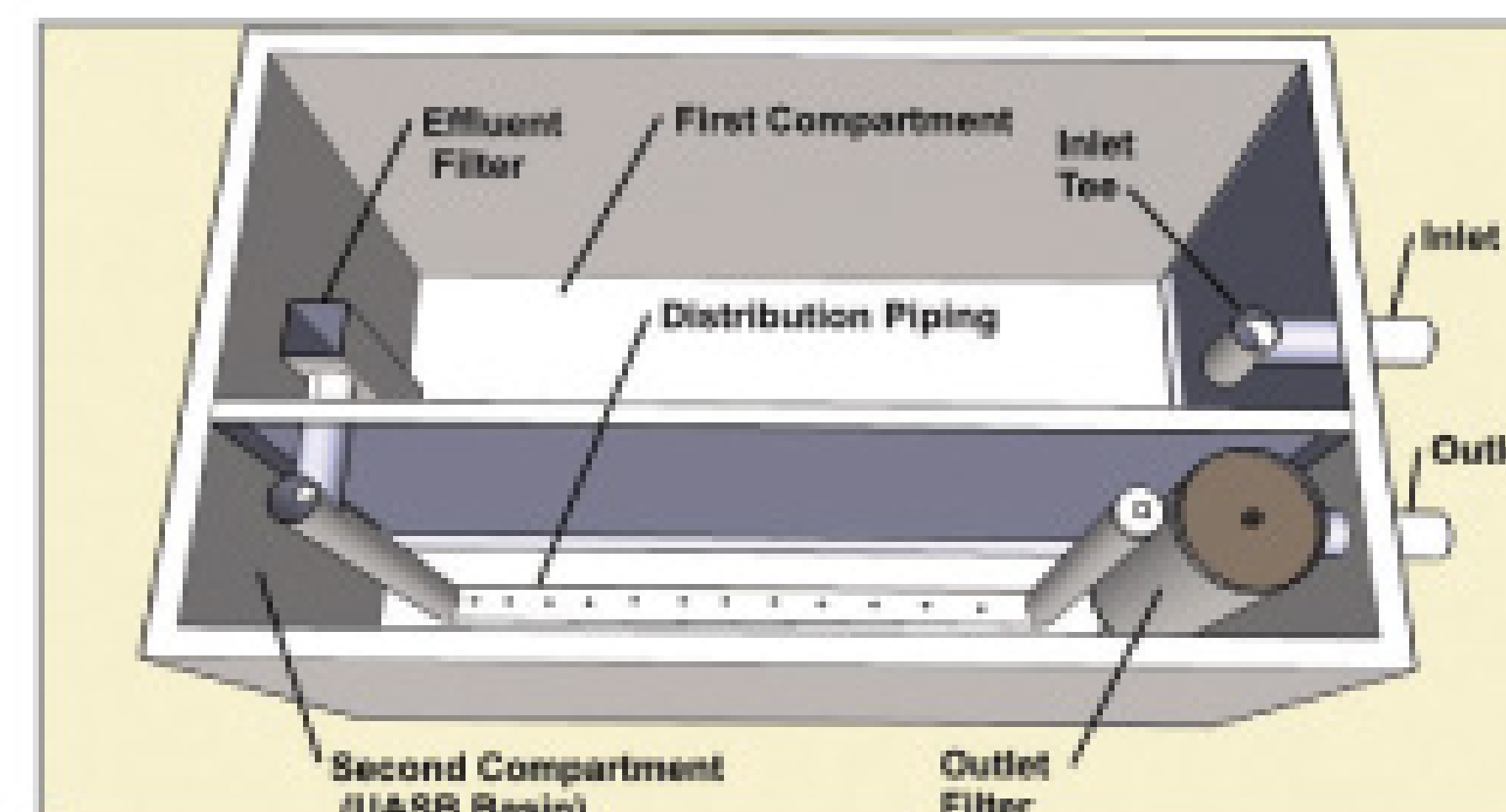

treatment basin in the second compartment, which acts as an upflow anaerobic sludge blanket. The treated water then passes through a proprietary foam filter, removing any remaining solids. [812/926-4282](tel:8129264282); [www.superseptic tanks.com](http://www.superseptic tanks.com); Expo booth 3009.

### Infiltrator Systems Inc.

The Aquaworx Remediator restoration system is designed to rejuvenate malfunctioning septic systems with minimal landscape disruption. Inserted into an existing tank, the device utilizes a permanent non-invasive process that promises to restore function in about two weeks. [800/718-2754](tel:8007182754), [www.infiltratorsystems.com](http://www.infiltratorsystems.com); Expo booth 4081.



## Consolidated Treatment Systems Inc.

Multi-Flo is a compact, environmentally friendly wastewater treatment system designed to provide the highest level of treatment and disposal through fixed film

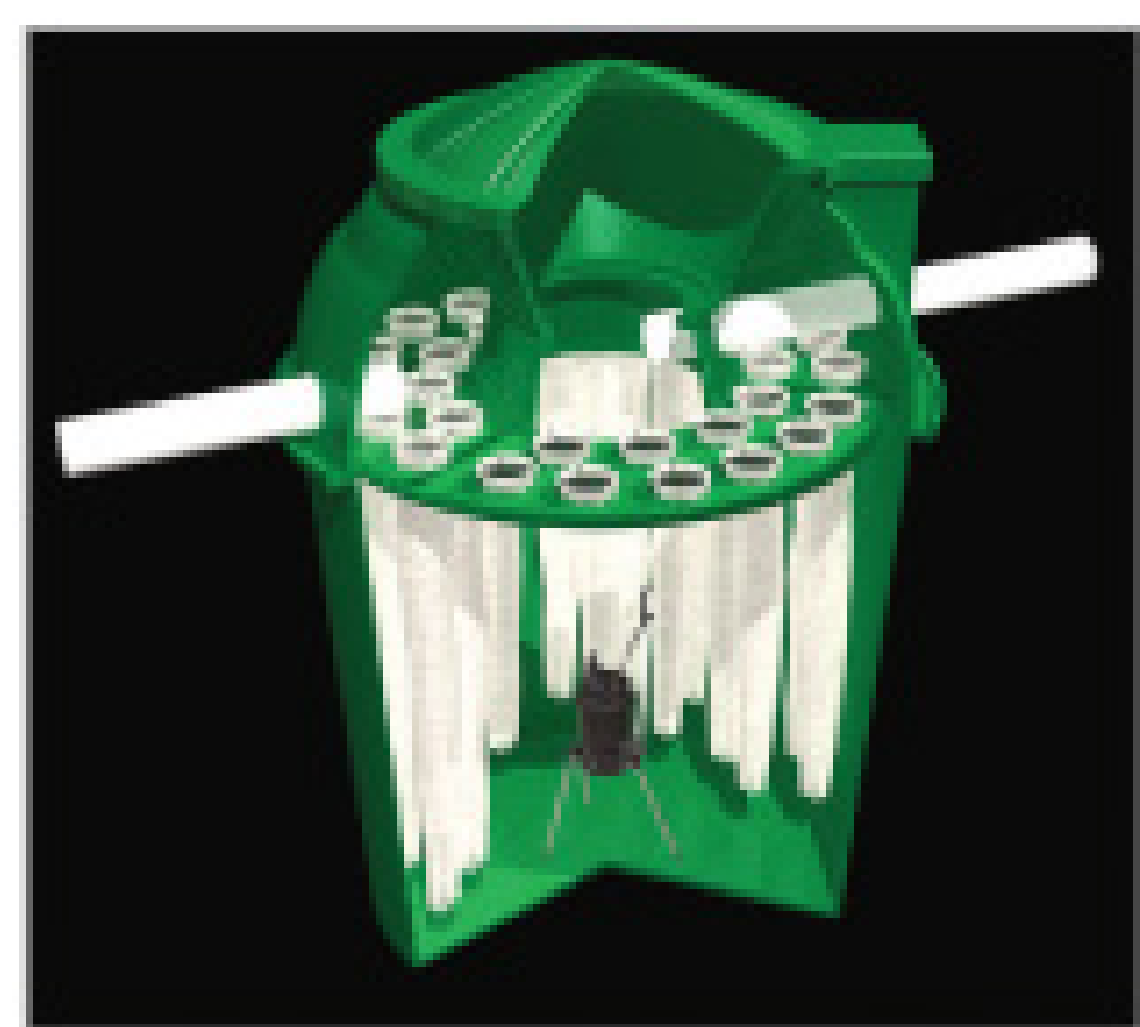

and growth digestion. Because of its no-bypass, positive-filtration design, the system promises clear, odorless effluent more than 95 percent

containment-free. It can be retrofitted to replace failing conventional systems and prevent drainfield damage and costly repairs. The unit features 132-square-feet of fixed-film internal media and an effluent submersible aerator. 937/746-2727, [www.consolidatedtreatment.com](http://www.consolidatedtreatment.com); Expo booth 9306.

## Premier Tech Environment

The Ecoflo biofilter treatment system is designed for the sanitary drainage of decentralized dwellings. Preceded by a septic tank, the chain of treatment includes a biofiltration unit and polishing field. The system promises to produce effluent with concentrations

lower than 15 mg/L in TSS and BODs, and 50,000 FCU/100 mL in fecal coliforms.



Combined with a 12-inch layer of native soil, the system ensures a reduction of nutrients and pathogens to groundwater and surface water. The organic filter is engineered to capture the majority of suspended solids and other pollutants, helping to avoid clogging of soil. 800/632-6356, [www.premiertechenv.com](http://www.premiertechenv.com); Expo booth 4164.

## Salcor Inc.

The Model 3G ultraviolet disinfection unit is designed to reduce fecal coliform bacteria levels by 99.9 percent, according to third-party NSF testing. It is rated for 4,320 gpd with TSS less than 30 mg/L, or up to 8,640 gpd if TSS and BOD are less than 10 mg/L. The unit operates on 120-volt, AC power and can be installed in less than 30 minutes. The disinfection chamber is made of UV-resistant plastic and is permanently installed below grade. When the chamber is full, the UV light operates continuously at a temperature range of 105 to 120 degrees F for optimal disinfection. 760/731-0745; Expo booth 13063.

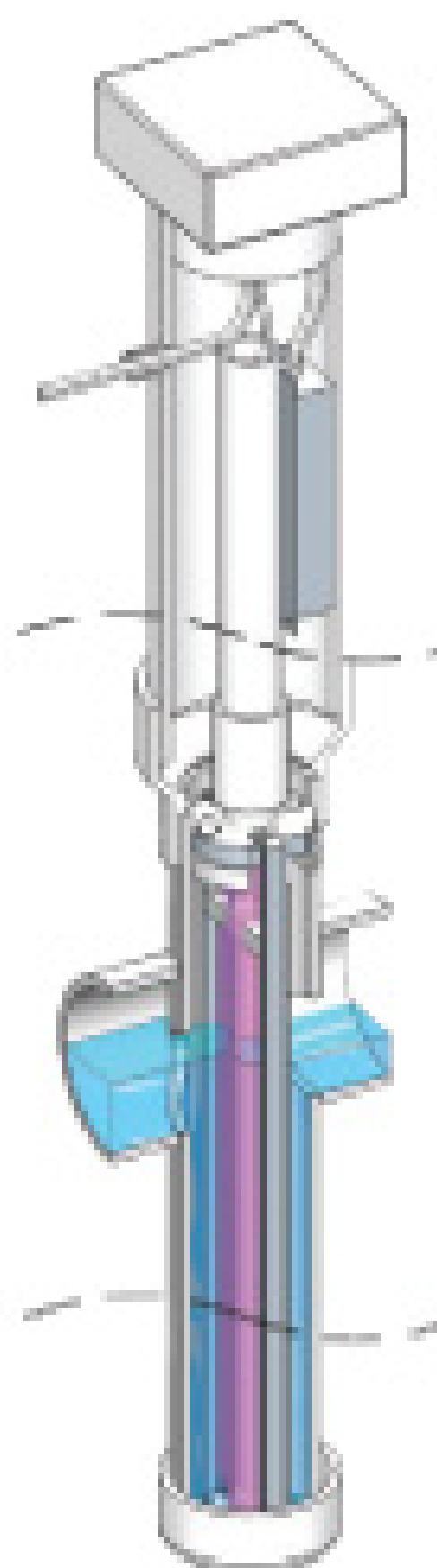

## Sim/Tech Filter Inc.

The STF-100A2 pressure filter is designed to keep mounds, sand filters and other pressurized distribution systems operating efficiently, and can also be used as pre-filtration for drip irrigation and bio-diesel production. This low-head loss (0.21 psi) filter mounts on the discharge side of the effluent pump, acting as a last line of defense. A single 2-inch filter can handle flow rates up to 83.8 gpm. Larger 3- and 4-inch filters are available. The standard screen filters to 1/16 inch, while optional socks allow for filtration as fine as 100 microns (0.004 inch). 888/999-3290; [www.gag-simtech.com](http://www.gag-simtech.com); Expo booth 4176.

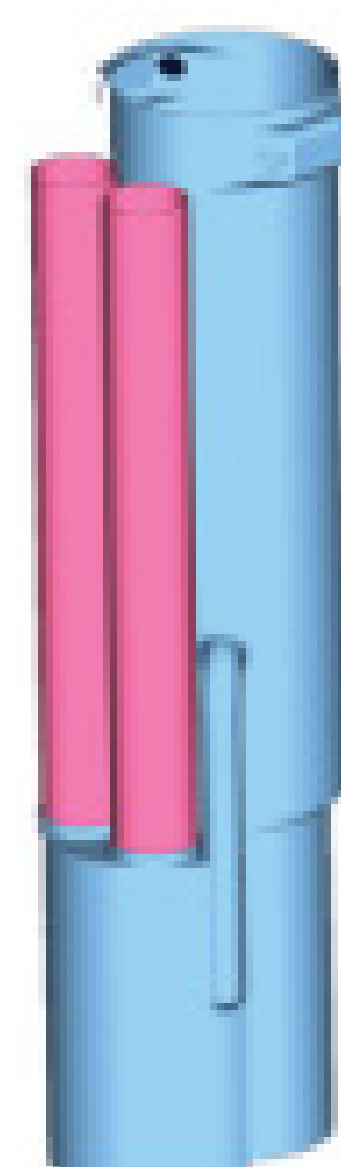

## Concentric Enviro Inc.

The 12-inch diameter BioPlex pump filter is available in lengths of 48, 57 and 68 inches; other sizes are optional. Filtration is available in either 1/16 or 1/8 of an inch. The filter cartridge features a large surface area for extended service. Hanging bar handles and float trees with mount are

included. Full STEP systems with risers, lids, splice boxes, float assemblies, control and alarm panels, pumps, grommets and discharge assemblies are available.

406/227-6792; Expo booth 18030.

## Polylok Inc.

The Flow Controller is a combination flow divider and director that attaches directly to Schedule 40 or Schedule 35 pipe. Engineered for alternating or dividing flows between two separate fields, it can equally split the waste stream or direct all flow to the right or left. 888/765-9565, [www.polylok.com](http://www.polylok.com); Expo booth 3115.

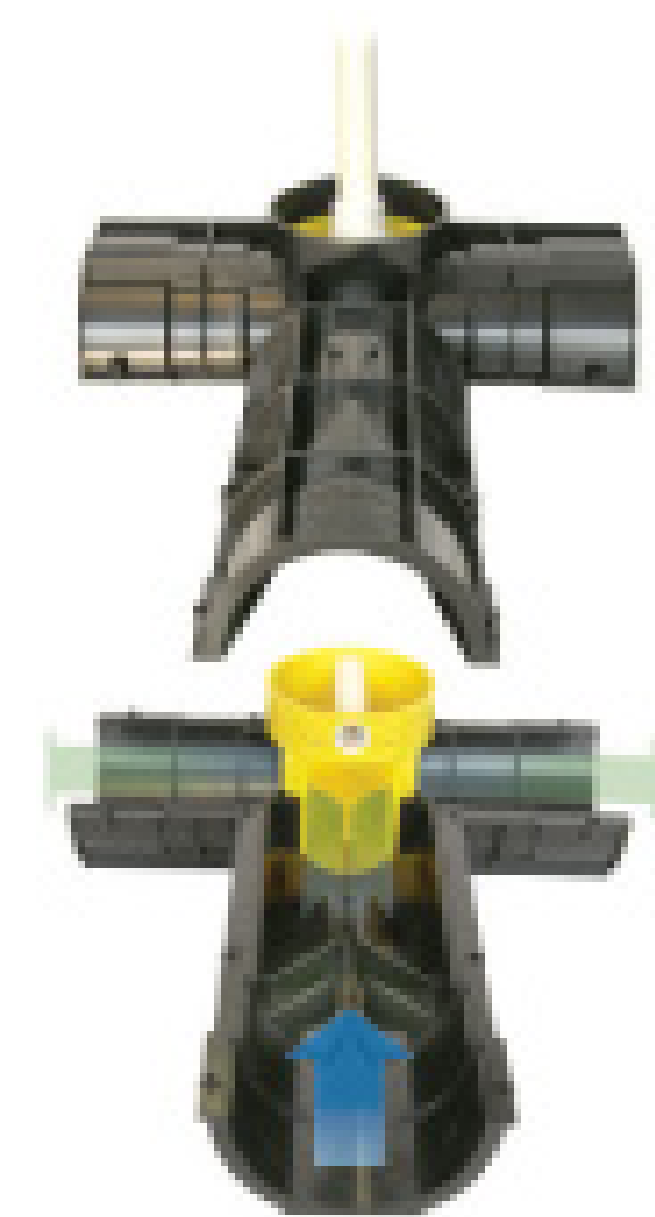

## RotoSolutions

Roto-molded septic tank and grease interceptor lids are made of durable, lightweight polymers for easy handling and transportation.

Sold as complete kits, including stainless-steel hardware components, the lids are designed to fit 18-inch or 24-inch I.D. corrugated pipe and can be used with or without the sand-filled option. 800/868-0973, [www.rotosolutions.com](http://www.rotosolutions.com); Expo booth 63.



## Septic Services Inc.

The Flagg-Air 340 aeration unit features a fully enclosed, continuous duty, double-insulated motor with protective cap. The 1/4-hp motor runs at 3,450 rpm. The high-impact, tapered aspirator and suds restrictor are mounted on a 5/8-inch, stainless-steel shaft with corrosion-resistant counter shaft. Galvanized steel brackets with rubber vibration restrictors are designed to reduce noise. The unit has oversized and pre-lubricated bearings. It can replace most other aerators, has a 2-year limited warranty, but does not carry the NSF seal. 800/536-5564, [www.septicserv.com](http://www.septicserv.com); Expo booth 6097.







### Pro-Sept

The septic system warranty program is designed for both new and existing septic systems, and promises up to \$25,000 toward repair or replacement costs resulting from system malfunction. The initial 3-year plan can be renewed following a tank pump-out, visual inspection and preventive maintenance, if required. [888/354-0677](tel:8883540677), [www.powderhornagency.com](http://www.powderhornagency.com); Expo booth 10053.

## Restrooms and Accessories

### Armal Inc.

The Scent Box portable restroom features an integrated scent for a pleasant, lasting fragrance. Available in Apple Blossom, Pinewood Trail, Rose Sensation, Strawberry Field, and Vanilla Balm, each unit also has a decorative permanent design on the walls, corresponding to the scent of the unit. [866/873-7796](tel:8668737796), [www.armal.biz](http://www.armal.biz); Expo booth 7069.



**PolyPortables Inc.** The Family Room portable restroom features a Koala baby-changing station, as well as a choice of a 40- or 60-gallon corner tank, Bactisan hand-sanitizer, motion-activated lighting, shelves, coat hooks and trash can. [800/241-7951](tel:8002417951), [www.polyportables.com](http://www.polyportables.com); Expo booth 1140.

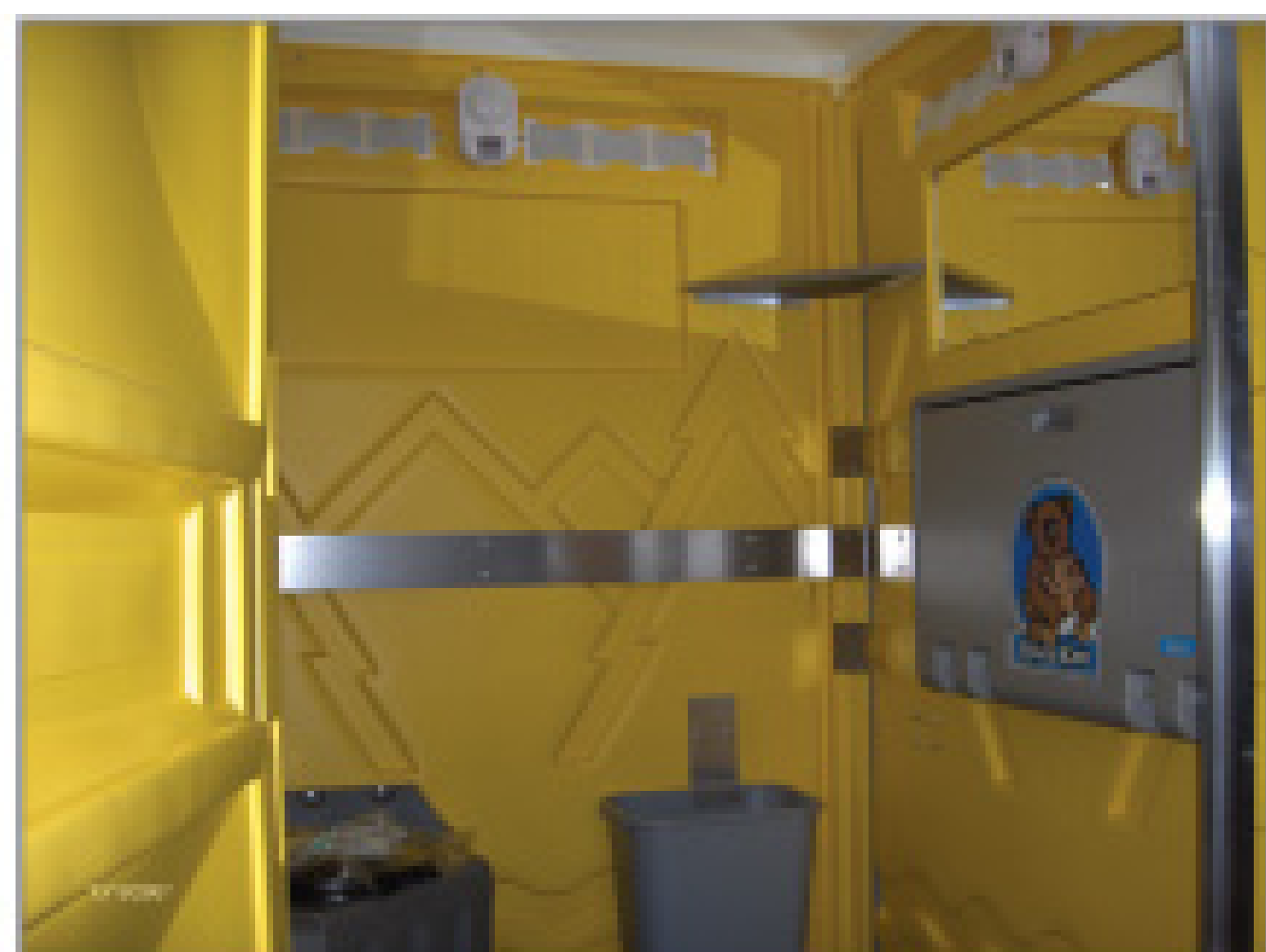

### Ameri-Can Engineering

The 828 Oasis ADA events-quality restroom trailer is designed for large groups, while providing easy handicapped access. Featuring an 8-foot by 28-foot steel unibody frame, the unit has 6,900-pound Dexter TorFlex axles, 800-gallon waste holding tank and 30,000 Btu air conditioner. Standard equipment includes electric brakes on each wheel, 2 5/16-inch adjustable hitch, 16-inch on center steel floor joists, and city sewer and water hookups. Both the women's and men's units feature flushing, water-saving stools and stainless steel sinks. The Oasis interior features marble countertops, Formica cabinets, wider partitions and oak trim. [574/892-5151](tel:5748925151), [www.ameri-can.com](http://www.ameri-can.com); Expo booth 5053.

### JAG Mobile Solutions

Porta-Lisa Plus is a compact 12-foot by 7-foot restroom trailer, featuring three private rooms, air conditioning, flushing toilets, 156 gallons of onboard running water and a 470-gallon capacity waste tank. The "Super Chute" function allows trash to accumulate in the service area containers rather than collecting inside the trailer. A solar panel option enables the trailer to be powered all day without recharge. The trailer is available as an economical or durable Industrial unit, streamlined simplicity as a Functional unit or stylish elegance as a Fantastic unit. [800/815-2557](tel:8008152557), [www.jagmobilesolutions.com](http://www.jagmobilesolutions.com); Expo booth 7131.



### Alpha Mobile Solutions

The Century X public restroom trailer features windows in entry and exit doors, LED entry and exit lights, upgraded wheel package, key-lock door knobs, scissor-jack levelers and roof-mount air conditioning with heat strip. Other standard features include connections for 100-volt electricity, water hose, 740-gallon waste and 200-gallon freshwater tank, self-flushing porcelain urinals and porcelain toilets. The unit also has vanity cabinets for storage with locking doors, stainless steel sinks with auto shutoff faucets, fluorescent lighting, shatterproof mirrors, button-grip rubberized one-piece floor, LED waste tank monitor and LED freshwater tank monitor. [877/789-1213](tel:8777891213), [www.alphamobilesolutions.com](http://www.alphamobilesolutions.com); Expo booths 11060-61, 11063.



### PolyJohn Enterprises Corp.

The SaniStand towelette and foam dispenser kills 99 percent of germs on hands, including E. coli and salmonella. The dispenser holds 1,320 moist, sanitary, antiseptic wipes that clean hands with moisturizing aloe vera formula. Designed to be used with Sani-Hands II wipes from Rid It, the four-unit foam dispenser holds enough cleaner to sanitize the hands of over 5,300 individuals. [800/292-1305](tel:8002921305), [www.polyjohn.com](http://www.polyjohn.com); Expo booth 4031.



### Poly-Klyn

The portable and multiple Inox sink folds or unfolds at the press of a button in approximately 10 seconds. Made from stainless steel 304, it measures 89.4 by 37 by 7.7 inches (folded) and 43 inches (unfolded).





Weighing 154 pounds, the sink has two water drains and eight taps with press-timing device. [902/107-307](tel:902107307), [www.poly-klyn.com](http://www.poly-klyn.com); Expo booth 18015.

### AllGreen Manufacturing LLC

The portable Indoor/Outdoor sink with hot water is fully self-contained and designed to run on bottled water. It features a 2 1/2-



gallon water heater, water pump to fit any 5-gallon water bottle, trapped drain connected to a 6-gallon waste tank, 15-by-15 stain-

less-steel sink, GFI cord, and soap dispenser. A 12-volt system with propane water heater is available. [401/434-1468](tel:4014341468), [www.allgreenmanufacturing.com](http://www.allgreenmanufacturing.com); Expo booth 20037.

### Satellite Industries Inc.

The High Tech II Deluxe Flush transport features a heavy-duty drop-axel trailer fitted with two High Tech II portable restrooms. Onsite, the restrooms sit 2 inches off the ground for easy access. Inside amenities include an industrial grade flushing system and clean-water hand-wash. [800/883-1123](tel:8008831123), [www.portabletoilet.net](http://www.portabletoilet.net); Expo booth 1122.



### Deal Associates

The Super Mongo Mover takes the strain out of portable restrooms setups, including ADA handicap models. Its lightweight aluminum frame and multiple wheels enable it to cross the softest ground, including beach sand and muddy construction sites. The mover also has no folding joints that can become clogged with dirt and rocks. [866/599-3325](tel:8665993325), [www.dealassoc.com](http://www.dealassoc.com); Expo booth 6059.



### McKee Technologies

The lightweight Explorer restroom trailer is available in a wide range of sizes. Its low-profile deck enables one person to load and unload units, while the strap-and-winch



system quickly secures them to the trailer. Galvanized carrier rails help eliminate maintenance costs. [866/457-5425](tel:8664575425), [www.mckeetechnologies.com](http://www.mckeetechnologies.com); Expo booth 7046.

### Monarch Coin & Security Inc.

The token/coin operated restroom lock is a simple mechanical device that has been around for many years, but has seen a renewed interest with the demand for access control. Specific uses include jobsites where it can allow workers in but keep transients out. [800/462-9460](tel:8004629460), [www.monarchcoin.com](http://www.monarchcoin.com); Expo booth 9207.

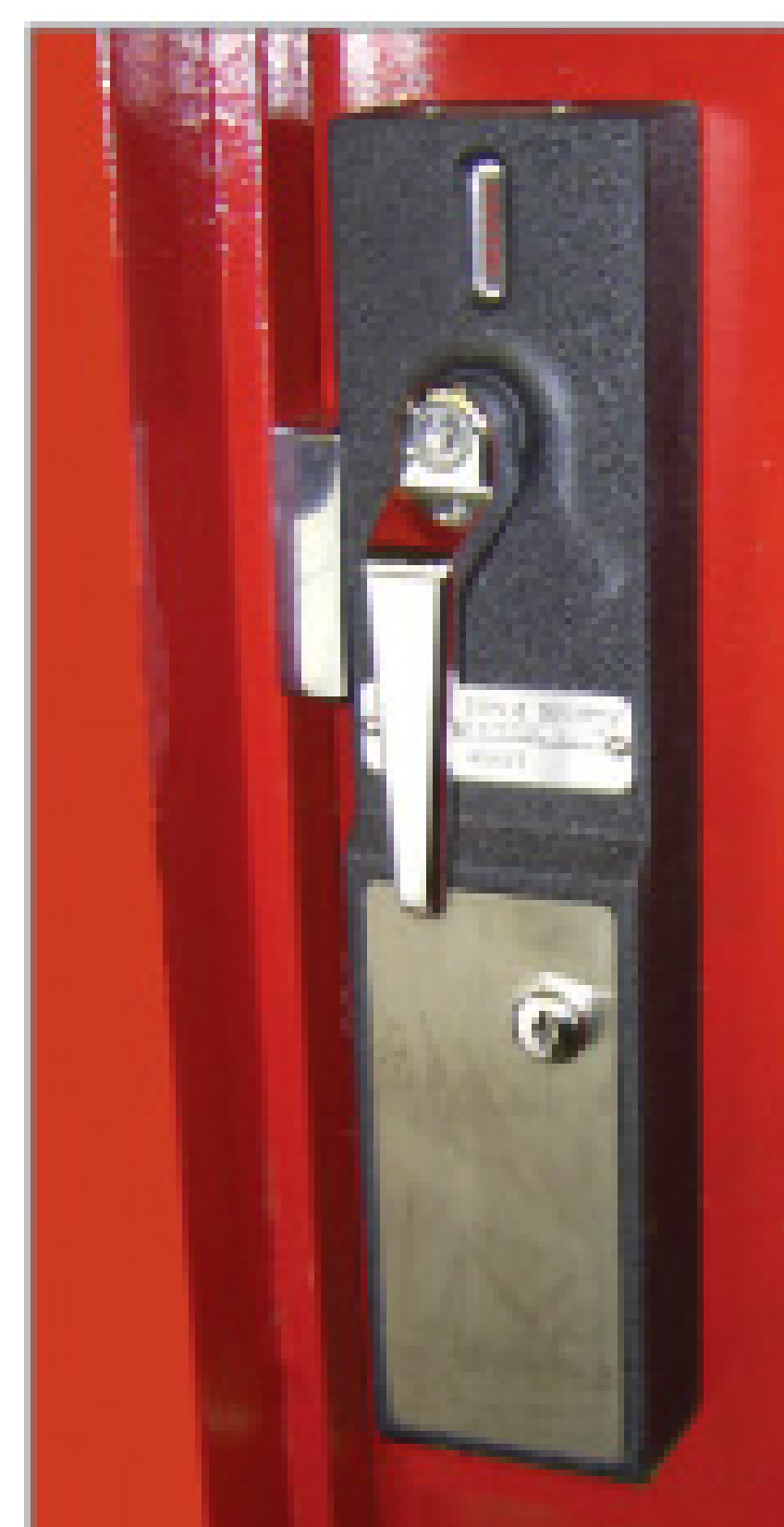

## Data Systems

### Clear Computing and Insight USA

The TACTrackerPRO wireless, lightweight scanner provides real-time restroom inventory tracking and reporting. The device enables the route driver to scan a bar code or RFID chip, sending the exact location, date and time of service back to the office, where it can be displayed and tracked on a



color-coded service map. Scanned data is automatically updated. Where bar codes are missing, the driver can scan the coded route sheet. [888/332-5327](tel:8883325327); [www.clearcomputing.com](http://www.clearcomputing.com); Expo booth 3173.

### Ritam Technologies

The ERIT electronic routing and inventory tracking subsystem is designed to track field servicing of portable restrooms and other repetitive services, such as grease traps. For proof of service, simply touch the reader to the button. Reporting functions alert management to areas that require attention: excessive driving time or stops between services, lengthy service times, or missed services. [800/662-8471](tel:8006628471), [www.ritam.com](http://www.ritam.com); Expo booth 118.







### Tracker Solutions

The menu-driven Septic Tracker is designed to track septic pumping services, including customer transactions, payment history, disposal site usage and holding tanks. The software also can be used to schedule work orders, set up reminders for future service, create vehicle service reports, and other functions. [888/308-0651](http://888/308-0651), [www.septictracker.com](http://www.septictracker.com); Expo booth 66.

### Wells Cargo C.O.G.

The GPS monitoring system utilizes wireless Web technology to track restroom trailers, and monitor freshwater and wastewater tank levels, interior temperatures and electrical flow from a laptop or cell phone. Alarms can be set to activate cell phones, warning of potential problems. [888/574-4222](http://888/574-4222), [www.wellscargocog.com](http://www.wellscargocog.com); Expo booths 4211-13; 4217, 4219.

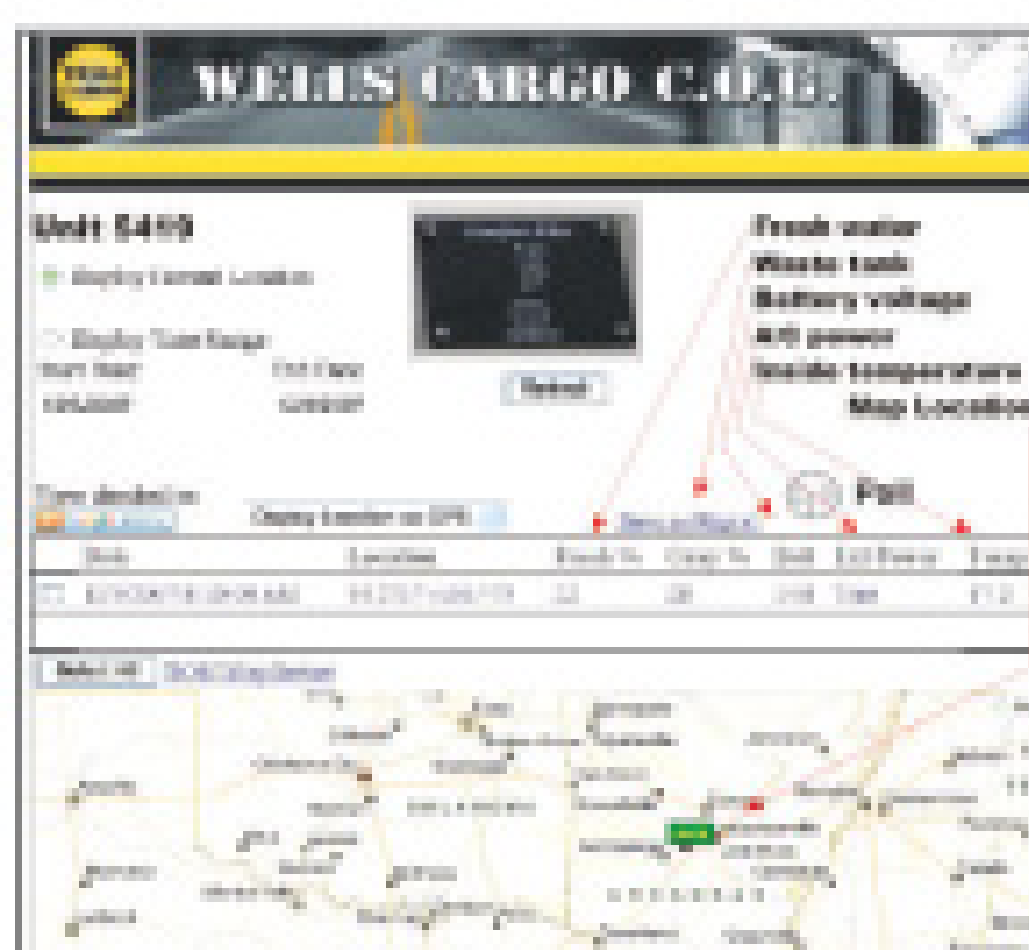

### Famhost

The Linkwriter wireless pen enables drivers to transmit paperwork from the jobsite to the office in seconds. Using a digital pen and regular paper printed with a special background, a tiny camera registers the pen's movement. When the user checks "send," data is transmitted through a Bluetooth-enabled phone, wireless laptop, tablet PC or desktop for viewing. Data is



stored as both an image and text, enabling inventory to be updated in real-time. [800/658-1676](http://800/658-1676), [www.linkwriter.com](http://www.linkwriter.com); Expo booth 4140.

## Pumps

### Liberty Pumps

The Omnivore 2-hp grinder pump with V-Slice Cutter Technology provides 367,000 cuts per minute for superior shredding performance in demanding sewage applications. An open volute design eliminates the cutwater - improving solids flow and reducing potential jamming. Other features include a one-piece cast iron body, quick-disconnect power cord, stainless steel impeller and dual shaft seals. Complete pre-assembled systems are available. [800/543-2550](http://800/543-2550), [www.libertypumps.com](http://www.libertypumps.com); Expo booth 9215.



### Thompson Pump & Manufacturing Inc.

The compressor-assisted, dry-prime TSC series trash pumps are designed for flows to 1,750 gpm, heads to 172 feet and spherical solids to 3 inches. Ranging from 4 to 6 inches in size, the pumps are made for



sewage bypass or general dewatering and feature the environmentally friendly ENVIROPRIME system, designed to prevent fluids, such as sewage and containments, from entering the venturi and spilling on the ground. The weather-resistant, sound-attenuated Silent Knight canopy enables the

pumps to operate at 70 dBA or lower for use in residential areas or near schools or hospitals. [800/767-7310](http://800/767-7310), [www.thompsonpump.com](http://www.thompsonpump.com); Expo booth 8025.

### Orenco Systems Inc.

The ProSTEP pumping package is designed to pump effluent from a septic tank, to a drainfield, secondary treatment or effluent sewer. The package includes the PVU Pump Vault, a PF high-head effluent pump, Biotube effluent filter, float switches, control panel and discharge assembly. The vault can accommodate one or two pumps. Options include electro-mechanical or programmable logic control panels, telemetry, 50-gpm pumps, simplex or duplex pumping systems and various float arrangements and discharge components. [800/343-9843](http://800/343-9843), [www.orencosystems.com](http://www.orencosystems.com); Expo booth 6115.



## Pressure Washers

### Durand-Wayland Inc.

The John Bean SewerJet 700 pressure washer is designed to handle serious emergencies as well as routine, preventive maintenance, such as cleaning grease from the sides of manholes. The unit can be operated by one person, tows easily and doubles as a cleaner of power equipment, including dozers, graders, mowers and trucks.



[800/241-2308](http://800/241-2308), [www.johnbeansprayers.com](http://www.johnbeansprayers.com); Expo booth 2017.

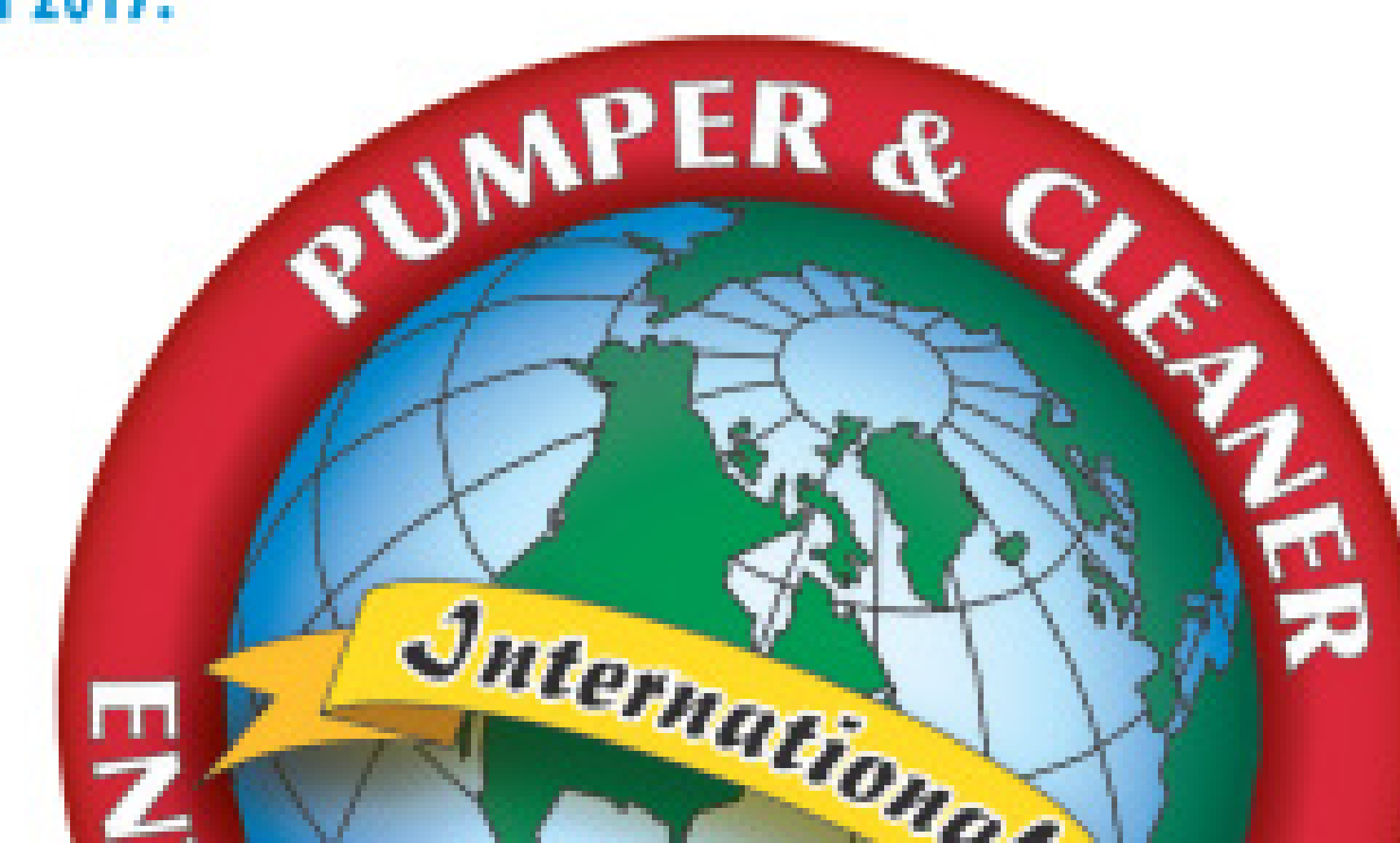

## Monitoring Systems

### Moro USA East

The Accu-Level liquid waste indicator has no internal tank components, so there's nothing to clog. Factor calibrated, the indicator measures from 0-100 percent of tank volume in gallons, and features an additional channel for measuring two-compartment tanks, when used with the complementary pickup unit. [800/383-6304](http://800/383-6304), [www.morousaeast.com](http://www.morousaeast.com); Expo booth 6101.



### Septronics

The TS150 and TM2 liquid level alarms are designed for applications that require two inputs for dual monitoring. Alarm applications include sump and sewage, filter and pump, high level and low level, or one



alarm for two units, as in duplex housing. Standard features include automatic alarm reset, green power-on LED, red LED and yellow LED alarms, horn silence, test alarm, and touch-pad operation. [888/565-8908](http://888/565-8908), [www.septronicsinc.com](http://www.septronicsinc.com); Expo booth 59.

## Educational, Marketing, Financing

### Leaders Resource Network

Services include training and educational workshops, business planning, new business development, customer retention, research survey and collections services, consulting, coaching and peer-to-peer advising along

with product and services marketing, strategic plans, brand identity, Web site development, brochures, direct mail, newsletters and more. [574/276-0217](http://574/276-0217), [www.leadersresourcenetwork.com](http://www.leadersresourcenetwork.com); Expo booth 20009.

### Cape Cod Biochemical Co.

What Everyone Should Know About Septic Tank Systems is a condensed version of the Cape Cod Biochemical Co.'s industry-standard brochure that explains - in easily understood terms - how proper septic tank operation is upset by many of the home-care products used every day. [800/343-8007](http://800/343-8007), [www.septiconline.com](http://www.septiconline.com); Expo booth 149.



### Stamp Works

Magnets of various sizes and thickness can be made in the shape of pump trucks, vans, roll-off trucks, portable rest-rooms and more - each featuring company name, phone number a brief description of services offered. [800/758-2743](http://800/758-2743); Expo booth 51.



### Capital Partners LLC

The New Business Advantage can assist liquid waste haulers with up to \$50,000 in financing as part of its \$2 million line of credit, reserved exclusively for liquid waste startup companies. [866/769-2345](http://866/769-2345), [www.yourcapitalpartnec.com](http://www.yourcapitalpartnec.com); Expo booth 7070.

## Hydro-Excavators, Trucks, Accessories

### Ring-O-Matic Mfg.

The 550 hydro-excavator features a 50-hp Cat diesel engine, 850-cfm lobe-type blower and high-pressure Cat water pump, producing 5.5 gpm at 3,500 psi. The unit also has a 200-gallon water and 550-gallon spoils



tank, hydraulic remote-control boom, pressurized offload, full-opening hydraulic door and low tongue weight for towing safety. [641/780-4099](http://641/780-4099), [www.ring-o-matic.com](http://www.ring-o-matic.com); Expo booths 7042-43.

### SuperVac 2000

The Hydro-Excavator SVHT-6400 features an 840,000 Btu, 6,000-psi boiler and 6,000-psi, 10-gpm water pump with 3,000-gallon debris tank, double-wall insulated



1,200-gallon co-polymer/polypropylene water tank, 6,400-cfm, 27 Hg vacuum pump, two cyclones and cartridge filter. Other features include hydraulic door locks, insulated enclosure (less than 83 dBA) and a 100-foot hose reel. [866/839-5702](http://866/839-5702), [www.supervac2000.com](http://www.supervac2000.com); Expo booth 7031.

### GapVax Inc.

The HV Series of vacuum trucks feature a highly efficient filtration system, low filter baghouse maintenance and long filter bag service. The long tank measures 11 feet, 6 inches from inlet to outlet for more drop out before filtration. Seven cyclone separators are designed to remove 75 to 85 percent of dry carryover and 100 percent wet carryover, while the baghouse features 46 standard polyester filter bags. The microscreen filter is engineered to provide final fail-safe protection for the blower and filters to 600 microns. More efficient loading can also reduce fuel consumption. [814/575-6766](http://814/575-6766), [www.gapvax.com](http://www.gapvax.com); Expo booth 1022.







### Capital Rubber Corp.

The Power Booster by Pressure Lift attaches to a WeatherFlex or other vacuum hose line, providing greater vertical lift and distance. Powered by compressed air



or water, the unit also breaks up solids, reducing stress on the vacuum pump and decreasing pump times. 800/258-3000, [www.capitalrubbercorp.com](http://www.capitalrubbercorp.com); Expo booth 3093.

### Cougar Industries Inc.

Completely sealed against dust and water, the Model NHD-110 hydraulic vibrator promotes the flow of material out of the pump truck, ensuring that material is not hauled back to the job-site. The unit also helps eliminate premature wear and tear on equipment, specifically hydraulic cylinders, brakes, clutch and transmission. Operated from inside the cab, it also reduces the risk of lost time and a potential workman's compensation claim. 800/262-2106, [www.cougarindustries.com](http://www.cougarindustries.com); Expo booth 3051.



### Kroy Industries

The 6-inch and 8-inch Kroy Vac couplers offer an O-ring seal for vacuum or pressure usage. Designed for the vacuum industry, the inside bore of the coupler is smooth to prevent against wear from abrasives and eliminate turbulence. 888/477-5769, [www.kroyind.com](http://www.kroyind.com); Expo booth 8161.



### Kuriyama of America Inc.

Tiger high-pressure discharge and suction hoses feature flexible EPDM/polyethylene construction for chemical resistance and durability. Designed to be flexible even in cold weather, the hoses have a UV and weather-resistant exterior and synthetic yarn reinforcement to resist kinks in tight bends. 847/755-0360, [www.kuriyama.com](http://www.kuriyama.com); Expo booth 32.



### Del Zotto Products

The Hydra-Brute unloader is designed for mounting on single, tandem or tri-axle trucks with bed lengths from 16 to 24 feet. Available in either 14,000- or 20,000-pound capacity, features include wood or "Rumber" decking, double-action hydraulic outriggers with safety load locks, monorail boom and protected DOT-approved lighting. The unit also has hydraulic planetary-powered in-and-out drive with auto shutoff, 20-inch, 3-way remote control, 3-spool multi-pak solenoid valve and hydraulic oil reservoir, including oil level gauge, suction strainer and inline filter. Options include side toolbox, slide rails with ratchets, swing-out design for up to 10-foot wide loads, pintle hitch, electric and air hookups. 218/384-3066; [www.delzotto.com](http://www.delzotto.com); Expo booths 5025, 6025.



### SVE Portable Roadway Systems Inc.

The TrakMats ground cover system is engineered to move work vehicles across lawns, golf courses, wet ground, and other soft surfaces without getting stuck or damaging the surface. Made from 100 percent recycled HD polyethylene plastic, the mat's light color stays cooler in summer. Black mats



are available when grass protection is not a concern. Mats are manufactured with power cylinders for traction and hand cut-out for easy handling. A variety of sizes are available. 800-762-8267, [www.trakmats.com](http://www.trakmats.com); Expo booth 3031.

## Grease Interceptors

### Ashland Trap Distribution Co.

The APGI Series grease interceptor is designed to separate grease, oil, fats and other sediment from large commercial and industrial sources. Made of high density polyethylene, the unit is corrosion and acid resistant, has a non-skid 3/4-inch cover, can be installed above or below ground, and is available with steel or aluminum non-skid thread plates. 800/541-8004; Expo booth 3011.



## Chemicals and Deodorizers

### Custom Biologicals Inc.

Mop 'n Treat is a biological mop water treatment for restaurants and taverns. Designed to degrade organic material in cracks, crevices and drain lines, the treatment



disrupts the habitat that flies require for production, and removes food sources for other insects, including roaches.

The once-a-day treatment is compatible with other floor cleaners. One tablet per mop bucket dosing eliminates waste from spillage. 561/998-1699; [www.custombio.com](http://www.custombio.com); Expo booth 7004.



### Earth Friendly Chemicals Inc.

QuikCharge SDC is a Category IV disinfectant that Utilizes molecular technology to provide 24-hour residual protection against standard and resistant bacteria, including MRSA. The active disinfectant ingredient does not promote bacterial resistance and

is non-toxic, odorless, colorless, non-corrosive, non-flammable and compatible with other disinfecting and cleaning chemicals. 757/226-2750, [www.efchem.com](http://www.efchem.com); Expo booth 5047A.

### J&J Chemical Co.

ART Blaster is a biodegradable, environmentally friendly graffiti remover that cleans paint, pen, crayon, tar, soap scum, grease, calcium buildup and many more substances from portable restrooms. Even pencil wipes off. The spray also leaves a protective sheen to guard against new graffiti. 800/345-3303, [www.jjchem.com](http://www.jjchem.com); Expo booth 2009.



### OMI Industries

Ecosorb odor neutralizer promises to remove a full spectrum of organic and inorganic odors, rather than masking them with perfumes or chemicals. The molecular formula is designed to break down odors, and requires no water when used with Vapor Phase equipment. 800/662-6367, [www.omi-industries.com](http://www.omi-industries.com); Expo booth 18038.

### Worldwide Organics

The Purple Magic Toss-N-Go Pac restroom deodorant is designed for long-lasting odor control and fragrance. The environmentally friendly purple dye contains all natural ingredients. Each packet is portion controlled. 866/683-7565, [www.naturessolution.com](http://www.naturessolution.com); Expo booth 20033.



### Safe-T-Fresh Deodorizers

Bio-Quickscent uses the enzymatic action of several anaerobic and facultative bacterial strains to break down waste and paper tissue in portable restrooms. The deodorizer is environmentally safe and contains no harsh chemicals. 877/764-7297, <http://safetyfresh.com>; Expo booth 8125.



### Lenzyme Inc.

Septic Scrub is a bacterial formulation that attacks biomat buildup in drainfields. The product consists of sodium carbonate peroxyhydrate and a blend of bacteria designed

to re-establish lost bacteria. The blended bacteria also help to break down paper fibers, grease, pectins and other organic substances that may be left in the field. The material is applied to laterals by pouring the powder in and adding water to flush it into the field lines. The material reacts with the biomat and sulfides that build up on the top of the soil bed. This mild reaction causes the biomat to break apart and restore percolation to the soil bed. 800/223-3083; Expo booth 6151.



### Roebic Laboratories Inc.

Grease Trap treatment is a liquid bacteria, designed to degrade fats, oils and grease in food processing/preparation wastewater systems by controlling grease build-up and odors, when used regularly. The formula contains 10 strains of high enzyme-producing Bacillus bacteria and no free enzymes, caustics, acids or other harsh chemicals. The product is available in 1- and 5-gallon containers. 203/795-1283, [www.roebic.com](http://www.roebic.com); Expo booth 9233.







## Service Vehicles

### FMI Truck Sales & Service

The Electra-Vac hybrid portable restroom service truck is designed to provide vacuum without the truck engine running. Initial testing, based on an average 40-stop service route, has shown fuel savings of between



\$4,500 and \$6,000 per year. The self-contained, high-output charging system allows the PTO drive batteries to recharge between stops. The system does not require outside charging support and substantially reduces noise levels while pumping. [800/927-8750](tel:8009278750); [www.fmitrucks.com](http://www.fmitrucks.com); Expo booth 2209.

### Marsh Industrial

Mounted on a two-wheel-drive Ford F-550 chassis, the 950-gallon portable restroom service unit features a 650-gallon



waste/300-gallon freshwater tank with 12V wash down pump and 50 feet of 5/8-inch garden hose. The unit also has 2-inch bucket fill lines on both sides, aluminum toolboxes with shelves mounted at the front of the full-length fenders and a folding portable restroom rack at the rear. The unit is equipped with a 194-cfm pumping system with 4-way valve for vacuum and pressure offloading, 2-inch suction and 3-inch discharge line. [800/952-1537](tel:8009521537), [www.marshind.com](http://www.marshind.com); Expo booths 5217, 6215.

### Bosserman Tank & Truck Equipment LLC

The VT1000-FB-2 service truck has 750-gallon waste and 250-gallon freshwater stor-



age capacity in its Amthor aluminum, two-compartment flat-bed tank. The truck can carry eight units, or up to 10 with the included rear-lift platform. Mounted on a Ford LCF chassis, the service unit includes a Masport HXL3V vacuum system, 2-inch suction hose with Greenleaf ball valve wand and a 3-inch discharge with a Greenleaf ball valve on the passenger side. [419/396-1570](tel:4193961570), [www.bossermantankandtruck.com](http://www.bossermantankandtruck.com); Expo booths 5003, 6003.

### Tank Technologies & Supply Company LLC

The Kenworth T300 portable restroom service truck features a 1,700-gallon Progress Tank mounted on a non-CDL, 22,000 GVW chassis with 19.5-inch tires and hydraulic brake. The truck is among many custom-built



vehicles available in a variety of chassis and tank sizes, ranging from 300- to 550-gallon slide-in units, 800- to 2,200-gallon restroom service trucks and 1,000- to 6,000-gallon vacuum trucks. [888/428-6422](tel:8884286422), [www.tanktec.biz](http://www.tanktec.biz); Expo booth 4133.

## Drain Cleaners

### Duracable Mfg.

The Esquire model DM138 drain cleaner is designed for indoor lines from 1.25 up to 3 inches in diameter, and can be quickly broken down into two, easy-to-carry components. The cleaner features a 1/4-hp motor, foot pedal, drain hole in the reel, switch guard, detachable handle, non-marring rubber pads, heavy-duty 20-amp switch, self-adjusting head bearing, horizontal running legs, and a complete welded frame. It runs at 230 rpm and comes with a 3/8-inch by 90-foot cable on a 14-inch reel. [866/587-1597](tel:8665871597), [www.duracable.com](http://www.duracable.com); Expo booth 3165.



## Dewatering and Dredges

### Prime Solution Inc.

The Rotary Fan Press biosolids dewatering system and Inline Rotary Thickener are totally enclosed to eliminate odors, and feature few mechanical parts for low energy consumption and maintenance. The compact units are designed to operate with minimal supervision. [269/673-9559](tel:2696739559), [www.primesolution1st.com](http://www.primesolution1st.com); Expo booth 9103.





## Aqua-Zyme Disposal Systems Inc.

The 30-cubic-yard ADS Dewatering Unit can be filled with 25,000 gallons of sludge or grease trap waste at 1 1/2- to 2-percent solids in about two hours and can pass the paint filter test within 24 hours. The unit is designed to dump clean and is completely shop assembled. [979/245-5656](tel:9792455656), [www.aqua-zyme.com](http://www.aqua-zyme.com); Expo booth 163.

## Liquid Waste Technology

The Pit Hog PH10-40 remote-control electric dredge has a working depth of 15 feet, weighs approximately 5,900 pounds and measures 23 feet, 1 inch long, 7 feet, 6 inches wide and 6 feet, 10 inches high. Powered by a 460-volt, 60 Hz motor, the unit has a 40-hp submersible pump. Made of structural steel, the dredge is designed for manned or unmanned operation with computer or manual controls. The wireless remote features slurry pump on/off, auger



on/off, travel forward on/off, travel speed, hoist up/down and pump speed.

[800/243-1406](tel:8002431406), [www.lwrtphog.com](http://www.lwrtphog.com);  
Expo booths 5195, 6195.

## Plugs

### Real-Tite Plugs Inc.

Counter sunk, thumb bolt, hex head and steel top plugs are available



in sizes from 1 1/2 through 4 inches. Self-contained and code approve, the plugs eliminate the need for threaded adapters. They can be removed while installing fixtures, used to permanently seal openings or be saved and reused again. [800/877-0610](tel:8008770610), [www.real-titeplugs.com](http://www.real-titeplugs.com); Expo booth 3193.

**Coagulants and Flocculants**  
for Septic, Grease, Municipalities and Industry

**Call Toll-free:**  
**877.771.6041**

**Aqua Ben Corporation**  
1390 N. Manzanita St. • Orange, CA 92867  
[www.aquaben.com](http://www.aquaben.com) • [sales@aquaben.com](mailto:sales@aquaben.com)

- Dewatering polymers for all dewatering equipment
- All forms: Dry and Emulsion
- Variety of packaging sizes to meet customer needs
- Both East & West coast shipping points
- Expert technical staff
- Specific solutions for our customers

**Booth 4056**

**Celebrating 30 YEARS in business**

Save Money  
Save Time  
Save Polymer

**SOFTWARE FOR THE INDUSTRY**  
**Summit™ XP Service Profit Builder™**

- Work Orders
- Dispatching
- Simplified Routing
- Instant Mapping
- Inventory Control
- Receivables
- Commissions
- Repeat Business
- History & Reminders

**Booth 116**

**Celebrating our 25th Anniversary!**

**summit**

**Voted Easiest to Use!**

**Basics system starts at \$800**

Demos on line: [www.ritam.com](http://www.ritam.com)

Demo DVD/CD also available

**Ask about our:**

- Fleet Maintenance software for vehicles, equipment, parts and services
- Incentives software for employee productivity tracking
- Sales Contacts software for salesreps

**In the Portable Restroom business too?**  
Ask about our Summit™ XP Rental Profit Builder™ software

**Ritam Technologies • 800-662-8471 • [www.ritam.com](http://www.ritam.com)**

*"Bringing Technology and Greater Profits to the Industry" ... Since 1981*

**Put our 25 years of experience to work for you**

**Non-CDL**  
**19,500 GVW to 66,000 GVW**  
**Septic / Grease Trap**  
**Portable Restroom**  
**Vacuum Service**

**Complete 'Work Ready' Units Priced As Low As \$66,200**

Contact: Mark C. Langworthy  
e-mail: [mlangwor@tanktruckservice.com](mailto:mlangwor@tanktruckservice.com) [www.tanktruckservice.com](http://www.tanktruckservice.com)

**Tank Truck Service & Sales, Inc.**  
25150 Dequidre, Warren MI 48091

**800-261-9009**





#5207, 6209



*We Have Financing Available!*



2007 Sterling AUTO TRANS 2500/300 Gallon Aluminum, PM80 pump Cat 275HP, Allison Auto, Exhaust brake, Traction Control.

**\$92,000**



2007 Sterling 2500 gallon Steel Jurop pump, Mercedes 260 HP, 10 spd, engine brake, Traction control ALUMINUM HOSE TRAYS.

**\$77,500** Plus FET



2007 Sterling AUTO TRANS 4000 gallon steel tank, Jurop pump, Cat 330HP, Allison auto 18K ft, 40K rear exhaust brake, ALUMINUM TRAYS.

**\$102,000** Plus FET

Now In **STOCK!**

On-The-Lot Selection *Call For Prices & Pre -Approval!*

Call Us Today Toll-Free:

**888-201-9166**

Septic - Portable Toilet - Hoisted Vacuum - Slide-Ins  
**New!** Units Available / Trade-ins Accepted! / Financing & Lease Plans



**Del Vel Chem**  
C O M P A N Y

*Offering a Complete Line of  
Portable Toilet & Septic Needs*

Introducing our two newest **All-Natural** Products!

**Nano Eliminator Deodorant and  
Graffiti Remover**

**Non-Toxic  
Environmentally Friendly**



See us in  
Booth #7122

*Servicing the Industry with Pride Since 1994*

250 Old Marlton Pike • Medford, New Jersey 08055  
609-714-2424 • Fax: 609-714-3030 • 800-699-9903

# FINANCING

## FOR ALL YOUR NEW & USED EQUIPMENT

### GIVE US A CALL TODAY! 866-769-2345



Booth 7070

**31 YEARS OF EXPERIENCE  
WORKING FOR YOU!**



**CAPITAL PARTNERS**

101 N. Main Ave. Suite 215  
Sioux Falls, SD 57104  
www.yourcapitalpartner.com  
866-769-2345

- Application Only to \$250,000.00
- Simple Approval Process
- Lease or Loan Options
- Aggressive on Used Equipment
- Start-up Programs
- Flexible Financing Available

**YOUR ONE STOP  
FINANCING PARTNER**

*Competitive Pricing, Simple Processing,  
Honest Answers*



**Appearance  
Performance  
Quality  
Since 1939**

## ***Conde PowerPaks***

### ***More Power To You***

**Conde gas powered vacuum units  
are compact, powerful, and  
ready to install for instant vacuum**

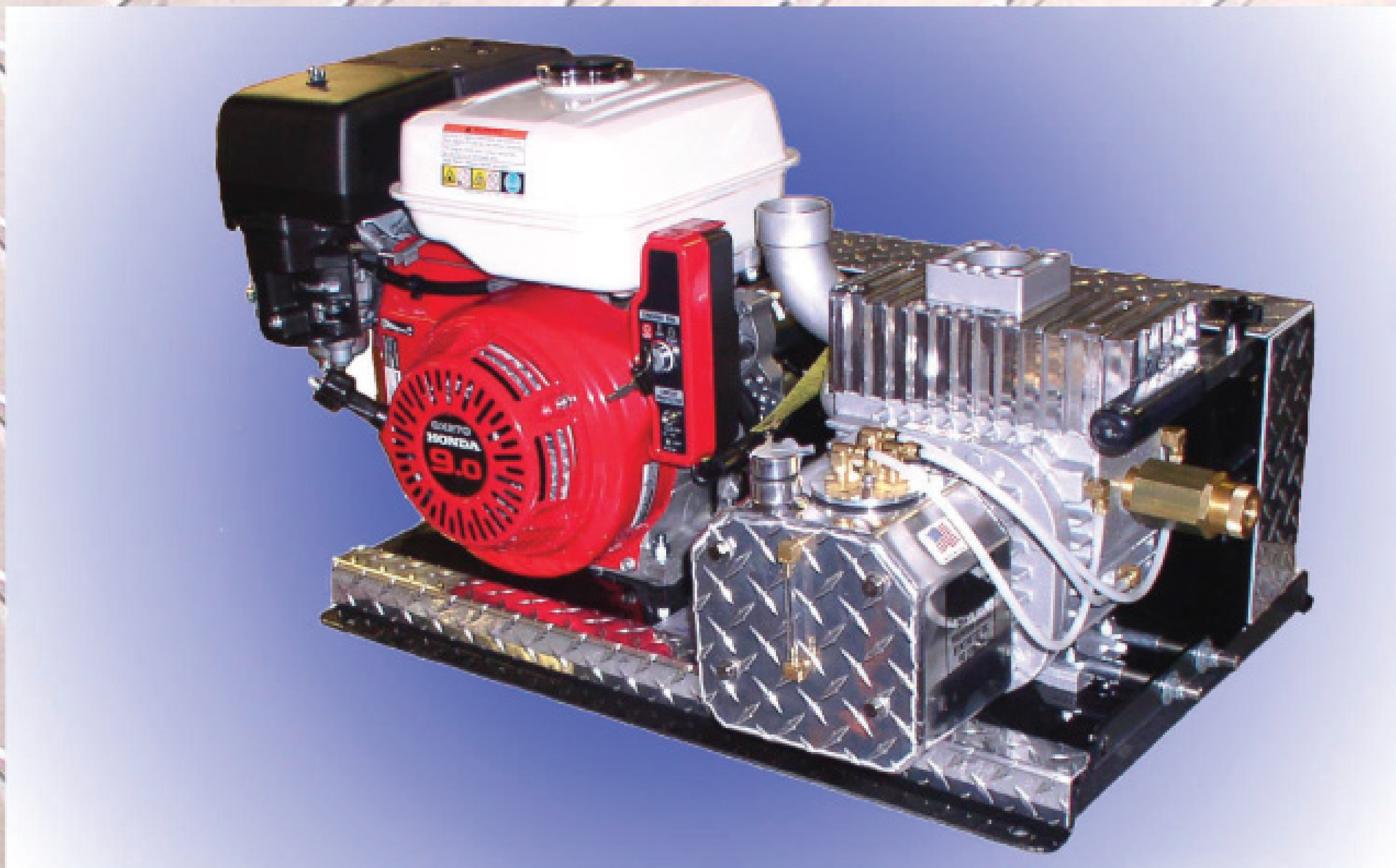

**Booth 8109**

**Westmoor Ltd.**

P.O. Box 99  
Sherrill, New York 13461

**Call Toll Free 1-800-367-0972**

On The Web At: [www.westmoorltd.com](http://www.westmoorltd.com) E-mail: [pumps@westmoorltd.com](mailto:pumps@westmoorltd.com)





# On the Road Again

**East Texas pumper LASSO kicks up some dust and wears through a lot of tires serving customers in an expansive territory**

*By Richard Ryman*



The fleet at Lake Area Septic & Sludge Operations (above) racks up plenty of miles roaming East Texas to serve customers. Inset, owner Jeff Martindale checks the oil on one of the vehicles. (Photos by Sharon Brooks)

**J**eff Martindale is a Texan. It comes as no surprise, then, that his septic and portable restroom company serves a large area, or that he has large ambitions.

A self-described workaholic, Martindale, 52, runs a five-man septic and portable restroom operation in East Texas, northeast of Houston and just west of the Louisiana border. His seven-county service area — at 5,899 square miles — is larger than Connecticut, Delaware or Rhode Island.

“I don’t care how big I get. There is no limit,”

says the owner of Lake Area Septic & Sludge Operations, also known as LASSO, of Jasper, Texas. “We are going to grow this business and we are going to take care of it and we are going to keep it. It isn’t going away as long as we are here.”

### HALF SEPTIC, HALF PORTABLES

LASSO’s business is about evenly split between septic and portable restroom operations. The company supplies portable restrooms for oil businesses and festivals, rushes trailer-loads of portable restrooms to natural-disaster sites and hopes to increase its septic business by collecting sludge from municipal waste-treatment plants.

“I think the toilets will probably outgrow septic, but it’s not going to be right now. I can’t pick one over the other. They complement each other,” he says.

Martindale began the

portable restroom business while getting his land application site operational. He disposes of septic waste on a 30-acre field, while portable restroom waste must go to a wastewater treatment plant.

Martindale is working to get an additional 25 acres certified for application so he can begin collecting sludge from municipal treatment plants. He says there are a number of plants within 20 miles of his business that are looking for a place to dispose of their sludge. Two have committed to him and a third is considering it.

“They are having to ship it so far. It costs,” he says.

Martindale is increasing his disposal area because he expects there will be more metals, such as lead, mercury and chromium, in the waste.

“Your metals will get up on you if you have a small site and go to dumping all that on it,” he says. “You can’t just keep pounding them in there. They don’t go away.”

## Profile

### Lake Area Septic & Sludge Operations (LASSO)

Jasper, Texas

**Owner:** Jeff Martindale  
**Founded:** 1998  
**Employees:** 4  
**Services:** Residential and commercial pumping, portable sanitation  
**Service area:** Jasper, Newton, Hardin, Orange, Polk, Tyler and Angelina counties; wherever needed for disaster services







Jeff Martindale (left) checks with technicians Mike Dickerson and Thomas Ward as they pump a residential septic system. Martindale is often on the road, and flies his own plane to save travel time between appointments.

Martindale says he will have enough certified acres for now, but he expects to need more. Fortunately, he owns about 300 acres, so expansion is possible.

But getting permits in East Texas is difficult.

"You can get one in West Texas; they don't have any water," he says. "We have a lot of freshwater."

He is only eight miles from the 114,500-acre Sam Rayburn Reservoir and has a monitoring

well on his site.

Texas law prohibits growing anything for human consumption on the land within 18 months of application. Martindale grows hay. Some he feeds to his cattle and some he sells.

#### MILES AND MILES OF TEXAS

Texas being Texas — that is large — quick transportation is problematic.

Martindale is a pilot and uses a Piper Super Cub that he keeps in a pasture at his home for

**"CUSTOMER SERVICE IS ALL I'VE GOT TO SELL. IF I DON'T DO WHAT I'M SUPPOSED TO DO, YOU WON'T CALL ME BACK."**

**Jeff Martindale**

some business. For example, when he needs to take a truck to the dealership, which is three hours away by road, he'll fly down and pick up his driver and bring him home.

"It saves you time and it's not as boring as driving," he says of flying.

But the airplane doesn't help when it comes to running routes and making deliveries and pickups.

"I just came off a 47.9-mile carry-to," he said the day of this interview. "I'm on the road all the time. I did 295 miles the other day. That was just me (not counting his other drivers)."

As much as possible, he tries to do restroom service on weekends and septic work on weekdays.

Distance and state regulations are factors in routing and starting times. Because waste can't be mixed, portable restroom service routes that cannot wait until the weekend start early in the morning, between 1 and 4 a.m.

"Starting with toilets that early, there's nobody using them, no traffic, no school buses, nobody parked in front of them," he says.

The drivers will return before noon, at which point they begin septic routes, the most frequent of which he tries to keep on a regular rotation. Martindale says he works 13 to 14 hours a day. His employees "may work 12 hours a couple of days a week. I work more than any of them."

Martindale keeps three trucks on the road, including a 2001 International 4300 with 2,000-gallon aluminum tank, a 2004 International 4300 with 2,500-gallon aluminum tank built by Keith Huber Inc., a 2007 Kenworth T300 with 2,000-gallon stainless steel tank built by Best Enterprises Inc., and a 1998 Ford F-450 with a steel slide-in unit from Lely Manufacturing Inc.



Dickerson (far left) works on a grease trap in Jasper, Texas. At left, Ward and Dickerson pump a residential septic system.





Land application is in progress. In Texas, food crops can't be planted on land where seepage has been spread for 18 months.

### THE RIGHT STUFF FOR SERVICE

He says the septic work increases in winter. Texas roads are good, but getting off the road that time of year or in rainy weather can be a problem.

"My trucks are good enough and of a quality we can pump 125 feet. We don't like to pull that far, but I'm not going to drive 75 miles and not do it. It ain't fast, but it's better than going home with nothing," he says. "If it's wet, you've got to do it. You don't want to wreck the yard."

He also has a cargo trailer and three restroom transport trailers, two of which can carry 12 units and one that carries 20 restrooms or 30 hand-wash stations.

He has a 400-gallon waste/200-gallon freshwater slide-in unit by Lely Manufacturing Inc., 400 portable restrooms (8 handicap units) from PolyJohn Enterprises, Polyportables Inc. and Hampel Corp., and 30 portable hand-wash stations from PolyJohn.

Martindale decided to go into the portable restroom business after he determined another company providing services to the area could use some competition. At the time he was operating Martindale Tree Service, a right-of-way-clearing business that he has since sold to his son.

"I'm a workaholic. You probably don't know any as bad as I am," he says.

Martindale says it took about three years before the pumping businesses were running smoothly. He bought new portable restrooms as he could afford them, gradually expanding his reach.

### KEEPING THE CREW HAPPY

Martindale says his is a pretty big operation for the area. It's a competitive

**"I DON'T HAVE TURNOVER. ANY. NONE. I WORK. NONE OF MY PEOPLE WORK MORE THAN I DO. I TRY TO DO THE WEEKENDS AND TRY NOT TO LET THEM DO THAT."**

**Jeff Martindale**

business, but he says he's got a good crew that knows the business and some part-time help available when he needs it.

"I don't have turnover. Any. None. I work. None of my people work more than I do. I try to do the weekends and try not to let them do that," he says.

Other than a Commercial Drivers License, no special

training is required by the county or state. He teaches workers how to do their job, and his wife, Nadia, who is a nursing instructor, takes care of health-safety training.

"They go and they learn. We do that for some time. I want them to know how I do it, and that's how I want it done," he says.

High oil prices have meant more work for

LASSO. Drilling is active in East Texas and the need for portable restrooms is high. The payout is good, but it's a segment of the business that requires more work than most.

"They may use them a week; they may use them a month; they may use them a year," Martindale says. "They are always moving and they are not good roads, either."

He says he had probably 80 units in oil fields last spring, and he charges daily rates because the roads are so marginal.

"I charge mileage, too, because you have to," he says. "They are not on a paved road and they want them now. It's demanding and they just are everywhere. You've got truck traffic and it doesn't ever quit in the oil field."

Martindale said daily rate totals drive his monthly bill per restroom to about four times his standard monthly service fee.

"You have to keep up with exactly what day you put them out. They'll move from field to field or rig to rig regularly."

For all that, he says, it's worthwhile business.



Above, Martindale's restrooms are kept inside a warehouse, enabling them to stay cleaner and last longer. At left, technician Mike Dickerson gets ready to spray down a portable restroom.





Jeff Martindale discusses the day's work with administrative assistant Debbie Jones, while Martindale's daughter Ericka Stewart (with her daughter Emma Kate Stewart) works in the background.

### DOING A GOOD DEED

Martindale does other things that keep people thinking of him. He says a couple of years ago there was a large church fire. He loaded up some portable restrooms and dropped them off for the guys fighting the blaze.

"They don't pay for that. I left them out until they got through with them," he says.

Otherwise, festivals and fishing tournaments account for a lot of his business, and he's always looking for new events and new areas to work. He likes to start with portable restrooms in a new area. That leads to septic work.

"People are going to call. They say 'we see your trucks everywhere,'" he says.

He recently serviced the Tyler County Dogwood Festival in Woodville. Again, he got the business because he was willing to provide the requested services. One of the festival's concerns was that the company that did the job before left restrooms sitting around the courthouse square for several days after the event.

"They called me and asked me what I'd do it for. It cost them a little more, but when they get done with (the restrooms), I go get them," he says. "When you build a company and are doing it yourself, you can say 'yes' and it's 'yes,' and you can say 'no' and it's 'no.' You don't have to have a meeting.

"Customer service is all I've got to sell. If I don't do what I'm supposed to do, you won't call me back." ■

### MORE INFO:

**Best Enterprises Inc.**  
800/288-2378  
www.bestenterprises.net

**Hampel Corp.**  
262/255-4540  
www.hampelcorp.com

**Keith Huber**  
800/334-8237  
www.keithhuber.com

**Lely Manufacturing Inc.**  
800/334-2763  
www.leyus.com

**PolyJohn Enterprises**  
800/292-1305  
www.polyjohn.com

**PolyPortables Inc.**  
800/241-7951  
www.polyportables.com

## LASSO Answers the Call for Emergency Service

The explosion of the space shuttle Columbia over Texas and Louisiana in February 2003 required fast action for state and federal search and investigation teams. That meant services had to be found just as quickly.

"They needed it now and I happened to have a buddy on the emergency management team here," says Jeff Martindale of Lakes Area Septic & Sludge Operation, explaining how his company became a go-to provider of portable restrooms for the U.S. Forest Service and the Federal Emergency Management Agency.

The feds established a camp at Hemphill, 35 miles from Martindale's office in Jasper, for its disaster workers. Martindale brought in 102 portable restrooms and 20 hand-wash stations, set up a tent and went to work. Restrooms were serviced several times a day for 79 days, complete with pumping, washing, scrubbing and drying.

It was a lot of work, he says, but that's why he was there.

"They are paying me to do what they want. I want to go back. I don't want your money this time. I want it every time," he says.

Martindale and two employees lived in the camp with everyone else, sleeping in small, one-man tents. They were only about 35 miles from home, but Martindale says they might as well have been 1,000 miles away, because they worked around the clock, with never enough time to go anywhere.

Martindale says he received a letter of commendation from the U.S. Forest Service and two years later, when Hurricane Katrina hit Louisiana and Mississippi, he got the call.

This time he set up at Camp Shelby, 71 miles north of Biloxi, Miss., with 140 portable restrooms and 30 hand-wash stations. They arrived two days after the hurricane and stayed for 62.

"They called me Friday night and wanted me to be there Sunday, and I left," he says.

The hardest part, he says, is getting there and back. He can move 52 portable restrooms and 30 hand-wash stations at a time using multiple trucks. He says if he can't haul enough units to the site, he'll buy new ones locally.

He's also learned to make sure to carry adequate spare parts and to make sure they are the right parts. He bought a cargo trailer for the trip to Mississippi. He thought it was loaded with all the necessary parts until they got a flat tire on the trailer while on the Atchafalaya Bridge, which is actually a series of bridges over the Atchafalaya River and swamp in Louisiana. Turned out, the spare tire for the new trailer had the wrong rim.

"It was night. There was no place to go. We stayed on the edge (of the road) for four hours. I learned something there. I keep my trailers loaded (with parts)," he says. "I guarantee you, they are checked."

Martindale believes it's important for him to be there personally, to make sure things are being done right, and once there, to stay until the job is done. He says he's got dependable employees at home who can keep the routine operations rolling as they should, including daughter Ericka, his full-time secretary.

Martindale says he has no qualms about working with the federal disaster agency, which received a lot of criticism in the wake of the hurricanes.

"They know what it costs to do business and they pay you," he says.

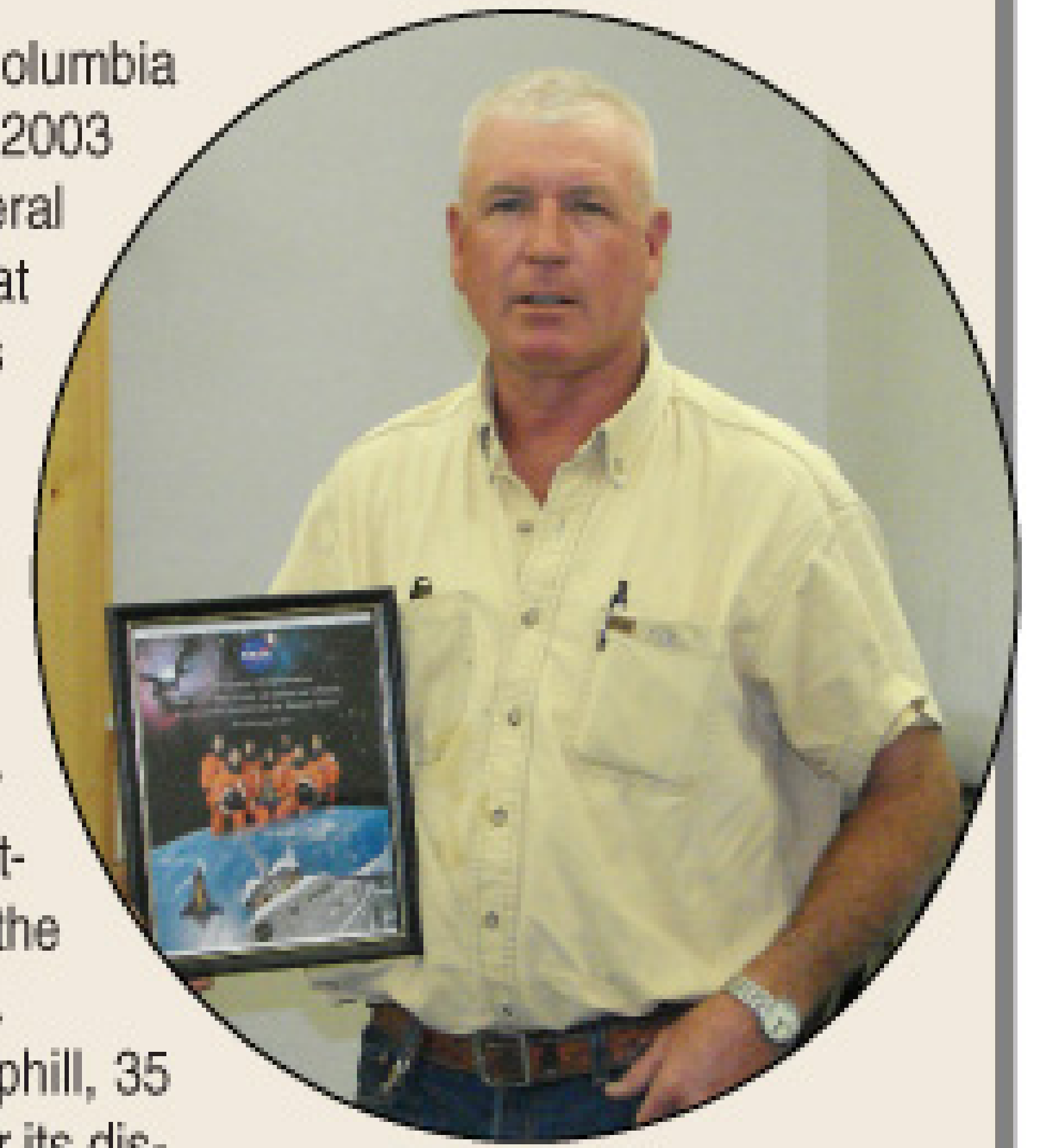

Martindale received a photo of the Columbia shuttle crew after working 79 days in recovery efforts following the space shuttle's explosion.



PORTABLE TOILET  
SERVICE UNITS  
SLIDE IN UNITS  
HOISTED UNITS  
ROLL OFF UNITS  
CUSTOM UNITS

[www.pikrite.com](http://www.pikrite.com)

# Do Your Shopping At Pik Rite and Save



**pikrite**

Manufacturing & Sales - 60 Pik Rite Lane - Lewisburg, PA 17837

**1-800-326-9763**



#4202-4205, 4207, 4208

**SmithCo**  
SIDE-DUMP TRAILERS

# SIDE DUMP

Call **800-779-8099**  
[www.sidedump.com](http://www.sidedump.com)

30902 C38  
Le Mars, Iowa 51031



#5219 & 6219



CP-20 Offroad



SHV Series



DT Series



MHV Series



S Series

*Manure, Slurry, Sludge, Green Waste, Food Residuals, Compost, SmithCo Hauls it All.  
Stock Pile, Spread, Stability, Selection, Service...SmithCo*

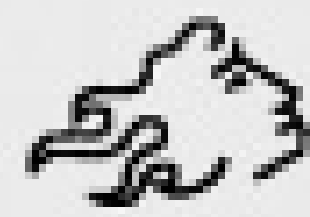

Placing a value on what you've built.

*A knowledgeable buyer can make all the difference.*

We own a portable restroom business in Southern California and are actively looking for potential acquisitions across the U.S. So if you have built a quality business in the portable sanitation industry, we would like to meet with you.

At Prometheus, we specialize in acquiring profitable, middle market companies in route businesses.



And we are especially focused on the portable sanitation industry. Here's why you should contact us:

## CAPITAL

Whether you are looking to sell your business or are looking to grow, you need capital. We are a cash buyer and can complete a transaction quickly.



Also, our relationships within the financial community provide access to additional sources of capital necessary to grow

your business. If you are interested in selling a portion or all of your business or if you believe a committed equity partner can help you achieve the vision you have for your business, we would look forward to meeting with you.

**Nicholas Peters**  
President and CEO

**Chris Suh**  
Director

**Chris Russell**  
Principal



**PROMETHEUS**

TWO CONCOURSE PARKWAY • SUITE 155 • ATLANTA, GA • 30328 • PHONE: 770.395.9091

[www.prometheuspartners.com](http://www.prometheuspartners.com)





2003 Peterbilt  
379

**\$94,800**  
or  
**\$1,830/month**

3,600-Gal. Steel Vacuum Tank  
Jurup LC420 Vacuum Pump  
Cat C-12 Diesel, 380 HP • Stock #9209



2006 Chevrolet  
C8500

**\$72,000**  
or  
**\$1,294/month**

2,500-Gal. Vacuum Tank  
Masport HXL15 Vacuum Pump  
Duramax Diesel, 250 HP • Stock #9204



2002 Peterbilt  
379

**\$80,000**  
or  
**\$1,544/month**

4,000-Gal. Amthor Aluminum Vacuum Tank  
National F506CCW Vacuum Pump  
Cat C-15 Diesel, 475 HP • Stock #5363

**0% DOWN**  
WE FINANCE MOST CREDITS  
INCLUDING START-UPS!



2001 Mack  
CX613

**\$86,000**  
or  
**\$1,660/month**

4,000-Gal. US Tanks Steel Vacuum Tank  
Jurup Vacuum Pump  
Mack E7-427 Diesel, 427 HP • Stock #10138



2000 Sterling  
AT9500

**\$71,000**  
or  
**\$1,370/month**

4,000-Gal. US Tanks Steel Vacuum Tank  
Jurup Vacuum Pump  
Cummins ISM Diesel, 330 HP • Stock #10149

Equipment prices, specifications and availability subject to change. All equipment sold "as is, where is." Call for complete information on equipment and financing. Not all applications will be approved for financing.

**0% down financing available on over 450 work trucks and trailers!**  
**Call 866-472-4478 or visit [www.trucksathand.com](http://www.trucksathand.com) today!**

## Custom Dewatering Solutions

### COST-EFFECTIVE, TURNKEY SYSTEMS

Built to your specifications

Municipal • Industrial • Septage

Mobile Units • Skid Systems • Sales • Rentals

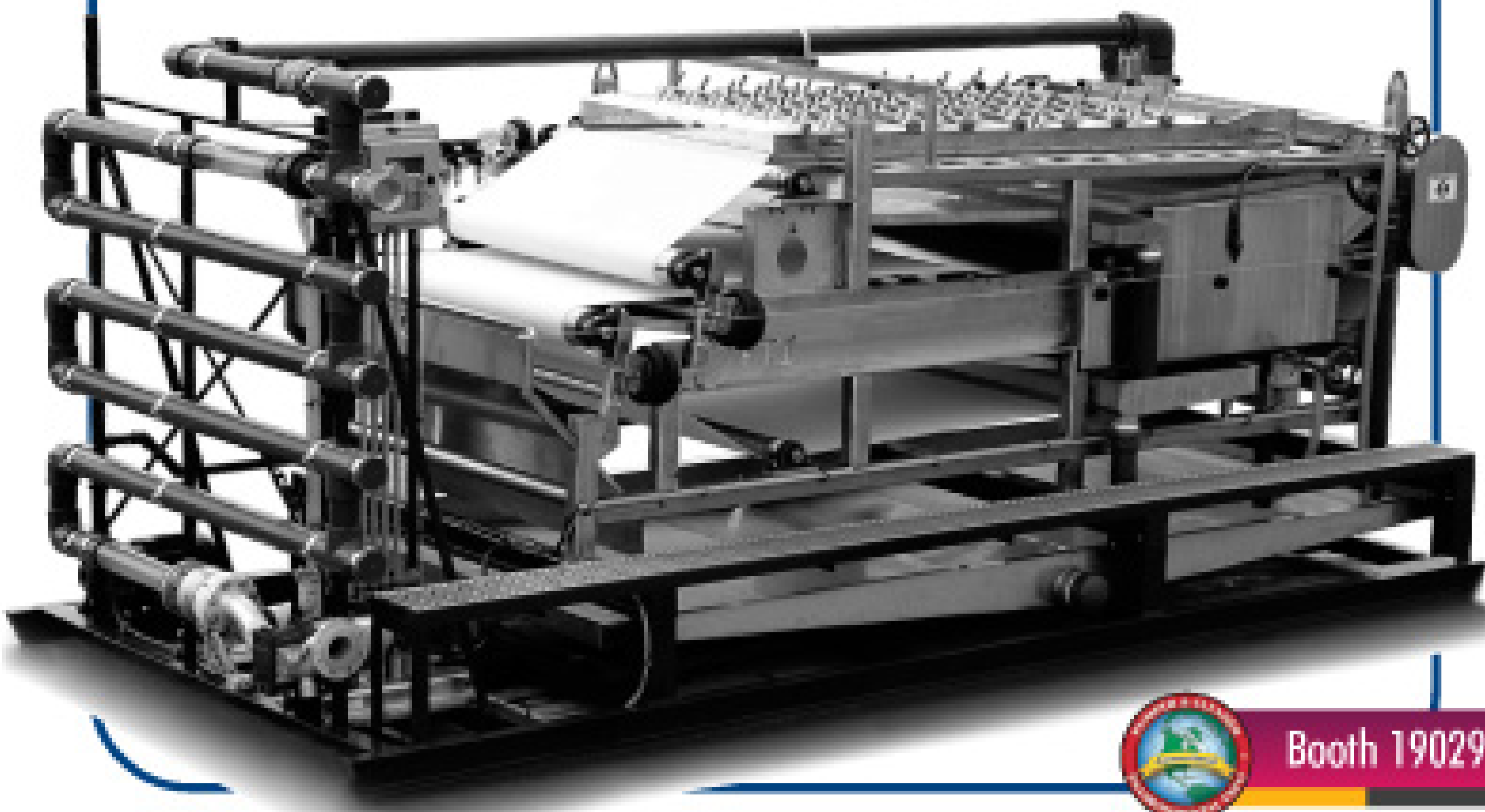

**Booth 19029**

**Call 269-673-9464**

**FRONTIER  
TECHNOLOGY,  
INC.**

609 N. Eastern Ave. • Allegan, MI 49010  
E-mail: [frontiertech@frontierfilter.com](mailto:frontiertech@frontierfilter.com)  
[www.frontierfilter.com](http://www.frontierfilter.com)  
Fax: 269-673-9629

**Booth 4010, 4013**



## Heavy-Duty Towable Backhoe

FAST • AFFORDABLE • COMPACT • DURABLE

**Gets you to the job site fast without secondary equipment!**

- 18 hp engine
- Digging depth up to 8 feet
- Hydraulic drive for job site mobility
- Torsion block suspension for easy towing
- Quality machine – Built to last!



**GO • FOR • DIGGER**  
**[www.gofordigger.com](http://www.gofordigger.com)**

1681 Halleck Rd. • Morgantown, WV 26505  
800-876-0738 • Fax: 304-296-5034



**Combined forces to better service your needs.**

**Septic Tank Additives**



"SK3" is a powdered septic tank additive that will boost biological activity and promote sludge settling. 20 x 1 year supply per case. Private label is available.

*Pumper Expo Special!*



**CHECK OUT THIS EXCITING NEW PACKAGING OPTION!**

**only \$6.00**  
per individual pkg.

*Pumper Expo Special!*

**Long Lasting Pink Cube**

**\$160**

per 4 x 5lbs.

"Pink Cube" is a commercial grade solid degreaser designed to last in hard to service liftstations & grease traps.



**Sewer Foam**

**\$59.75**

per pail

Reduce solids and hydrogen sulfide odors. An effective and economical approach to sewer maintenance.

**Complete Product Line**

**Septic Tanks**

**Lift Stations**

**Drainfields**

**Garbage Disposals**

**Odor Control**

**Portable Toilets**

**Cleaners**

**Urinals**

**BIG SHOT Toilet Treatments, Packets & Tablets**

Super Strength Concentrates –choose non-formaldehyde and formaldehyde blends in a wide array of fragrances— liquid, dissolvable tablets and packets.

**NEW fragrances - Clean Cotton and Wildflower!**

**NEW IMPROVED FORMULA!**



**Increased fragrance, dye & now with effervescence**

**BUY DIRECT AND SAVE!**

**CALL NOW!**

**1-800-423-5350**

or visit us online at [www.chempace.com](http://www.chempace.com)

See us at Pumper Expo booth #6075.

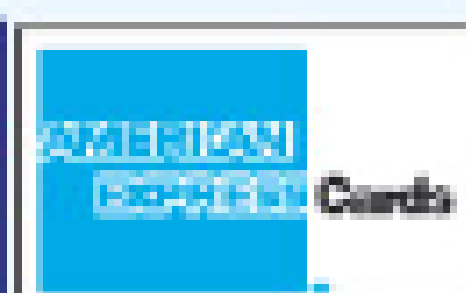

Private label is available for most products. Request brochures at time of order. For more information and products visit [www.chempace.com](http://www.chempace.com). Not combinable with other offers. No quantity limits. Call for details.





**Revolution:** rev-o-lu-tion / a sudden, complete or marked change in something

Experience the revolution in Louisville:



**Booth 1040**

Preview the Restroom Trailer revolution:

[www.restroomtechnology.com](http://www.restroomtechnology.com)



ADVANCED CONTAINMENT SYSTEMS INC.  
800.927.2271

# POWERflo

**1-800-758-4788**

**Vacuum Pumps & Tank Parts at WHOLESALE PRICES!**

## Juop PRODUCTS INC.



**PN84**  
• 252 cfm @ 18"  
• Air Cooled

**PN 23, 33, 58, 84, 106**  
IN STOCK.



**LC20**  
• 425 cfm @ 18"  
• Liquid Cooled



**R260**  
• 304 cfm @ 18"  
• Balast Port Cooling

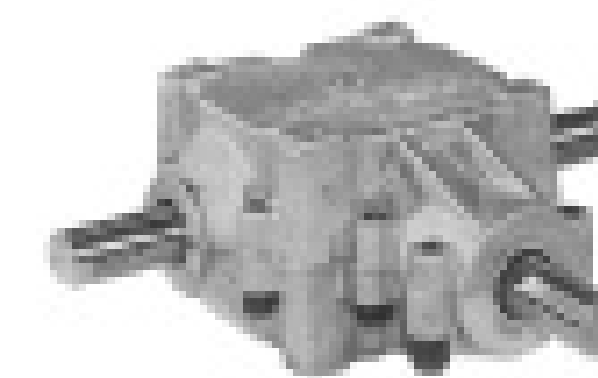

**RT Angle Gearbox**  
1" - \$199  
1 1/4" - \$299

### Lever Action Gate Valve

Brass  
2" - \$10  
3" - \$98  
4" - \$157  
6" - \$288



### Piston Action Gate Valve

Brass  
4" - \$69  
6" - \$183

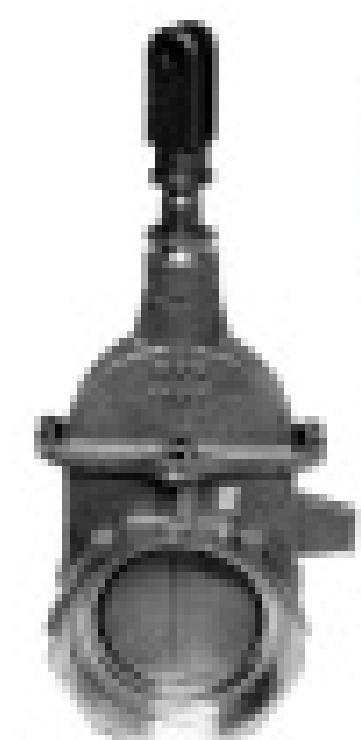

### Secondary

Nylon/Brass  
2" - \$160  
3" - \$206



### Manway Special Gasket in lid

20"  
35"

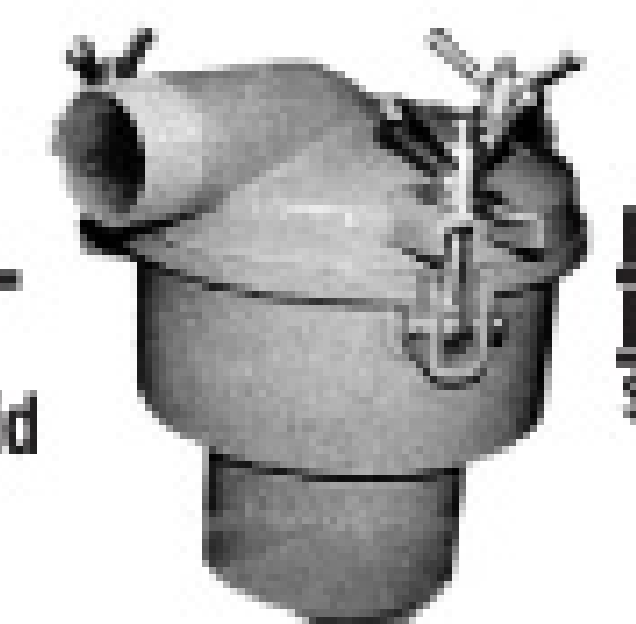
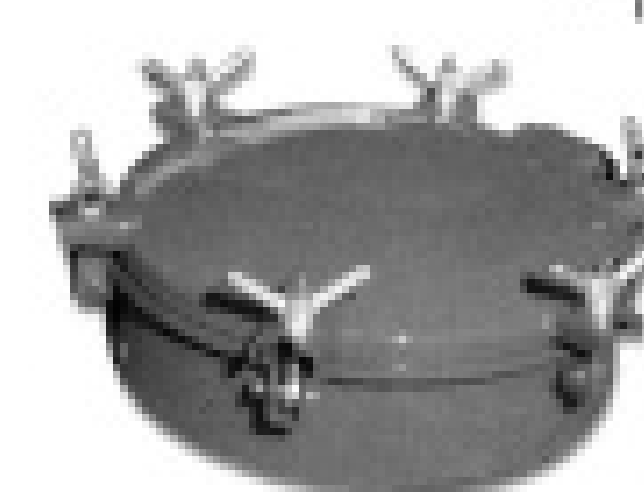

### Low Pro Primary

\$295

POWERFLO MODEL:	PF330	PF540
Air capacity displacement	258 cfm	390 cfm
Air capacity displacement @ 15" Hg	248 cfm	370 cfm
Minimum vacuum	95%	95%
Maximum pressure	30 psi	38 psi
RPM	1200	1200
Weight	308 lbs	357 lbs

### Performer Series PF540

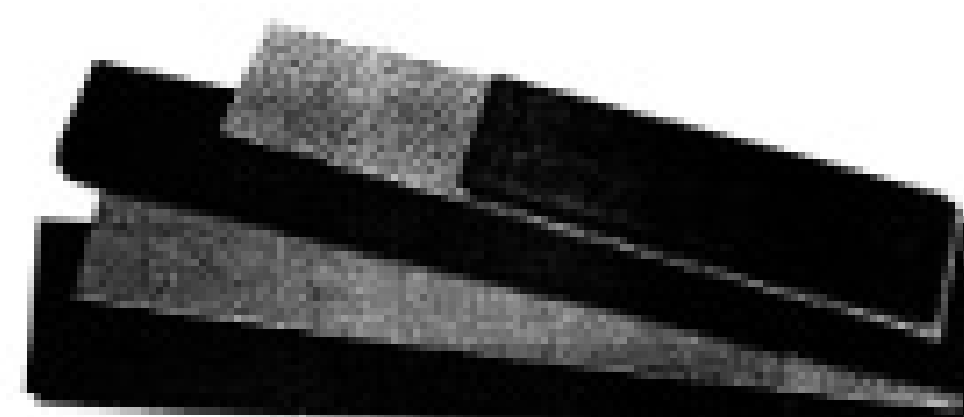

### Dura-Comp Pump Vanes

Exclusive manufacturer since 1991. 400 non-asbestos material. Long lasting, self lubricating, satisfaction guaranteed!



### DC-10

Heavy-Duty Washdown Pump

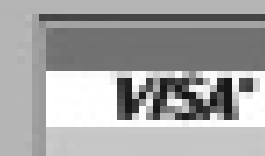

**POWERFLO PRODUCTS INC. • 2755 N. Gaviota Ave. • Signal Hill, CA 90806 • Phone: 562-997-0720 • Fax: 562-997-0724**



**1999 International 9100 M-11**  
Cummins, 280 HP, 9-speed, 350,000 miles. **NEW 2500-gallon** carbon steel tank. **NEW 240 CFM** vacuum pump, gearbox driven by PTO  
Price: .....**\$36,500**

**READY FOR IMMEDIATE DELIVERY**  
CALL US TOLL-FREE: **877-296-2555**



**2001 International 4900, DT466, 210 HP, 33,000 GVW, 7-speed, 236,000 miles**  
**NEW 2300 gallon carbon steel tank** with 3-inch inlet, 4-inch outlet, rear and top manways **NEW MEC 8000 Battioni pump** (242 CFM), gearbox driven, air PTO  
Price .....**\$ 43,900**



Price  
**\$150,000**  
+ F.E.T.



**NVE 506 4-inch pump 500CFM**  
and jetter, 10 gpm, 2400 psi

**2007 Sterling LT9500, MBE 450 HP, 10-speed, 20,000 front, 46,000 rear, compression brake, cruise, PS/AC**

**4200-gallon 2-chamber (4000 septic, 200 fresh) PROGRESS aluminum tank** with a full rear-opening door and a hoist.

Booth 6223, Truck spaces 5223 & 5225  
See our exhibit at the Kentucky Exposition Center in Louisville

**Used Unit**



**2005 Ford 550 power stroke diesel, automatic, 92,000 miles, PS/AC, Used 850-gallon aluminum 2-chamber tank, Anthony Lift Gate (holds total of 4 toilets, MEC2000 vacuum pump, 8 HP Honda 5 gpm demand pump.**  
Price: ..... **\$41,500**

**SPRING MOUNTS** decrease fatigue on your tank frame, universally mounts to most tanks, Easy bolt or weld on style, Compact, Heavy-duty stress relieved springs.



**Mounts with springs..\$80.00**  
**Springs alone .....\$10.00 each**

**WE**

**Wee Engineer**  
WITH IMAGINATION

**Wee Vac**

No more 3" sewer hoses running through restaurants. The Wee Vac fits through a standard doorway and can pump up to 45 gallons at a time. Wee Vac will even go up and down stairs when empty. It has a 3" female camlock so it can be downloaded into your truck. It features a 1 1/2" hose with wand & a 105 cfm, 110 volt vacuum pump.



**Price: \$1060.00**

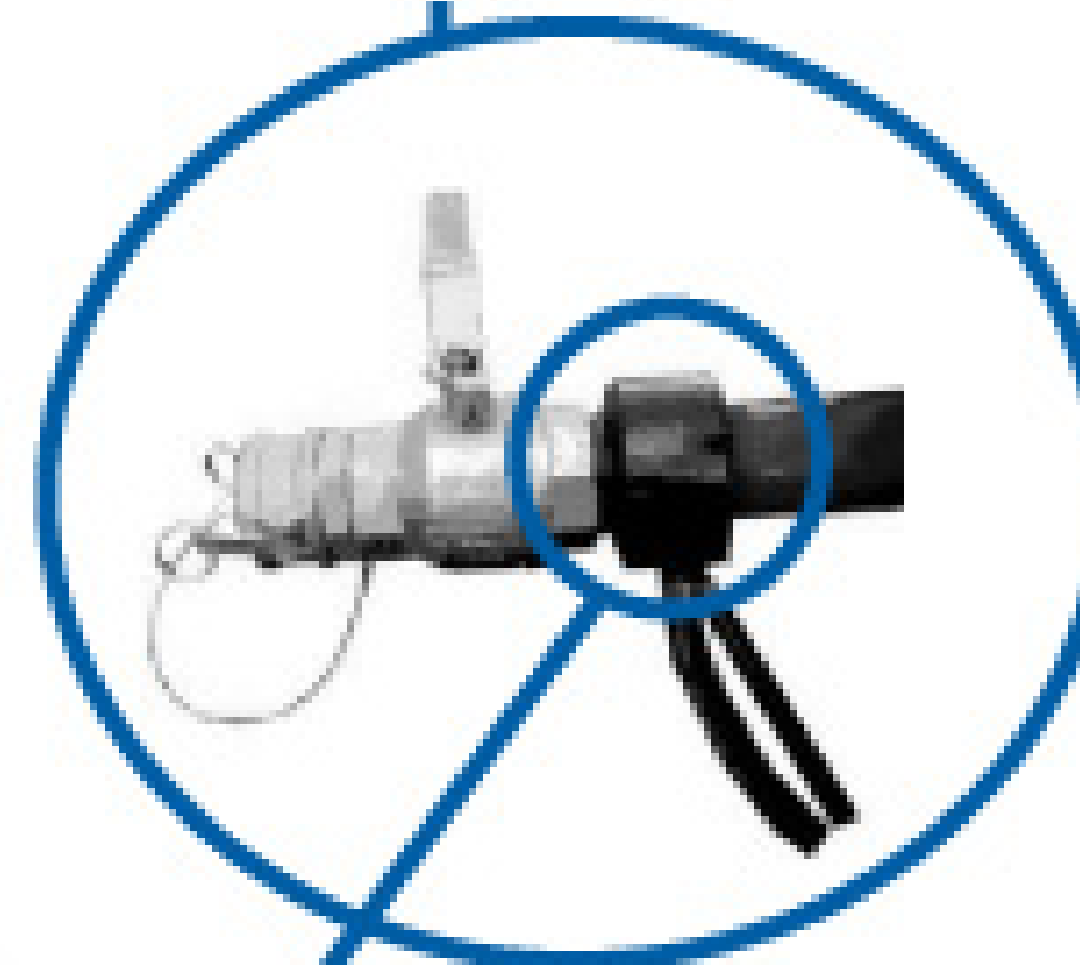

Add **Heated Collars** to your vacuum tank to help prevent the valves freezing. Many of our customers in the northern latitudes find that making a profit during the winter months is much easier with the installation of heated collars on their vacuum tank. The collars are both designed and built by Wee Engineer.

1 1/2 or 2 inch .. \$105.00	6 inch .....\$283.00
3 inch ..... \$157.00	Installation Kit (no hose) ...\$76.50
4 inch ..... \$189.00	110 V Heater Kit .....\$160.00

**Thank You!**



We appreciate Glenn Meyers of Meyers Septic Service for his continued business. We installed this 850 gallon aluminum 2-chamber tank, pump, flatbed, and lift gate on his 2008 Ford 550.

**Thank You!**



Thanks to Kim Halvorsen of AA Septic Service for purchasing this used unit, a 2001 Freightliner with a used 2500 gallon and NVE 360 pump system.



**P.O. Box 39 Dayton, IN 47941 Toll-Free: 877-296-2555 Phone: 765-296-2027 Fax: 765-296-3027**  
**www.wee-engineer.com**



# At the Car Wash

## An expansion-minded pumper wonders about the challenge of disposing waste from self-service car washes

*This feature in Pumper® reports noteworthy conversations that take place in the Pumper Online Discussion Forum for industry professionals found at [www.pumper.com](http://www.pumper.com). The forum is split into several topic areas: General Discussion, Business, Parts & Accessories, Portable Sanitation, Pumps & Blowers, Septic System Installation, Septic System Service & Maintenance and Trucks. Simply register with a user name and password and join the discussion!*

*Information and advice in Overheard Online is offered in good faith by industry professionals. However, readers should consult in depth with appropriate industry sources before applying such advice to a specific business situation.*

## Overheard Online

### Should I start pumping car wash pits?

#### Question:

Is anyone pumping car wash pits? I'm looking to add another service, but would like to know more. Specifically, tell me about disposal issues. Is car wash pit waste considered hazardous?

#### Answers:

It usually isn't considered hazardous, but it is considered contaminated. So you must be careful where you dispose of it. Also, carry paperwork showing what you're carrying on the truck. Check with your state to see where the waste must go. In some states, you can't easily switch from car wash pit waste to septic tank waste.



Car wash pits contain oil, grease and other products that cannot be dumped at sewer treatment plants. If you get caught, this could cost you many thousands of dollars in fines and court costs. I get offers all the time to do this type of work. I tell the car wash owners they cannot pay me enough to do this type of work. Someone in our area checked on disposal of this product and the cost was up to \$5 per gal-

lon. That is \$5,000 per 1,000 gallons before you charge for your time and hauling. I don't think I will be doing any of this work.



Here in Calgary, Alberta, Canada, car wash and garage sumps have to go to separate containers for disposal. For garage sumps, they charge \$85 per metric ton. If the car wash applies for a sanitary permit and if there is no oil in the waste, the price is half of that (\$42.50 per ton). That usually works out to \$200 to \$250 for disposal of a car wash with five bays. This car wash has only three sumps and gutters leading into the sumps. I usually get 750 Imperial gallons of waste from them. With driving time, (one hour each way) it usually takes me 3-4 hours to do the job.

The oil is not too hard to contain. You lay an oil absorbent cloth in the sump and all of the oil is soaked into the cloth. You then discard the cloth and clean the sumps.

You must have a way to remove the waste from the truck. The sand quickly separates from the water and settles to the bottom. I have a hoist and vibrator to deal with this, so it is not a problem. My first truck didn't, and it was a one-hour job to pry the residue off the bottom of the tank.

I guess your cost of disposal depends on your area. There has to be an accepted process because these things have to be cleaned on a regular basis. You have to bill your time plus the disposal cost. Do your homework, talk to the waste sites to find out how to deal with it. Figure how much time it takes to get to the disposal site. I charge travel time for both ways. If I am doing a car wash for the first time, I let the owner know that it is so much an hour plus disposal costs. I give an estimate for the hours and say if it is under that then I will charge less, but if it is over that then I will charge accordingly. Most of the time they are agreeable to this arrangement.



Here in Florida, car wash waste is considered hazardous waste and it cannot be hauled by a regular septic truck. A HAZMAT truck must be used. This is mainly because of mercury content in the wash water and sludge. Definitely check with regional laws.

I get offers all the time to do this type of work. I tell the car wash owners they cannot pay me enough to do this type of work.

### How do I get necessary experience in Florida?

#### Question:

I want to get into the pumping business in Florida, but to get a state license you need three years of experience. How do you get this?

#### Answers:

I hate to sound negative but you will need to go to work for an established company. There is more to the septic industry than just putting a hose in the tank and pumping it. If you want to learn you have to pay your dues. Good luck in three years if you still want to do it.



You need to pay your dues. Three years on someone else's coin and you will know if you can stomach it. I like the idea that Florida is demanding that much experience. Maybe you can find someone who is thinking about selling in a few years. Hopefully you can find a reputable company with good ethics. Here in Michigan, you have to have 30 hours of classroom credits approved by the DEQ (state Department of Environmental Quality) before you can apply for a license. And then you would still have a lot to learn. I worked with a septic firm after working my regular job and on weekends for five years before the owner decided to sell. I am now going on my seventh year and am still learning. Pull up your boots, put on your rubber gloves, and let's locate, dig up and clean some tanks.



I wish Maryland would start doing this to keep the fly-by-nighters out.



In Wisconsin, a program was implemented requiring 1,600 hours of training and passing a test. The DNR (Department of Natural Resources) also has the power to grant exceptions. ■



# ENGINE & ACCESSORY, INC.

Toll-Free: 1.800.327.5431

Tel: 305.573.2268

Fx: 305.576.4617

www.eamfg.com



Booth 5127A

Engine & Accessory is your one stop shop for all of your vacuum truck needs. Delivering the best possible customer experience.

### Benefits include:

- **ISP Program - In stock tank and truck program**
- **Direct access to all major chassis manufacturers**
- **State of the art manufacturing facility complete with service shop**
- **Extensive parts inventory and complete product support**
- **Full engineering capabilities using the latest technology**
- **Knowledgeable sales staff**
- **Customizable units with a broad range of options**
- **Nationwide product delivery**
- **Complete package of financing and lease options**



2007 Ford F750 - 2000 gallon tank (1500/500) - Low work station - Masport pump system - Several Available

Several Pre-Emission Units Available



2007 Isuzu NQR - 1250 gallon tank (900/350) - Low work station - Masport pump system - Several Available

Several Pre-Emission Units Available

**Many 2007 Pre-emission Fords and Isuzus available for Portable Restroom Service Units.**



Aluminum vacuum trucks. Sizes range from 2000-5500 gallons with many pumping system options available.

Call Today!



Spec your Industrial Unit. Options for Hoist and Full open rear doors. DOT Code and Non Code.

Call Today!



Steel vacuum trucks. Sizes range from 2000 - 4000 gallons with many pumping system options available.

Call Today!



Combination pumper designed for servicing portable restrooms as well as septic tanks.

Spec Yours Today!



# ON



## Personal Service From Our Team Of Experts

*With our new online services you can review balances, track your order and even place an order - anytime, anywhere.*



[www.satelliteindustries.com](http://www.satelliteindustries.com)

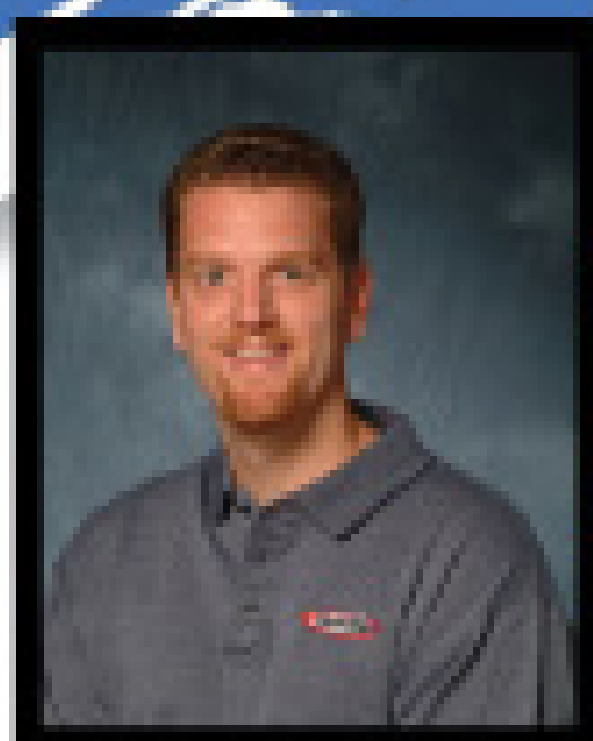

**John Sprenger**  
Northwest  
800-824-5755



**Dean Carstens**  
Minnesota  
800-328-3332

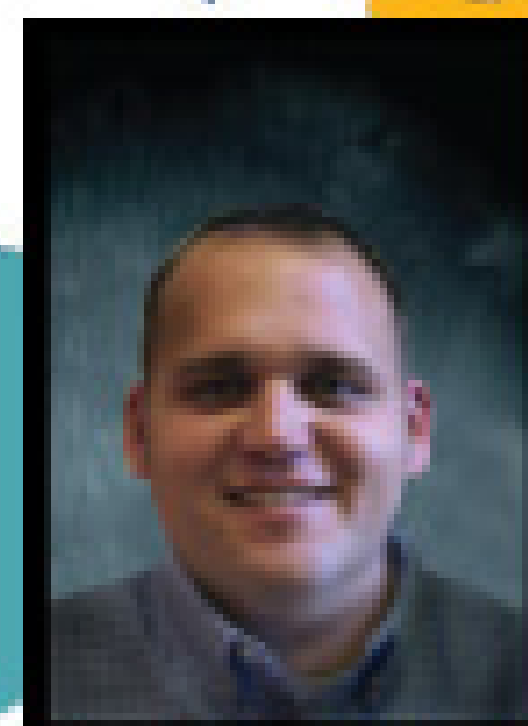

**Ryan Anthony**  
Great Lakes  
877-711-1054



**Pat West**  
Northeast  
800-328-2331



**Ron Sprenger**  
Southwest  
800-272-3280



**Gene Clay**  
South Central  
866-556-4630



**Henry McCall**  
Southeast  
800-548-4984



**Wes Tuttle**  
General Manager Truck Sales  
800-621-4469



**John Olson**  
Truck Product Sales Manager  
800-328-3332

# E-STOP

Having one vendor makes life easier



## All You Need To Operate Your Business Profitably

- ✓ Superior Restrooms
- ✓ Deodorizers With Rewards Program
- ✓ Full Line of Restroom & Septic Trucks
- ✓ Online Account Summaries & Ordering
- ✓ Full Line of Hand Wash Stations
- ✓ Unequaled Customer Support & Assistance

Call Today:  
**800-328-3332**

**Satellite**  
*Imagine The Possibilities*



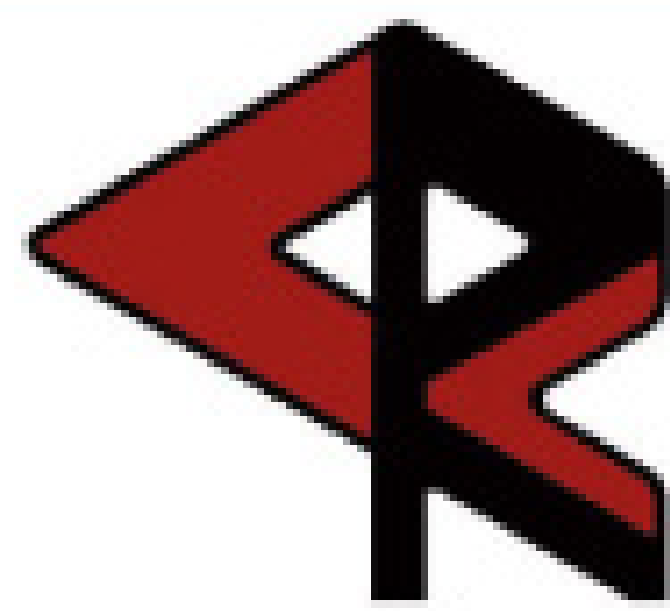

# CAPITAL RUBBER CORP

Innovative Pumping Solutions - Since 1975



## WEATHERFLEX ASSEMBLY SPECIALS

3" X 25 FT 2 FOR \$192  
 3" X 33 FT 2 FOR \$242  
 GREEN, GRAY OR BLACK HELIX AVAILABLE  
 SHIPPING ADDITIONAL

**FREE GIFT:**  
 RECEIVE A **FREE** PAIR OF THINSULATE®  
 LEATHER WORK GLOVES  
 WHILE SUPPLIES LAST

**(800) 258-3000**

## POWER BOOSTER PUMP SMART.



- INCREASES VERTICAL LIFT
- REDUCES PUMPING TIME
- REDUCES PUMP WEAR

★ SEE IT IN LOUISVILLE!



Booth 3093

[www.capitalrubbercorp.com](http://www.capitalrubbercorp.com)

		<p>1-800-333-9274 East * 1-800-786-9274 Custom                  1-800-351-7283 HONDA Parts * 1-800-964-9274                  1-800-454-9274 Open Till 7:00pm West</p>				<p>* Apply For 30 Day Terms Account                  * Low Interest Lease Plan                  * 5 Offices To Serve You                  * Free Lifetime Tech Support</p>			
<p><b>SWIVELS</b></p> <p>Mosaic &amp; Super Swivels  <b>\$22.10 &amp; Up</b></p>	<p><b>BYPASS VALVES</b></p> <p>From 500-7000PSI                  120 Models In Stock  <b>\$19.99 &amp; Up</b></p>	<p><b>TRIGGER GUNS</b></p> <p>Extreme Duty From  <b>\$7.99 &amp; Up</b></p>	<p><b>HOSE REELS</b></p> <p>200' Manual Reel  <b>\$79.99</b></p>	<p><b>Portable Hose Reels</b></p> <p>250' <b>\$299</b>                  350' <b>\$349</b></p>	<p><b>HOSES</b></p> <p>Up To 5800PSI 316Deg F. Rated                  Up To 200'  <b>\$29.99 &amp; Up</b></p>	<p><b>TURBO NOZZLES</b></p> <p>Up To 5800PSI Best Seller 4500PSI                  Only <b>\$39.99</b></p>	<p><b>PRESSURE GAUGES</b></p> <p>Stainless Steel Industrial Quality                  Up to 6000PSI                  Only <b>\$5.99</b></p>	<p><b>BALL VALVES</b></p> <p>Ball Valves Brass, Steel &amp; Stainless Steel                  New 6000PSI Stainless From  <b>\$23.99</b></p>	
<p><b>Honda Engines</b></p> <p>* 5Hp GC <b>\$199</b>                  * 6.5Hp GX <b>\$349</b>                  * 8Hp GX <b>\$459</b>                  * 9Hp GX <b>\$489</b>                  * 13Hp GX <b>\$589</b></p>	<p><b>Honda Twins</b></p> <p>* 18Hp GX610K1 <b>\$1,099</b>                  * 20Hp GX620K1 <b>\$1,279</b>                  * 24Hp GX670T <b>\$1,599</b></p>	<p><b>Compact Electric Hand Carry</b></p> <p><b>\$649</b> EHC2015G                  2GPM @ 1500PSI</p>	<p><b>Compact Honda Hand Carry</b></p> <p>Includes Pulse Valve  <b>\$799</b> HJ3028HC                  3GPM @ 2800PSI</p>	<p><b>Hose Reels All Types Available</b></p> <p>200' Portable As Shown <b>\$165.98</b></p>	<p><b>LT Replacement Engines</b></p> <p>Recoil &amp; Electric Start Available</p>	<p><b>CAT Pump Volume Distributor</b></p> <p>Complete Pumps Plumbed From <b>\$179</b></p>			
<p><b>Customized Electrics</b></p> <p>Auto Stop/Start Hose Reels, Etc</p>	<p><b>BEST Sellers ALWAYS on Sale</b></p> <p>5.8GPM @ 4000PSI <b>\$399</b>                  8.0GPM @ 3500PSI <b>\$499</b>                  7.0GPM @ 5000PSI <b>\$599</b></p> <p>Call For Free Quotation. We Also Stock Pumps With Left Hand Drive, Tapered Shaft, Car Wash Duty, 316 Stainless Steel and Unique Applications  <b>1-800-964-9274</b></p>	<p><b>High Performance AR Pumps</b></p> <p>13GPM @ 1450PSI <b>\$579</b>                  11GPM @ 3000PSI <b>\$629</b>                  5.8GPM @ 7250PSI <b>\$1,099</b>                  10GPM @ 7250PSI <b>\$2,899</b>                  44GPM @ 1500PSI <b>\$4,199</b></p> <p>We Stock 1000's of Pumps For Same Day Shipping!</p>	<p><b>New On Board Hose Reel Option</b></p> <p>50' x 100' Available On Some Models</p>	<p><b>Hose Reels Up To 350' Capacity</b></p> <p>Jetter Packages Available All Sizes</p>	<p><b>Replacement Pumps</b></p> <p><b>1-800-454-9274</b></p> <p>Up To 41GPM Up To 7250PSI</p>	<p><b>Replacement Coil Specialists</b></p> <p>For Hot Water Pressure Washers</p>			
<p><b>Truck or Trailer Mount</b></p> <p>Skid Mount &amp; Tank Feed Options Available On Some Models</p>	<p><b>Hydraulic Drive Pressure Washers</b></p> <p>3.0GPM @ 2000PSI <b>\$539</b>                  4.0GPM @ 2200PSI <b>\$649</b>                  4.0GPM @ 3000PSI <b>\$689</b></p> <p>Call For Details &amp; Hydraulic System Requirements  <b>1-800-454-9274</b></p>	<p><b>Cleaning Heads</b></p> <p>Full Line Of Cleaning Heads Available</p>	<p><b>Up To 8GPM Hot Boxes</b></p> <p>Adjustable Thermostats, Jumper Hoses &amp; Options Available</p> <p>L.P. Diesel Models Available</p>	<p><b>HONDA Best Seller</b></p> <p><b>\$2,999</b> 4000PSI Hot 4040HG-115</p>	<p><b>Frames &amp; Frame Parts Available</b></p> <p>Belt &amp; Direct Drive With Custom Options</p>	<p><b>Mobile Wash - Detailer System</b></p> <p>Self Contained On Board Water Supply</p>			

**Galbreath  
Toter  
Accurate  
CUSCO  
Parts Place  
Mountain Tarp  
Pioneer**

## **You wouldn't believe the names people call us**

**Wastequip** – the name to call for the best products and selection in the industry. People call us a lot of names. We don't mind. Just as long as they call. People who call Wastequip realize they have access to the best products and selection all under one roof. It is easier done than said. That is what makes us unique. Wastequip means streamlining your business and putting more money toward your bottom line. **With over 30 locations, each one can be your business supplier and your company resource.** So, here's another name you might want to call us– "Innovative."  
*Call us what you want — just as long as you call.*



**WASTEQUIP**  
*Nationally known for personal service*

**1.877.GOT.WASTE**



**CUSCO**

**Come Visit Wastequip in Louisville!  
Booth #4041**

**Louisville 2008**



MAKE YOUR MOVE





## DML2000

The best Magnetic Locator on the market

- Easily pinpoint buried septic tanks, water valves, water meters, survey pins, iron pipes ...
- All weather operation; -20° to 120° F
- Works great in rain, sleet or snow.
- Waterproof Sensors; base of electronics to the crutch tip.
- Comes with a Hard Plastic carrying case or a soft-padded case.
- USA Bluebook P/N: 64978
- Best warranty in the business, a **LIFETIME WARRANTY**

**Dunham & Morrow Inc.**  
 43676 Trade Center Pl., Suite 145  
 Dulles, VA 20166 703-661-2144  
[www.magneticlocator.com](http://www.magneticlocator.com)

# Agitation SAVES Aggravation!

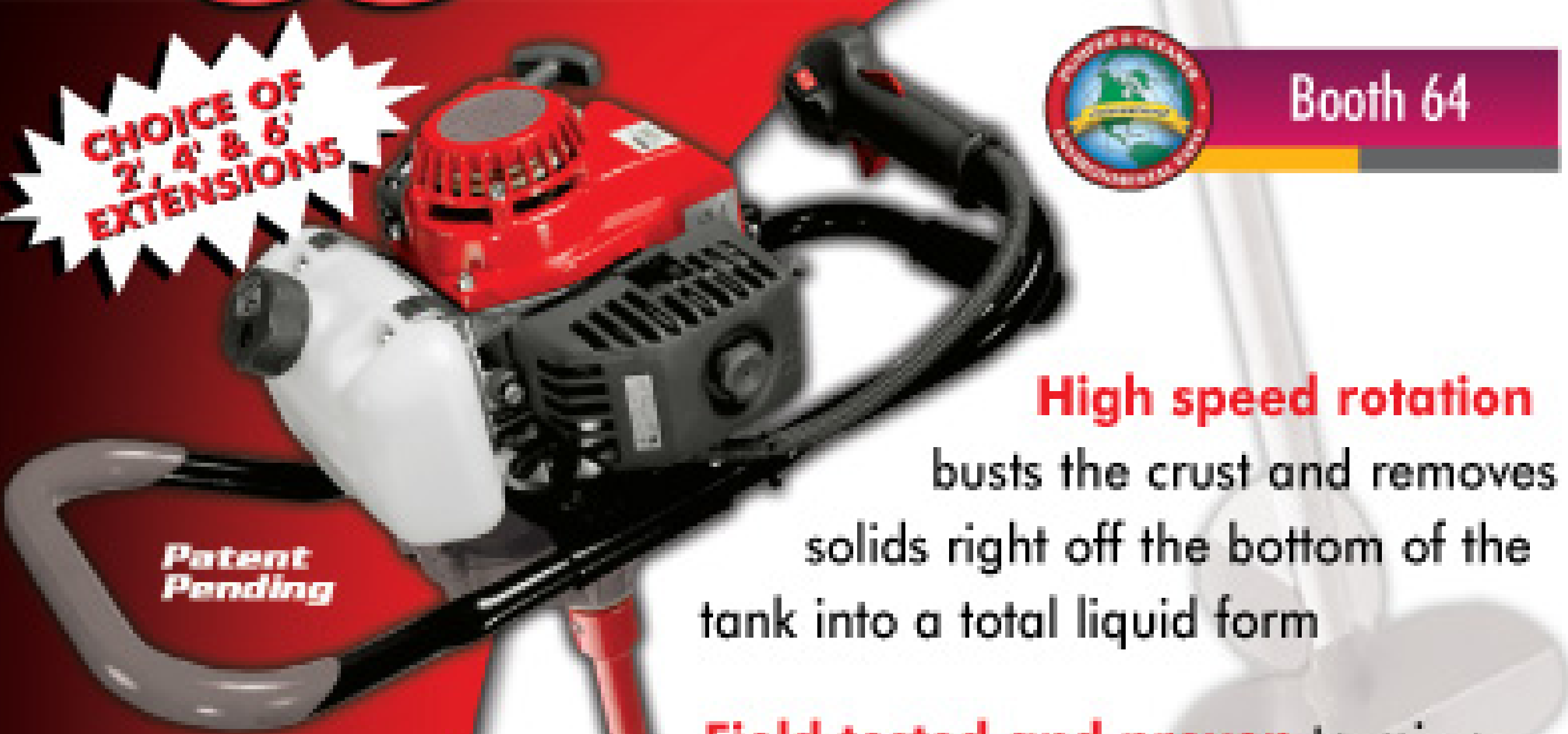

**High speed rotation** busts the crust and removes solids right off the bottom of the tank into a total liquid form

**Field tested and proven** to mix a residential tank in 5 minutes or less—takes approx. 15 minutes to agitate a 5000-10,000 gallon grease trap

CALL TODAY TO REQUEST A **FREE** INFORMATIONAL DVD!



**Guaranteed To Mix Up Septic Tanks & Grease Traps!**

## TESTIMONIALS

"Awesome piece of equipment! I don't know how I've worked without it. I've been cleaning grease traps and septic tanks for over 10 years and think the CrustBuster is the only tool I would not be without." — Troy Castens, Roto-Rooter

CHECK OUT OUR NEW INFORMATIONAL VIDEO AT:  
**PUMPER.COM/VIDEO.PHP**



ASK ABOUT OUR "BUSTER BRACKETS" FOR TRUCK MOUNTING



**Schmitz Brothers L.L.C.**  
 PHONE 763.878.2296  
 FAX 763.878.2299

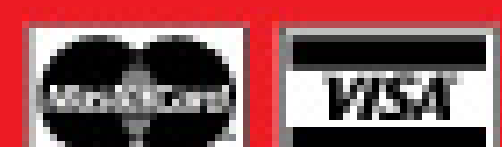

E-MAIL [pete@crustbusters.com](mailto:pete@crustbusters.com)  
 WEB SITE [www.crustbusters.com](http://www.crustbusters.com)

# 1.888.878.2296

## ART'S TRUCKS & EQUIPMENT

View Our Entire Inventory  
 Online: [www.artstrucks.com](http://www.artstrucks.com)  
 3001 West Expressway 83  
 McAllen, Texas 78503  
 956.686.2326 Fax 956.686.5179  
**1.800.292.7007**  
[www.artstrucks.com](http://www.artstrucks.com)



**1997 INTERNATIONAL 4700 Sewer Truck** DT444E Diesel Engine, Allison 653 Automatic Transmission, Air Brakes, Air Conditioning, Aquatec SJ1500, 91,819 Miles, Lot #2614742 - \$19,500

**1999 DODGE RAM 3500 Vacuum Truck** 5.9L Cummins Diesel Engine, Automatic Transmission, 4X4, 1000 Gallon Vac. Tank, 95,403 Miles, Lot #2715142 - \$17,500



**2001 FORD F750 Vacuum Truck** CUMMINS 5.9L Diesel Engine, 6 Speed Transmission, Air Condition, Air Brakes, 1000 Gallon Tank, 163,052 Miles, Lot #2715154 - \$19,500



**1997 INTERNATIONAL 4700 Vacuum Truck** INTL-175HP Diesel Engine, 5 Speed Transmission, Hydraulic Brakes 1200 Gallon Tank, Lot #2715246 - \$19,500





# **T** **RANSWAY** *SYSTEMS INC.* **PROFESSIONAL VACUUM EQUIPMENT**

**Toll-Free: 800-263-4508**

DELIVERY SERVICE  
AVAILABLE

**T: 905-578-1000**

**F: 905-561-9176**

314 Lake Ave. North  
Hamilton, Ontario L8E 3A2

**WE PAY BORDER CROSSING CHARGES • LEASING? WE CAN REFER YOU TO THE SPECIALISTS • OVER 40 YEARS IN BUSINESS**

## **HEAVY-DUTY EQUIPMENT THAT WORKS!**

**LET 45 YEARS  
OF EXPERIENCE  
WORK FOR YOU !**



Booths 4198-4199



**MUNICIPAL &  
INDUSTRIAL  
TRUCKS**



**SEPTIC  
TRUCKS**



**TOILET  
TRUCKS**



**ALUMINUM  
TANK TRUCKS**





# Life of the Party

Portable restroom Halloween costume is a big hit on the streets of New York

It took New Jersey artist/construction worker Rick Syers and Halloween to prompt the New York paparazzi, numerous celebrities and national media to look at the portable restroom in a whole new way.

## The Lighter Side

By Jim Kneiszel

Syers, with help from portable sanitation contractor Johnny On The Spot of Old Bridge, N.J., landed in a full-page cover photo in the *New York Post* dressed up as a guy reading a newspaper in a portable restroom. Syers was interviewed on CNN, met daytime talk show host Dr. Phil, actress Sarah Jessica Parker, and won \$5,000 in costume contest prizes.

You can see Syers walking the streets of New York at [www.youtube.com](http://www.youtube.com). Type Syers' name in the search box and you'll find numerous videos.

The Halloween hoopla began a week earlier when Syers called Johnny On The Spot president Jesse Thompson and asked if he could use some of the company's restroom labels for a unique costume. Syers is a construction worker who was familiar with the JOTS restrooms, having used them regularly on jobsites, Thompson said.

"He's a construction worker who's a fan of ours. We didn't know him," said Thompson, who granted the unusual request, not realizing the costume would create such a stir. "I mailed him the stickers and never thought I would hear from him again. Boy was I wrong."

In the context of Halloween, it's good fun and we loved it, but 364 days a year, I would have cringed if I saw that.

Jesse Thompson

### TAKIN' IT TO THE STREET

The *New York Post* called Thompson on Halloween and wondered if he sent Syers out with the costume to generate business, explaining that thousands of people were taking photos of him on street corners in Manhattan. Thompson later found out about the CNN interview, *Good Morning America* coverage and Syers' brushes with celebrities who emerged from television studios to take photos of him. Later in the day, Syers won costume con-



Artist/construction worker Rick Syers (left, with an admirer) won \$5,000 in prizes for his Halloween costume. Syers asked New Jersey company Johnny On The Spot for restroom labels to lend authenticity to his design. Above, an exterior shot shows how Syers obscures his legs with a dummy that appears to be carrying the unit. (Photos courtesy of Johnny On The Spot).

tests at Manhattan nightclubs.

"We had a lot of buzz here; the phone was really frying that day," Thompson said. For all of the publicity, the stunt didn't generate any immediate business for the restroom provider, and Thompson is reluctant to let the joke go any further. Thompson said it was all right to have a little fun at the expense of the industry, but wouldn't hear of the potty humor under any other circumstances.

"In the context of Halloween, it's good fun and we loved it, but 364 days a year, I would have cringed if I saw that," Thompson said. "We never go the humor

route. We don't say we're No. 1 in the No. 2 business or anything like that. We don't take a tacky approach."

Thompson said Syers would like to continue to use the costume for other purposes, but he will ask the artist to remove the restroom service company's stickers and paint the fake restroom so it no longer resembles their trademark green and tan Satellite Industries Tufway units.

Johnny On The Spot was started in 1969 when septic pumping company Central Jersey Septic expanded into portable restrooms. The two companies employ 125 people and serve New Jersey and counties just beyond the state border. ■





# TUF-TITE®



Booth 1218

For Samples & Pricing  
Call: 800-382-7009

## Septic Tank Riser, Lid & Safety Pan™

**FREE FREIGHT ON FULL CARTONS!**

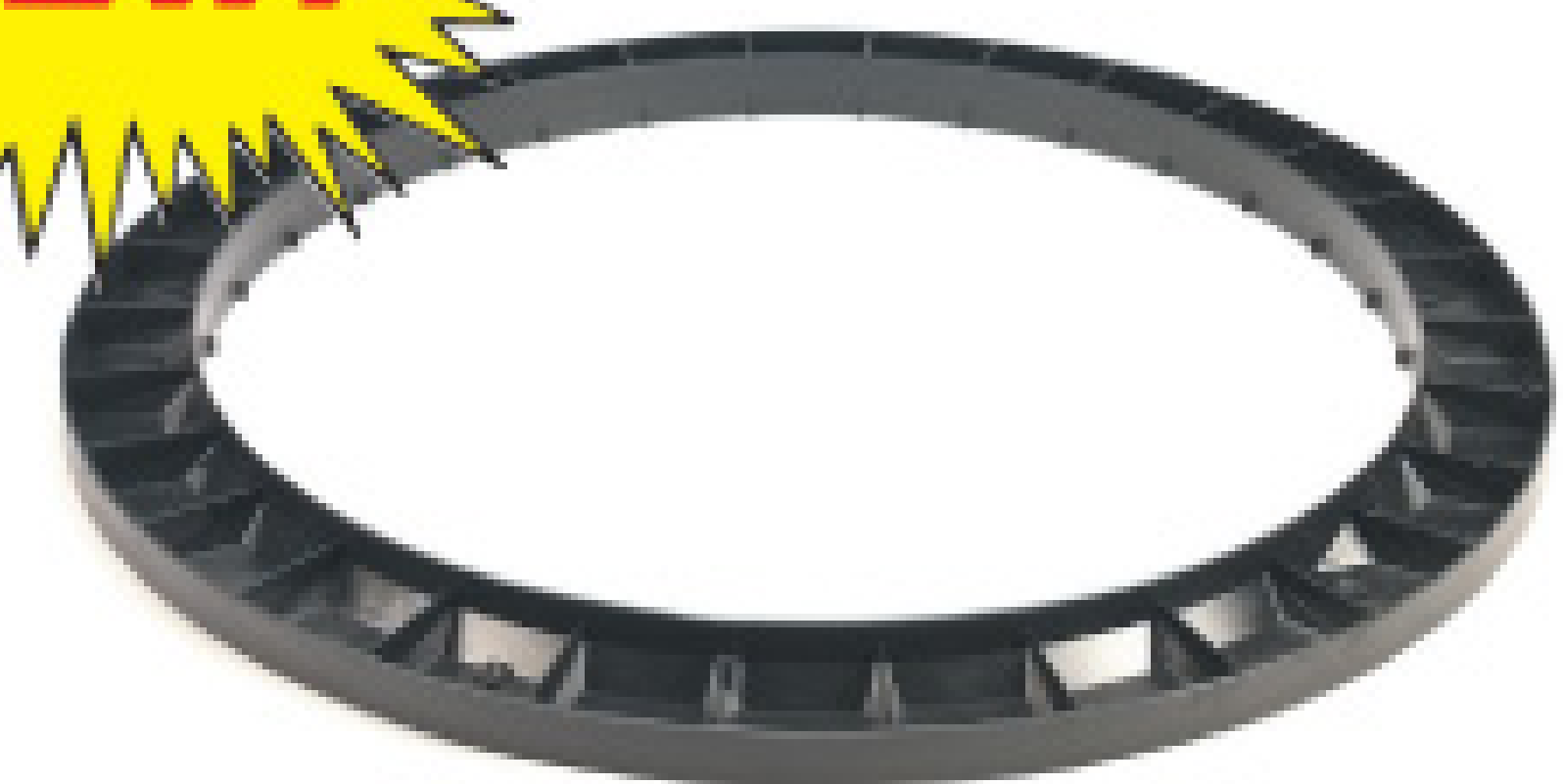

### Tank Adapter Ring

New - Horizontal Safety Screw.

Safety Pan™ to Riser attachment with 6 vertical stainless steel screws.

Riser to Riser attachment with 6 vertical stainless steel screws.

Patent Numbers  
5,617,679 &  
5,852,901; other  
pats. pending.

### Riser Lid

with Molded-in gasket.  
Available in 12", 16", 20" and 24" diameters.

Concrete Lid w/handle

### Safety Pan™

Safety Pan™ available in 16", 20" and 24" diameters.

### Riser

For septic tanks. Stackable in 6" increments. Available in 12", 16", 20" and 24" diameters.

### Tank Adapter Ring

For mounting riser flush to top of tank when casting-in is not an option.

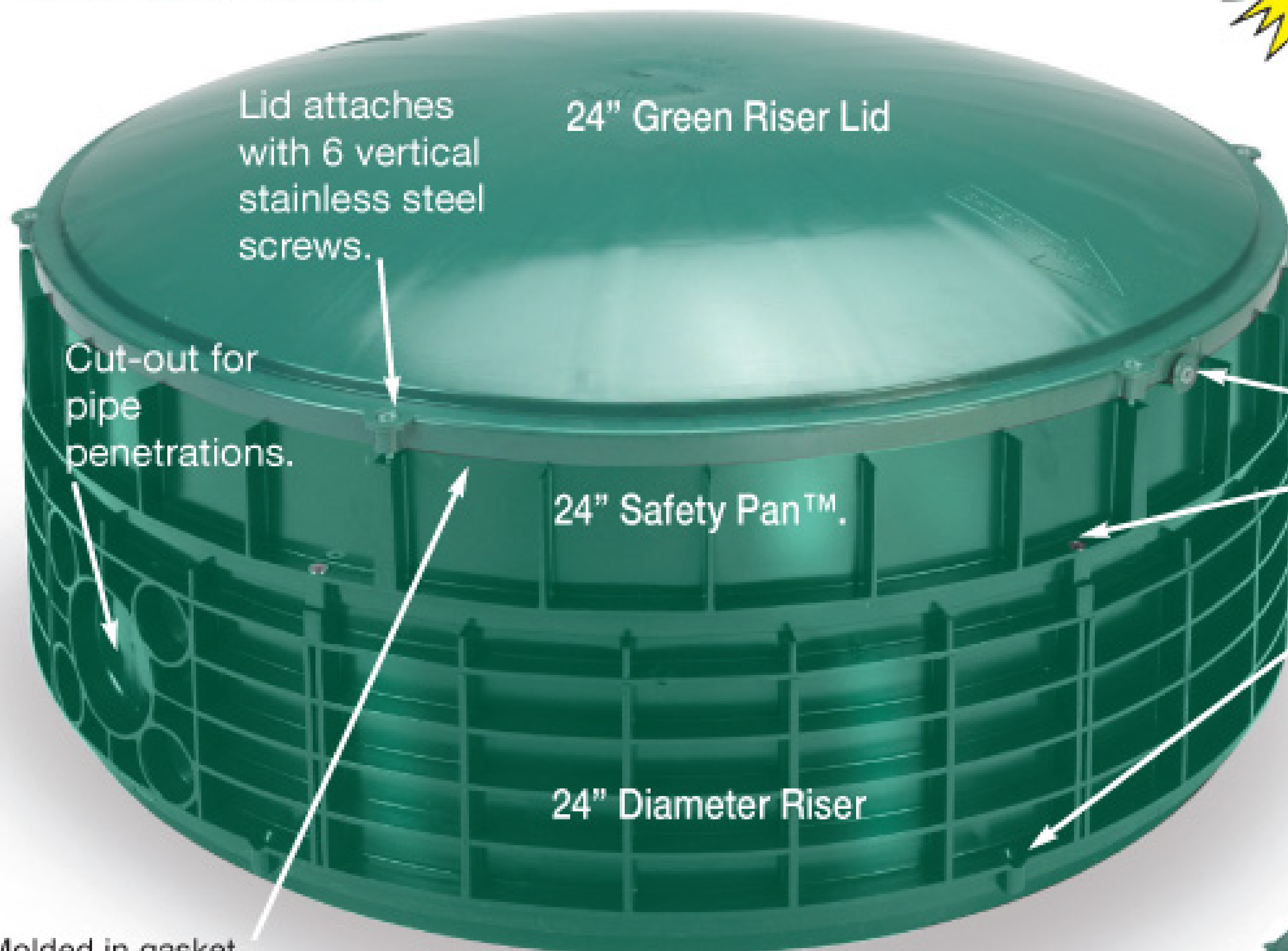

Molded in gasket.

Available in 12", 16", 20" and 24" diameters.

### Effluent Filters

Patent Numbers  
6,319,403; D 431,629; other  
pats. pending.

800 GPD  
ANSI/NSF  
Standard 46

4" Sch. 40 &  
SDR-35

**EF-4**  
4" Filter

**EF-6**  
6" Filter

1500 GPD  
ANSI/NSF  
Standard 46

4" Sch. 40 &  
SDR-35

244 ft. of  
1/16" filtration  
area.

Gas/Solids  
Deflector

### One-Piece Tank Seal

For concrete Septic tanks and D-boxes.  
Accepts pipes from 1-1/2" to 4".  
Mounts with or without concrete flash.



**TS-4-RUBBER TANK SEAL**  
(will hold 10psi)  
**TS-4PRO TANK SEAL**  
(will hold 5" vacuum)

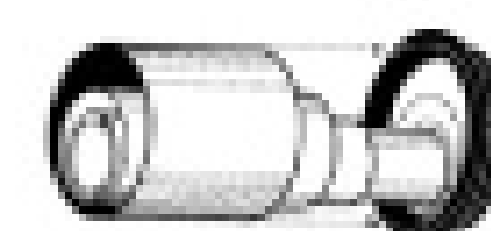

Free Freight: 32c

Patent No's  
4,951,914,  
5,624,123  
& 5,711,536;

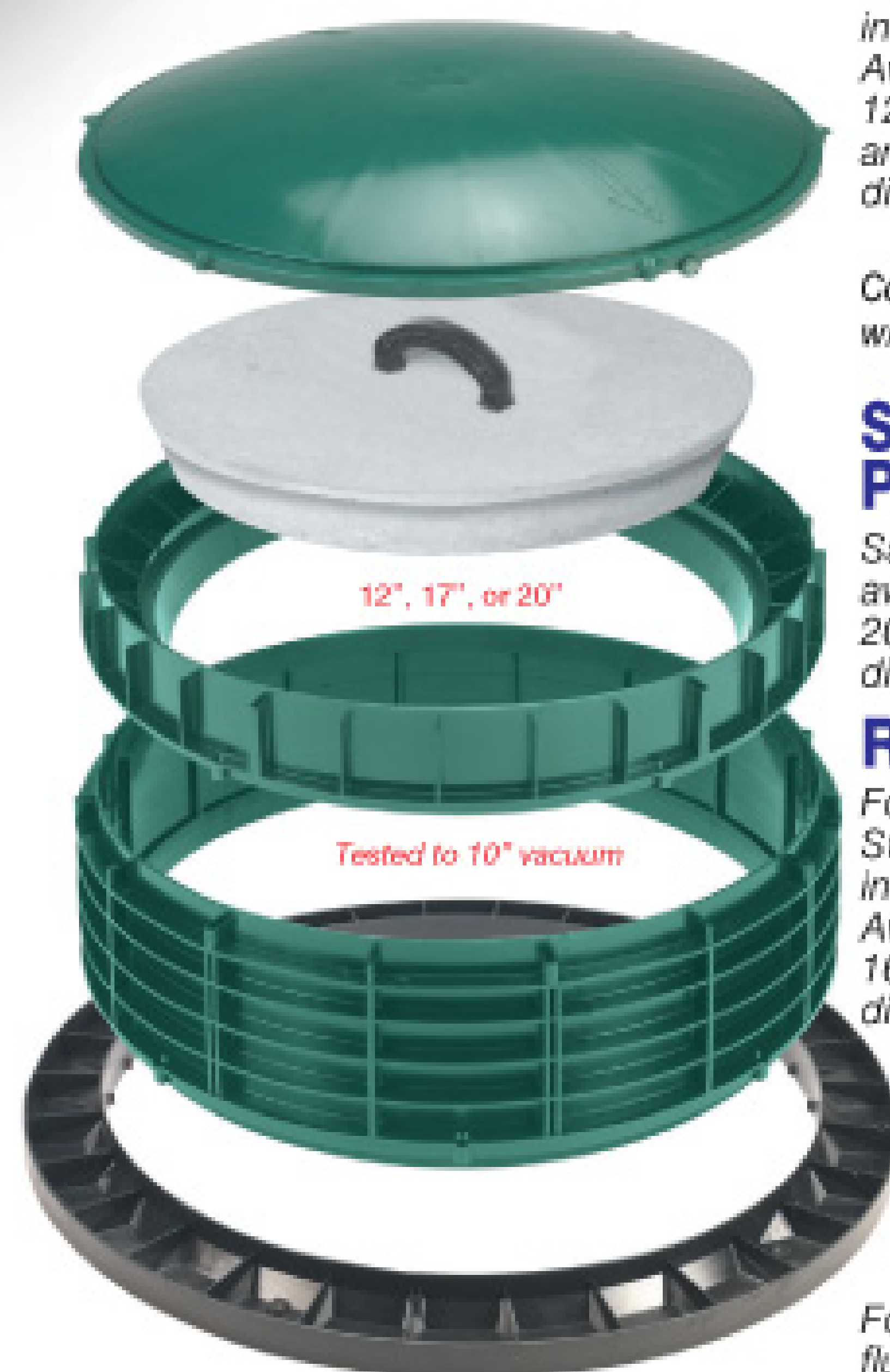

12", 17", or 20"

Tested to 10" vacuum

Tuf-Tite®, Inc. • 500 Capital Drive • Lake Zurich, IL 60047  
800-382-7009 • 847-550-1011 • (fax) 847-550-8004 • www.tuf-tite.com  
Plastic... Our Business, Not Our Hobby™





Working well under pressure!



# GET MORE JETTER FOR YOUR DOLLAR!



Booth 3069

**STB2511H-MAX**

**Full Featured Jets with Powered Reels:**

**SK4007V** 23 h.p. Briggs 7GPM @ 4000 PSI... \$9950

**STB2511H** 24 h.p. Honda 11 GPM @ 2500 PSI... \$11699

**SK3012K** 29 h.p. Fuel Injected Kawasaki 12 GPM @ 3000 PSI... \$13995

**STB2020V** 35 h.p. Briggs 20 GPM @ 2000 PSI ... \$19699

**STB4018DT** 19 h.p. Hatz Quiet Diesel 18 GPM @ 4000 PSI... \$39950

**Trailer Models starting at \$7499**

[www.camspray.com](http://www.camspray.com) **800-648-5011**

# RETIRING SPECIAL SALE

**STEVE REYNA**  
POB 457  
WEST MEMPHIS, AR 72303

[swreyna@msn.com](mailto:swreyna@msn.com)  
SEND EMAIL TO REQUEST PICTURES.

**870-636-2243**

Basic Portable Restrooms Event Quality .....	\$185 Each
Basic Portable Restrooms Construction Quality .....	\$175 Each
Basic Portable Restrooms With Sink .....	\$250 Each
Signature Series (Custom) Portable Restrooms .....	\$375 Each
Sinks .....	\$150 Each
Urinal Stations .....	\$400 Each
Holding Tanks .....	\$175 Each
Sewer Main Custom Portable Restrooms .....	\$400 Each
Children's Portable Restrooms ...	\$200 Each
Toters 40 ft. 22 Units (Price if Toilets Purchased) .....	\$2,800 Each
Toters 20 ft. 10 Units (Price if Toilets Purchased) .....	\$1,800 Each
Truck Ford L8000 1900 Waste/ 200 Fresh, 32,000 GVW .....	\$12,000 Firm
Truck Flat Bed/Pumper/Tommy Lift/ 500 Waste/150 Fresh .....	\$20,000 <sup>00</sup> Firm

Bonus if buy all equipment: All Supplies, Toilet Paper, Bag Soap, Doors, Sky Hooks, Chemical, Valves, Hoses, Parts and More..... FREE if You Purchase All Equipment.

Total Restrooms, Sinks, Urinal Stations, Holding Tanks, Sewer Main Units, Signature Units as listed above + 12 Barrels of Chemical as part of FREE bonus as stated above: 338 units Total as of 12/15/2007



**(800) 800-7575**  
(713) 675-7575 • Fax (713) 675-2500  
Houston, TX  
710 McCarty Drive • Charlie McDaniel

**See Our Inventory: [www.amigotruck.com](http://www.amigotruck.com)**

	<b>2005 MACK CX613 VISION</b> - E7 Mack 350 HP, 10 Speed, Camelback Suspension, 4.64 Ratio, 251" WB, All Steel Wheels, Tandem Axle, Double frame, NEW HydroVac, 3600 usg, D.O.T. 407/412, Hibon 820 blower 1400 cfm, hoist, full rear opening door, hydraulic vibrator, safety walkway, excellent truck. <b>Call for Price</b>
	<b>2007 FREIGHTLINER BUSINESS CLASS M2</b> - 106 MBE 600 Mercedes 300 HP, 9 Speed, Air Ride Suspension, 3.58 Ratio, 232" WB, All Steel Wheels, Tandem Axle, New Cusco 70 barrel D.O.T. certified vacuum, full opening rear door, hydraulic dump, Moro PM100 460 cfm pump, vibrator, double frame, excellent truck. <b>Call for Price</b>
	<b>USED 2001 MACK CH613</b> - Tandem Rear Axles, E7 Mack, 300 HP, 4.64 Ratio, Air Ride Suspension, 9 Speed; 275" WB, All Aluminum Wheels, Double frame, 44K rear, 14K front, New Cusco commercial aluminum vacuum tank, 4000 gal. capacity, Moro PM100 air cooled vacuum/pressure pump, 460 CFM, Stock # 6261. <b>Call for Price</b>
	<b>2001 MACK CH613</b> - E7 Mack 300 HP, 9 Spd OD, Air Ride Suspension, 4.64 Ratio, 262" WB, Aluminum/Steel Wheels, Tandem Axle, Double frame, New Cusco Aluminum Dump Commercial Vacuum, 4000usg, rear lifting door, MORO PM100 air cooled pump, 460CFM rating. <b>Call for Price</b>

**"Heavy Duty Headquarters"**



Booth 6167

# Seal it Tight! Seal it Easy! Seal it Fast!



- Easy 10 minute installation!
- Secure fit for all systems!
- Made & sold by septic installers!
- Prevent ground water infiltration and save money at the same time!



1  
Apply foam inside to tank.



2  
Place ring over opening and apply foam.



3  
Place plastic maintenance pipe on ring.



4  
Install lid.

**Are you tired of using risers that are too tall or too short for the job you are completing?**  
Plastic riser pipe will give an exact height each time. Try our system and you will never have to carry concrete pipe and lids again. Save time by not having to assemble multiple sections.

**Seal-It® Lids** Available in 12", 15", 18", 24", 30", 36".  
**Seal-It® Rings** Available in 18", 24", 30".  
**Inner Safety Lids** Available in 18", 24".

Seal-It® Lids can be personalized! Seal-It® Lids are manufactured with UV stabilizer to resist degradation from exposure to sunlight.

**For more information, call us today!**  
**BrenLin Company, Inc**  
Manufacturers of Seal-It® Products  
Herman, MN  
**888-606-1998**  
Fax 320-677-3001 • Email: [brenlin@brenlinet.net](mailto:brenlin@brenlinet.net)

# GapVax®



See us in Louisville!  
Booth #1022 at the Pumper Expo



888-442-7829

[www.gapvax.com](http://www.gapvax.com)

Industrial Vacuum Trucks    Combination JetVac Trucks  
Hydro-Excavators    Specialty Units    Cyclone Trailers  
Skid Units    Autoloaders



Patented Technology for Pumping

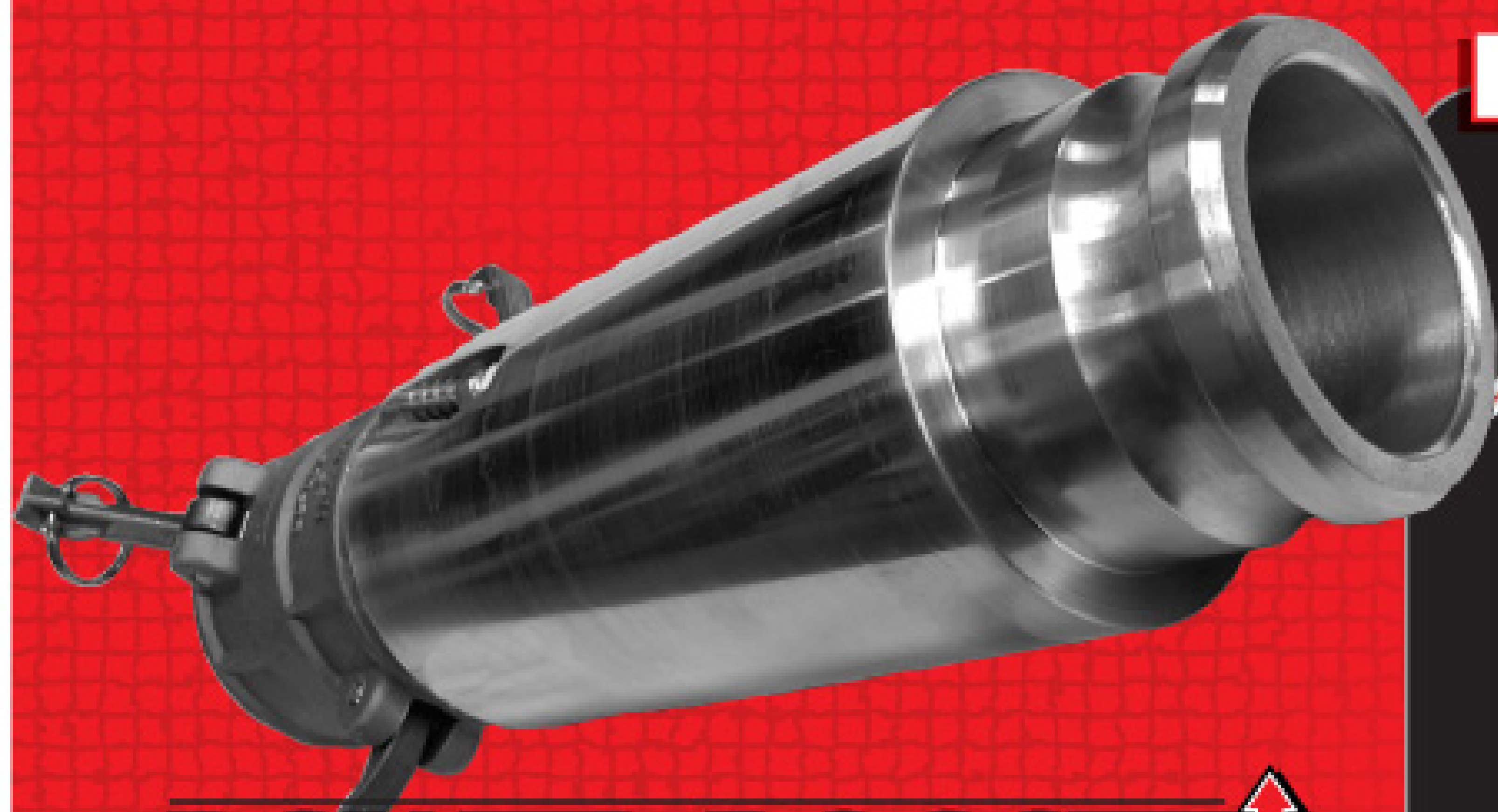

# PL Pressure Lift Corp

## POWER BOOSTER

The Exclusive Show Source  
**CAPITAL RUBBER CORP**



Booth 3093

- REDUCE PUMPING TIME
- INCREASE VERTICAL LIFT CAPABILITY
- INCREASE VACUUM PUMP PERFORMANCE
- DECREASE WEAR ON PUMP & EQUIPMENT

**CALL TODAY FOR A  
 FREE DEMO DVD**

Pump Deeper – Pump Quicker

**972.355.0550**

[www.pressurelift.com](http://www.pressurelift.com)

Stop by and see us  
 at the Louisville Show!



Booth 6097

## LIBERTY PUMPS



Omnivore LSG 200  
 Residential Grinder

We Carry a  
 Full Line of  
**LIBERTY  
 PUMPS**  
 which come  
 with a  
**2-year  
 warranty**



280-Series Mid-Range  
 Effluent Pump



**MEDO  
 Piston**

LA-60B \$275  
 LA-80B \$300  
 LA-100B \$445



**SECOH Diaphragm**

EL 60 \$255  
 EL 80 \$300

**0523**

Rotary Vane  
 Compressor  
 \$310



**Regenair**  
 R3105-12  
 Blower  
 \$410



**Sutorbilt & Roots  
 Blowers**

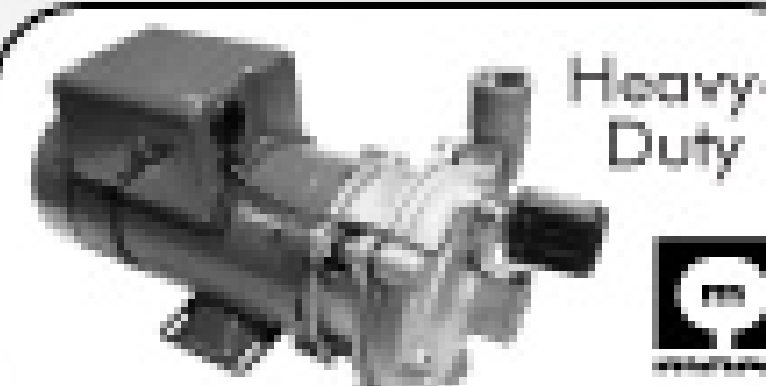

**DC-STAINLESS  
 Washdown Pump**



**Moro  
 M3  
 176 cfm**

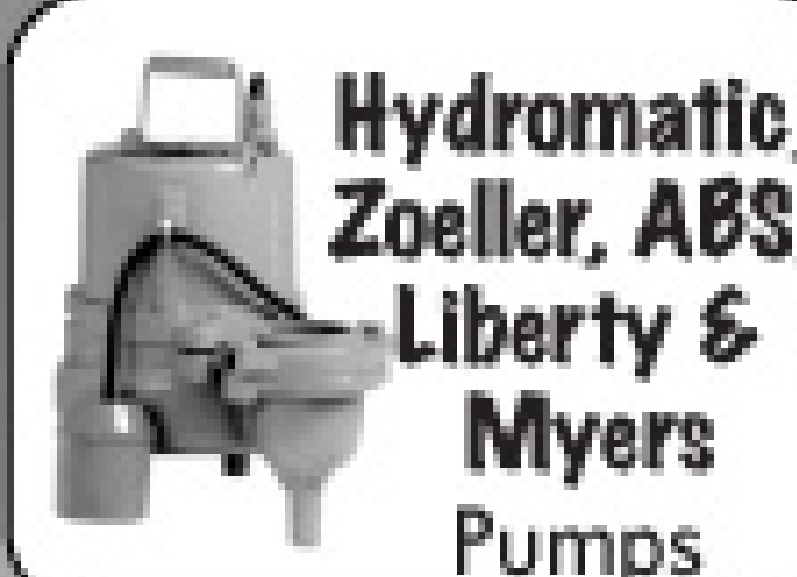

**Hydromatic,  
 Zoeller, ABS,  
 Liberty &  
 Myers  
 Pumps**



**SDS**  
 From 70-180 cfm

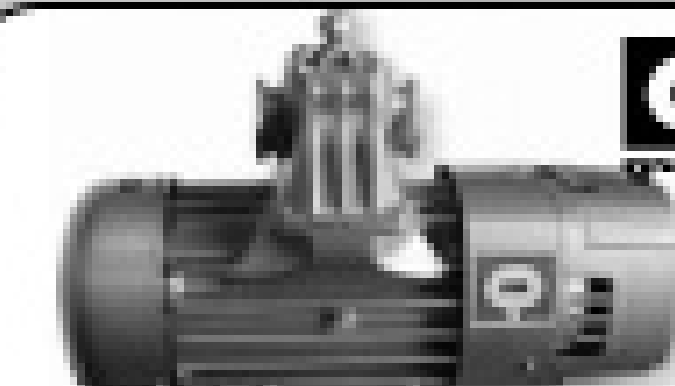

**Moro PM80  
 Turbo 350 cfm**



**Moro  
 M-10  
 230 cfm**

**Moro Pumps:** from 176 to 1642 cfm

### Flagg-Air Model 340

\$325

- 3450 rpm
- 1/4 hp, 115V
- Enclosed motor
- Stainless steel shaft
- High impact plastic parts
- Operates quietly
- 2-yr. warranty
- Fits in place of most original manufacturers' units
- Replacement parts available



The Flagg-Air 340 does not carry the NSF seal. Check local and state regulations for approval in your area.



**Septic Services, Inc.** toll free 1.800.536.5564 • 636.583.5564 • fax 636.583.6432  
 e-mail [septic@fidnet.com](mailto:septic@fidnet.com) • web [www.septicserv.com](http://www.septicserv.com)

# BEST ENTERPRISES, INC.

## Special Pricing on 07 Trucks - 800-288-2378

### 2007 Freightliner

While Supplies Last



1500 gal SS tank - 1,100 waste and 400 water. 190 cfm Conde SDS12 Vacuum Pump, Angle Drive system with clutch shift PTO, DC Burks Wash Down Pump with 50' Hose and Wand assy., 2" x 30' Tiger Tail Suction Hose, 1 1/2" Fresh Water Bucket Dump and 4" Waste Dump. 2- aluminum storage bin toolboxes, hose racks, and much more. **Blow out price: \$76,500.**

### 2007 Kenworth T300



1500 gal SS tank - 1,100 waste and 400 water. 190 cfm Conde SDS12 Vacuum Pump, Hydraulic Drive system with clutch shift PTO, Udor Pressure Washer with 50' Hose and Wand assy., 2" x 30' Tiger Tail Suction Hose, 1 1/2" Bucket Dump and 4" Waste Dump. 2- aluminum storage toolboxes, hose racks and much more. **Blow out price: \$78,500**

300/110 Slide In Unit

400/150 Slide In

400/200 Slide In

We Ship Over Seas

### 2007 International 4300 DT466

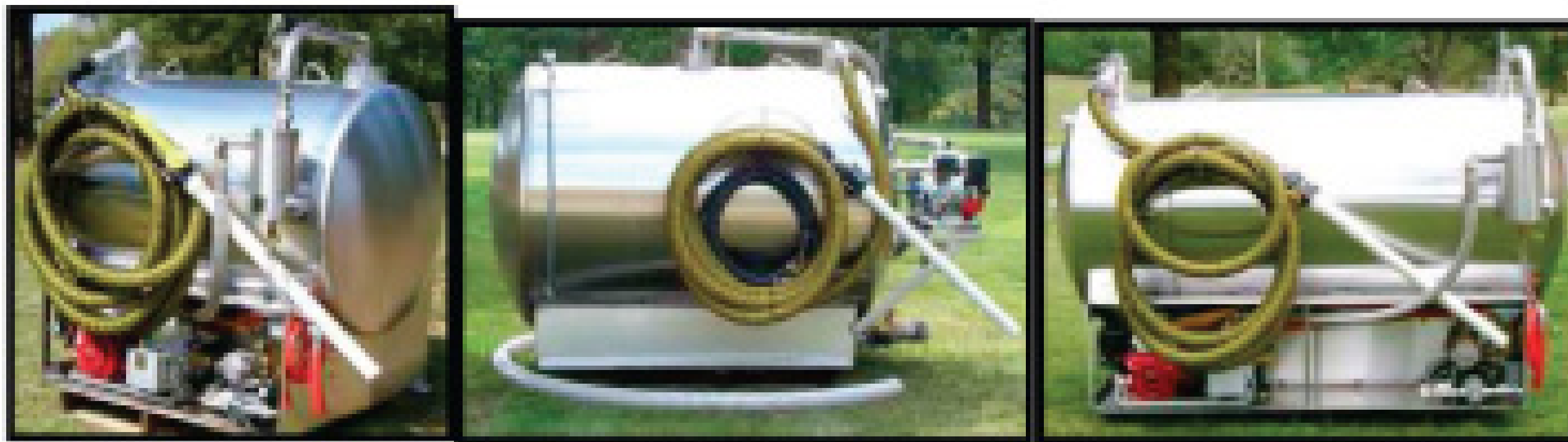

*It's all about the Stainless*

Visit us at the Pumper Show!  
Booths: 7208 & 7210  
Truck Spots: 7207 & 7211

1500 gal SS tank - 1,100 waste and 400 water. 190 cfm Conde SDS12 Vacuum Pump, Hydraulic Drive system with clutch shift PTO, Udor Pressure washer with 50' Hose and Wand assy., 2" x 30' Tiger Tail Suction Hose, 1 1/2" Fresh Water Bucket Dump and 4" Waste Dump, 2" Sight Glasses, sight tube, hose racks, toolboxes, and much more. **Blow out price: \$78,500.**



### 2007 Kenworth T300 with Aluminum



2000 gal Aluminum tank - 1,500 waste and 500 water. 230 cfm Masport HXL75V Vacuum Pump, Angle Drive system with clutch shift PTO, DC Burks Wash Down pump with 50' Hose and Wand assy., 2" x 30' Tiger Tail Suction Hose, 1 1/2" Fresh Water Bucket Dump and 4" Waste Dump, 5" Sight Glasses, hose rack, toolboxes, and much more. **Blow out price: \$78,000.**

Best Enterprises, Inc  
PH: (501) 988-1905  
1-800-288-2378

Cabot, AR 72023  
Fax: (501) 988-2880  
www.bestenterprises.net



# Tiger™

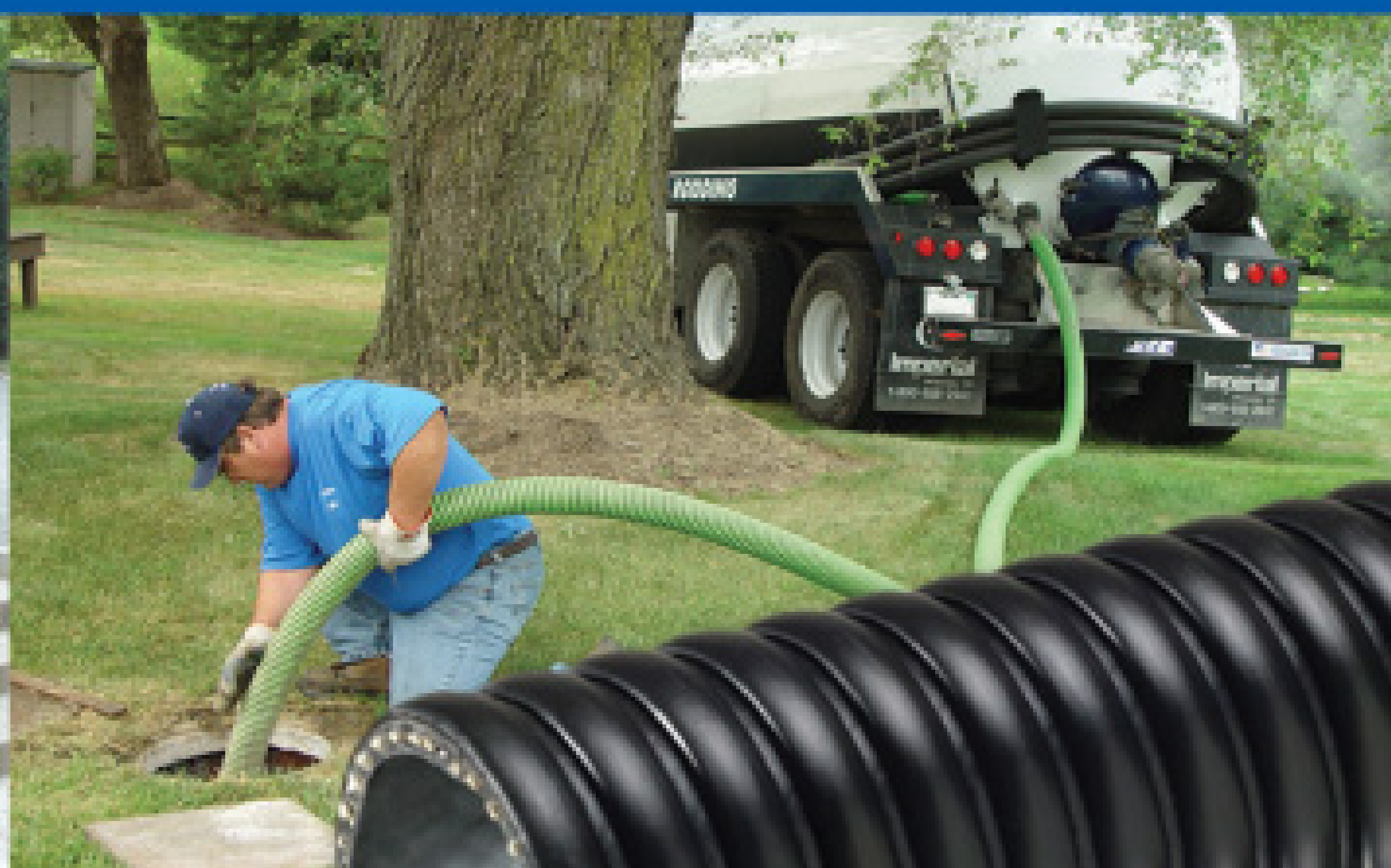

### Tiger™ Green/Tiger™ - SD

- Black flexible EPDM/polyethylene construction provides superior chemical resistance and superior durability
- Excellent cold weather flexibility
- Advanced helix design; provides optimum slide-ability, handling and durability
- UV and weather resistant exterior
- Lightweight design for ease of handling
- Synthetic yarn reinforcement (Tiger™ - SD) for suction and higher pressure discharge applications

### Applications:

- Septic handling
- Construction and mining
- Agriculture
- Water transfer



Nothing Else Is  
**TIGER™ GREEN**  
Ask For It By Name!



## Kuriyama of America, Inc.

360 E State Parkway | Schaumburg, IL 60173 | fax: 847.885.0996

847.755.0360 | email: sales@kuriyama.com | www.kuriyama.com



Booth 32



## Superior® 5E Electric Smoker\*

\*Smoke source - Superior® 1A; 2B smoke candles and SP smoke pellets

Find **LEAKS** and **SOURCES OF ODOR** quickly

- |                      |   |  |
|----------------------|---|--|
| <b>Handy</b>         | weighs 8 pounds<br>choose 110 volt or 12 volt                               |  |
| <b>Low Cost</b>      | \$100's less than competitive systems<br>1 <sup>st</sup> job can cover cost |  |
| <b>Simple to Use</b> | minutes to set up<br>seconds to see results                                 |  |

**Superior Signal Company, Inc.**  
800.945.TEST (8378) or 732.251.0800  
www.superiorsignal.com  
e-mail: info@superiorsignal.com

**435 GALLON VACUUM TANK**

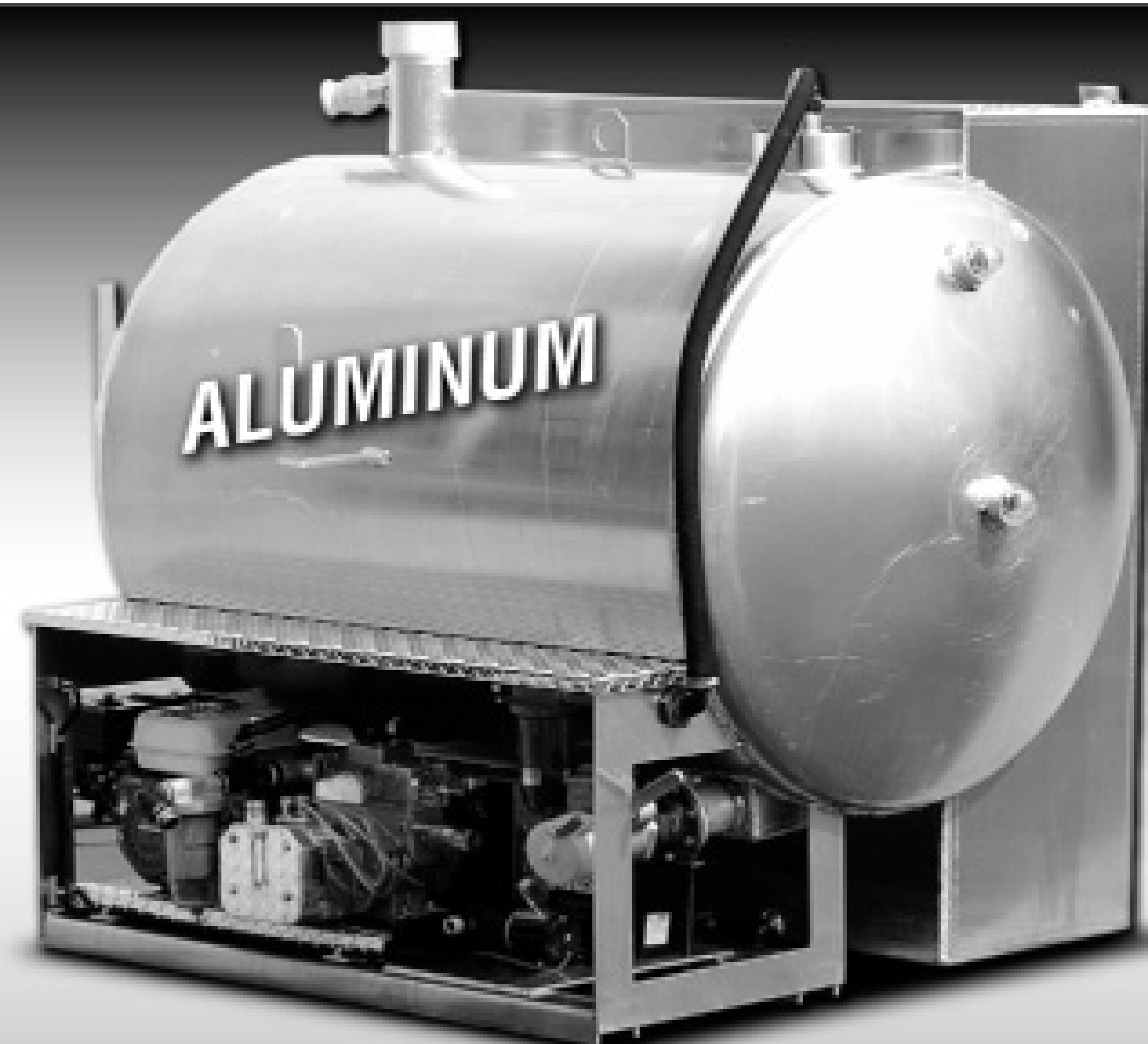

- 1/4" Aluminum Construction
- Conde Super 6 Pressure Vac Pump with 5.5 hp Honda Electric Start
- 12 Volt Water Pump
- 300 Waste/135 Fresh
- 25' Hose and Wand
- 2" Sight Eyes in Waste
- Sight Tube on Fresh Water
- Completely Self-Contained
- Ready to Work

**\*OTHER SIZES AVAILABLE\***

## Robinson Septic Service Inc.

125 Rockrimmon Dr., Bellefonte, PA 16823 • f: 814.353.0263 • email: honeydippers@aol.com

1.800.252.3848 • www.robinsonseptic.com





**"Built to do the work for you."**



**SOLD**  
 (1) - 2001 International 8100, ISM Cummins (280 HP), 76K miles, 10 spd. Trans., 76" dia., 3,150 gal., 5/16" Shell, Full Tilt/Open, 4" intake, 6" discharge, RCF Fruitland 500 pump

◆ (1) - 2008 Peterbilt 340 with a PX 8 330 HP and a 10 spd. Eaton-Fuller transmission, 76" dia., 3,150 gal., 5/16" Shell, Full Tilt/Open, 4" intake, 6" discharge, RCF Fruitland 500 pump



**SOLD**



**SOLD**  
 (1) - 2001 International 9100, N14 Cummins (370/450 hp), 70K miles, 10 spd. Trans., 76" dia., 3,150 gal., 1/4" Shell, Full Tilt/Open, 4" intake, 6" discharge, RCF Fruitland 500 pump

**Call Now To Order**

## ASME DOT 407/412 CODE UNITS

Mounted on a new or used Peterbilt, International or Freightliner

- ◆ (1) - 76" dia., 3,150 gal., 5/16" Shell, Full Tilt/Open, ready to be mounted\*
- ◆ (1) - 76" dia., 3,150 gal., 1/4" Shell, Full Tilt/Open, ready to be mounted\*
- ◆ (1) - 76" dia., 3,000 gal., 5/16" Shell, Full



Tilt/Open, ready to be mounted\*

- ◆ (2) - 72" dia., 3,150 gal., 1/4" Shell, Full Tilt/Open, ready to be mounted\*
- ◆ (2) - 76" dia., 3,000 gal., 1/4" Shell, Full Tilt/Open, ready to be mounted\*

**Call for quotes**

\* Tanks can be shipped.

## MANUFACTURER OF DOT 407/412 TANKS

For more information  
 contact L.C. Sutton



Global Vacuum Systems, Inc.

32804 US 290 West  
 Hockley, TX 77447

Toll Free: 800-843-0866

Email: [info@globalvacuumsystems.com](mailto:info@globalvacuumsystems.com)

Web: [www.globalvacuumsystems.com](http://www.globalvacuumsystems.com)



# Be It Resolved ...

10 ideas to increase your odds of achieving personal and financial success in 2008

By Erik Gunn

It's time for small business New Year's resolutions. Here are 10 to help you manage your money better.

**1 Read (or reread) two books on better managing money in your business and personal life.** Here are five suggestions:

- *The Only Investment Guide You'll Ever Need*, Andrew Tobias. An accessible, sensible, irreverent and no-frills guide to making and keeping more of the money you put aside to make more money.

- *Business Plans for Dummies*, Paul Tiffany and Stephen D. Peterson. Just what it sounds like, except you don't have to be a dummy to benefit from this straightforward, well-organized book.

- *Customers for Life*, Carl Sewell and Paul B. Brown. Subtitled *How to Turn That One Time Buyer Into A Lifelong Customer*, this book by a successful auto dealer teaches superior customer service.

- *The E-Myth Revisited*, Michael Gerber. The sequel/rewrite to Gerber's previous book, *The E-Myth*, preaches building business success by adopting the fundamental premises of successful franchises: clear and consistent procedures and operations.

- *The Business of Contracting*, Frank Blau (self-published). Don't let the photocopied printing fool you. This collection of columns by one of the plumbing industry's most admired innovators offers a wealth of useful advice.

**2 Review your expenses.** Where can you cut back, or even eliminate business costs? Don't just buy something because "it's deductible." Remember, you have to earn the money to pay for it first.

**3 Check your pricing.** Are you adequately covering overhead? Are you getting the margins you're capable of? Don't race competitors to the no-margin bottom. Charge what your work is worth and then make sure you deliver service worth what you're charging.

**4 Get bookkeeping software or upgrade the software you already have.** *QuickBooks* from Intuit is the most widely recommended in this category, and it offers a

good package adaptable to a wide range of businesses. But there are also some industry-specialized applications worth a look, some designed to work with *QuickBooks*, others in place of it.

Clear Computing of Tinton Falls, N.J., sells *Total Activity Control*, a package useful for septic, drain and sewer contractors. TAC adds to *QuickBooks* features needed to generate reports on operations, production, and sales and marketing, and it links back to *QuickBooks* to report gross sales or to recap customer or market types and to align both applications' data with bank statements.

Ritam Technologies of Eagle, Idaho, offers *Service Profit Builder*, which provides dispatching, job-tracking and accounting features. Ritam also has specialized packages for specific industries, including rendering and portable restroom rental.

GMF Associates of Johnstown, Pa., offers *Datsan Computer Software*, which provides applications for the septic industry and the portable restroom business. Both systems offer order entry, automatic billing, accounts receivable tracking and database query; the portable restroom product also includes routing and inventory control features.

**5 Hire a certified public accountant.** A saying has it that no business has failed because of its accountant fees — but many have failed because of poor accounting. A good accountant isn't just a bookkeeper — he or she can (and should) offer you sound, big-picture advice. Research candidates and interview more than one to make sure the person you hire really understands your business.

**6 Accept credit cards.** Plastic puts cash in your pocket faster, and for some customers it can make the difference between you or your competitor winning the sale. It's worth the initial cost of setting up a merchant account and the fraction of each sale that the credit card companies take.

A saying has it that no business has ever failed because of its accountant fees — but many have failed because of poor accounting. A good accountant isn't just a bookkeeper — he or she can (and should) offer you sound, big-picture advice.

Erik Gunn is a magazine writer and editor in Racine, Wis., where he operates Great Lakes Editorial Services, consulting for businesses, non-profits, and individuals. Readers may direct inquiries to him by contacting this publication at 800/257-7222 or e-mailing editor@pumper.com



**7 Review your insurance.** Do you have too little? Too much? When did you last bid out your insurance coverage? You may have earned a discount on your premiums by putting all your work with one insurer and by maintaining a good claims record over the year.

**8 Study your benefits.** Training and losing employees is a big money sink for some businesses. Offer workers things that can make a difference in whether they stay or go. Some are costly (health insurance), but better deals are out there. Other benefits — flexible scheduling, certain kinds of supplemental insurance, even a more attractive break room — can be fairly inexpensive.

**9 Set up a retirement plan.** This goes for employees and yourself. There are many ways to help your workers get started on retirement plans without spending a lot of extra money. And you should do the same for yourself. Retirement plans provide security for you and your family as you get older and free you from depending on the business. If you have a retirement plan already, fund it to the best of your ability.

**10 Consider offering service contracts.** Consider whether your business can accommodate some sort of prepaid maintenance or service plan. It can guarantee you business and provide a financial floor for your operation. Design one that's easy to maintain and helpful for your customers, and get sound professional advice in setting it up. Then make sure you promote it.

## GET TO WORK

The point of this list isn't to overwhelm you. Few if any of us could make 10 resolutions and follow them all through to success. Look at this list and find three, two, or even one item that looks particularly good. Then make it a priority and stick to it. And when 2009 rolls around, pick up this column again, and keep going. Happy New Year! ■

# Spare Parts Kit



Our spare parts kit comes complete with everything you'll need to repair your Hampel restrooms —

Nothing.

The most durable and affordable restrooms available.



Engineered for strength, durability and value.

[www.hampelcorp.com](http://www.hampelcorp.com) • 800-549-1558



Booth 4171



#5187 & 6187



Sludge Mate  
& Poly-Mate



DEWATERING MADE SIMPLE.

Flo Trend Systems Tel - 713-699-0152  
707 Lehman St. 800-762-9893  
Houston, TX 77018 Fax - 713-699-8054  
sales@fлотrend.com

The Flo Trend® Sludge Mate® and Poly-Mate® form an economical and simple to use sludge dewatering system. The Poly-Mate® conditions sludge through the addition of polymer prior to the dewatering process which occurs in the Sludge Mate®. These units are designed to dewater sludge from a multitude of waste stream sources including: water and wastewater treatment plants, septic tanks, car washes, industrial sumps and lagoons, grease traps, rendering plants, and food processing plants. The Sludge Mate® and Poly-Mate® are available in a variety of sizes and configurations, and are built to custom specifications.

Tanks  
made with  
attention  
to detail.



# Amthor is Innovation

Looking for a new tank? Think Amthor.  
At Amthor, we deserve our reputation for quality, innovation and expertise.

Our products meet the demands of today's consumer AND exceed industry expectations. With a nationwide distribution network, delivery is simplified. Plus, you'll enjoy exceptional customer service.

Visit us online for specific product information.



Amthor Matador



[www.AmthorInternational.com](http://www.AmthorInternational.com)

For your nearest distributor contact: Hank Vanderveen

VA Office: 434.656.6233 • Tel/Fax: 252.293.1284 • Cell: 845.494.0104

# FREE DELIVERY!



Booth 9003

On **ANY NEW** Vacuum Service Tank Truck\*  
To the Pumper Show, Louisville, KY  
February 28 - March 1



\*On **ANY AVAILABLE** New Chassis & New **progress tank**

Taking AIM at Ford 550 and the Chevrolet 5500

## NEW! 2008 Sterling Bullet

Cummins 6.7 Liter Turbo Diesel 305 HP / 6 Speed Automatic  
7,000 lb. Front Axle 13,500 lb. Rear Axle  
Exhaust Brake, AC, AM/FM-CD, Cruise,  
**1000 Gallon PORTAVAC**  
650 Waste / 350 Fresh / Masport HXL4  
Burks washdown / Hot Shift P.T.O.

### \$65,800

Lease from **\$1316.** mo  
4 Wheel Drive ... \$71,495



## NEW! Mid-Range 22,000 GVW Non-CDL

**2008 Kenworth T300**  
Cummins, Allison automatic,  
Hydraulic Brakes, A/C.

## 1700 Gallon PORTAVAC

Masport HXL 4, Burks Wash Down  
System, Workstation, Hot Shift PTO  
w/ Remote Controls, Unit Hauler.

### \$73,900

 from \$940.mo.

## NEW! 2007 Peterbilt 340

Cummins diesel, 10-Speed Trans.  
**3600 Gallon Aluminum**  
Masport HXL400 Water Cooled  
400 CFM Vacuum Pump  
Jetter System and Tool Box.

Full Opening  
Rear Door  
with Tank Hoist

### \$123,999

 Plus FET  
As Low As **\$1574.** mo.

# KeeVac

Industries Inc.

Call Kevin. Call Matt. ...Just Call KeeVac

# 866-789-9440

www.keevac.com



Kevin Keegan  
31 Years Experience

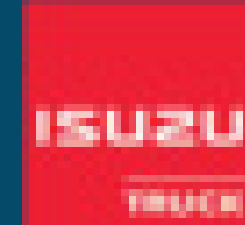

Matt Crowell  
17 Years Experience



# Great Trucks, Less Bucks!

Introducing  
**SPG  
TANKS** INC.

North Carolina's NEW Full Service  
Vacuum Tank Truck Dealer

Portable Restroom Units



Flat Vac Units for Portable Restrooms



Septic Units

- Aluminum, steel and stainless steel tanks
- Numerous bare tanks and chassis in stock.
- A full line of portable restroom, single-axle and tandem units, completely assembled in stock ready for immediate delivery.
- Full financing and leasing packages available.
- No external rings and 5/16" sideshell on aluminum tanks with full head baffles. The thickest aluminum tanks in the vacuum industry.

Call for  
info/prices/details

OFFICIAL DISTRIBUTOR  
**AMTHOR**  
International



#16022, 16026, 17025



ROY COFFEY  
President

**SPG  
TANKS** INC.

1804 Flint Hill Drive  
Hickory, NC 28602

(828) 312-9545

rcoffey2256@conninc.com

## MOBILE RESTROOM TRAILERS From The Experienced Professionals at WELLS CARGO COG



The **Comfort Elite Series** is the perfect solution for "on-site" portable restrooms and showers. Totally self-contained and environmentally friendly, the **Comfort Elite Series** is a welcome addition to any special event where demanding expectations are the norm. With the industry's shortest production lead times\* and unmatched experience, the professionals at **Wells Cargo COG** will work closely with you to find the perfect solution to your mobile sanitation needs.



ADA Units



Showers



Lead Referrals



Never Look Back  
Warranty Program

OVER FIFTY YEARS OF NEVER LOOKING BACK!  
1954 **WELLS** 53 2007 **CARGO**

Call: 888.574.4222

click: [www.wellscargocog.com](http://www.wellscargocog.com)



#4211, 4212, 4213, 4217, 4219

\*Standard units usually  
in stock & ready-to-ship!





48 YEARS OF DEPENDABILITY

# TUFF-JON



Booth 106

- One-Piece Construction
- Lightweight
- Rust-Free Hardware
- Wood and Poly Skids
- Large Variety of Colors



Tanks in 60, 105, 225, 300 and 440 Gallon Sizes



90 Gallon Free-Standing Sink



60 Gallon Rinse Tank

### — OPTIONAL ACCESSORIES —



7-1/2 Gallon Handwasher



Tuff Jon with Lifting Bracket Assembly



Urinal



Paper Dispenser



Sky Heater



Exceptionally Strong Tank Design

**The TSF Company Inc.** | 2930 S St. Phillips Rd. | Evansville, IN 47712

Toll Free: **1-800-843-9286** | **812-985-2630** | Fax: **812-985-3671**

E-mail: **tsftuffjon@sbcglobal.net** | Web Site: **www.tuff-jon.com**



PORTABLE TOILETS | CHEMICAL TOILETS | HOLDING TANKS | HAND WASH UNITS



# PRO-VAC

INDUSTRIAL PUMPOUT STATION

*There is no substitute for professional pumping equipment*

- Ideal for grease trap pumping
- Extremely maneuverable, can go just about anywhere
- Pumps fast, 60 GPM, 60 gal. capacity
- Will not blow 15 amp breakers
- Will not overflow
- Has odor control technology
- Comes complete with everything needed for pumping
- Factory direct with factory support

Call today for complete information and specifications on the industries' most complete portable pumpout unit.

**Toll Free 800-367-0972**

**Westmoor Ltd.**

P.O. Box 99  
Sherrill, New York 13461

**NOW 30% More Power!**



Booth 8109

On The Web At: [www.westmoorltd.com](http://www.westmoorltd.com), e-mail: [pumps@westmoorltd.com](mailto:pumps@westmoorltd.com)



Self Leveling Camera



PLUMBER'S MATE



Affordable  
Mainline System

MINI MAINLINE

See Further.  
See Clearer.  
See Everything.

ULTRA-MICRO BW

3/4" BW Camera



Booth 144



ROLLER SKIDS



512Hz-LOCATORS

**Ratech**

See Everything.

800.461.9200 905.660.7072 [www.ratech-electronics.com](http://www.ratech-electronics.com) [sales@ratech-electronics.com](mailto:sales@ratech-electronics.com)





**2003 MACK CX VISION**  
3600 gal US Tanks, LC 420 CFM Water Cooled Juroop

# SEE US AT THE LOUISVILLE SHOW



#6007-6009



**2001 MACK VISION**  
4500 gal US Tanks, Double Frame, Juroop 420 CFM



**2001 MACK**  
3600 gal US Tanks, 420 CFM Water Cooled Pump, All Aluminum Wheels, Custom Paint



**2001 STERLING**  
4000 gal US Tanks, Dump, Double Frame, LC 420 Juroop



**2003 MACK CXS**  
4000 gal US Tanks, Double Frame, Show Truck, Juroop LC 420 Water Cooled



**2003 FRTL FLC120**  
4000 gal US Tanks Double Frame, LC 420 CFM Liquid Cooled

**SEVERAL 2003 MACK CXs AVAILABLE**



**1999 MACK CH**  
3200 gal Used, Special Price \$42,000



**THANKS TO ROSE INGENIRING**



**THANKS TO MARTIN, INC.**



**1999 MACK CH**  
2200 gal, \$47,000



**THANKS TO BLUE LOOS**



**THANKS TO ISMAEL HERNANDEZ**

**ISRAEL VERA:**  
**305-525-6406**

## OUR 28<sup>TH</sup> YEAR NATIONAL TRUCK CENTER

Juroop or Masport liquid cooled pumps, original pump brackets and accessories, double frame on all trucks 4000 gallons or larger is standard

9750 N.W. 27th Ave. | Miami, FL 33147

Phone: 305.691.8407 | Fax: 305.691.8416

[www.nationaltruckcenter.com](http://www.nationaltruckcenter.com)

★ WE EXPORT OR DELIVER ★

**U.S. Tanks**  
THE TOP DOG OF VAGUUM TANKS



# 'I've Driven Four Trucks Home'

Attendees say the Pumper & Cleaner Expo feeds equipment needs and gives them a leg up on the competition back home

By Mary Shafer

It's a question professional pumpers ask themselves every year: Should I attend the Pumper & Cleaner Expo? The realities of everyday business can get in the way — Who will run the shop while I'm gone? Can I afford to take that much time off? Can I justify the expense of airfare and hotel?

For the pumpers interviewed here, it's a moot point. They say if you're serious about your business, Expo attendance isn't optional. You're here.

Find out why these dedicated contractors believe so strongly in reserving the time each spring to be part of the industry's biggest trade show.

"I don't know how you can be in the business and not be here," says Nate Gay. "Things are passing you by!

"Everything changes, and coming to the Expo keeps you current with the newest and the latest. My customers expect the latest technology to keep prices down through efficient operation and a high level of service. I rely on what I learn at the show to keep me profitable while fulfilling those expectations."

Gay tends to place serious equipment orders at the Expo. "I've driven four trucks home," he recalls. "I've had years when I spent \$150,000 on the show floor."

He feels confident leaving his shop in the hands of a competent office manager, who keeps orders moving and informs him about unusual developments via cell phone.

"One thing that works well for me is the show's schedule. I don't know that I could be here every year if they held it in July. I have a more seasonal business than most, and February is my deadest of the dead, so it's good for me to be here then."



**Name:**  
Nate Gay, owner  
**Company:**  
A1 Environmental Services  
**Location:**  
Wells, Maine  
**Employees:**  
9  
**Years in Business:** 11

## BONUS

### PIPELINES PLUS:

The Pumper & Cleaner Environmental Expo International can be an overwhelming experience. Attendees who want to get the most out of their time should plan a strategy that allows them to see all the exhibitors they came to see, while still enjoying the entertainment and all the other attractions the new location, Louisville, has to offer.

Trade show veterans recommend spending some time before the show with the exhibition floor plan, mapping out the most efficient route to cover all the displays you need to see. One strategy is to prioritize your visits, covering all the "must-sees" in your first circuit, then returning to those you'd really like to see once the important business has been covered, while allowing some extra time to go back to those surprises you encountered along the way but weren't sure you'd have time to explore.

Visit [www.pumpershow.com](http://www.pumpershow.com) for all the planning information you might need.

Comments may be directed to Mary Shafer in care of Pumper. You may also e-mail [pipelines@pumper.com](mailto:pipelines@pumper.com).



**"You're losing a lot of money by not coming to the Expo. You need to keep moving with your competitors, and if you're not here, they probably are."**

Bryce Harding

Anthony Foster makes a regular annual trek to the Expo, and can't understand why his competitors don't. "You don't come? Good! Stay there, so I can learn more than you," he says, laughing. "I like when they stay home, so I can be the best in my area."



**Name:**  
Anthony Foster, owner  
**Company:**  
Bermuda Sanitation Engineering  
**Location:**  
Crawl Hamilton Parsih, Bermuda  
**Employees:** 8  
**Years in Business:** 18

Foster finds building vendor relationships the most important aspect of show attendance. He regularly spends about \$20,000 on new trucks and large equipment. Sometimes his wife accompanies him, other times she stays home to run the shop while he's away.

He enjoys the cross-pollination of ideas he experiences with other pumpers at the show, along with being exposed to the industry's cutting-edge technology. "It's stimulating," he says, adding that he takes that excitement back to his island home, where he deploys about 50 units, mostly through government and private contracts.

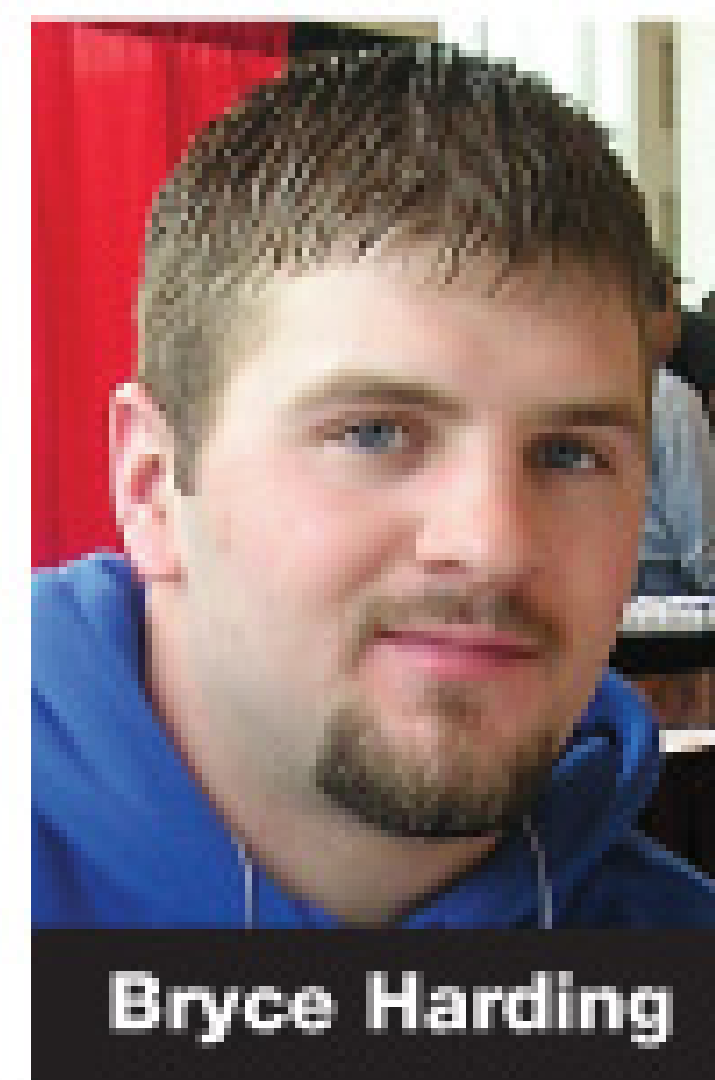

**Name:**  
Bryce Harding, co-owner  
**Company:**  
Harding Septic & Portables  
**Location:**  
Peshtigo, Wis.  
**Employees:** 4  
**Years in Business:** 8

"You're losing a lot of money by not coming to the Expo," says Bryce Harding, who operates the company with his father, Gerry. "You need to keep moving with your competitors, and if you're not here, they probably are."

Harding has three things in mind when he arrives at the show each year: education, equipment and networking. He and his dad take turns attending the show, with the other staying home to keep the shop running. Every so often, both will attend with Gerry's wife and Bryce's mom, Beth, as a mini family vacation. Then, they'll either get someone to answer their phones, or have calls forwarded to Beth's cell phone so they can be handled individually.

Equipment purchasing is a regular activity for the Hardings at the Expo. "We buy around 25 portables each year while we're here," Bryce Harding says. "We have about 130 units now. We've also purchased three trucks." He estimates they spend about \$12,000 each year on the show floor.

"Whether you're pumping septic tanks, renting portables, whatever, there's somebody at the Expo with that experience," says Keith Houk. "Most people are pretty friendly, it's an open environment, and you'll be amazed at the information they're willing to share with you. Whether it's disposal problems, maintenance or employee issues, you can ask whatever you need to know. And we make a lot of friendships, meeting the same people year after year.



**Keith Houk**

Name: **Keith Houk**  
 Company: **Keith's Tank Service**  
 Location: **Fayetteville, Tenn.**  
 Employees: **2**  
 Years in Business: **11**

"Networking is the number one reason I come, but I also buy equipment, spending about \$3,000 on up each year. We make this a working vacation, doing some shopping while we're here and enjoying the entertainment. We shut the shop down when we're gone. Emergencies are covered by someone, but since it's the same time each year, most of my regular customers are aware I'm gone. We present it to our customers that I'm getting my continuing education. They like that, thinking, 'Oh, you're a professional!'" ■

## Everyone's talking about it.

Find out why.  
 Get your **FREE** subscription today.

**ONSITE installer**

PROMOTING WASTEWATER TREATMENT QUALITY AND PROFESSIONAL EXCELLENCE

Visit [www.onsiteinstaller.com](http://www.onsiteinstaller.com) or call 800-257-7222.

### Steel Tanks

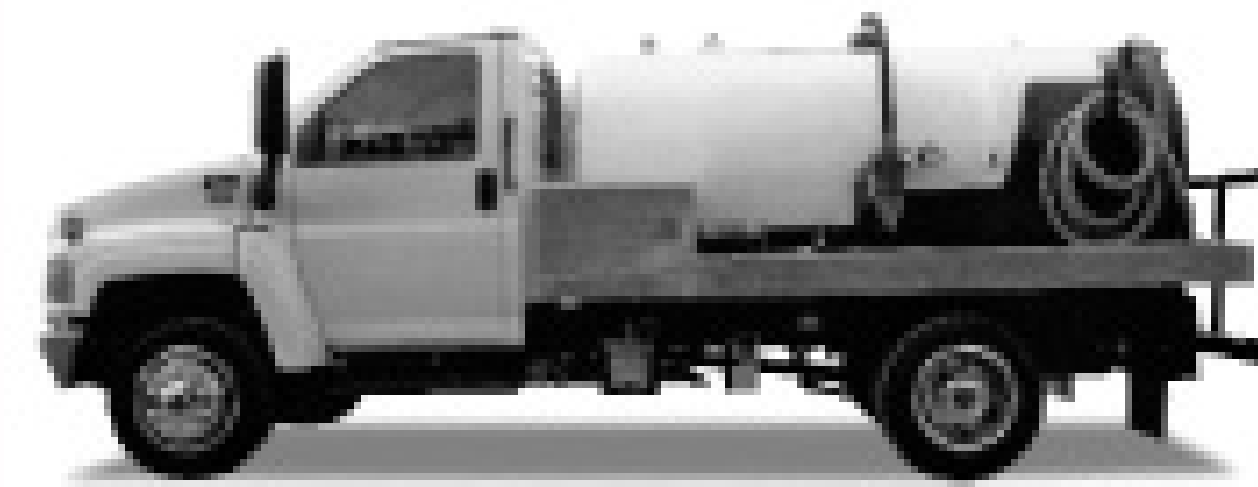

- Polished Aluminum Skirting and Tool Boxes
- 2008 GMC 5500 Duramax, Diesel, Allison Automatic Transmission, 19,500 GVW, 1000 waste, 350 fresh .....\$59,000
  - 2008 Ford, 6.4 Diesel, Automatic, 19,000 GVW, 950 waste, 300 fresh .....\$57,000
  - 2008 Dodge 5500, Cummins Diesel, Aisin Automatic, 1000 waste, 300 fresh, 19,500.....Now Available
  - 2007 Isuzu or W5500, Diesel, Automatic, 17,950 GVW, 750 waste, 300 fresh.....\$55,500

### Aluminum Tanks



by Amthor 5/16" Thick

- 2008 GMC 5500 Duramax, Diesel, Allison Automatic, 19,500 GVW, 1000 waste, 400 Fresh .....\$67,500
- 2008 Ford, 6.4 Diesel, Automatic, 19,000 GVW, 1000 waste, 400 Fresh .....\$65,500
- 2008 Dodge 5500, Cummins Diesel, Aisin Automatic, 19,500 GVW, 1000 waste, 400 Fresh...Now Available
- 2007 International DT-466, Air Brakes, Automatic, Under CDL, 1500 waste, 500 Fresh .....\$80,500
- Any Brand Truck Available
- Used Septic and Toilet Trucks Available



Portable Restroom Trailers

Dodge Trucks Coming Soon Check Our Prices.



8 RESTROOM | 10 RESTROOM | 12 RESTROOM | 14 RESTROOM | 16 RESTROOM | 20 RESTROOM

SLIDE-IN UNITS & USED TRUCKS AVAILABLE / MASPORT, JUROP & CONDE VACUUM PUMPS  
 CHECK OUR PRICES



**LANE'S VACUUM TANK, INC.**

3133 VANZORA RD. • BENTON, KY 42025

800.592.3308 • 270.527.9945

**T&T TOOLS**

**T&T TOOLS, Inc.**

FAX: 800.521.3260 | EMAIL: [sales@TandTtools.com](mailto:sales@TandTtools.com)

**800.521.6893**

[www.TandTtools.com](http://www.TandTtools.com)

CALL FOR A FREE CATALOG!

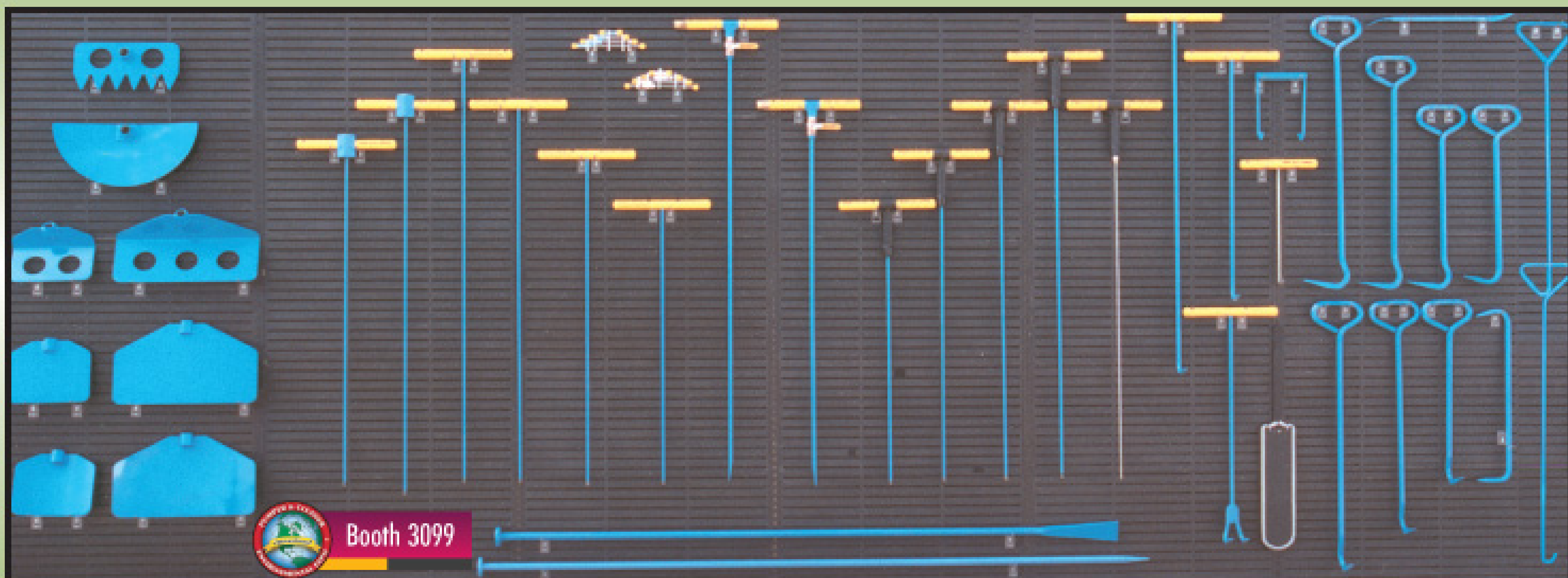

CALL FOR A FREE CATALOG!



Booth 3099

#### SCRAPERS...

High quality scrapers make scraping catch basins, septic tanks, pump trucks, etc. easy.

#### PROBES...

Insulated, standard, and specialty soil probes. Special 3/8" metal alloy shafts. Threaded and hardened tips.

#### HOOKS...

Specially designed Top Poppers make opening manhole covers a cinch. Try the Handy Hook for opening septic tank covers.



# Septic-Scrub™

## The Demonstrated Drainfield Restoration/Maintenance Solution

Backed By Science ■ Proven with Experience ■ Many Satisfied Homeowners

Septic-Scrub™ is a superior product for the maintenance and restoration of septic system drainfields. Customers appreciate that it is environmentally safe, contains no organic chemicals and does not produce any toxic by-products. Most importantly, **Septic-Scrub works.** It breaks down sulfide buildup in the biomat and soil to allow for better water absorption.

Learn more about Septic-Scrub at [www.arcana.com](http://www.arcana.com)

### arcana

P.O. Box 65  
Scotch Plains, NJ 07076-0065



Booth 4074

For information on increasing sales and providing a valuable service to your customers, call Arcan Enterprises at **888-35ARCAN (352-7226)**

## "DON'T BE EMBARRASSED AGAIN!" HOW AWFUL...

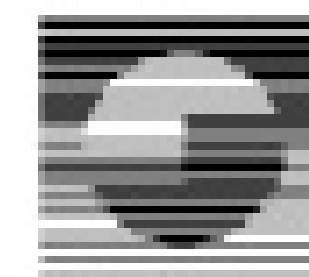

**800-622-8768**  
[sweetair.com](http://sweetair.com)

**SWEET SEPTIC SYSTEMS, INC.**  
5701 Mother Lode Drive • Placerville, CA 95667  
Fax: 530-622-1087

## SWEET AIR™ FILTERING DEVICE

PAT. PENDING

UPC Approved

## HOW WONDERFUL...



## Save Time! Save Money! With a Stellar Hooklift!



- One truck can support numerous bodies, which cuts cost and maintenance
- Over 40 models available, capacities up to 65,000 lbs.
- One truck operator can, without leaving the cab of the truck, load and unload or change truck beds in less than a one minute cycle
- Patented dump/load interlock system
- Gravity type safety latches are used to prevent accidental detachment of the body
- Rugged rear body tie-downs and large over-sized rear hinge pins to insure stability
- Low maintenance
- Unlimited uses



#5193 & 6193

## The Stellar Hooklift Interchange System...Explore the Possibilities!

**STELLAR**  
INDUSTRIES INC.

Our People.  
Our Products.

800-321-3741 • [www.stellarindustries.com](http://www.stellarindustries.com)





**IN STOCK!** *Septic/Grease Trap & Restroom Service Trucks*

**Contact: Jeff Hurst 800-692-5844** email: jhurst@west-mark.com  
 www.west-mark.com Tel: 209-537-4747 / Fax: 209-537-1753 / 2704 Railroad Ave, Ceres, CA 95307

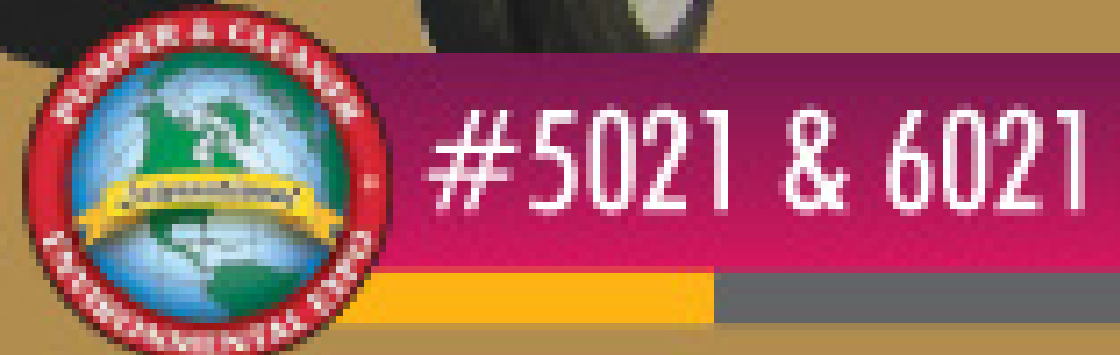

**NEW! 2008 Sterling Bullet - 20,500 GVW**

Cummins 6.7 Liter Turbo Diesel 305 HP  
 6 Spd. Auto, 7,000 lb. 13,500 lb. Axles,  
 Exhaust Brake, AC, AM/FM-CD, Cruise.  
**1500 Gallon PORTAVAC**  
 Masport HXL4 -1100 Waste / 400 Fresh,  
 Burks washdown / Hot Shift P.T.O.

**\$66,400**

Lease from **\$1328.** mo  
 4 Wheel Drive ... \$71,495

**NEW! 2008 Kenworth T300 - 22,000 GVW**

Cummins diesel, Allison automatic, Hydraulic brakes,  
 Air Conditioned, AM/FM, Air suspension drivers seat,  
**1700 Gallon PORTAVAC**  
 400 fresh / 1300 waste Masport HXL 4 Vac pump  
 with pre-filter, Burks DC 10 wash down,  
 Hot shift PTO w/ remote 4" Discharge,  
 Unit hauler and tow package.

**\$73,900** Lease from **\$940.** mo.



**2007 LT9500 Sterling**

58,000 GVW, 18/40 axles, MBEW 410/450 HP, 10 Speed  
**4200 Gallon** Masport 400CFM pump and Tool box

**\$128,000** Plus FET from **\$2,560.** mo



**2008 Peterbilt 33,000 GVW**

260 HP, 6 speed transmission, AC, AM/FM...loaded.  
**2800 Gallon** Masport HXL15, tool box.

**\$86,500** from **\$1,070.** mo



**Choice.** We offer **MORE** than all the others combined.  
 More choices of exteriors - *these are just a few!*



More choices of interiors - *many more online.*



Restroom Trailers | Shower Trailers | Combination Shower /  
 Restroom Trailers | ADA Trailers | Decontamination Trailers  
 Hand Wash Trailers | Drug Screen and Lab Trailers

Visit our Online Catalog - [www.ameri-can.com](http://www.ameri-can.com)

**More Choices...**

- 75 floorplans to choose from
- Wide range of exterior designs
- Choice of 9 unique interiors or design your own
- More Features
- More Options
- More Functionality
- More value for your investment



Booth 5053

**AMERI-CAN**  
 ENGINEERING  
 15886 Michigan Rd | Argos, IN 46501  
**574-892-5151**

**MyTana**

Check out our **NEW** website [www.mytana.com](http://www.mytana.com)



Your "eye" down the line!



Booth 8089

For a FREE Catalog... Call Toll Free: 800-328-8170 Fax: 651-222-1739 Request: [www.mytana.com](http://www.mytana.com)



# New Year's Savings at Lely



**80BBL OIL FIELD UNIT**



**THANKS TO CENTEX PORTABLE TOILETS**



**THE ORIGINAL GEM JET IS STILL THE BEST. 2000 PSI @ 15 GMP**

**Financing Available**



**300 + 100 GALLON READY TO GO UNIT THAT WILL FIT IN THE BACK OF YOUR PICK-UP**



**THANKS TINGLE SEPTIC**



**THANKS BONNIE**



**IN STOCK FOR IMMEDIATE DELIVERY - 1100 + 450 PORTABLE TOILET TANK ON A KW CHASSIS. CALL FOR DETAILS.**



**Booth 3140**

**WE HAVE STEEL TANKS IN STOCK READY TO BE MOUNTED ON YOUR TRUCK**

**LELY MANUFACTURING**



**LELY WASTE SOLUTIONS**

P.O. Box 789 • Wilson, NC 27893  
252-291-7050 • FAX: 252-237-7726  
E-mail: sales@lelyus.com

**800-334-2763**

**www.lelyus.com**

**SERVING THE LIQUID WASTE INDUSTRY FOR OVER 50 YEARS**

P.O. Box 1026 • Temple, TX 76503  
254-938-2564 • FAX: 254-938-7204

**800-367-5359**

Bruce Curry • Earl Ballard  
E-mail: bcurry@lelywaste.com

**www.lelywaste.com**



# POWERFUL PUMPS from GENERAL PUMP



Booth 8041



**NEW! Jetter Series**  
High Flow, High Pressure  
With Flows to 18 GPM,  
And Pressures to 4,000 PSI  
Designed for Sewer Jetting



**VS Series**  
High Flow, High Pressure  
With Flows to 16 GPM,  
And Pressures to 21,750 PSI  
Designed for Water Blasting



General Pump  
1174 Northland Drive  
Mendota Heights, MN 55120  
[www.generalpump.com](http://www.generalpump.com)

**RouteOptix** Inc.

- Customer Service
- Optimized Routing
- Visual Dispatch
- Asset Management
- Disposal Tracking
- Customer Billing

Booth 3027

**A Complete Software Solution**

(866) 926-7849

[www.routeoptix.com](http://www.routeoptix.com)

[info@routeoptix.com](mailto:info@routeoptix.com)

## TrakMats®

Ground Cover Mats For The Professional

- \* UV protected
- \* Tough, Lightweight
- \* Power Cylinder Cleats
- \* Hand cutouts for lifting
- \* 100% Recycled Material
- \* Unaffected by heat & cold
- \* Light color prevent burnt grass



No more Ruts,  
Damaged Lawns or Weather  
Delays.

No more Heavy, Wet, Rotten,  
Broken, Slippery Plywood

Booth 3031

[www.trakmats.com](http://www.trakmats.com)  
[sales@trakmats.com](mailto:sales@trakmats.com)

Charlotte, NC 28216  
Fax: 704.398.0540

800.762.8267

**SVE** Sales, Inc.





## NEW! 2008 Kenworth T300 - 22,000 GVW



Cummins diesel, Allison automatic,  
Hydraulic brakes, Air Conditioned, AM/FM  
Air suspension drivers seat, R.H. electric window  
Electric door locks, Turbo exhaust brake,

**1700 Gallon PORTA VAC**

400 fresh / 1300 waste Masport HXL 4 Vac pump  
with pre-filter, Burks DC 10 wash down,  
Hot shift PTO w/ remote 4" Discharge,  
Unit hauler and tow package.

**\$73,900** Lease from **\$940.** mo.

**PORTA VAC** portable restroom service trucks by



**NEW! 2008 Mid Range, Non-CDL Models**  
Factory Built with a 10 Year Tank Warranty

## NEW! 2008 Sterling Bullet - 20,500 GVW



Cummins 6.7 Liter Turbo Diesel 305 HP  
6 Speed Automatic  
7,000 lb. Front Axle, 13,500 lb. Rear Axle  
Exhaust Brake, AC, AM/FM-CD, Cruise,

**1500 Gallon PORTA VAC**

1100 Waste / 400 Fresh / Masport HXL4  
Burks washdown / Hot Shift P.T.O.

**\$66,400**

Lease from **\$1328.** mo  
4 Wheel Drive ... \$71,495



## ALUMAC TANK

### 2007 LT9500 Sterling

MBEW 410/450 HP, 10 Speed transmission  
58,000 GVW, 18,000 lb. / 40,000 lb. axles

**4200 Gallon Septic Service**

Masport 400CFM pump and tool box

**\$128,000** Plus FET

from **\$2,560.** mo

LaVerne Charlet



**Toll-Free: 1-888-848-3727**

email: [lctanks@bellsouth.net](mailto:lctanks@bellsouth.net) / fax: 270-898-4055

175 Cascade Drive, Paducah, KY 42003

# L.C. TANKS



# Basic Training

A new inspector asks for a step-by-step approach to working with the industry to encourage the most effective onsite systems for homeowners

By Roger E. Machmeier, Ph.D.

**Q I have learned about onsite sewage systems by attending a number of seminars and workshops. I have passed the required tests, am certified for inspections and am employed by the local department of health. One of my jobs next spring will be to inspect the installation of sewage systems. What are some things I should look for when performing an inspection?**

**A** Passing some tests does not really tell how much you have learned about onsite sewage treatment. Being certified is your “ticket” to learn a lot more.

Let’s hope you have a basic knowledge of how onsite systems work and how they should be installed. But your real education will begin when you get out into the field. If you have a colleague in your office, he or she would be a good place to turn for help. However, I sense from your question that you will be working on your own to conduct inspections.

One of the first things you should do is get to know the installers working in your area. The health department likely has a list of licensed installers. Send out a note or call each installer and introduce yourself. Explain that you would like to meet each one personally. Set up an informal coffee hour at a local restaurant where you provide the coffee and goodies. You might do that several times. It would be good to do this in the offseason when the

installers are not real busy.

Your introduction should state that you have the responsibility to work with the installers to make sure that the onsite systems are installed properly and according to code.

## IN THE TRENCHES

Ask the installers what they expect from you. Tell them that as an employee of the health department, you are obligated to enforce local codes for onsite sewage treatment systems. Ask the installers what they like about the code and what they don’t like about it. Find out if some provisions of the code are not acceptable to the installers. Maybe some changes are needed. Maybe some objectionable features are technically not sound. Listen to the installers’ comments.

Recognize that some of your installers have been in business for many years. They know what works and what doesn’t work for their customers. As you get started in your job, many installers will know much more about onsite sewage treatment systems than you do. Take on a humble attitude and learn from them. Also recognize that some installers are more knowledgeable than others. Learn which ones do the best jobs.

When inspecting onsite sewage treatment systems, what are some things you should do?

- First, inspect the site where the onsite system is to be installed. Be sure the system is laid out in the area where the site evaluation was performed. If this

is not true, the layout must be changed before work begins. The designer must be contacted and the system properly located. This is your job and not the job of the installer. When the installer comes to the jobsite, the system should have been approved by you.

- With a trench system, the excavation of trenches must not take place if the soil is wetter than the plastic limit. You will be given the argument that the onsite system is needed right away by the homeowner. However, insist the septic tank be used as a holding tank and pumped until the soil is dry enough for proper trench installation. You will be doing any future homeowners a favor by insisting the onsite system be properly installed. This is where your basic knowledge will be useful.

- Drop by installations unannounced. Inspect the installation activities. Look at the trench sidewalls to see if the soil has been smeared. Look for footprints and other activity in the bottom of the trench that might smear the soil. Inspecting a trench after the rock is placed will tell you little about what went on during installation.

- Check the gravity distribution system for sewage tank effluent. Hopefully your local code will specify the use of drop boxes for serial distribution. The drop boxes should bring the effluent

level to the top of the trench rock. Geotextile fabric must be placed over the top of the rock to prevent soil cover from filtering down into the rock layer.

- If distribution boxes are used, do not allow the top of the rock in the lowest trench to be lower than any outlet of the distribution box. This feature must be part of the system design. If the lowest trench becomes overloaded, effluent will back up to the distribution box and flow to other trench outlets. It will prevent seepage of effluent to the ground surface from an overloaded trench.

- While it is important that the top of the trench rock be level throughout the length of each trench, don’t be a “nitpicker.” It is most important that the far end of the trench is at the same elevation as the head end of the trench. If some of the top rock layer is a little higher or lower, point this out but don’t insist on absolute perfection. What you should be looking for are major violations of the sanitary code that will affect future operation and life of the system.

## COMING NEXT MONTH

The answer to this month’s question will continue in the *Septic System Answer Man* column next month, as I discuss mound systems and other features of onsite systems. ■

Readers are welcome to submit questions to the Answer Man. Send your question to COLE Publishing by e-mail to [editor@pumper.com](mailto:editor@pumper.com), by fax to 715/546-3786; or by mail to P.O. Box 220, Three Lakes, WI 54562. We will pass your question along to Dr. Machmeier.





# SAVE Over \$5,000 A Year!

**By Saving  
1,800 Gallons  
of Fuel!**



- **24-Volt Electric Driven Vacuum System** replaces Engine Driven PTO System
- **Electric Hybrid Allows Vehicle Shutdown at Every Stop!**
- **Engine Does Not Run During Services**
- **Save THOUSANDS in Annual Fuel Costs on EACH Truck!** (Based on 40-8 minutes services per day)!
- **Super Quiet! Service Noise Restricted Areas with Ease**
- **Optional Onboard Management System**

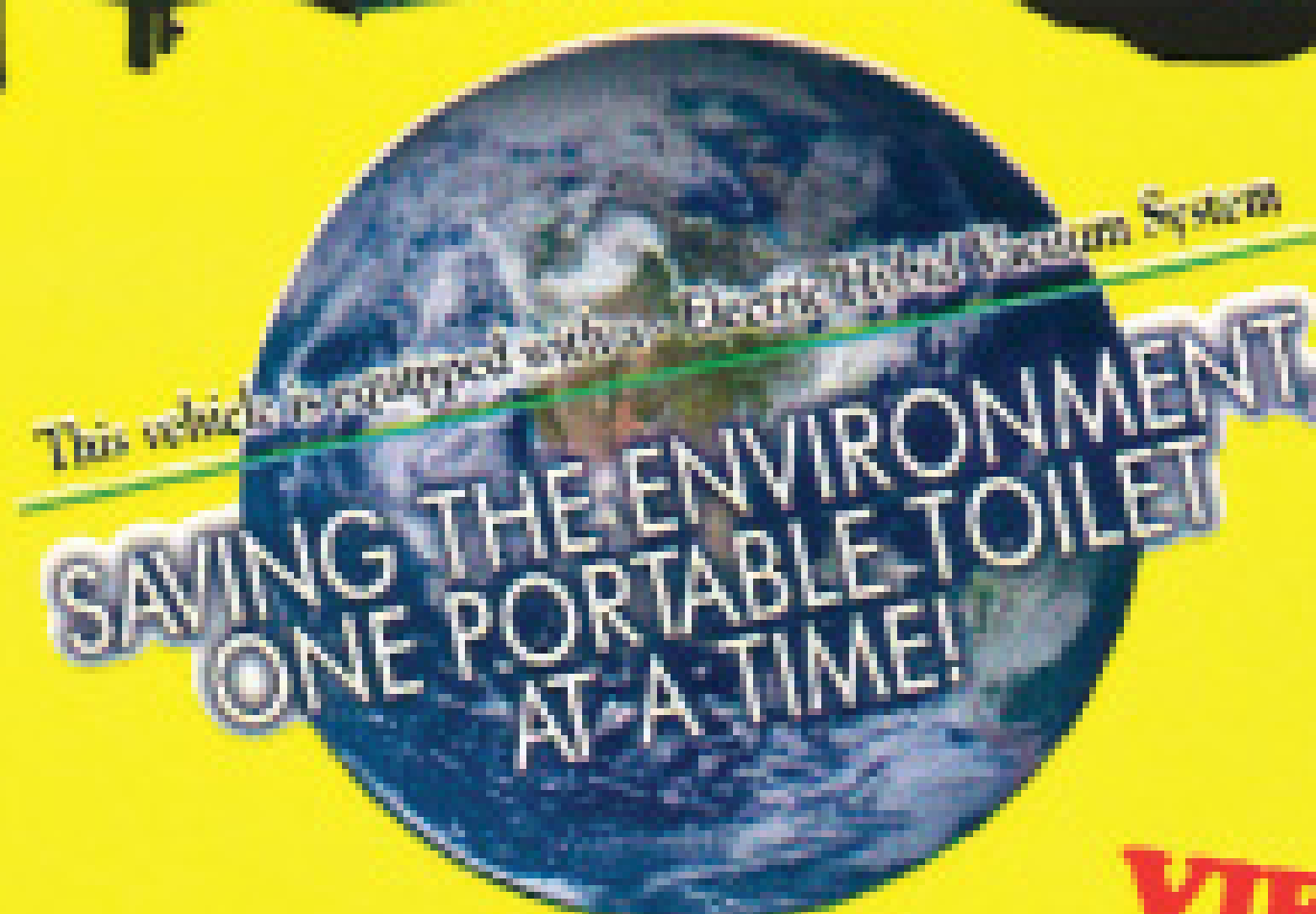

**VIEW A  
VIDEO CLIP  
OF THIS HYBRID  
ON OUR WEBSITE!**



**1-800-927-8750**

**www.fmitrucks.com**

## **Just Starting Your Business? YOU NEED A SERVICE TRAILER!**



- **Twin Poly 75 Gallon Fresh Water Storage**
- **325 Gallon Waste Capacity**
- **Low WorkMate Easy Work Station**
- **Great Product Storage**
- **Upgraded 5,200# Axes**
- **Pick Up & Deliver Two Units**
- **Super Low Operating & Insurance Costs**



**Under  
\$15,000  
COMPLETE!**

**Visit us at the  
Pumper Show  
Booth 4002/4003**

**WORK  
MATE**  
A Division of FMI Truck Sales & Service  
**SANITATION INNOVATIONS**  
**FMI TRUCK SALES & SERVICE**  
Portland, Oregon



# Built Better to Perform Better



**NEW!**  
Dual Pedestal Reel

**Very strong, yet compact  
vibration-resistant new design**

## Better by Design:

- ✓ Engineered for your most demanding vehicle-mounted applications
- ✓ Innovative new heavy duty design
- ✓ Very compact...fits in tight spaces
- ✓ More resistant to vibration
- ✓ Durable, powder-coated finish ensures maximum resistance to corrosion
- ✓ Innovative latching mechanism prevents hose latch-out
- ✓ Ask about Reelcraft's full range of hose reel products



**Military Tested**  
Rely on Reelcraft's Series DP7000 for greater resistance to vibration. Series DP7000 meets or exceeds military Vibration for Truck Transport testing: MIL-STD-810F, 500,000 mile equivalent.



**800-444-3134**  
[reelcraft.com/pumper](http://reelcraft.com/pumper)

Reelcraft Industries is  
**ISO 9001:2000**  
Certified since 1996

**REELCRAFT**

*Wind Things Up With Reelcraft*

# Flexible and Affordable Financing Options



## Financing for New and Used Equipment:

Trucks	Tanks
Trailers	Toilets
Cameras	Jetters

also Computer Hardware & Software



**Booth 3127**

7 Church Road Hatfield, PA 19440  
Phone: 800.422.1844 Fax: 888.883.9380  
Visit our website: [www.libertyfg.com](http://www.libertyfg.com)

**COMMERCIAL EQUIPMENT FINANCING**  
**CALL 800-422-1844**

When it's forty miles out and forty miles back,  
**Pump failure is not an option.**



When you need to trust your equipment, insist on NVE vacuum pumps.



Designed and built with the customer in mind – resulting in dependable, high performing pumps that are easy to install, operate and service.



Booth 8149

[www.natvac.com](http://www.natvac.com)

800-253-5500 - 2670 Aero Park Drive - Traverse City, MI 49686

**NVE**

Powerful. Performance.





Booth 6045

# wallenstein

portable sanitation

- > Quality construction
- > Rugged design
- > Wide fiber vanes
- > Easy internal access
- > Low noise level
- > Two year warranty

## The most rugged, dependable, longest lasting vacuum pumps in the industry!



Model 302



Model 402

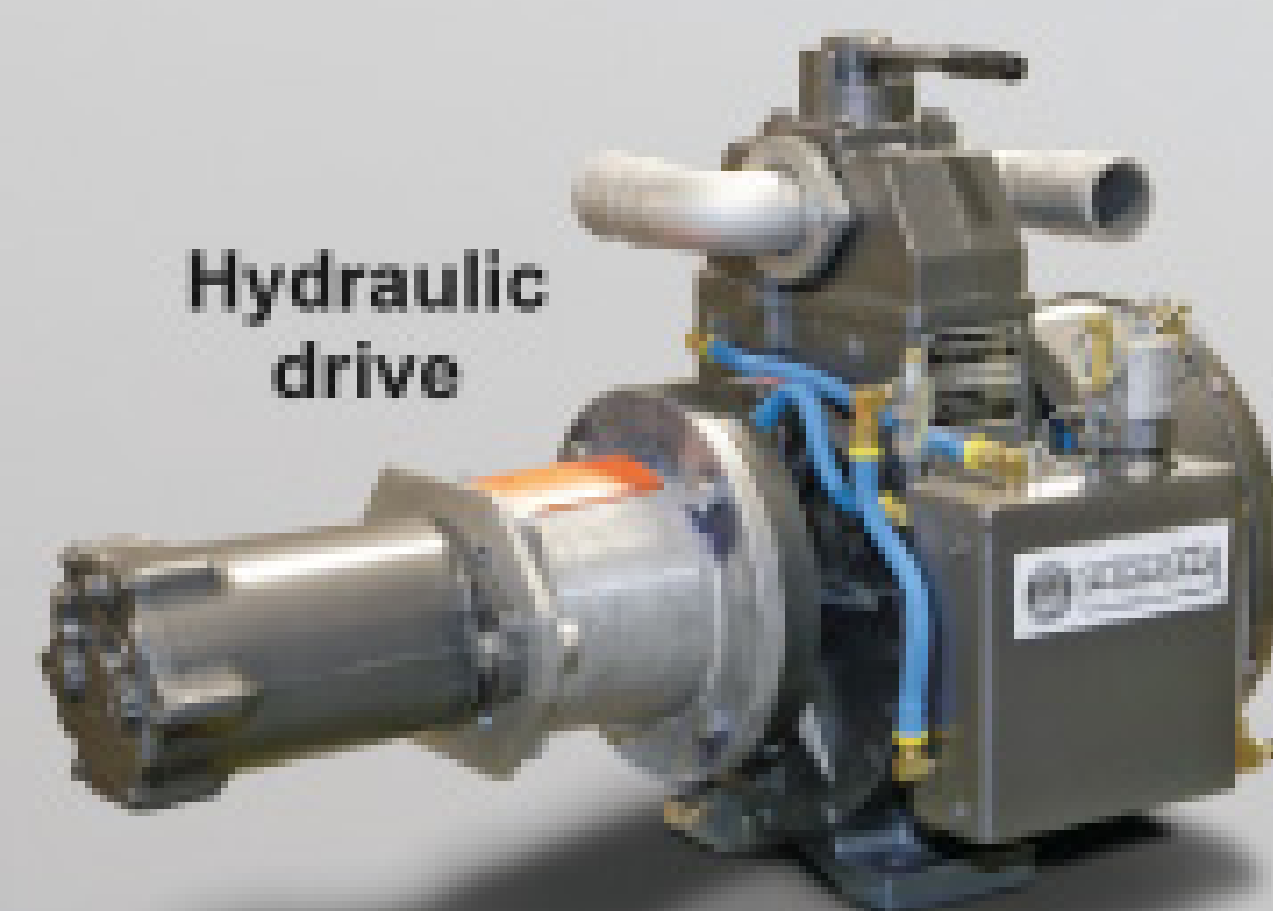

Hydraulic drive

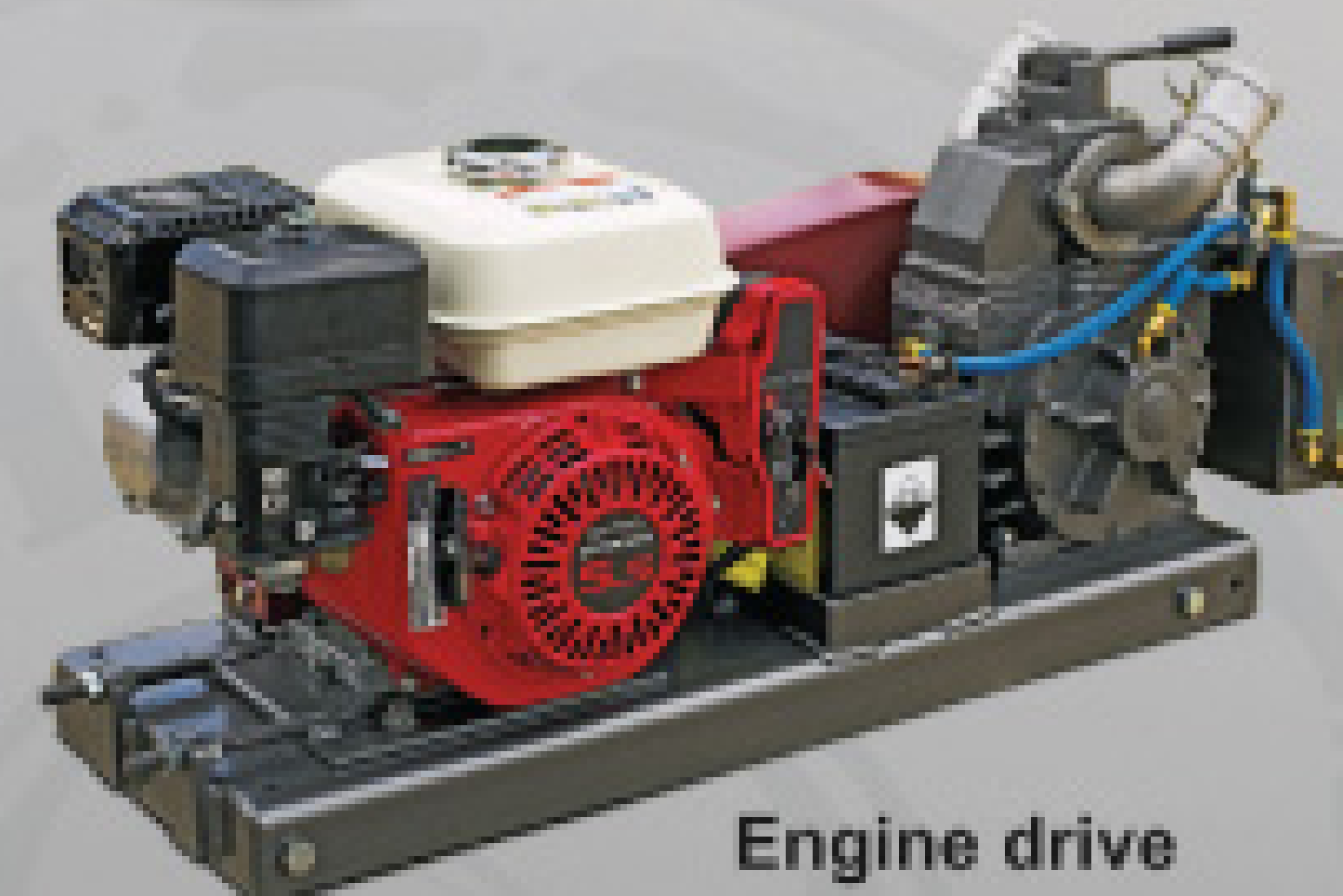

Engine drive

CALL FOR PRODUCT LITERATURE AND YOUR NEAREST AUTHORIZED DISTRIBUTOR

Series	Rating CFM	Vacuum *HG	HP <sup>gross</sup> or <sup>total</sup> Engine	Tank Size US Gallon
151	80 @ 1750	27	5.5	500
202	115 @ 1150	27	11	750
302	165 @ 1150	27	13	1100
402	200 @ 1150	27	18	1500+

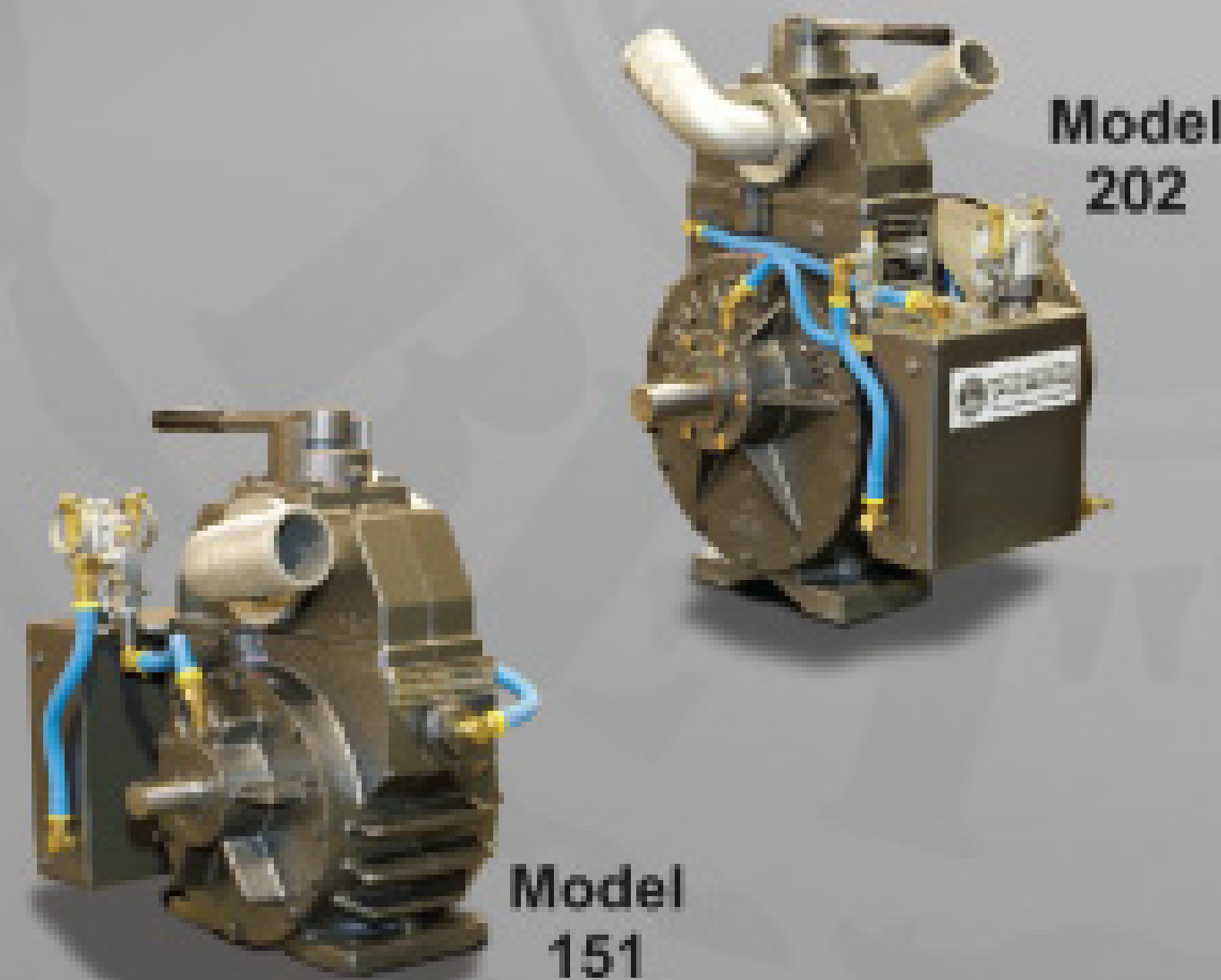

Model 151

Toll Free 1-800-801-6663 fax 519-669-8331 email [info@wallensteinpumps.com](mailto:info@wallensteinpumps.com)

Toll Free 888-207-2074

Fax (479) 770-6089

### WILCOX TRUCK SALES, INC.



Lowell, Arkansas

... ESTABLISHED 1978

I-540 Exit #78 & Hwy 71B

2 hours East of Tulsa or 1.5 hours South of Joplin

[www.wilcoxtrucksales.com](http://www.wilcoxtrucksales.com)

#### 1999 Mack CH613

E7 Mack, 427 HP, 10 Speed, Engine Brake, Excellent Matched Drivers, A/C, P/S, Cruise Control, Air Ride with New Timbren Suspension Enhancements, New 80 Barrel Custom Built & Painted, Machine Welded Vacuum Tank and New Jurup R260 Vacuum Pump



#### 1999 Mack CH613

E7 - 350/380 Mack, 10 Speed, Air Ride with New Timbren Suspension Enhancements, New Steer Tires, New G167 Driver Caps, New 3,150 Gallon Custom Built & Painted Machine Welded Vacuum Tank, 3 Large Manways, and New Jurup R260 Vacuum Pump



#### 1994 Kenworth W900

3406 Cat, 425 HP, 10 Speed, Engine Brake, Excellent Radials, 8 Bag Air Ride with New Timbren Suspension Enhancements, New 80 Barrel Custom Built & Painted, Machine welded Vacuum Tank and New Jurup R260 Vacuum Pump



## When Service Life is Important, Get the 25-Year NO Rust Guarantee

- Dewatering Systems
- Composting Systems (ECS)
- BOD COD Reduction Systems
- Polymer Systems
- Financing Available

**It's Smart to Protect Your Investment, Get the SMART 25-Year Guarantee!**



Multiple Purchase Options Available with Financing

If you want experience, give John a call.

**1-800-899-1802**

P.O. Box 782265 • San Antonio, TX 78278

**210-269-3910**

[www.smartdewatering.com](http://www.smartdewatering.com)

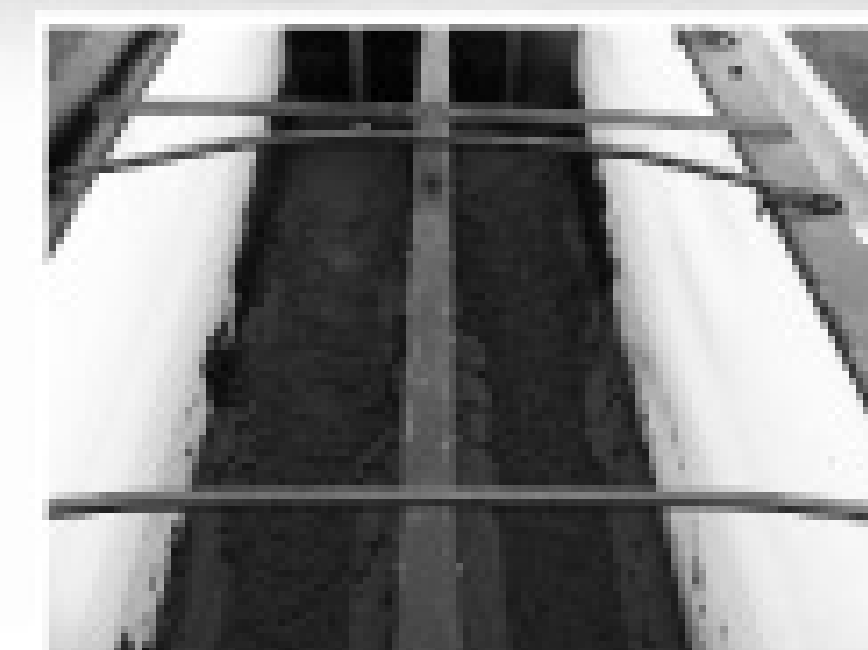



# VAC-CON

## MORE POWER TO YOU

# PRE-OWNED EQUIPMENT



Booth 1202



**2002 VAC-CON V390LHA/1000**

- 2002 STERLING L7501
- 275 HP / Allison MD3060
- 60 @ 3000 / CUMMINS 130 HP
- Mileage: 35,500

RECONDITIONED **\$158,000**



**1997 VAC-CON V312THAE/1300**

- Ford LNT8000 / 275HP / MD3060
- 50 @ 3000 Water Pump
- Mileage: 66,703 (kilometers)

RECONDITIONED **\$140,000**



**2003 VAC-CON V390LHAD**

- 2003 STERLING L7501
- 275 HP / Allison MD3060
- 60 @ 3000 / Cummins 130 HP
- Mileage: 44,700

< SOLD >



**1998 VAC-CON VPD3612LHA**

- 1999 IH 2554
- 275 HP / Allison MD3060
- 80 GPM @ 2000 PSI
- Mileage: 116,000

RECONDITIONED **\$138,000**



**2001 VACTOR 2103-16**

- 2001 International 4700
- IH T444E / Allison MD3060
- 40 @ 2500 / Roots Blower
- Mileage: 189,000

< SOLD >



**1998 VAC-CON VPD3690SHA**

- 1998 FORD L8501
- CAT 250 HP / 7-SPEED
- 70 @ 2000 / John Deere 4045T
- Mileage: 115,000

RECONDITIONED **\$115,000**



**2001 VAC-CON V311LHA/1000**

- 2002 Sterling LT7501
- CAT 275 HP / Allison MD3060
- 60 @ 2000 / Cummins 110 HP
- Mileage: 40,000

RECONDITIONED **\$155,000**



**1997 VAC-CON V316THA/1300**

- 1996 FORD LTS9000
- 300 HP CAT / 10 SPEED
- 80 @ 2000 / John Deere 4045T
- Mileage: 78,500

RECONDITIONED **\$149,000**



[www.vac-con.com](http://www.vac-con.com)



Ultimate Lease Hotline:  
**888-817.1757**

969 Hall Park Drive • Green Cove Springs, FL 32043 U.S.A.  
Tel: 904-284-4200 • Fax: 904-284-3305  
[www.vac-con.com](http://www.vac-con.com) • [vns@vac-con.com](mailto:vns@vac-con.com)



**Quality Vacuum Trucks... BUILT FOR YOUR BUSINESS**

**America's Leader in Truck Mounted Tanks**

**nationwide • worldwide**



Booth 4053

TRI STATE TANK, L.L.C.

**1-800-971-7657**

**www.tstllc.com**

(e-mail us from our website)

- Aluminum, Steel and Stainless Tanks
- Stock Tanks and Trucks • Units Ready to Go
- Lease Purchase Options



- Combo Units with Fresh Water Compartment



- Non-code Aluminum with Hoist & Full Opening Rear Door



## Kanaflex® 220RS Rubber All-Weather Suction Hose

### SUPER FLEXIBLE IN COLD WEATHER

Call for Low Prices on 100' Lengths & Coupled Hose Assemblies

A revolutionary new method of manufacturing rubber suction and discharge hose has drastically reduced costs to hose users. The new process, ten years in development, utilizes Kanaflex SBR TYPE "T" POLYMER to give the lightweight, rubber hose outstanding flexibility and long life.

New Series 220 rubber suction and discharge hose has excellent dimensional stability and is easy to couple. Manufactured in six sizes from 1-1/2" through 6", the hose is available in 100' lengths. I.D. and O.D. are smooth. Temperature range is -40° F to 160° F – ideal for industry and construction job site use.



SAVINGS UP TO  
**50%**  
FOR SUCTION & DISCHARGE HOSE USERS!

Distributors of: **Dunlop • Goodyear • Kanaflex • Plastiflex Hi-Vac & Other Hose • P-T & Evertite Quickcouplers Dixon & Le-Hi Couplings • Hose Clamps • Banding Equip.**

# MRP

**Toll-Free**  
**1.800.325.3730**

Milwaukee Rubber Products, Inc.

[www.milwaukeeerubber.com](http://www.milwaukeeerubber.com)

MAILING ADDRESS: P.O. Box 451 • Butler, WI 53007

FAX: 262.781.1742

WAREHOUSE: N52 W13319 Falls Creek Ct. • Menomonee Falls, WI 53051

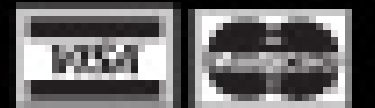

## Introducing...

Now Available!  
**18"**

### the Most Durable & Economical Septic Lid in the Market Today.

- Durable Roto-Molded Construction WILL NOT Crack Like Concrete!
- Lightweight Polymer is Easier to Handle & Transport
- Corrosion Resistant Stainless Steel Screws Included
- For use with Standard 18" & 24" I.D. Corrugated Pipe
- Easy Slide-in Installation
- Optional Sand Filled

Cost Effective  
**6 Pack Shipping**



Give Us a Call for More Information

**800.868.0973**

**Don't Waste Money On Expensive Riser Systems!**



Our **VALUE** goes deeper than you realize.

When it comes to portable sanitation solutions, WALEX delivers much more than blue deodorizers and accessories. We're giving you **innovative research & development** that has set all the current standards for excellence. You're getting **proprietary breakthroughs** that our competitors can only emulate. When you choose WALEX, you're not only getting **the best on the market today** — *you're also supporting your industry's future.*



**Booth 2209**

For more information, contact us at **910.371.2242**, toll-free **800.338.3155**  
or visit our website at **[www.walex.com](http://www.walex.com)**.



## United Site Services Acquires Cascade Phillips

United Site Services of Boston has acquired Cascade Phillips Co. and its seven service companies in Oregon and Washington. Included in the purchase are Seacoast Portables & Septic, Astoria, Ore.; Northwest Sanitation in Salem and Clackamas, Ore.; VALCO, Roseburg, Ore.; Sanipot, Eugene, Ore.; Cascade Phillips in Salem and Clackamas, Ore.; Advantage, Vancouver, Wash., and Emerald Sanitary Service in Seattle and Tacoma, Wash. With the acquisition, USS now serves customers in 19 states with 56 locations.

## McQuestion Joins Hoot as Sales Manager

Brian McQuestion has joined Hoot Systems LL as Midwest regional manager and national sales manager. A graduate of the University of Wisconsin, he is licensed as a POWTS maintainer with the Wisconsin Department of Commerce and serves as secretary/treasurer of the National Onsite Wastewater Recycling Association. ■

# REVOLUTIONIZE your pump

With the new, advanced vane pump blades from AIC:  
**DuraBlade™**



AIC's new DuraBlade increases run-time between maintenance. A better blade really can make your pump run longer without effecting critical components!

- Fabricated to exact tolerances
- Specially heat treated
- Operates at lower temperatures
- Produces less friction
- Increased stability and resistance to warpage

**DECREASE DOWN TIME & SAVE MONEY!**

**Join the revolution for better pump performance —  
call AIC today!**

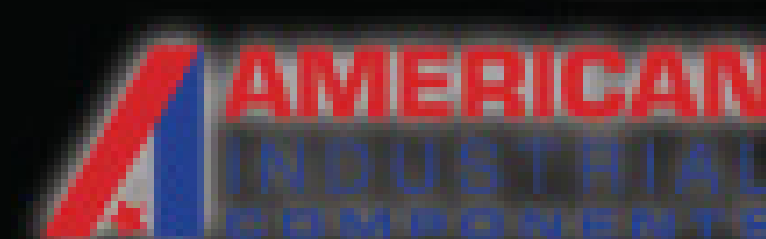

811 Industrial Loop  
Breckenridge, TX 76424  
Toll-free: 800-272-7557  
Fax: 254-559-7550  
www.aicdover.com



High Performance  
Thermoset Composite  
Another high-quality  
engineered laminate  
from Norplex Micarta

## LEASING SOLUTIONS



If you have special or unique needs,  
for straight answers and a quick  
response, call Jim Thomas.

Conserve your working capital. Keep existing credit lines intact, and enjoy the security of knowing financing is there when you need it. We offer loan and leasing plans tailored to individual needs.

- Portable Toilets
- Sewer Equipment
- Pumper Trucks
- TV Inspection
- Water Jetters
- New and Used Equipment
- Vacuum Trucks

- Programs offer longer terms for older equipment.
- We do start ups.
- 90 Day Delayed Billing.
- Seasonal Payment Programs Available

**Get Pre-Approved for the Pumper  
& Cleaner Environmental Expo**

Prompt, no nonsense financing designed to meet individual requirements. Payment plans that are generally lower than other finance plans. With years of experience, we understand the competitive nature of your business.  
**We're prepared to act quickly and decisively!**

**Toll-Free 877-333-4539 • www.keycommercial.com**



# ABERNETHY

**WELDING & REPAIR INC.**

Vale, North Carolina 28168

Call Bill Abernethy at **1.800.545.0324**

Fax: 828.324.2401 • E-mail: [abernethyinc@charterinternet.com](mailto:abernethyinc@charterinternet.com)

authorized distributor for:



[www.abernethywelding.com](http://www.abernethywelding.com)

**2008's  
Are Here!**

- International
- Ford • GM

## 2007 CHEVROLET 8500 SERIES

2500 gal. tank, 6-spd., 250 hp

Only  
12 Pre-  
emission  
Trucks  
Left

## 2008 PETERBILT

2500 gal. tank, 2 with 6-spd.

## 2007 KENWORTH T300

2500 gal. tank, 6-spd., 260 hp

## 2008 INTERNATIONAL 4400

2500 gal. tank, Auto transmission

### NEW PORTABLE TOILET UNITS:

## (2) 2007 INTERNATIONAL 4300s

1500 gal. portable toilet service units, Auto transmission

## 2007 5500 CHEVROLET

1000 gal. 700 waste / 300 fresh

## 2007 HINO

1500 gal. portable toilet service units, 1100 waste/400 fresh

## 2007 FORD F750

1500 gal. portable toilet service units, 1100 waste/400 fresh

**WE WILL CUSTOM BUILD YOUR TANK UP TO 5000 GALLONS!**

600-1500 Gallon Portable Toilet Trucks: Our Truck or Yours

### SEVERAL GOOD, OLDER TRUCKS TO CHOOSE FROM:

- (2) 1995 Internationals  
2500 gal. tank
- 1997 Volvo  
4000 gal. tank
- 1998 Volvo  
4000 gal. tank

### PORTABLE TOILET UNITS:

- 2007 Ford F750  
1500 gal. tank
- 2007 Hino  
1500 gal. tank
- 2000 Isuzu  
800 gal.
- 1999 Freightliner  
1500 gal.
- 1999 Sterling  
1500 gal.
- 1991 4700 International  
1400 gal. tank

**MANY OTHER  
UNITS IN STOCK!**

**CALL  
FOR UPDATE**



**2008 International 4400E Series,**  
260 hp diesel DT 466 engine, 6-spd. trans. and world class auto, air brakes, 33,000 GVW, air conditioned, 2500 gal. tank, Masport HXL400 pump. **IMMEDIATE DELIVERY!**  
Also, 2500 and 3500 gal. tanks **READY FOR IMMEDIATE DELIVERY.**



**2007 International 4300,**  
220 hp DT466, Allison auto. trans., air brakes, 25,999 GVW, air conditioned, total tank capacity: 1100 waste/400 fresh, Masport HXL75V pump. **IMMEDIATE DELIVERY!** Also, 1500 gal. tanks **READY FOR IMMEDIATE DELIVERY.**

*Check with us on financing for the purchase of a new truck!*

### COMPLETE PARTS AND IN-HOUSE SERVICE FOR:

AIC Vanes • Moro • Battioni • Jurop • Masport • Fruitland • NVE • Powerflo • Plus many other brands

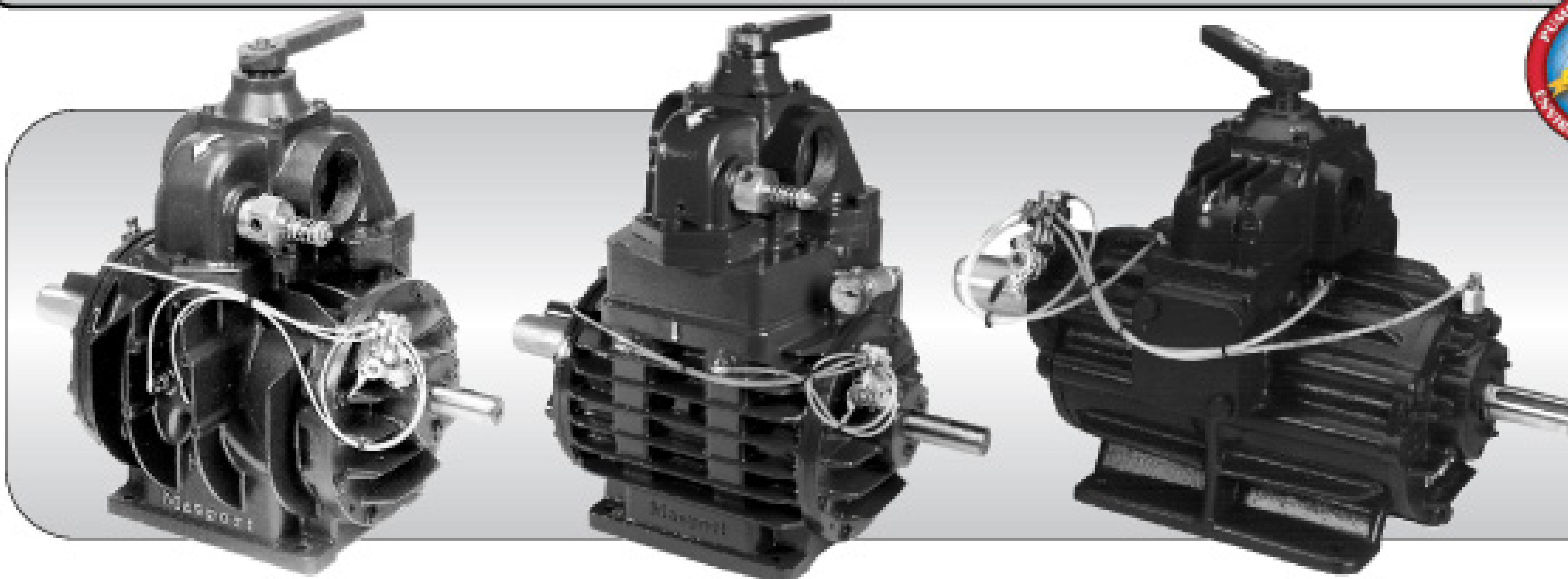

**Booth 7057**

**Complete Line of  
Masport Pumps  
Available**

**Immediate Delivery**

**OVERNIGHT DELIVERY ON PARTS • SAME DAY SHIPMENT ON PUMPS**

**WE SPECIALIZE IN PORTABLE SANITATION AND SEPTIC PUMPING EQUIPMENT**



# HOSE & HOSE ASSEMBLIES

Celebrating 56 Years



Booth 3137

FEATURING QUALITY HOSE AND COUPLING PRODUCTS BY:

abbott  
Rubber Co., Inc.

Kanaflex

BANJO

GOODYEAR

PLASTIFLEX

Parker  
Industrial Hose



tigerflex

O.E.M. INQUIRIES INVITED!

MANUFACTURED TO YOUR EXACT HOSE NEEDS BY THE LEADING SOURCE IN HOSE FABRICATION

OVER 20 DIFFERENT TRANSFER HOSE CONSTRUCTIONS AVAILABLE

CALL US TODAY FOR A PROMPT QUOTE OR CATALOG

1-800-852-1855 FAX: 847-952-0156

e-mail: [sales@pumperhose.com](mailto:sales@pumperhose.com)

NEXT DAY SHIPPING AVAILABLE FOR ALL STOCK ITEMS

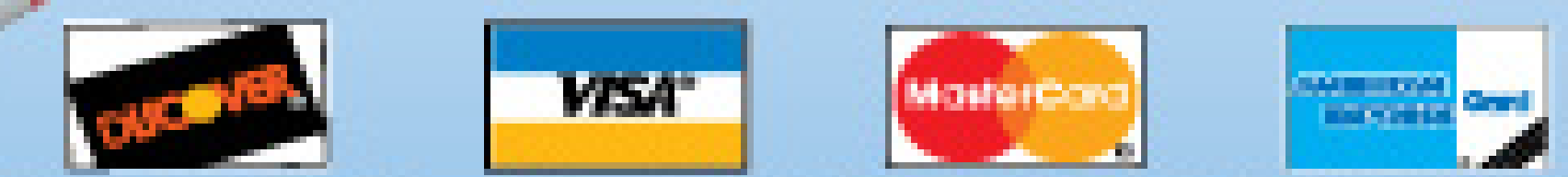

# ABBOTT RUBBER COMPANY, INC.

2143 LUNT AVENUE ELK GROVE VILLAGE, IL 60007 [www.pumperhose.com](http://www.pumperhose.com)

ARMSTRONG  
EQUIPMENT  
INC.

## MODEL 806B SEELEVEL ANNIHILATOR™

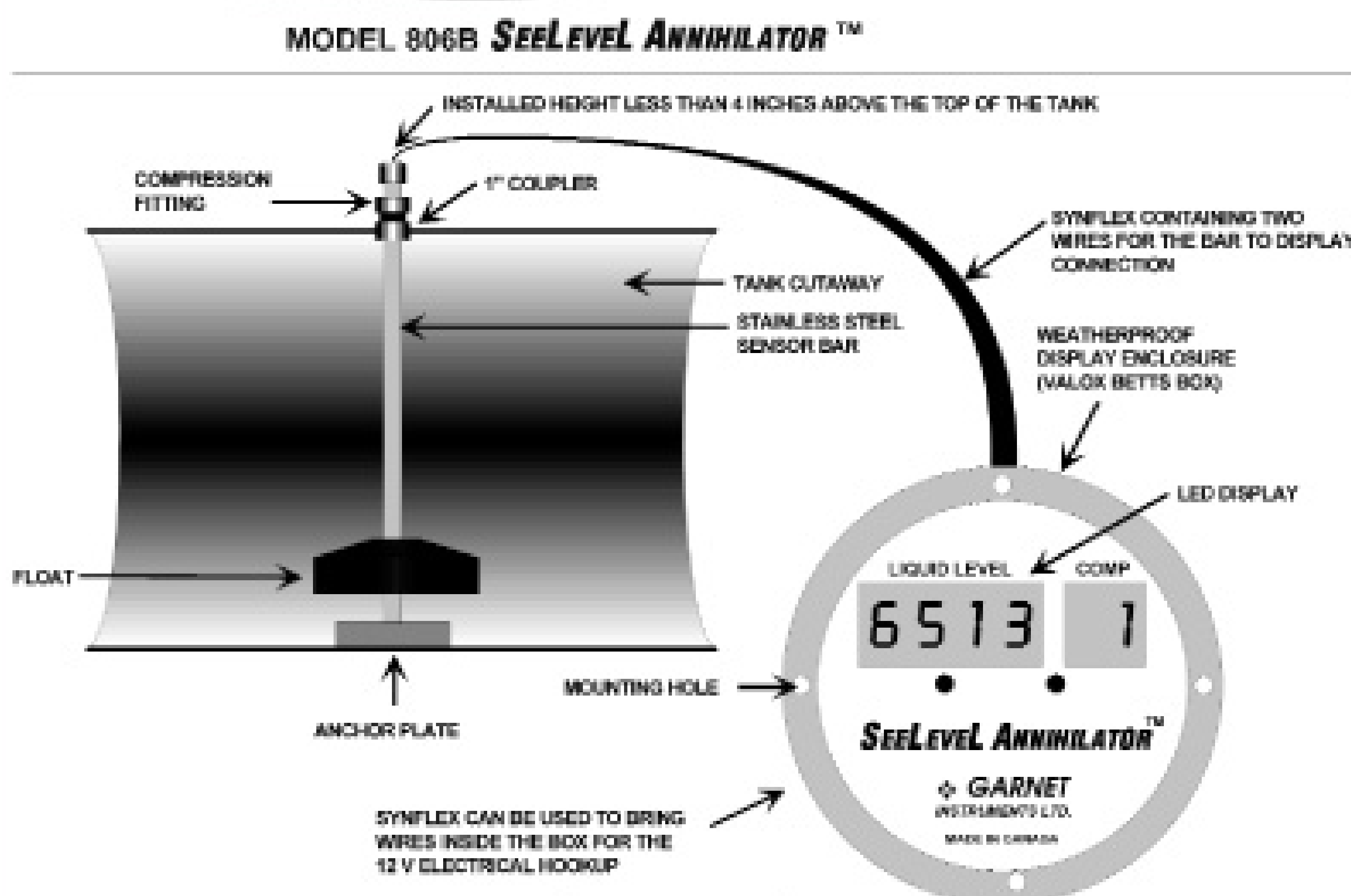

- Accurate Readings to 1/4"**  
Even with vacuum or pressure on the tank. No need to shut down pumping to check tank level.
- Protect Your Pump, Avoid Spills**  
See the level of your tank throughout the pumping process.
- Work Safely**  
Can be programmed to control warning devices.
- Maximize Efficiency**  
Avoid unnecessary trips. Can I get one more load, or should I head for the dump? The guessing game is over.
- Plan Your Route**  
Tracking customers tank size allows for improved route planning.
- Communicate With Your Customers**  
Pumping 1500 gallons from a 1000 gallon tank indicates problems.

These are all good reasons to equip your next truck with a SeeLevel model 806B liquid level gauge system. The 806B can be programmed to read liquid levels in up to three compartments with only one display. It can also accept up to three alarm settings for triggering a warning light, sounding an audible alarm, or closing a loading valve; all while the tank is loading.



11200 Greenstone Ave. | Santa Fe Springs, CA 90670  
800.699.7557 or 562.944.0404 | fax: 562.944.3636  
e-mail: [sales@vacpump.com](mailto:sales@vacpump.com) | web: [www.vacpump.com](http://www.vacpump.com)

To find out if the 806B can benefit your business, contact your tank manufacturer or call us  
**Toll Free at 1-800-699-7557**

**NEW! Work-Ready - Mid Range Kenworth & Sterling**  
**Chassis featuring PORTAVAC...**  
**The Industries Finest Light Weight Aluminum Tank.**



**2008 Sterling Bullet - 20,500 GVW**

Cummins 6.7 Liter Turbo Diesel 305 HP  
 6 Speed Automatic  
 7,000 lb. Front Axle, 13,500 lb. Rear Axle  
 Exhaust Brake, AC, AM/FM-CD, Cruise,  
**1500 Gallon PORTAVAC**  
 1100 Waste / 400 Fresh / Masport HXL4  
 Burks washdown / Hot Shift P.T.O.

**\$66,400**

Lease from **\$1328.** mo  
 4 Wheel Drive ... \$71,495

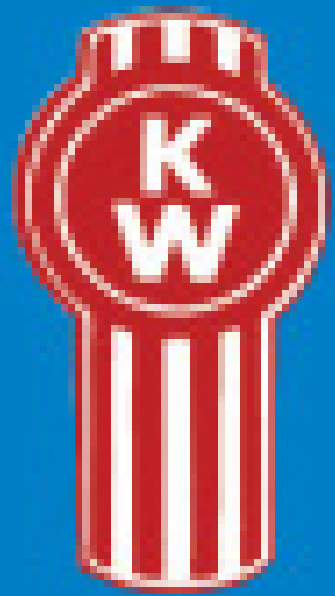

**2008 Kenworth T300**

22,000 lb G.V.W. rating – Non CDL  
 Cummins, Allison automatic,  
 hydraulic brakes, A/C, AM/FM, air driver's seat,  
 turbo exhaust brake.

**1700 Gallon Aluminum**  
 400 fresh / 1300 waste

Masport HXL 4, Burks washdown, Hot shift PTO,  
 4" discharge. Unit hauler & tow package.

**\$73,900** from **\$940** mo.

**2008 Peterbilt 340**

Cummins diesel, 10 Speed Transmission

**3600 Gallon ALUMATANK Septic**

Masport HXL15 - 360 CFM Pump, Tool Box



**\$102,000** Plus FET

Lease -To-Own from... **\$1,298** mo.



**Great Lakes Equipment, Inc.**  
 Chicago, IL  
 Fax: (815) 462-4017  
 Email: [info@greatlakes-equipment.com](mailto:info@greatlakes-equipment.com)  
[www.greatlakes-equipment.com](http://www.greatlakes-equipment.com)

**Call: (815) 955-3790**





## Classy Truck of the Month



Booth 4127

# Comforts of Home

Services, Inc.

## LUXURY TRAILER SALES

- Restroom & Shower Trailers, including 53' Semi Units
- Lowest Interior Floor Height in the Industry
- High Privacy Partitions are Standard for Added Comfort
- Unlimited Floor Plans from 8' to 53' Trailers
- ADA wheelchair accessible units.
- Rigid Steel Shell Construction from top to bottom to resist rot and warping.
- Rigid Platform, our smallest wide body trailers start out with Dual 10" ASTM I-Beams.
- 24/7 Tech Support for the best customer service available.
- Full 3 Year Warrantee, excluding normal wear and tear items.
- Free Nation Wide Lead Program for our customers.
- Dexter Torsion Axles for stable towing.

**Now standard on all Trailers:**

- Easy Fold-Up Steps & Door Handles
- Large Capacity Waste Tanks

| **Starting at \$13,400 with A/C, Heat, HD Steps and a Large 300 Gallon Waste Tank**

See our website for more layouts and prices



8' starting at \$13,400  
w/A/C & Heat - 300 gal waste



12' starting at \$21,300  
w/A/C & Heat - 450 gal waste  
*Includes Showers*



20' starting at \$29,900  
w/A/C & Heat - 600 gal waste



24' ADA starting at \$35,600  
w/A/C & Heat - 750 gal waste

INFO@COHSI.COM • 877.382.2935 • WWW.COHSI.COM

## Enviro Waste Oil Recovery

**Mahopac, N.Y.**

Owner Colin Deems is a stickler for details when he orders a new vacuum truck. And this 2004 Kenworth W900 — loaded up with options and comfort features — is no exception. Deems involved driver Michael Deperna in developing specs for the old-school design Kenworth covered, ironically, in a Mack Green and white color scheme. The rig, built out by Presvac Systems, is powered by a Caterpillar C15 550-hp engine with a 13-speed Eaton-Fuller transmission. The powerplant growls through twin vortex breathers and 6-inch exhaust. The work-horse features a two-compartment 4,200-gallon (1,400 gallons front, 2,800 gallons rear) tank with heated pneumatic valves matched to a 750-cfm Fruitland pump. The exterior is dressed up with special-order old-style Kenworth doors with vent windows, quad air horns, green clearance and neon underbody lights, 24-inch aluminum wheels and chrome accents, including air horns, bumpers and stacks. The cab features full leather plush pillow upholstery, rosewood steering wheel, chrome dash gauges and dual air-ride seats. The truck is used to transfer waste oil, clean catch basins and work on spill recovery projects throughout the New York City area.

### Show us yours!

Got a truck with real WOW appeal? Show it off to Pumper readers — and to the whole world through [www.pumper.com](http://www.pumper.com)!

Send photos of your truck after it has been lettered with your company name, and please pose the owner(s) with the truck. Any industry-related truck is acceptable. Please limit your submission to one truck only.

Your submission must include your name, company name, mailing address, phone number, and details about the truck, including tank size, cab/chassis information, pump information, the company that built the truck, and any other details you consider important. In particular, tell us what features of the truck help make your work life more efficient and more profitable. Email your materials to [editor@pumper.com](mailto:editor@pumper.com) or mail to Editor, Pumper, P.O. Box 220, Three Lakes WI 54562. We look forward to hearing from you!



# Brawn and beauty.



Booth 5069



231.830.8099 | [www.fivepeaks.net](http://www.fivepeaks.net)  
866.293.1502

## WE'RE TOUGH. WE'RE ELEGANT. WE'RE JUST RIGHT FOR YOUR JOB OR EVENT.

When one product has everything your company needs, why would you consider going anywhere else? Our units are tough and durable for a construction site, yet designed to a higher standard for your special events. And above all, we're simply affordable!

Our walls and door assembly can take a beating without tearing or dislodging thanks to our exclusive extruded corners. And if your beating becomes too much, we stand behind it by offering a written 10-year warranty!

If blue doesn't work for you, no problem! Our units are available in a variety of standard and custom designer colors. Standard features include an oversized stainless steel mirror, coat hook, shelving with cup holder, hover handle and much more.

So no matter how you use our units, whether at a construction site or at a special event, they're made for you. Contact us today for more information on our complete line of products including Standard, Elite and ADA Compliant Portable Restrooms, Hand Washing Sinks, Deodorizing Products, Trucks, Accessories and Support Products.

Call 866.293.1502 or visit us online at [FivePeaks.net](http://FivePeaks.net).

WAREHOUSE LOCATIONS: California, Colorado, Georgia, Michigan, New Jersey, Texas, Ontario Canada



# FRUITLAND VACUUM PUMPS. SIMPLY THE BEST

**We are the #1 vacuum vane pump servicing the oil fields across North America.**

**The reason is simplicity.**

**We don't need gimmicks or water cooling to serve the harshest of applications.  
Simple uncomplicated design that works.**

## Features:

- Every Pump "Factory Tested"
- Low Maintenance Cost
- Continuous Duty
- Air - Cooled
- No Washboard
- Vacuum to 28 hg.
- Pressure to 30 psi.
- ISO Certified
- 2 Year Factory Warranty
- Automated Lubrication System
- User friendly Maintenance Features
- Models for Tanks sizes from 1000 to 12000 Gallons
- Drive option include; Hydraulic, Direct, Belt, and Right - Angle
- Proven in all environments (sub-zero to 100 degrees plus)



**Booth 8139**

## Markets:

- Industrial •
- Oilfield •
- Septic •
- Grease •
- Environmental •
- Wastewater •

**Used and Proven by  
World's Top Liquid  
Vacuum Service Companies.**

*\*Vacuum Pump Training  
Courses available*

## Fruitland Tool & Manufacturing

**" Committed to Quality, Reliability, and Guaranteed Performance "**

Contact us today: **1-800-663-9003**

Visit us @ [www.fruitland-mfg.com](http://www.fruitland-mfg.com) For more info.

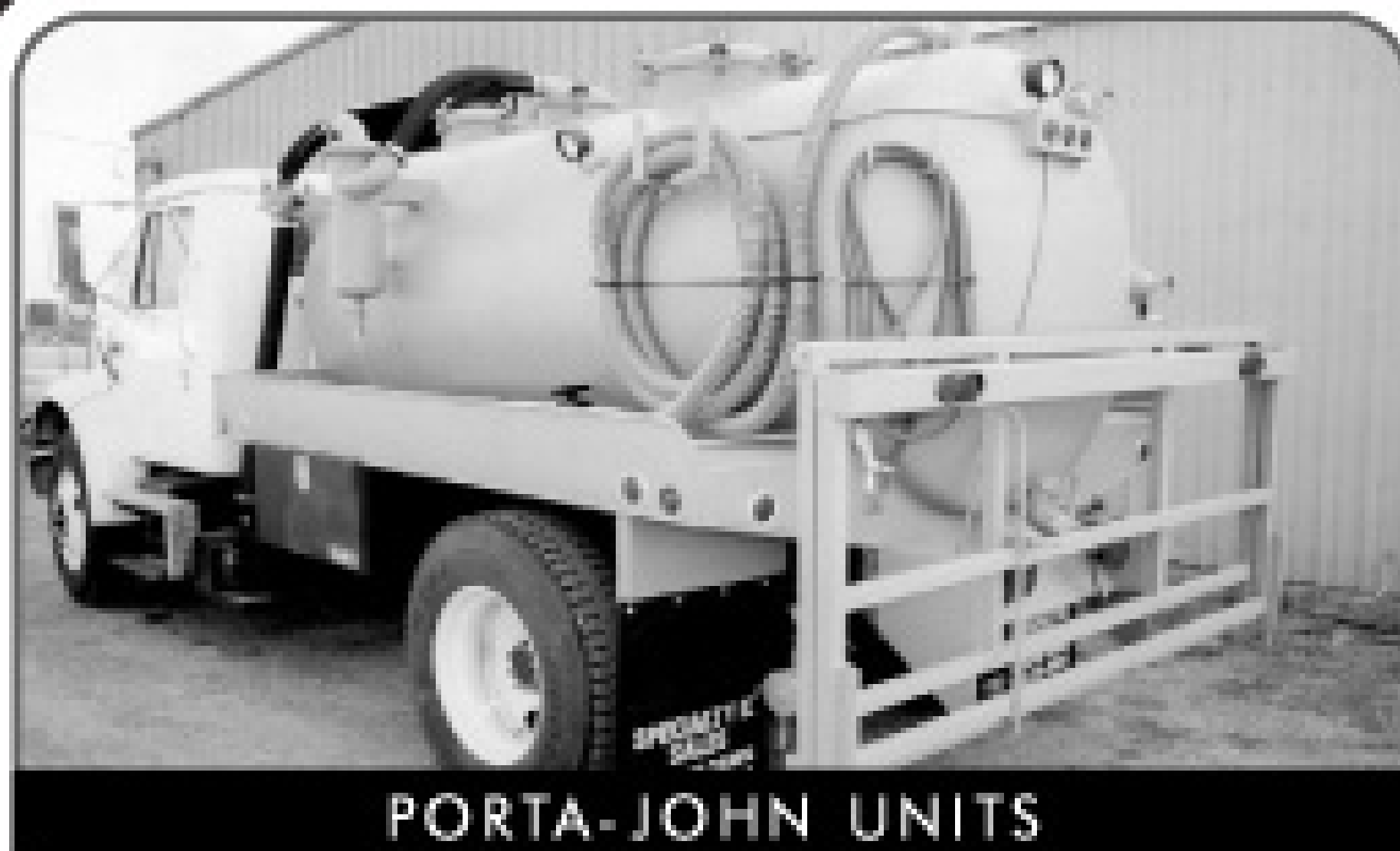

PORTA-JOHN UNITS



STAINLESS STEEL & STEEL UNITS -  
CALL FOR INFORMATION



TANKS MANUFACTURED TO YOUR SPECIFICATIONS

## PUMP DISTRIBUTOR

- \* BATTIONI      \* JUROP
- \* BOWIE         \* MASPORT
- \* FRUITLAND   \* MORO

**Pump Rebuild Kits In Stock**

**CALL TODAY FOR  
INFORMATION  
OR PRICES ON  
TANKS, PUMPS  
AND ALL PARTS**

Secondary Shutoffs

Sight Glasses, Valves & Couplings

12" Primary Shutoffs

21" & 36" Manways



### BASE TANKS INCLUDE:

1/4" Thick Steel • Pipe Reinforced Baffles • Primary Shutoff  
Flanged and Dished Heads • 21" Top and Rear Hatches  
Full Length Under Carriage on Bottom of Tank

### BASE TANK PRICING

2100 GALLON.....	\$5800	3360 GALLON.....	\$8380
2500 GALLON.....	\$6690	3570 GALLON.....	\$8900
3000 GALLON.....	\$7350	4000 GALLON.....	\$9880



**800.364.7307**

2100 EAST BOOTH ST. • SEARCY, AR 72143  
Fax: 501.279.0003 • E-mail: [sbs@cdlworld.net](mailto:sbs@cdlworld.net)

800.334.8237

Visit The Latest  
Innovations In  
Vacuum Technology In



Booth 14039



Toll-Free: **800.334.8237** or E-mail: [info@keithhuber.com](mailto:info@keithhuber.com)



## KING VAC®

THE WORLD'S MOST VERSATILE WET OR DRY VACUUM LOADER. THE KING VAC® COMBINES TWO DIFFERENT LOADING PRINCIPLES IN ONE POWERFUL MACHINE: VACUUM LOADING AS A WET MACHINE AND AIR CONVEYING FOR DRY VACUUM USE.



## DOMINATOR®

THE BACKBONE OF THE VACUUM PUMPING INDUSTRY COMPLETES OUR INDUSTRIAL PRODUCT LINE AS THE BEST CHOICE FOR PUMPING LIQUIDS, SLUDGES AND SEMI-SOLIDS. THIS VACUUM LOADER IS MANY THINGS, BUT ONE THING IT'S NOT... IT'S NOT JUST ANOTHER "WET VAC"



## AIRLORD®

DESIGNED WITH 9 STAGE AIR INVERTING CYCLONE AND INTERNAL MULTI-STAGE PRE-FILTER, THIS ULTIMATE DRY VAC AIR MACHINE BUILT TO SATISFY CUSTOMERS WHO PREFER BAGHOUSE FINAL FILTRATION

**Visit Our Website at [www.keithhuber.com](http://www.keithhuber.com) Or Give Us A Call at 800.334.8237**  
**When you need high performance vacuum equipment, we should get together.**



WHEN YOU REALLY NEED A WORK TRUCK NOW!

**1-800-822-8785**

[www.fssolutionsgroup.com](http://www.fssolutionsgroup.com)



1999 Vactor 2110, 80 GPM, Extendable Boom, Nicely Equipped, Auto Transmission  
**READY TO WORK!**



1998 Clean Earth Safe Vac, 27" Vacuum, Recently Refurbished, New Paint  
**READY TO WORK!**



1997 Guzzler CL, Ford Chassis, Recently Refurbished, New Paint, 18" Vacuum  
**READY TO WORK!**

**Many More Units Available • Call for Details!**

**Parts and Service**  
**Financing for Used Equipment and Service**  
**Warranties for Most Equipment**  
**We Sell and Service**  
**The Largest Selection of Refurbished**  
**Vacuum Trucks in the World**



## Dewatering Equipment



**Use The Right Equipment  
To Get The Best Results.**

Liquid Reduction = Reduced Transportation Costs

Dewatering = Reduced Tipping Fees

Non Organic Separation = Facilitate Land Application of Liquids

**ACCENT**  
MANUFACTURING INC.

*Designed for Simplicity. Engineered for Durability.*

**Toll Free: 877.855.4890**

[info@accentmanufacturing.com](mailto:info@accentmanufacturing.com) • [www.accentmanufacturing.com](http://www.accentmanufacturing.com)



**# 5015 & 6017**

**4000 Gallon  
pumper on a 2007  
M2 Freightliner**  
Tank: Bright finish  
aluminum-5/16" #5454  
shell and heads 76" Dia.

Pumping system: Jurop LC420 water cooled pump  
Chassis: Freightliner M2-54,000 GVW, C-7 Caterpillar 300 H.P., 10  
speed transmission-14,600 front axle-40,000 air ride rear axle.

**2800 Gallon  
pumper on a  
2007 International**

Tank: Bright finish  
aluminum-5/16"  
#5454 shell  
and heads

Pumping system: Massport HXL 15  
(350 CFM)

Chassis: International 4300-33,000 GVW, 245 HP DT466-RDS  
3500-12,000 front axle, 21,000 rear axle.



**WHITE RIVER  
DISTRIBUTORS, INC.**  
BATESVILLE, ARKANSAS

**(800)-548-7219**  
**(870)-793-2374**  
[www.lpgbobbails.com](http://www.lpgbobbails.com)

# SAFE FRESH™

Deodorizers

*Protection That Pays™*



**Scientifically Superior!**



**Online Ordering!**



**Unmatched Rewards!**



Our exclusive ROI Program pays you back with FREE restrooms when you purchase SAFE-T-FRESH Deodorizers. (Special bonus for new customers)

**Unique Triple Action Formula**

**Earn FREE RESTROOMS**

**Order A Custom Blend**

**Expert Advice and Service**

**Express Shipping**



[www.safetfresh.com](http://www.safetfresh.com)

**Place Your Order Online**  
[www.safetfresh.com](http://www.safetfresh.com)  
 Anytime - 24/7  
 Safe and Secure

**For Assistance Call:**  
**877-ROI-PAYS**  
 877-764-7297

SAFE  FRESH™  
 Deodorizers  
*Protection That Pays™*



**Thursday**

**Jeff Foxworthy**  
*After Party*



**6 Nightclubs... 1 City Block!**

  
**BIG CITY**  
**BLOCK**  
**LOUISVILLE**

**February 28th, 29th  
and March 1st, 2008**

**502.589.3866**

**cityblocklouisville.com**

**Friday**

**The CHROME  
SHOP MAFIA  
VIP Party**  
*Party with the MAFIA!*



**Saturday**

# Revolutionary Biodegradable Formula



Booth 2009

## TrueX 70 Series

Our Revolutionary TrueX 70-series uses the most advanced time-released formula to control odors longer than other deodorizers on the market. The unique biocides break down paper and waste while reducing mounding in Portable Restrooms, even in the most extreme conditions.

*Our super concentrated TrueX70 Series is the strongest non-formaldehyde on the market.*

Call our customer service team  
for more details.

**1-800-345-3303**  
**www.jjchem.com**





**MOST POPULAR PUMP**

**JUROP R260 PUMP**

- 363 CFM
- 21 PSI
- 18" CONTINUOUS DUTY
- BALLAST PORT COOLING
- AUTOMATIC OILER

Booth 6191



**JUROP R260 PUMP**

**\$2825.95**

GREAT LOW PRICE!



**EPDM SUCTION HOSE**

MADE IN USA

COUPLED M X F QUICK CONNECT



**BRASS LEVER VALVES**

3" \$112.95

4" \$169.95

6" \$299.95

ALUMINUM MALE X FEMALE REDUCER

3" X 2" \$17.85

4" X 3" \$26.52

6" X 4" \$45.95

100'S OF COUPLERS & REDUCERS!



**HI-VAC SUCTION HOSE**

**CPLD Mx F QUICK CONNECT**

2" X 20' \$74.70

2" X 25' \$91.70

2" X 30' \$108.70

2" X 40' \$142.20



**BRAIDED EPDM HOSE**

3" ID CPLD LENGTHS M X F CAM & GROOVE

3" X 20' \$104.95

3" X 30' \$147.95

3" X 35' \$168.95



3" X 20' \$96.25 **\$79.95**

3" X 25' \$115.75 **\$94.95**

3" X 30' \$134.95 **\$109.95**

3" X 33' \$146.95 **\$119.95**

**VARCO FLEXI-JOINT**

NO MORE BREAKING OFF AT THE TRUCK!

**\$51.99**



**PVC SANDY GRIP GLOVES**

**\$12.95 /DZ**



- Braided Reinforcement
- Abrasion Resistant
- Lighter weight

FABRIC BRAID MAKES IT STRONGER!

2" BUY AND SAVE! 3"

**\$2.50 BULK 100' ROLLS \$4.25**

**BULK EPDM SUCTION HOSE**

LOW PRICES!

2" 3" 4" 6"

\$1.79 \$2.99 \$5.35 \$11.05

**\$1.69 \$2.89 \$5.25 \$10.95**

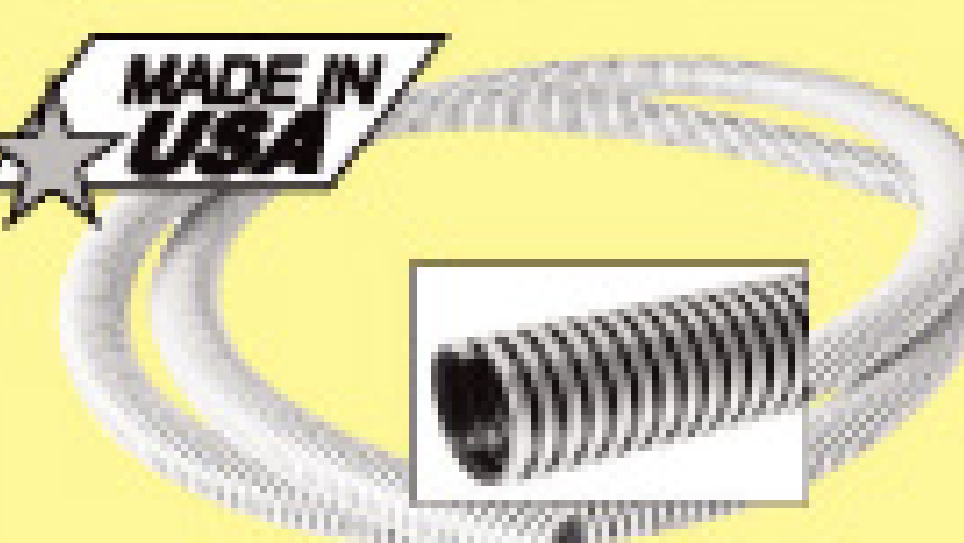

**FREE CATALOG**



**LOW, LOW PRICES - SAME DAY SHIPPING - FAMILY RUN!**

TOLL FREE **866-872-1224**

SOURCE KEY 1P8



**MEGA Holding Tank**

1250 Gallon Size



**Options**

Black Color • Level Alarm • Custom Fittings

**KentuckyTank**

Plastic Tanks and Accessories

**1-888-459-8265**

[www.kentuckytank.com](http://www.kentuckytank.com)

**LOW PROFILE Portable Holding Tank**

100 • 210 • 300 Gallon Sizes



Custom Fitting Locations at No Charge

**On-Site Water System**

**OSW PLUS —**

- Tough 65 gal. Tank
- Removable cover for easy cleaning
- 115V On-Demand Pump 3.5 gpm 45 psi
- Low water shut-off
- GFCI Protected
- Filter
- Ships UPS

**OSW DELUXE —**

- Add external fill connection w/float valve



Easy View Natural Office Grey

**Bulk Storage and Transport Tanks**



**Septic and Cistern Tanks**



**Ball Valves and Cam Lock Couplers**



**NORWESCO**

Distributor Since 1987

Nationwide Shipping Points





# HOUSE OF IMPORTS **TRUCK SALES**

▶▶ SINCE 1947

**CALL ANGEL AT:**  
**786.258.3384**  
**OR**  
**305.691.4778**

▶▶ [WWW.HOUSE-OF-IMPORTS.COM](http://WWW.HOUSE-OF-IMPORTS.COM)

## EXTRA CLEAN USED TRUCKS WITH NEW TANKS!



SEE THESE TRUCKS AT THE PUMPER & CLEANER EXPO IN LOUISVILLE AT BOOTHS 4222,4223,4225

**2004 PETERBILT 379**

**475 H.P. - COMING SOON**

**2005 PETERBILT 379**

**430 H.P. - COMING SOON**

**2004 PETERBILT 379**

**500 H.P. - COMING SOON**



**2002 STERLING**

**THANK YOU TO BRUCE**



**2000 FREIGHTLINER**

**THANKS TO MR. IAN OF KINGSTON, JAMAICA**



**2001 FREIGHTLINER**

**THANK YOU TO MIKE COWPER OF HONOLULU, HAWAII**



**2000 INTERNATIONAL**

**THANK YOU TO MR. & MRS. HARRIS**

**100,000 MILE LIMITED FACTORY WARRANTY**

▶ DELIVERY ▶ EXPORT ▶ PUMP WARRANTY: 1 YEAR ▶ TANK WARRANTY: 5 YEARS





## NAWT at Louisville: Big Opportunities in Education and Certification

**T**he National Association of Wastewater Transporters Inc. is offering its U.S. Environmental Protection Agency-endorsed Inspector Training and Certification Course on Feb.

25-26 during the Pumper & Cleaner Environmental Expo at the Kentucky Exposition Center in Louisville, Ky. Experienced industry professionals or those just starting out in the business will find valuable information on solving daily sewage flow, troubleshooting septic tanks and soil treatment units, evaluating the effects of high-strength waste, using effluent filters, and more. Attendees will also learn how to inspect tanks, pumps, other pretreatment devices and drainfields. Those who complete the program earn a two-year National Inspector Certification issued by NAWT, a listing on the association's National Registry Web site and qualify to take the National Sanitation Foundation Certification Program test.

NAWT is presenting the National Onsite Education and Research Foundation's Vacuum Truck Technician Training and Certification course on Feb. 26.

**THE GOAL IS FOR LEGISLATORS  
TO KNOW THAT YOUR  
ASSOCIATION EXISTS AND COME  
TO IT FOR ADVICE.**

The sessions are for anyone who owns or operates vacuum trucks to clean septic tanks, aerobic treatment units, holding tanks, or grease traps. Some topics include government regulations, the science of vacuum and pressure,

truck equipment and components, drive and control mechanisms, and manifests and reports. Experienced and inexperienced drivers will find the course highly informative and beneficial. To register for either course, call NAWT at 800/236-6298 or download the application form from [www.nawt.org](http://www.nawt.org).

NAWT also has a special track during Education Day at the Pumper & Cleaner Expo on Feb. 27. Subjects are:

- **Responsible Management Entities**, 8 a.m., by A.R. Rubin and William Hasselkuss.
- **Review of ATU Operation & Maintenance**, 9:30 a.m., by Bruce Lesikar, Ph.D.
- **A Visionary Review of the Agricultural Utilization of Septage**, 11 a.m., by Stephen Rohm.

### REGISTRATION FORM

**NAWT Inspection Training & Certification, Louisville, KY • Feb. 25-26, 2008**

**NAWT Vacuum Truck Technician Training, Louisville, KY • Feb. 26, 2008**



Name \_\_\_\_\_ Company \_\_\_\_\_

Address \_\_\_\_\_ City \_\_\_\_\_ State \_\_\_\_\_ ZIP \_\_\_\_\_

E-mail \_\_\_\_\_ Phone \_\_\_\_\_ Fax \_\_\_\_\_

#### Inspection Training & Certification • Feb. 25-26, 2008

- Full Registration Fee:** \$395 Member; \$495 Non-Member  
 **Recertification Fee (Day 1 or 2 Only):** \$295 Member; \$395 Non-Member

#### Vacuum Truck Technician Training • Feb. 26, 2008

- Full Registration Fee:** \$175

**PAYMENT METHOD:**  Check enclosed (Payable to NAWT)  VISA  MasterCard

Card Number: \_\_\_\_\_ Expiration Date: \_\_\_\_\_ Name on Card: \_\_\_\_\_

Signature \_\_\_\_\_

Fax or send your form with payment to the NAWT office by Feb. 15, 2008.  
Pre-registration and pre-payment required.

**NAWT**

**336 Chestnut Lane, Ambler, PA 19002-1001**

Registrations with payment information may be faxed to 267/200-0279. Questions? Call NAWT at 800/236-6298.

- **Why a Municipality Opens a Septage Treatment Facility**, 1 p.m., by Chris Buday (Grand Traverse County Department of Public Works).

- **When is Septage really Septage?** 2:30 p.m., by Tom Frank.

- **How to Survive an EPA Audit**, 4 p.m., by John Coletti (EPA Region 5).

NAWT will announce the winner of the \$1,000 William Hapchuk Memorial Scholarship Fund on Feb. 28. Applicants, only full-time college students by fall 2008, must write a 500-word essay responding to the question: "How can the pumping industry help communities (customers, politicians, and regulators) understand that use and management of onsite systems provide a long-term solution for their sewage disposal needs while helping to strengthen the community?" The deadline to submit essays is Feb. 10. Applications and rules are at [www.nawt.org](http://www.nawt.org), click Scholarship.

NAWT understands that many regulatory accomplishments happen at the state level, and consequently believes firmly in the strength of statewide organizations. Eighteen states have a NAWT director, and all are taking turns staffing Expo booth 20003. Check the roster posted in the booth to talk to your state NAWT director. If you don't have one, NAWT can help you get one.

#### NEW YEAR'S RESOLUTIONS

- **Go to Louisville and learn a lot.** Be the best that you can be with training and education.

- **Develop service contracts.** The Environmental Protection Agency, one of NAWT's Memorandum of Understanding partners, has hired a marketing consultant to help pumpers spread the word to homeowners about maintaining their onsite systems. NAWT has a free download of a sample service contract on its Web site for anyone to use.

- **Be more involved in your state organization.** Participate in writing legislation to improve the septic code. Strong state organizations can put meat in regulations, and become influential enough that lawmakers won't write septic

legislation without consulting them. The goal is for legislators to know that your association exists and come to it for advice.

Check our Web site at [www.nawt.org](http://www.nawt.org) for the latest updates on NAWT training programs, and seminars.

*Tom Ferrero is executive director of the National Association of Wastewater Transporters Inc.*

## Join NAWT Now!

**Independent Member (\$150)**  
**Company Member (\$300)**  
**Associate Member (\$300)**  
**State Association Member (\$100)**

*Be a part of the pride and professionalism  
that all NAWT members enjoy!*

**Contact NAWT today:**

**1-800-236-NAWT (6298) Fax 267-200-0279**

**[www.nawt.org](http://www.nawt.org)**

# OVERLAND TANK, INC.

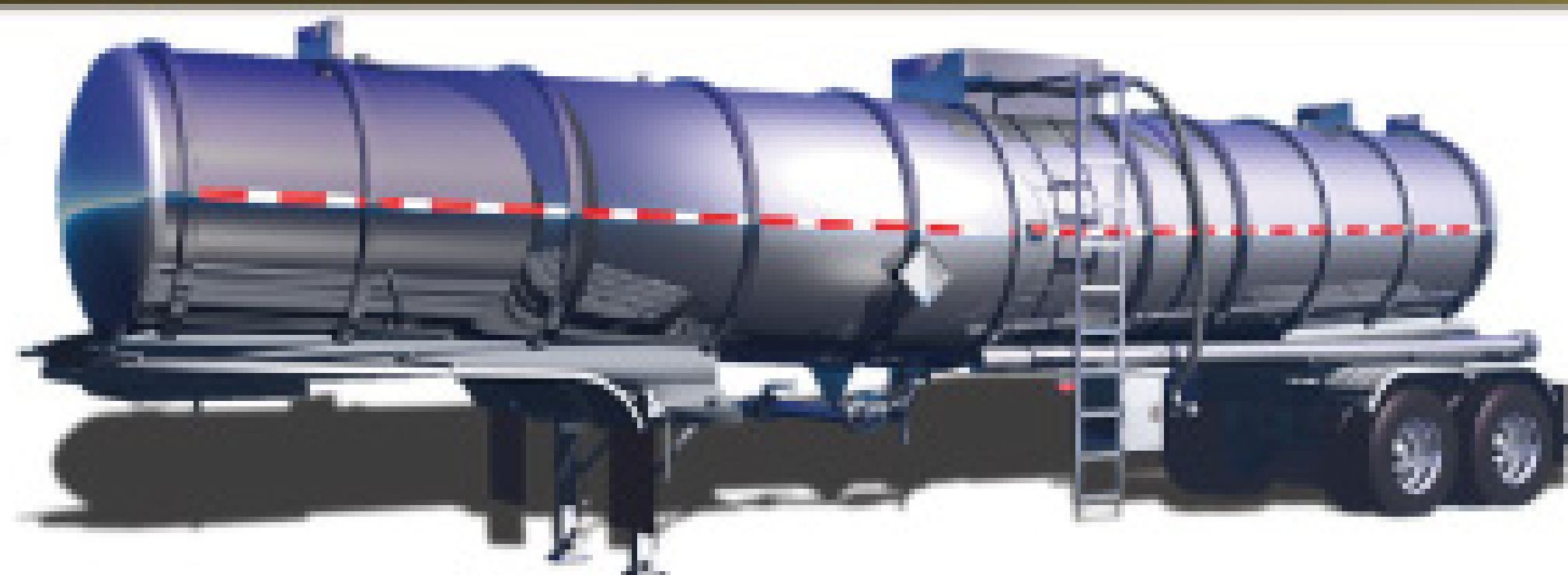

200BBL DOUBLE CONICAL CRUDE OIL TRAILERS

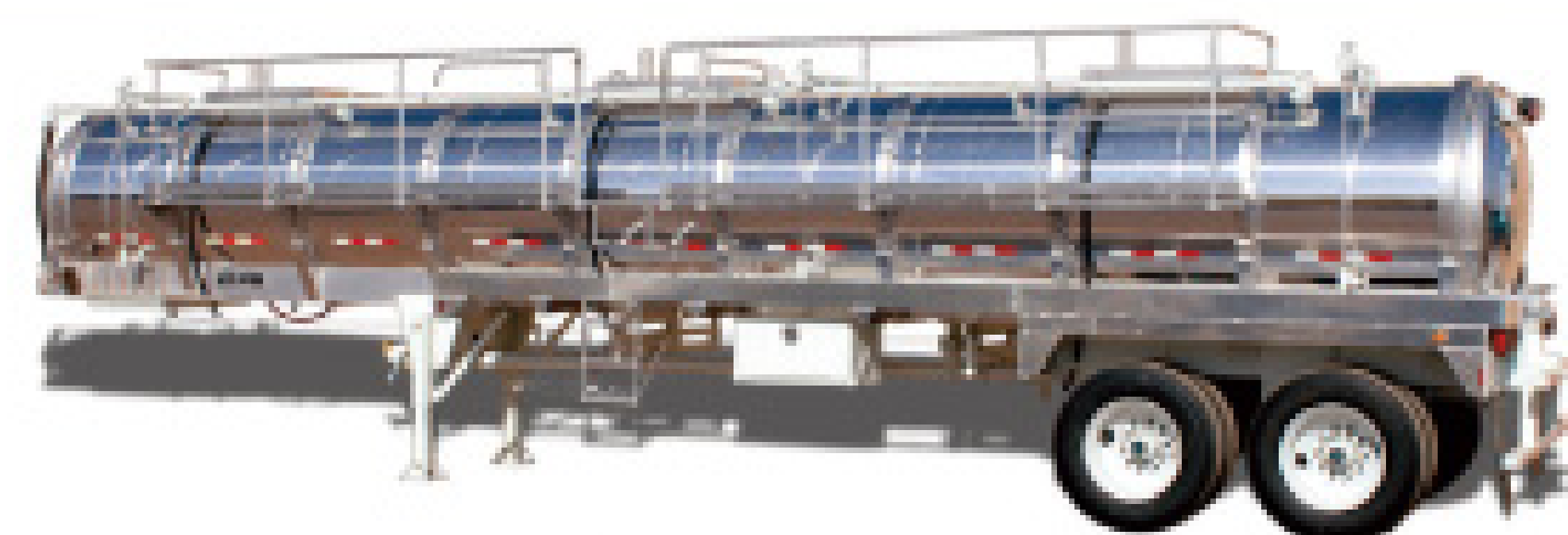

ALUMINUM VACUUM TRAILERS  
ALUMINUM TRANSPORT TRAILERS



TWIN DOT 407/412 ACID TANKS

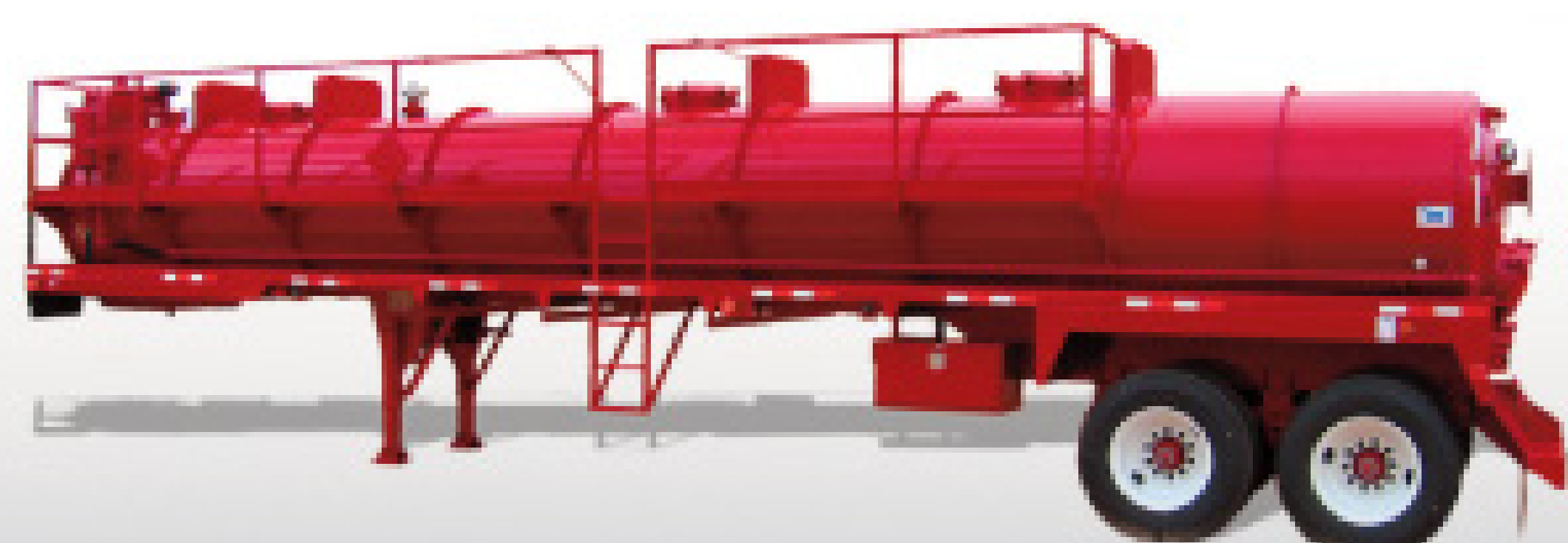

ASME CODE VACUUM TRAILERS



STEEL TRANSPORT/KILL TRAILERS



DOT 407/412 ACID TRAILERS



SEE US IN LOUISVILLE  
RUSH SALES BOOTH

**7222**

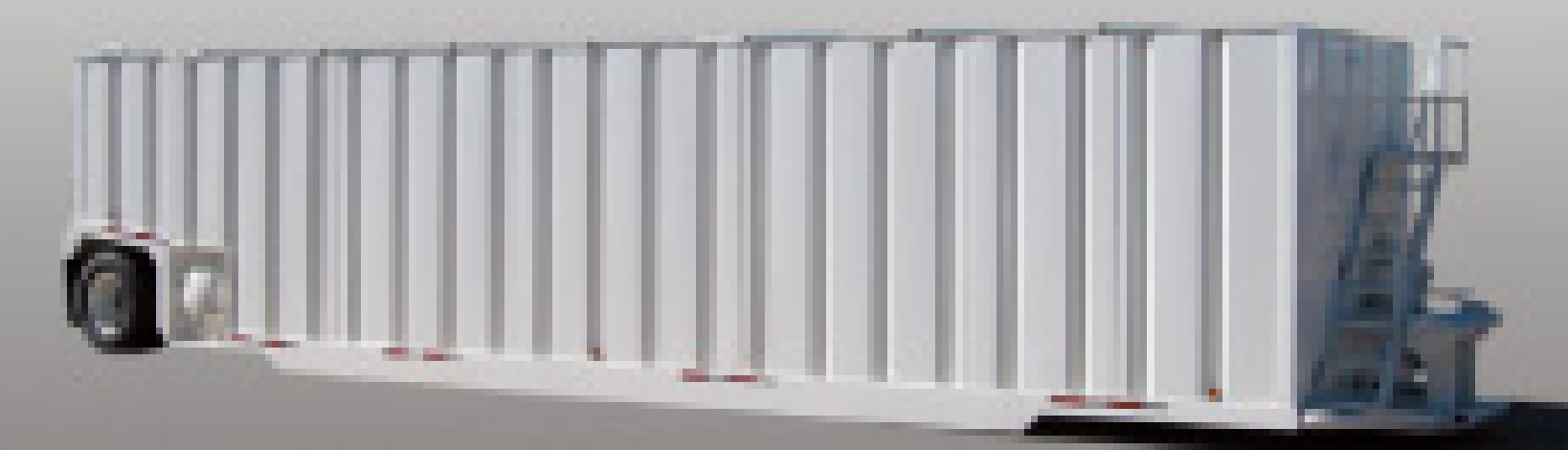

500 BBL PORTABLE FRAC TANK

**4725 FM 18 ABILENE, TEXAS 79602 WWW.OVERLANDTANK.COM TOLL FREE: 866.635.7132**





# Super Products

Worldwide Vacuum Technology - Since 1972



Booth 1054

# Supersucker® with High-Dump Option

- › Rear Lift Height up to 60"
- › Unloads Efficiently
- › Heavy Duty
- › Low Maintenance
- › Easy to Operate



[www.superproductscorp.com](http://www.superproductscorp.com)

800.837.9711

# Wolf Creek Co.

Original Bauer

Portable Piping

Bauer Fittings

Polybarb™ Pipe & Tails

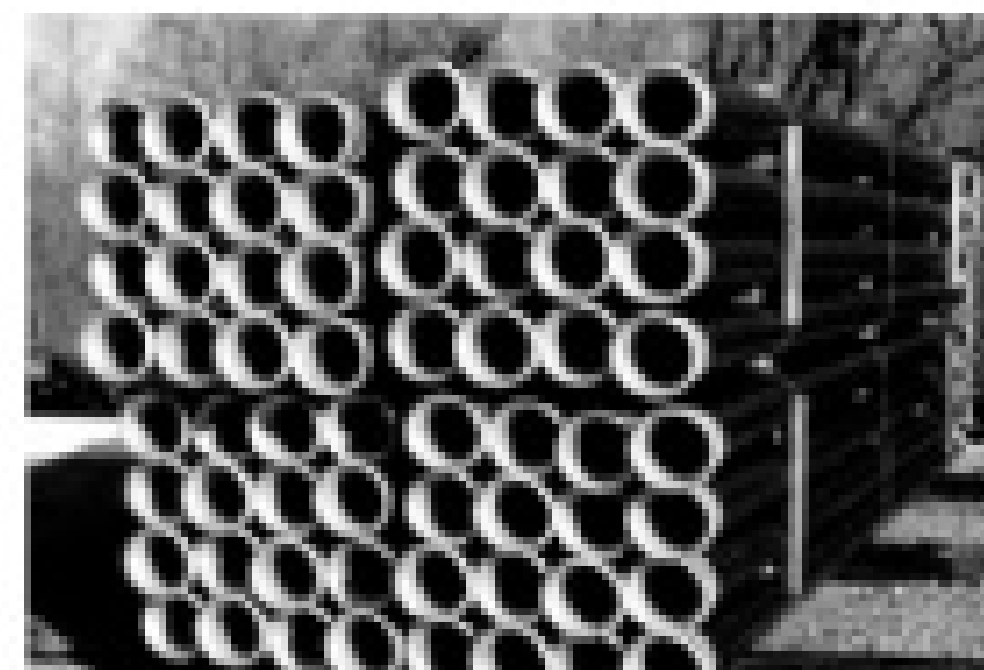

Polybarb™ HDPE pipes and fusible tails available in 4" to 12" diameters up to 40' in length.



Booth 29

Industrial Vac Tubes

Available in weldable, hose insert, and flanged connections. Fittings available from 2" to 12".

Bauer Pipe



Galvanized piping available in 2" to 12"

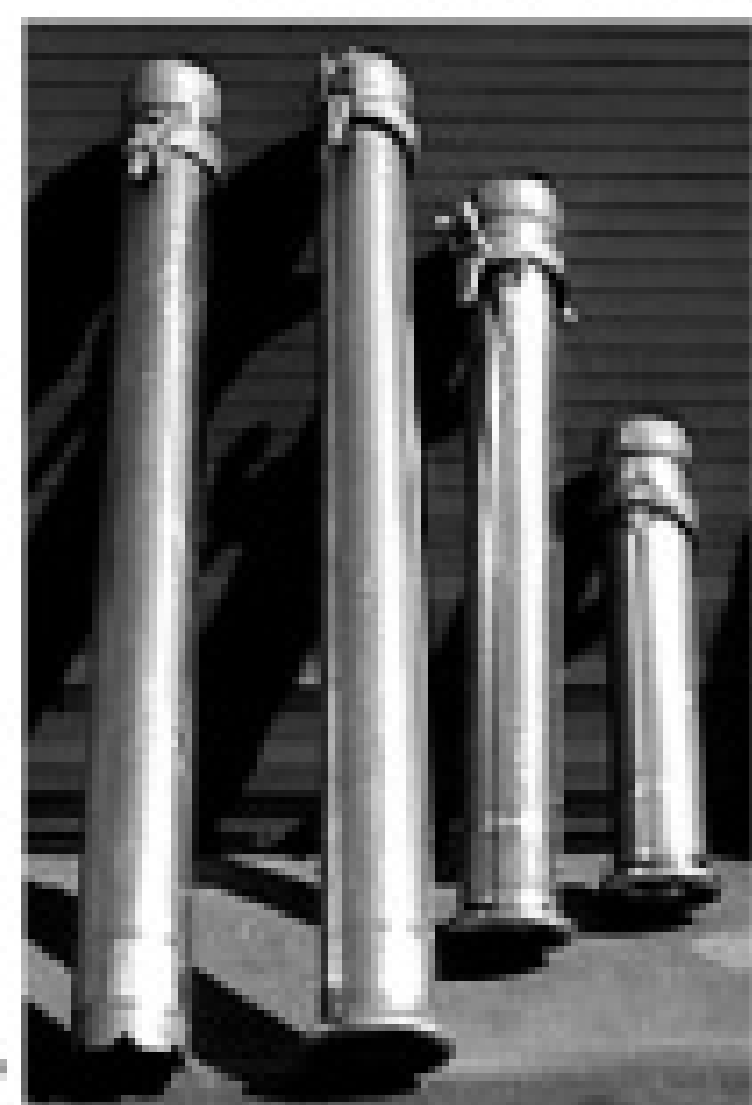

We can fabricate aluminum vacuum evacuation or suction tubes per your specifications. Using the Bauer Coupler or Anfor Coupler.



800.488.7305 • [www.wolfcreekcompany.com](http://www.wolfcreekcompany.com)

Double Conical Vacuum Trailers

# Vacutrax



#7048 & 7049



Improved handling for high sludge volumes

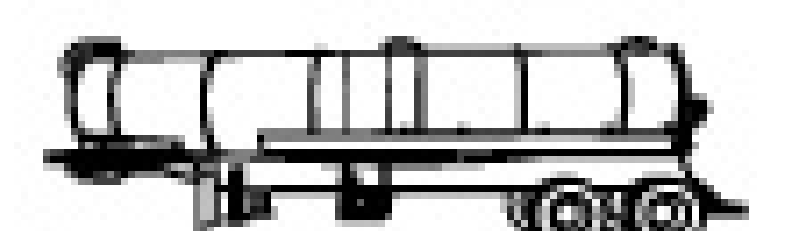
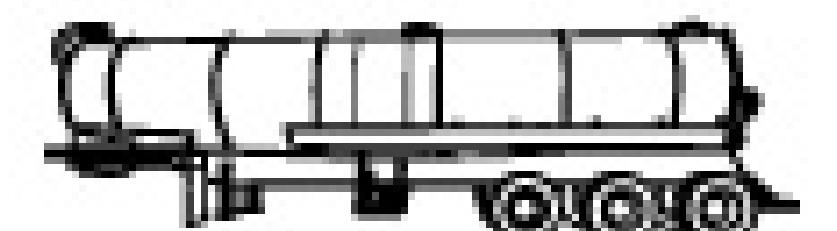
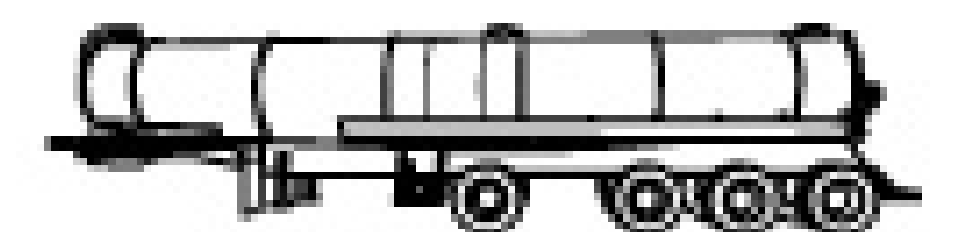

Trailer sized for your requirement. Powerful vacuum pumps. Superior suspension and trailer technology!

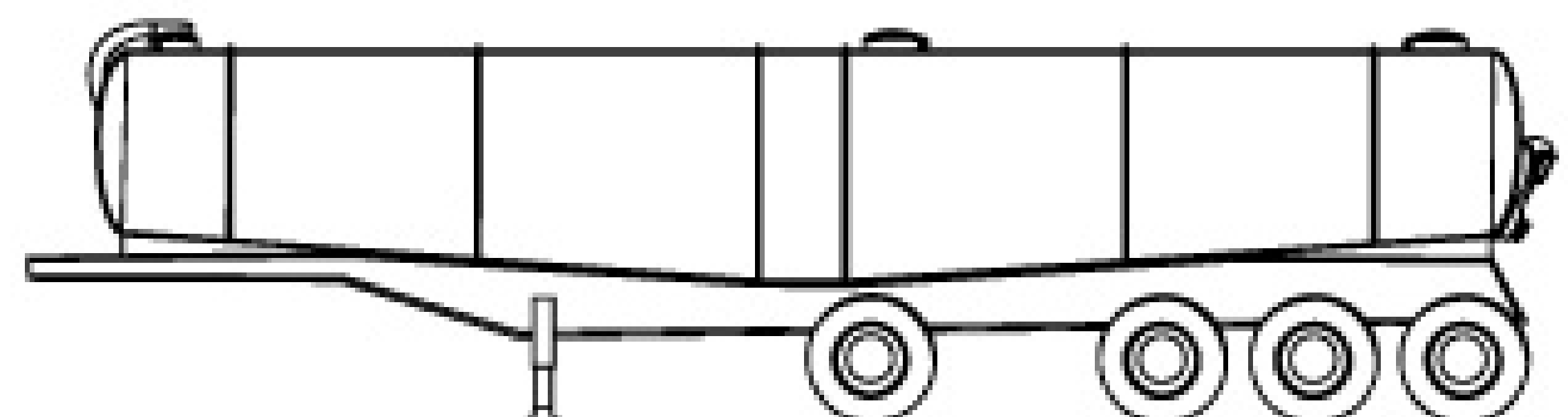

Vacutrax Limited 53 Arthur Street N. Elmira, Ontario, CANADA N3B 2Z7 800-305-4305 Fax:(519) 669-8331

# TRANSPORT TRUCK SALES, INC.

Ask for Scott or Frank – 888-395-7551  
After hours call Scott at 816-590-4076



## What Does It Take To Be A "Qualified Chassis"?

- ✓ Pass our 12 point checklist. (We send this out with every quote!)
- ✓ Pass a D.O.T. certified inspection!
- ✓ Pass the warranty inspection!

## What Does All This Do For You?

- ✓ Nationwide drive train warranty for 2 years/ 200K miles! (restrictions apply)
- ✓ A tough truck that is ready to work as hard as you do!

**YOUR TRADES ARE WELCOME!**

**Searching For A Brand New Chassis?  
We Have Them In Stock!**



IN PROGRESS

**1999 International 9200i**, Detroit 12.7L 430HP, 10-spd, jakes, 291K miles, double framed, AC, new 3360 gal. steel tank, new liquid cooled HXL-400 Masport vac pump.

**Call For Pricing!**

**2-YEAR 200,000 MILE DRIVE TRAIN WARRANTY**



**1998 Mack CH613**, E-7 350HP, 9-spd, A/C, low miles, double frame, new 3360 gal. steel tank, new liquid cooled HXL-400 Masport vac pump.

**Call For Pricing!**

**2-YEAR 200,000 MILE DRIVE TRAIN WARRANTY**



**2002 Sterling AT-9513**, Cat C-12 410HP, 10-spd, 350K miles, double framed, AC, new 3360 gal. steel tank, new liquid cooled HXL-400 Masport vac pump.

**Call For Pricing!**

**2-YEAR 200,000 MILE DRIVE TRAIN WARRANTY**



**2006 International 4300**, DT-466E 215HP, 6-spd, 52K miles, cruise, AC, new 2300 gal. steel tank, new Jurop vac pump.

**Call For Pricing!**

**2-YEAR 100,000 MILE DRIVE TRAIN WARRANTY**



**2002 International 9100i**, Cat C-12 410HP, 10-spd, jakes, double framed, AC, new 3360 gal. steel tank, new liquid cooled HXL-400 Masport vac pump.

**Call For Pricing!**

**2-YEAR 200,000 MILE DRIVE TRAIN WARRANTY**



**1999 Freightliner FL-70**, Cummins 215HP, 6-spd., 33# GVW, air brakes, AC, low miles, new 2300 gal. steel tank, new Jurop vac pump.

**Call For Pricing!**

**2-YEAR 100,000 MILE DRIVE TRAIN WARRANTY**

**Delivery Available Anywhere in the Lower 48!!**



# You Can't Buy A Better Reel.

## Hose Reels for Cleaning and Pumping

- ✓ High pressure washing and cleaning
- ✓ Sewer, septic, portable toilet cleaning
- ✓ Video pipeline inspection
- ✓ OE vehicles and aftermarket upgrades
- ✓ Extra rugged, long-lasting design
- ✓ Complete custom capabilities



Download or call for your FREE Guide to Ordering Pumper/Cleaner Reels  
<http://go.hannay.com/U16>  
**877-467-3357**

 **Hannay Reels®**  
*The reel leader.*

## WANT A TRUCK THAT REALLY SUCKS?



### Vacuum Trucks from Rocket Supply

#### The Amthor Matador Flat Vac

The Amthor Matador Flat Vac offers an exclusive improved tank design available in 5/16" aluminum, 1/4" steel and 1/4" stainless steel with capacities from 500 to 2000 gallons with full internal baffles. This unique body is used to service portable toilets and can carry 8 to 12 at one time, making it a very efficient vehicle. Features a rounded floor that allows for easy product drainage.

#### The Amthor Matador

The Amthor Matador offers an exclusive improved tank design available in 5/16" aluminum, 1/4" steel and 1/4" stainless steel with capacities from 500 to 7000 gallons. With full internal baffling and a heavier side shell than the competition, it allows for the absence of external rings, which provides a smoother looking tank when adding your brand or logo to it. Dumping options are also available.

*For Excellent Price and Fast Delivery!*

**Rocket Supply** *Since 1959*

Contact Us for More Details



Roberts, Illinois • 800-252-6871 • [www.rocketupply.com](http://www.rocketupply.com)



**PRECISION TANK & EQUIPMENT CO.**  
[www.precisiontank.com](http://www.precisiontank.com) | 1.800.258.4197

CENTRAL ILLINOIS Manufacturer Celebrating 40 years of steel and stainless steel tank equipment innovations. Tank sizes from 100 to 5000 gallons in stainless steel or steel.

Manufacturing plants in Virginia and Athens, Illinois bringing quick completion of your pumper truck!

40 years of excellence!

**PRECISION TANK & EQUIPMENT CO.**



*Standard models or custom built units*

*Single or multiple compartments*

**1.800.258.4197**

# Refuse Systems



## Your truck specialists in the solid and liquid waste industries.

If you are in the market for a refuse vehicle, make Rush Refuse Systems your resource. We have one of the largest inventories of work ready trucks in the country, representing the industry's leading brands. Whether you need to buy, rent or lease, we have a full spectrum of financial resources available. And, we support you through our Rush Truck Centers network of over 50 locations — with an extensive parts and accessories inventory, highly skilled ASE-certified service professionals and exceptional body shop capabilities.



### Peterbilt 340 Industrial Vacuum Trucks

Automatics and Standards in stock ready for delivery. DOT 407/412 3150 Gallon Cusco units. Moro PM100 Pump, Hydraulic full opening rear, Vibrator Box, Air actuated valves, Full Walkway with handrail, 20 Ton Dump Capacity Cylinder.



### Peterbilt 340 Standard Vacuum Trucks

Automatics and Standards in Stock ready to go to work. Non Code 3600 Gallon Pik-Rite Tank. Masport HXL400WV Liquid Cooled Pump, Aluminum Hose Trays, Internal Primary to secondary Piping for clean mount. 10 yr Tank Warranty Standard. Options can be added before delivery. Compare our standard Specs to anybody!



### 2007 Peterbilt Model 357 Roll Off

Pre 07 Emission, Cat or Cummins, 8LL Transmission, 20 Fr/ 44-46 Rears, Air Trac or Hendrickson Suspension, 60K or 75K Hoists, Pioneer and O'Brian Tarpers, Mounted or Cab and Chassis Still Available!



Booth 4210



### 2007 and 2008 Peterbilt Cab and Chassis

Whether you're putting an old tank on a new truck, or custom building a truck the way you've always wanted, call us and choose from a wide variety of models and specs on the ground. Fast shipping available to your destination. Tank dealers and manufacturers welcome.

# 877-661-4511

Refuse Sales Team: Gregg Wilkinson | Jason Guzauskas | Jesse Fullilove | Hal Holloway  
refusesales@rush-enterprises.com

8810 IH-10 East | San Antonio, TX 78219



www.rushrefusesystems.com





# BASE ENGINEERING INC.

INDUSTRIAL WIRELESS CONTROLS

## PUMPER TRUCK Radio Remote Controls

4 Year Replacement Warranty  
Life-Time Product Support



**1.800.924.1010**

OEM Dealer Inquiries Welcome

www.baseng.com • sales@baseng.com

Visit us at the Pumper Show Booth 4030

# Pipeline Cleaning & Maintenance Equipment



for



## JETTERS & JET VACS

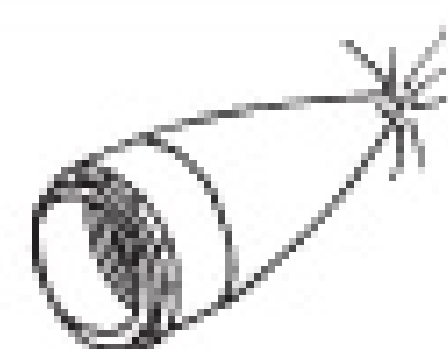

### Penetrators

- 1/4"-15° .....\$31.00
- 3/8"-15° .....\$36.00
- 1/2"-25° .....\$41.00
- 1/2"-25°LT .....\$44.00
- 3/4"-12° .....\$48.00
- 3/4"-12°LT .....\$56.00
- 1"-12° .....\$61.00
- 1"-12°LT .....\$72.00



### Aluminum Grease

3/4" or 1"-17° ...\$105.00

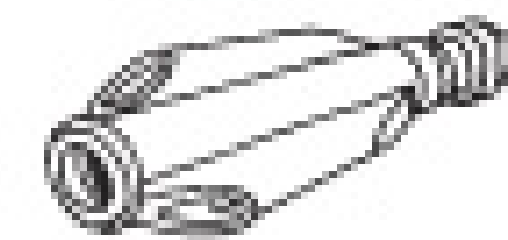

### Truder

1" .....\$315.00

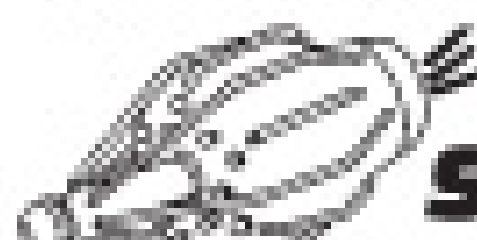

### Shark

1" .....\$435.00  
1" Big Shark.....\$555.00

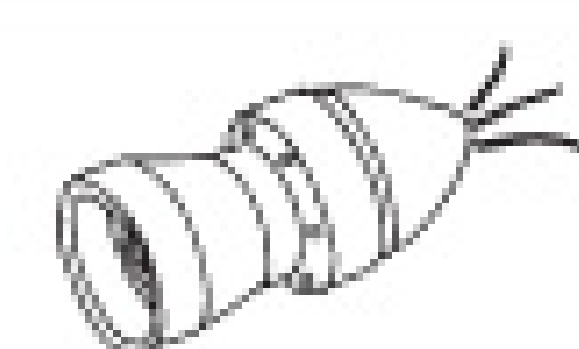

### Radial Bullet

- 1/4"-30° or 40° .....\$18.75
- 3/8"-30° or 40° .....\$21.75
- 3/4"-18° or 35° .....\$44.00
- 3/4"-18°/24° .....\$46.00
- 1"-18° or 30° .....\$59.00
- 1"-15° or 30° .....\$55.00
- 1-1/4"-18 or 35° .....\$85.00

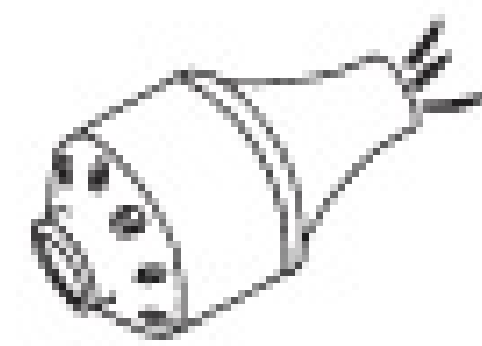

### Aluminum Sand

- 3/4"-24° .....\$125.00
- 1"-17°/24° .....\$138.00
- 1"-24° .....\$125.00

### Stainless Steel Nozzles

- 1/8" .....\$26.00
- 1/4" .....\$28.00
- 3/8" .....\$34.00
- 1/2" .....\$48.00
- 3/4" .....\$52.00
- 1" .....\$92.00

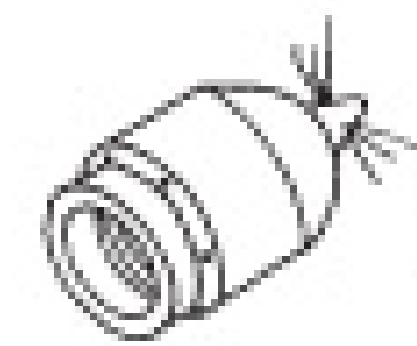

### Steel Sand

1"-12° .....\$59.00

### NEW Storm/Culvert Floor Cleaner Nozzles

## MANY OTHER STYLES, SHAPES & SIZES AVAILABLE



### Root Cutter Assemblies

- Skid Mounted**
- w/flat blades .....\$815.00
- w/concave blades.....\$850.00
- w/spiral blades.....\$850.00
- Donut Mounted**
- w/flat blades .....\$790.00
- w/concave blades.....\$835.00
- w/spiral blades.....\$835.00
- Lateral Mounted**
- w/flat blades .....\$762.00
- w/concave blades.....\$825.00
- Assemblies come with one ea. of 6, 8, 10 and 12" blades, saw blades, hub, skids, etc.

### Sewer Hose Guides

- TigerTail™ Style**
- 3" x 36" .....\$42.00
- 2" x 36" .....\$34.00
- with 24' rope



### Swivel Joints

- T-M® Style**
- 90° or Straight, 6000 psi
- 3/4" & 1" .....\$169.00
- 1-1/4" .....\$174.00
- 1-1/2" .....\$432.00
- 2" .....\$547.00



### Clamps

- Power Clamps**
- 8" .....\$11.00
- 3"-6" available
- King Clamps**
- 8" .....\$24.00
- 4"-6" available
- Bandlock® Clamps**
- 8" .....\$18.00
- 3"-6" available
- Quick Clamps**
- 8" .....\$21.00
- 3"-6" available



- Ball Valves**
- Dyna Quip® Style, Stainless Steel, 3000 psi**
- 1" .....\$145.00
- 1-1/4" .....\$190.00



### Saw Blades

4"-18"

- NEW Chain Root Cutters**
- 4"-48", All Stainless Steel, No Lubrication



### HD Washdown Gun

25 gpm @ 850 psi  
1/2" Inlet .....\$140.00

### Parker & Piranha Jetter Hose

1/8"-1-1/4"

Pipe/Sewer Plugs • Hose Reels • Aluminum Intake Tubes  
Kanaflex™/Rubber Debris Hose • Full Line Of Warthog Nozzles



Booth 176



SARASOTA, FLORIDA • PHONE: 941-739-0707 • FAX: 941-739-0001

**Toll Free: 800-365-6583**  
**www.cloverleaftool.com**

Full Catalog Online with Prices



CALL FOR OUR COMPLETE CATALOG WITH PRICES

# Mid Continent Truck Sales, Inc.

891 Adkins Hill Rd. • Norman, OK 73072 • 405-329-5365 • Fax: 405-329-5381 • After Hours: 405-288-6502 • www.vacuumtrucksales.com

## Trucks - Trailers - Vacuum Tanks - Pumps



2001 IH 4700, DT466E, Allison auto, non-CDL, air brakes, new MEC 6500 vacuum pump, new 1100/400 vacuum tank.



2000 Freightliner, Detroit 60 series (430/470 hp) w/fresh overhaul, 10-speed, double frame, new Wally 753LNHR vac pump, new 3400 gallon vacuum tank.



2004 Kenworth T300, Cat C7 (210 hp), 6-spd., 33K GVW, new Wally 753HR (350 cfm), new 2600 gal. aluminum vacuum tank, 2-yr. nationwide drivetrain warranty.



1998 IH 9100, Cat C10 (370 hp) w/fresh overhaul, 10-speed, double frame, new Wally 753LNHR vacuum pump, new 3400 gallon vacuum tank.



1998 Freightliner FL60, Cummins 5.9 (210 hp), 6-spd., Masport H75V vacuum pump, General 47 series triplex, 1100/200 gallon vacuum tank.



**LET US QUOTE YOUR NEXT VACUUM TANK!**

## MID CONTINENT TRUCK SALES

manufactures and stocks all necessary components to complete your vacuum system.

Whether it's pumps, valves, moisture traps, oil catch mufflers, pump frames, etc.

**CALL US BEFORE YOU BUY!**



Booth 5211, 5213, 6211

**KEPP**  
Pumps  
Since 1946

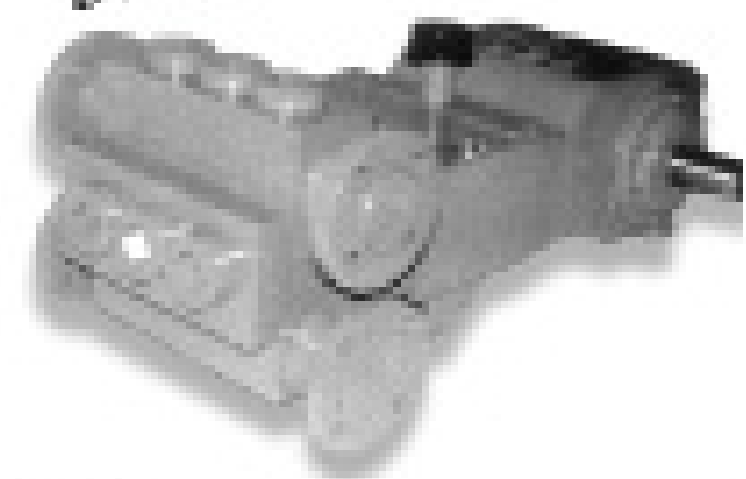

**Masport**

**NVE**

AUTHORIZED DISTRIBUTOR



**vallenstein**  
vacuum pumps

**BOWIE**



FLUID AND SLURRY  
**PUMPS**

WE CARRY MOST BRANDS OF VACUUM PUMPS AND PARTS!



**WE WILL BUILD TOILET UNITS TO YOUR SPECS!**

Call DAVE PERRY for TRUCK quotations and CHUCK RODGERS for TANK quotations.



# JANUARY Pumper CLASSIFIEDS

2008

- ▶ Advertising
- ▶ Aerators
- ▶ Bucket Machines
- ▶ Businesses
- ▶ Business Opportunities
- ▶ Cable Machines
- ▶ Computer Software
- ▶ Dewatering
- ▶ Drainfield Restoration
- ▶ Drain / Sewer Cleaning Equipment
- ▶ Dredges
- ▶ Excavating Equipment
- ▶ Hazardous Waste Units
- ▶ Hydroexcavation
- ▶ Jettors-Trailer
- ▶ Jettors-Truck
- ▶ Jet Vacs
- ▶ Lease Financing
- ▶ Locators
- ▶ Miscellaneous
- ▶ Parts & Components
- ▶ Pipeline Rehabilitation
- ▶ Portable Restrooms
- ▶ Portable Restroom Sinks
- ▶ Portable Restroom Tanks
- ▶ Portable Restroom Trailers
- ▶ Portable Restroom Trucks
- ▶ Positions Available
- ▶ Positions Wanted
- ▶ Positive Displacement Blowers
- ▶ Pressure Washers
- ▶ Pumps-Dredge
- ▶ Pumps-High Pressure
- ▶ Pumps-Submersible
- ▶ Pumps-Vacuum
- ▶ Pumps-Water
- ▶ Rodding Machines
- ▶ Roll-Off Containers
- ▶ Roll-Off Trailers
- ▶ Roll-Off Trucks
- ▶ Root Control
- ▶ Safety Equipment
- ▶ Septic Tank Forms
- ▶ Septic Trucks
- ▶ Service / Repair
- ▶ Slide-In Unit
- ▶ Sludge Applicators
- ▶ Tanks
- ▶ Tools
- ▶ Trailers- Vacuum / Tanker
- ▶ TV Inspection
- ▶ Vacuum Loaders
- ▶ Vanes
- ▶ Vehicle Tracking
- ▶ Wanted
- ▶ Wastewater Transfer
- ▶ Waterblasting

## AERATORS

**TERRALIFT 2000:** 2002 model year, 228 hours, excellent condition. \$22,500. 574-256-1465. (P1)

## ADVERTISING

**REMINDER POSTCARDS:** Advertise full color postcards of your truck, service or products. Great marketing tool. Visit [www.postcardprinting.com](http://www.postcardprinting.com). Toll Free 1-888-334-4553. (PBM)

## BUSINESSES

**FOR SALE:** Septic and Portable Toilet Business located in Holland, Michigan. 10 toilets, 2 sinks, 1 truck. \$5,000 buys all! For more info. call 616-548-5128 or email me: [smscamaro75@yahoo.com](mailto:smscamaro75@yahoo.com). (PT3)

Established pumping, plumbing, and roter company for sale. 50+ yrs. of business. Established in the San Joaquin Valley in sunny Calif. Pumping truck 2,200 gal., service truck with all tools required to continue service as it is going now. Portable jetting machine, locators for steel, plastic and clay lines. Established commercial contracts and a complete base of customers for three counties. Company has been grossing over \$400K and with ambition will go higher. Drain lines installed, city hook-ups, much, more, more. All parts, many extras, everything in shop for business to go. \$190,000. Serious calls. 559-636-3112. (P1)

Port-a-potty business for sale. Trucks, trailers, 175+ port-a-potties, large a/c restroom trailer. In SD. Call Jim, Broker/Owner Aesoph Real Estate. 605-880-9129. (P1)

**FOR SALE:** Northern New Jersey septic installation and pumping business. Company grosses average \$400K/yr. 2001 Sterling 2800 gal. pumper, 2 excavators, dump truck, low boy tractor trailer, 2004 Mitsubishi box/utility truck stocked with all tools and fuel tank. Work already in pipe-stream. Loyal client base and excellent referrals. Owner relocating. Any reasonable offer considered. Serious offers only please! Call 973-332-5374 for details. (P2)

## BUSINESSES

No dump fees, no yard cost = low overhead. 3-year-old Cal. company with military contracts and great books, turn key, operating and ready for new owner. (1) 2007 4x4 F550 pumper, (1) 1993 4x4 F350 pumper, low miles, 2 delivery trailers, 120 like new Satellite Johns, 6 double hand stations for sale. 33% of annual gross. \$145,000. Please serious and qualified only. 760-367-7734. (P1)

**FOR SALE:** 20-YEAR ESTABLISHED PORTABLE TOILET BUSINESS IN WV. ± 350 Tuff Johns, ± 50 Satellites, some fiberglass, 6-8 holding tanks (mobile office), 4 toilet hauling trailers: 2006 F550 w/100 gal. water, 250 gal. waste; 2005 F550 w/250 gal. water, 500 gal. waste; 1985 Mack pumper w/jetter, 2500 gal. waste, 1000 gal. water. 250-300 toilets on rental now. Gross \$350,000 yearly or more. Call 304-472-7962 for Tammy. (P3)

**FOR SALE:** Septic and Portable Toilet Business located in White Mountains, Arizona. 150 toilets, 2 ADAs, 3 trucks. For more info call 928-368-7834. (PBM)

**BUSINESSES WANTED:** Septic pumping, grease trap, drain cleaning and other ancillary businesses wanted. We are buying well run businesses in New England, Mid-Atlantic and Florida. All opportunities will be given proper consideration. Confidentiality ensured. Will move quickly for the right opportunity. Serious inquiries only. Please contact Richard Bedard @ 617-336-3344 or [rbedard@bwseptic.com](mailto:rbedard@bwseptic.com). (PBM)

Well-established portable restroom business for sale in Massachusetts. Locally owned and operated for ten years with excellent customer base. Annual sales over 1 Million. Seven service trucks with 1600-2000 gal. tanks; one 10 toilet delivery truck; three delivery trailers; two 8000 gal. tank trailers; one Ford L9000 tractor. Over 1000 portable toilets plus Flushable, Handicaps, Hand-washing Stations, VIP and Holding Tanks. 60% of inventory rented. Serious inquiries to [toilets26@comcast.net](mailto:toilets26@comcast.net). (PT2)

## BUSINESSES

SEPTIC PUMPING, INSTALLATION AND POTTYHOUSE BUSINESS: Central Illinois. Established 12 years, 2,000+ customer base. Great for father/son or husband/wife. Most work in 30-mile radius. \$115,000. OR buy name, phone number and customer files for \$100,000. OR buy into corporation for \$50,000, will train and get you licensed; and you complete the buy-out one year from buy-in. 217-417-0374. (CP2)

Long Island, New York: For Sale: Cesspool, Septic, Sewer and Drain Cleaning Company For Sale. 2 pump trucks, 2 porta-pottie trucks (service and delivery). Quality workmanship, has established 3000+ loyal customer base. Great opportunity for right person. Jump in on busy season! Money maker! Debt free! Office/shop/yard also available. Call for more information. 631-472-0677. (PBM)

For Sale in Sunny Central Florida: Owner is retiring, excellent septic and grease trap service company with installations of septic systems, grease traps, lift stations, complete pumping and related services offered. Very profitable operation. Must be financially qualified. \$800,000 with \$250,000 down. Seller will finance balance over 7 years for qualified buyer. Steady and recession proof company. Please call 352-653-5377 for more information. (P1)

## BUSINESS OPPORTUNITIES

NORTHEAST OHIO. Looking to acquire Septic/Jetting company. Expanding to Ohio. Please send letter to: Attn: Purchasing, P.O. Box 4834, Mooresville, NC 28117. (P1)

**National Grease Recycling Inc.** Let us teach you how to recycle restaurant's waste fryer grease and oil (yellow grease) only. **No trap grease.** Big \$. Over 30 yrs. experience. Will guide you through complete process from collection to processing to marketing to end users. Don't lose your trap business to competitors that offer both services. Call for information. Dewey Walker. 813-752-9535 or 813-758-2552. (PBM)

## BUSINESS OPPORTUNITIES

**WWW.ROOTERMAN.COM.** Franchises available with low flat fee. New concept. Visit web site or call 1-800-700-8062 x26. (CPBM)

**Attention PolyJohn Owners:** Receive a free CD-Rom of our products to use in your company marketing efforts. Ask your PolyJohn business coach in your area to send you this material today. 1-800-292-1305 Kell. (PBM)

## COMPUTER SOFTWARE

Pumper Plus Billing Software: Regularly \$795. Mention this ad in Pumper.com and purchase for only \$595. Pumper Plus is a billing software package from Galaxy Systems, [www.galsys.com/pumperdemo.asp](http://www.galsys.com/pumperdemo.asp), that handles billing for septic pumping and portable toilet service-type companies. Inquire at [solutions@galsys.com](mailto:solutions@galsys.com) or call 800-985-3029. (PBM)

## DEWATERING

30-yard Spectrum Turbo Dewatering Container with fixed 19 x 18 mesh polyester media and tarp. Used once for demo. Asking: \$24,000. Also, MIXMATE, M102-525-3 Polymer feed system with ALLDOS, 221-8 polymer emulsion pump on 2 wheel dolly, and stainless injector for 3-inch pipe. Eliminates need for a big tank and mixer when performing polymer dewatering. Asking \$2,000. FOB Oklahoma. Call 405-250-9322. (P1)

30 yard, 7,000 gal. capacity grease or septic dewatering box, 2 meter stainless belt press, 2 polymer system. Excellent condition. Can email pictures. Call Oregon 503-577-7223. (P2)

Buy - sell - trade - lease: Filter presses, belt presses, vacuum filters, filter cloth, dewatering bags, tanks, mixers and more! Call Waste Treatment Equipment Specialties at 440-808-8844. **www.wescoequip.com.** (PBM)

PLACE YOUR AD ONLINE AT [www.pumper.com](http://www.pumper.com) - IT'S ALWAYS THERE TO MEET YOUR BUSY SCHEDULE

## DEWATERING

2002 16' MAXIMIZER. Like new, used for two summers. \$30,000 OBO. 937-746-6361. Ask for Scott. (P3)

Two 40-yd. dewatering boxes and one polymer mixing and pumping units with Seepex sludge pumps. 5 years old. Excellent condition. Asking \$20,000/box and \$25,000/pumping unit. Call 1-506-672-2100. (PBM)

## DRAINFIELD RESTORATION

**DO YOU OWN A TERRALIFT MACHINE?** Do you need help with machine operation or sales and marketing programs? We also have the beads. Over eleven years in the business. Toll Free 1-888-252-1006. (P2)

**TERRALIFT:** 2001 Terralift, 6 foot probe, 450 hours. Runs like new. \$15,500. 336-362-3574 anytime. (P2)

## DRAIN/SEWER CLEANING EQUIPMENT

LIKE NEW JETTER (Cam Spray), 4,000 psi, 7 gpm, 24 hp, 12.5 hrs. with 250' 1/2" cleaning hose and additional 300', electric reel, Root Rat nozzle. \$13,500. Call Horacio 661-478-2947. (P2)

## GREASE UNIT

1996 International 4700 cab and chassis with a 1,000 gallon, 2-compartment (1200 waste/600 water) c/s vacuum pressure tank with jetting system. (Stock #2362V) **www.VacuumSalesInc.com, (888) VAC-UNIT (822-8648).** (PBM)

## HAZARDOUS WASTE UNITS

2007 Sterling LT9500 with a new Presvac 3,500 gallon c/s DOT certified 407/412 vacuum tank dump type with full open rear door. Presvac PVB750 vacuum pressure pump (Stock #13294A). **www.VacuumSalesInc.com, (888) VAC-UNIT (822-8648).** (PBM)

1994 Mack with a 4,400 gallon 2 compartment DOT certified unit. (Stock #5371C) **www.VacuumSalesInc.com, (888) VAC-UNIT (822-8648).** (PBM)

## HAZARDOUS WASTE UNITS

2008 Peterbilt 340 with a new Presvac 3200 gallon (US), C/S, DOT certified, full open rear door, dump-style unit. (Stock #13306 A&B) *In production.* **www.VacuumSalesInc.com, (888) VAC-UNIT (822-8648).** (PBM)

2001 Freightliner C120 can and chassis with a new Presvac 3,200 gallon DOT 407/412 certified vacuum pressure tank. (Stock #13329V) **www.VacuumSalesInc.com, (888) VAC-UNIT (822-8648).** (PBM)

ATTENTION: Fleet of Mack vacuum, emergency response service trucks for sale/trade by owner. Tanks and misc. pumping equipment. 417-619-5111. (PBM)

New Presvac 5,500 gallon, C/S, DOT, vacuum tank trailer. (Stock #13325) **www.VacuumSalesInc.com, (888) VAC-UNIT (822-8648).** (PBM)

## JETTERS-TRAILER

2001 Spartan model 798 high pressure jet, 4000 psi, only 142 hours, very good condition. \$17,500. 330-539-6823. (CP2)

American Water Blaster Model WBD90. Delivers 10 gpm @ 10,000 psi. Detroit diesel 353 with Rockford PTO and stainless steel FE-85 Triplex mounted on a trailer. Well maintained, very good working condition. Asking \$14,000. Call 231-218-5398 with questions or e-mail roe@magnumsolvent.com. (CP2)

## JETTERS-TRUCK

2003 Sterling LT7501 with a VacCon Model VPD4216LHA/ 1300 combination vacuum jetter unit. (Stock #4648C) **www.VacuumSalesInc.com, (888) VAC-UNIT (822-8648).** (PBM)

2000 US Jett 10K and 4K, 600 gallon tank, 100 hp Deutz with 747 hrs. Mounted in 14' heated box on a 2000 Chevy 6500, 45K, Cat dsl. Excellent condition. \$70K. 641-673-9377 or 641-660-6991. (CP1)

New PipeHunter Model 38T44 jetting unit, trailer mounted unit, w/335 Poly water tank, 4,000 psi @ 25 gpm, 600' of hose and attachments. **IN STOCK!!! www.VacuumSalesInc.com, (888) VAC-UNIT (822-8648).** (PBM)

## JETTERS-TRUCK

1997 Sreco HV 2000 truck jet, 65 gpm, 2000 psi water pump, 1500 gallon aluminum water tank. Was a city owned unit. Located in Dallas. 972-938-1905. **www.empireequip.com.** (CPBM)

2006 Chevy C5500 with a Pipehunter with a Jet Eye camera and vacuum system. (Stock #13234) **www.VacuumSalesInc.com, (888) VAC-UNIT (822-8648).** (PBM)

Vactor water jet on a 1998 Ford F-800, Cummins diesel, 17,338 miles, automatic, 1000 gallon water tank. Needs water pump. This truck is like new. 972-938-1905. **www.empireequip.com.** (CPBM)

## JET VACS

1978 Ford F800: Model 800F Vactor, 15 cy debris tank, 1,000+ gal. water, good pumps, motors, 69,596 miles, 1,260 hrs. Best offer. Call Jim @ 419-243-5108 Email: jimk@edkellysons.com. (CP1)

1995 Safe-jet on a Ford L8000 chassis, automatic, tandem axle, Meyers 60 gpm pump, 2000 psi, 600' new 1" hose, articulating reel, 1000 gal. water tank, 5-yd. debris box, telescoping boom, 6' vacuum hydro-excavator tube, chain root cutter with skid plates, 91,427 mi. \$47,000. msubola@yahoo.com, 608-241-2382. (P1C2)

2006 2103 Vactor mounted on 2007 Sterling Acterra 4x2, auto, combo sewer cleaner, 500 gal. water tanks, 3.5 yd. debris tanks, PD blower, hydraulic pump 40 GPM @ 2500 PSI, 500' hose reel, 6" tubes, brand new condition, 11,000 miles. No CDL necessary. \$134,000. 561-718-2736. (CP3)

2000 Aquatech B-15 on a Sterling L9513, PD blower, 65 gpm, 2000 psi pump, rear hose reel, 1500 gallon water tanks, 15 yard debris tank. Was a city owned unit. Located in Dallas. 972-938-1905. **www.empireequip.com.** (CPBM)

1995 Vac-Con, reconditioned by Vac-con 2 years ago, 12-yard debris, 1500 gallon water, 80 gpm water pressure, 2000 psi, 74000 miles, runs good. \$64,000. 845-374-1161. (CPBM)

Jack Doheny Supplies Inc. offers a full range of late model combo units and DOT industrial vacuum loaders. Call us @ 1-800-3DOHENY. (CPBM)

## JET VACS

2001 Camel 200/10-yd. Ejector on Sterling LT7501. CAT 3126B, Allison MD3560, Myers 65 gpm/2000 psi, Dresser PD624. 120,000 miles. Well maintained. \$132,500. Call Eddie at 404-361-2738. (P2C3)

1998-2002 Vactors: 2100 single & tandem axle, PD & fan units available. Authorized OEM dealer. Call Joe @ 312-208-6373. Ask us about our Sreco & Seca Jetter that we have in stock! (CP1)

1999 Vac-Con, 12 cubic yard on International, factory rebuilt engine 2005, running complete, 63,436 miles, 80 gpm, 2000 psi, PD, Spicer trans., articulating hose reel. \$98,000. 610-692-9160. (CPBM)

1998 VacCon V312THA on a Ford LT8000, 3-stage fan, 65 gpm, 2000 psi pump, extendible boom, articulating hose reel, 12 yard debris tank, new paint. Was a city owned unit. Located in Dallas. 972-938-1905. **www.empireequip.com.** (CPBM)

(2) 1991 Ford L8000 trucks with Vactor model 2100 sewer/rodder/vacuum systems. 60,000 gw, 7.8 Ford diesel and Allison 750 auto. trans. on Hend susp. 4,782 and 5,490 hours. 94,000 and 102,000 miles. Owned by city of El Paso, TX. Very nice cond. \$40,000 each. 260-478-6418. (P1)

1998 Vactor 2110 on a Freightliner FL80, 28,213 miles, 2-stage fan, 80 gpm, 2,000 psi pump off system accumulator. Was a city owned unit. Located in Dallas. 972-938-1905. **www.empireequip.com.** (CPBM)

1997 Ford Vac & Dig Model VND-S3 with air compressor, pressure washer, F series chassis, GVWR 33,000#. Price \$45,000. Call 503-969-9557 or 503-682-2723. (P1)

2002 VacCon V390LHA on a Sterling L7501, articulating hose reel, 10' extendible boom, 3-stage fan, pump-off system, 65 gpm, 3000 psi pump, new paint, excellent condition. Located in Dallas. 972-938-1905. **www.empireequip.com.** (CPBM)

Vac-Con model VPD4209THA on a 1997 Ford, **PD blower**, 4200 cfm, articulating hose reel, extendible boom, new white paint. Was a city owned unit. In excellent condition. 972-938-1905. **www.empireequip.com.** (CPBM)

## JET VACS

WANTED: Vactor 1200 or 2100 parts. FOR SALE: UEMSI tractor camera. Best offer. Call 1-207-764-9336. (P1)

Low hours, 1995 Vac-Con, 12-yd. debris, new water pump, newly rebuilt Roots blower, auto. trans., AC, tank vibrator, privately owned. \$65,000. 1-800-930-1123 or 954-981-2133. (CPBM)

## LEASE/ FINANCING

**North Star Commercial Credit:** Commercial Loans for Trucks or Equipment. Flexible purchase programs to fit your budget. 21 yrs. in the industry. Contact **Tom Myers - 877-804-2274.** (CPBM)

**Capital Partners:** "Your One Stop Financing Partner" We have 31 years experience specializing in the liquid waste industry. Lease or loan options available on ANY new or used equipment. Contact Jim Stekl at 866-769-2345. (PT2C3)

**BSM Financial Group** is a nationally recognized finance company. We offer flexible payment schedules for all types of equipment new or used. Trucks, pumps, jettors, portable toilets, and software easily financed. We do first time start-ups, established businesses, and challenged credit. **Call Brett at 877-524-7972 or email brett@bsmfinancialgroup.com.** (PBM)

EQUIPMENT FINANCING WITHOUT ALL THE HEADACHES. \*Our specialty is credit scores as low as 600; \*Application only up to \$250,000; \*Start-ups and young businesses up to \$130,000; \*Any type or any make equipment new or used. Let us show you the money. We are in our 20th year. Call toll free at 866-259-5370. BSG Services LLC. (P3)

## MISCELLANEOUS

**Top quality aerators at wholesale prices.** We have replacement units for most name brands and also carry Linear Regenerative Rotary Vane pumps. Flagg Air, Gast, Thomas, FPZ, Secoh, Medo and more. Call a company that understands aerators and aeration systems. Septic Services Inc. 800-536-5564. (CPBM)

BUY IT - SELL IT - PLACE IT - **www.pumper.com** - AVAILABLE ANYTIME, ANYWHERE, ANY DAY



## PARTS & COMPONENTS

Cota transmission for single stage fan. Complete with bell housing and clutch. \$700. 714-639-8352.

(CPBM)

## PORTABLE RESTROOMS

100 PolyJohn PJ3s, construction grade, \$175-\$200 each. 12 PolyJohn We'll Care's, \$400 each. NY location. Call 800-275-3616. (P1)

HI-RISE PORTABLE TOILETS: 8 available. Used in elevators. Good condition. \$380 each. Call 888-463-7687. (PT1)

**PORTABLE RESTROOMS:** Used PolyJohn Fleet unit portable toilets. Brown in color. Good condition. \$150 each. Volume discounts. Call John at 352-266-4036 or email john@floridaexpress.us. (P3)

FOR SALE: 200 plus PolyJohn portable toilets. Job site ready. 100 aqua; 100 tan. 281-351-5921 or 281-541-7448. Houston. (P2)

FOR SALE: Used portable toilets: Polysans, Hightechs models in Northern Ohio. \$100 to \$200 each. 419-466-1349. (PT5)

FOR SALE: PORTABLE TOILETS: 500+ PolyJohn standard tan units; 500+ PolyPortable standard tan units; poly skids, white tops & corners. Good to very good, excellent condition. Save 50-60% off cost new. Quantity order discounts. Call Bob Sartor in Fla. at 352-796-4540. For serious buyer, can arrange shipping. (PTBM)

**Portable Toilets:** Poly constructed, molded seat, urinal, latching door. Handicap accessible units available. New and used. CCI/Brian Touey 805-896-3777. (PBM)

100 Five Peaks units less than 4 months old, colors blue and orange. 30 dark green PolyPortables around 7 months old. 20 4-yr.-old tan PolyJohns. Prices vary on all units based on condition. Located in SE Nebraska. Call 402-217-1118. (P1)

Over 600 PolyJohn units 1-2 years old. Starting at \$300 each. Minimum purchase of 26 units. 772-562-4604. kim@reliablepolyjohn.com. (PBM)

## PORTABLE RESTROOM SINKS

(4) PolyJohn 2-person sinks, (27) PolyJohn 4-person sinks. All have soap dispensers and paper dispensers. Ready to go on a job site or festival grounds. All must go. \$250 each. 989-746-0009. (P3)

## PORTABLE RESTROOM TANKS

500 gallon waste only tank. Ready to use. Battioni pump w/8 hp Kohler, steel tank. \$6,000. N.E. Texas. 903-455-3220. (P2)

Single or multiple compartment tanks. Choose mild, stainless, or galvanized steel. Capacities from 100 to 6000 gallons, any diameter. Parts and accessories to build your own and save money. 800-545-0174. www.tanksandpumps.com. (PBM)

## PORTABLE RESTROOM TRAILERS

**Restroom Trailer - Gold Series:** 32', new and used. Women's - 5 stalls, 2 sinks. Men's - 2 stalls, 2 urinals, 2 sinks. CCI/Brian Touey 805-896-3777. (PBM)

RESTROOM TRAILERS FOR SALE: New in 2007. Various sizes available. Ready for immediate use. 410-266-7812 or go to www.restroomtrailers.org for pictures and details. (P4)

**Restroom Trailer - Platinum Series:** 30', new and used. Women's - 4 stalls, 2 sinks. Men's - 2 stalls, 3 urinals, 2 sinks. CCI/Brian Touey 805-896-3777. (PBM)

2006 Wells Cargo Comfort Elite III, 2 years old, used for special events. \$15,990. In good shape. 504-838-0358. (PT1)

New and used **RESTROOM TRAILERS** available immediately. 8 to 34 foot luxury trailers. Comforts of Home Services Inc. 877-382-2935. (PBM)

(31) Used restroom trailers, some need repair. Great winter project! Located in Portland, OR. Send e-mail for photos and details. These trailers will be sold cheap and quick! E-mail sanipot@comcast.net or call Bruce Phillips at 503-519-6959. (PT3)

Olympic Executive Series and Luxury Liners, 20', 26', and 30'. Located in NY. Call 866-883-9538. (P1)

## PORTABLE RESTROOM TRUCKS

2001 International 4900 Series. White portable toilet pick-up, delivery and service unit. 12 ft., 18 rear, Masport system, hyd. brakes, P/S, A/C, 10' deck with hydraulic lift gate. Unit carries 4 toilets. 38,000 miles. Excellent condition. \$28,500 OBO. 352-796-4540. (PTBM)

1998 International 4700 with a 1,500 US gallon, 2-compartment (1100/400 split), carbon steel, portable toilet service unit. (Stock #8734V) **www.VacuumSalesInc.com, (888) VAC-UNIT (822-8648).** (PBM)

FOR SALE: 2005 Lanes portable restroom truck, C-5500 Chevrolet, 1000 waste, 250 fresh, Conde pump, fresh water pump. \$40,000. Please call 608-742-2648. (P2)

1999 F550 Satellite MD950 service truck, under 5,000 miles on Jasper rebuilt power stroke, Conde Super 6 vacuum pump, 4.5 hp pressure washer, Teel pump fresh water delivery system, hauls 2 units, 4-way valve, garage kept, pics available, \$21,000. 2001 F550 Satellite service truck, 210,000 miles, power stroke, A/C, Conde Super 6 vacuum pump, 6 hp pressure washer, hauls 2 units, Teel pump fresh water delivery system, 4-way valve, garage kept, pics available, \$20,000. 1997 F450 Satellite MD850 service truck, 225,000 miles, power stroke, Masport vacuum pump, Teel pump fresh water delivery system, 4-way valve, garage kept, pics available, \$9,000. Purchase the 2001 or the 1999 and for an additional \$7,500 you can purchase the 1997. 815-877-9770. (P1)

1999 Freightliner FL60 with a 1000 waste, 250 mix, 250 water, stainless steel, portable toilet service unit. (Stock #2104V) **www.VacuumSalesInc.com, (888) VAC-UNIT (822-8648).** (PBM)

**2007 International 4100** (pre-emissions) with a new **Crescent Rectangular Vacuum Tank Model 1100** (750/350). Carry 8 units, Masport pump and traps. **Available now!** View our website [www.crescent-tank.com](http://www.crescent-tank.com) **Crescent Tank Mfg.** 585-657-4104. (P1)

2007 Chevy C7500 cab & chassis with a new 1500 waste, 500 water, aluminum portable. Call for pricing. (Stock #13289) **www.VacuumSalesInc.com, (888) VAC-UNIT (822-8648).** (PBM)

## PORTABLE RESTROOM TRUCKS

1997 Ford F-350, automatic, diesel, flatbed with liftgate, 228,500 miles, 150 waste, 100 fresh, can carry 5 units. \$11,500. 800-219-8911. (PT1)

**2007 GMC 5500** (pre-emissions) with a new **Crescent Rectangular Vacuum Tank Model 1100** (750/350). Carry 8 units, Masport pump and traps. **Available now!** View our website [www.crescent-tank.com](http://www.crescent-tank.com) **Crescent Tank Mfg.** 585-657-4104. (P1)

2001 4700 International, 25500 GVW, engine DT466, 7-spd./OD, A/C, air brakes, 3-compartment tank (450/850/200), M-10 Moro vacuum pump, spot lights, pressurized water spray down & fill, restroom carrier. Pictures [www.acoinc.com/classified](http://www.acoinc.com/classified). Located Salt Lake City, \$38,000. 208-362-3193. (P1)

1994 International 4900 Series. White, DT466, 6-speed, A/C, P/S, A/B, 11R22.5 tires, 12 ft., 21 rear, Masport pump system, 1600 gal. sewage, 500 water, hose reel, (2) unit HD rack, 382,000 miles. Good standby/ spare service unit. Average condition. \$18,500 OBO. 352-796-4540. (PTBM)

**Hino, Isuzu, Peterbilt** now available and waiting to be up-fitted with a **Crescent Rectangular Vacuum Tank**. Carry multiple units, reduce fuel costs and improve productivity. View our website [www.crescent-tank.com](http://www.crescent-tank.com). **Crescent Tank Mfg.** 585-657-4104. (P1)

2004 GMC 5500 with a 1,000 US gallon, 2-compartment (700/300 split), carbon steel, portable toilet service unit. (Stock #0226V) **www.VacuumSalesInc.com, (888) VAC-UNIT (822-8648).** (PBM)

1996 International 4900 Series. White, DT466, 6-speed, A/C, P/S, A/B, 11R22.5 tires, 12 ft., 21 rear, Masport pump system, 1600 gal. sewage, 500 water, hose reel, (2) unit HD rack, 250,000 miles. Solid front-line unit. Very good condition. \$22,500 OBO. 352-796-4540. (PTBM)

(2) 2005 335 Peterbilts, none CDL, 40,000 miles, like new, auto, air, 1500 waste/500 water with pressure washer, Progress tank, 2-unit carrier. \$68,000 each. 608-835-3459. (PBM)

## PORTABLE RESTROOM TRUCKS

1999 Isuzu FTR, 190 hp, 6 cyl. diesel, 25,900 GVW, new Allison auto with 2-yr. warranty, Jay's Inc. 1,300 gallon 800/500 split, National 190 cfm vac. pump, Burks DC-10 wash down pump, heated dump valve, heated bucket fill, heated water pump, 60' hose reel, 2-unit toilet carrier, and more. 123,800 miles. \$35,000. Call Dale 708-878-4391. Located in Illinois. (PBM)

**2002 International Pumper Truck:** 4700 series, DT466, automatic, air brakes, 1200 gallon waste, 300 gallon fresh water, Masport 75 pump. CCI/Brian Touey 805-896-3777. (PBM)

2006 C5500 Chevrolet, miles in 40s with aluminum and steel tanks. Still under warranty. Slide-ins 600/250, \$9,000. Portable toilet transport trailers: 8, 10, 12, 14, 16, 20 haulers. New portable toilet trucks and new and used septic trucks. We stand behind everything we sell. Lane's Vacuum Tank Inc. 1-800-592-3308. (PBM)

## POSITIONS AVAILABLE

Plumbers, drain cleaners, pump truck drivers, come live in beautiful Colorado and earn \$50K to \$100K to do it. We need you. Call me, Jeff 970-618-4828. (CP1)

Market leading sewer manufacturer seeks experienced regional sales manager to manage multi-state territory; excellent base pay, commission, company vehicle and benefits; extensive travel; prefer candidates with experience in business management, general mechanical background, working knowledge of Word/Excel/Powerpoint; fax resume to 773-913-2247. (CMP1)

Plumbing company in Florida seeking enthusiastic class B CDL tanker endorsement licensed pump/vac truck operator. Experience preferred. Medical 401K, holidays, vacations. 1-800-930-1123 or 954-981-2133. (CPBM)

SBP, Inc., a Northwest Florida-based company, is seeking qualified personnel willing to travel. If you are experienced in cured-in-place pipe lining, high pressure cleaning and video and/or manhole or lift station rehabilitation using epoxy lining systems, fax your resume to 850-478-4507 to the attention of Wanda Murphy. (P1)

PLACE YOUR AD ONLINE AT [www.pumper.com](http://www.pumper.com) - IT'S ALWAYS THERE TO MEET YOUR BUSY SCHEDULE

## POSITIONS AVAILABLE

Looking to relocate to Sunny South Florida? Are you an experienced plumber or sewer and drain professional? Then you deserve to earn \$80K/year, \$5,200 bonus and a new truck and full benefits. Please call Don at 1-800-930-1123 or 954-981-2133. (CPBM)

## PUMPS-SUBMERSIBLE

Wholesaler for Hydromatic, Zoeller, Myers, Liberty and ABS pumps. We also supply Grinder pumps and basins. Will help you size them. Septic Services Inc. 800-536-5564. (CPBM)

## PUMPS-VACUUM

1 Battioni WPT 600/P liquid cooled vacuum pump, 385 cfm, on pallet. \$1,000. Good working condition. 608-676-5961. Clinton, WI. (P1)

Complete line of Moro, Conde and engine-driven, stand-alone pump systems, DC10 washdown pump. Call us for any of your vacuum truck parts from shut-off valves, primary and secondary valves, hoses, vacuum pumps and drive systems. Septic Services Inc. 800-536-5564. (CPBM)

New **Masport** pumps and genuine **Masport** components. Compare our price before you buy. W-K Machine & Supply Co. Call 1-800-633-8947. Distributor. (PBM)

Fruitland Tool RCF250, used for septic pumping, never has been rebuilt, extra set of vanes. \$1,100 plus shipping. 518-369-0255 (P1)

Vacuum Pumps – New, used, or rebuilt. 30 to 900 cfm. All major brands; air, water, or fan cooled. Rebuild specialists - rebuilt PB, M3, M10, and others available. 800-545-0174. [www.tanksandpumps.com](http://www.tanksandpumps.com). (PBM)

Need a vacuum pump for your portable pumper? Try our new 30 cfm, 12 volt system. Less noise, no fuel. Automatic oiling, cheaper than a gas engine. 800-545-0174. [www.tanksandpumps.com](http://www.tanksandpumps.com). (PBM)

## SEPTIC SYSTEM COMPONENTS

**TERRALIFT 2000:** 2002 model year, 228 hours, excellent condition. \$22,500. 574-256-1465. (P1)

## SEPTIC TRUCKS

Are you looking for a good used pump truck from 500 to 4000 gallons ranging from \$5,000 to \$37,000? Call Jerry at 918-381-9072. (P3)

1994 Kenworth W900, 4500 gal., 425 Cat, 10-spd., 460 pump with 4500 gal. quad axle pup, \$65,000. 1999 FL-80, 3300 gal., 285 hp Cummins, 360 pump, \$45,000. Both daily drivers and good condition. Dan 296-420-1939. (P2)

(2) 2500 gallon septic trucks: 1999 Int., 33,000 GVW, 6-spd., air brakes, Abernethy tanks, heated valves, Masport pump, tool boxes, work lights, 180,000 miles, used daily, very good condition, garage kept. 419-466-1349 Ohio. (P1)

1994 Ford LTLA 9000, 52 GVW tandem, Detroit diesel 350 hp, locking differential, engine brake. 2600 gallon tank and 400 cfm liquid cooled pump both 2 years old. New clutch. \$37,500. Colorado 719-748-3721. (P2)

1997 Mack, 550,000 miles, 8-spd., 350 hp, new rubber, 3,000 gal. vessel, Masport pump, ready to go. \$61,500. 785-654-3366. (P1)

1994 Western Star pump truck with 4000 gallon tank, Cummings diesel 400 hp, runs good. \$25,000 OBO. Call 716-937-7640. (P1)

1997 Ford with a Presvac 5,000 gallon c/s tank. (Stock #0282C) [www.VacuumSalesInc.com](http://www.VacuumSalesInc.com), (888) VAC-UNIT (822-8648). (PBM)

1994 Freightliner, 3176 Cat engine, 10-speed, 260 Jurup vacuum pump, two-year-old 3,500 gallon tank, heated valves, \$42,000 OBO. Call for pictures. 920-743-8801. (P2)

2001 Intl. DT-466, 7-spd. tandem, new 3600 gal. tank, Masport 350 cfm vacuum pump, 237,000 miles, \$49,000. 2000 Intl., DT-466, auto., new 2300 gal. tank, 350 cfm Masport pump, 147,000 miles, \$44,000. Other new & used toilet & septic trucks available. Everything we sell has warranty. Lane's Vacuum Tank Inc. 1-800-592-3308. (PBM)

2007 Peterbilt 340 with a new Presvac 3600 gallon (US) aluminum vacuum tank unit. (4) 2008 Models Coming Soon. (Stock #13297A). [www.VacuumSalesInc.com](http://www.VacuumSalesInc.com), (888) VAC-UNIT (822-8648). (PBM)

## SEPTIC TRUCKS

1980 International, 9 liter diesel, 5-speed w/2-speed rear, 2,000 gallon tank, Utile pump, \$7,500. Located in NY. Call 800-275-3616. (P1)

1985 Ford F-8000 pump truck, 2500 gallon, Battioni pump, 3208 CAT engine, Eaton transmission. \$12,000. 386-566-2277. (P3)

1994 FL 70 Freightliner, 1620 gal. full door dump, new Masport water cooled pump, new tires, new brakes, Excellent condition. One owner. 605-286-3359. (P1)

2001 Ford F-750, 2,000 gal. steel tank, 3" intake valves, 6" discharge, newer Battioni pump. Needs engine rebuilt & clutch. 7.3 Intl. powerstroke. \$12,000 OBO. 231-679-1234 Mich. (P2)

Pre-owned Coleman tank (tank only), 3,500 gallon, c/s vacuum pressure tank. (Stock #VS102V) [www.VacuumSalesInc.com](http://www.VacuumSalesInc.com), (888) VAC-UNIT (822-8648). (PBM)

1995 IH 4900 DT466, 6-speed, 2150 gal. waste, 120 gal. fresh. 7 years old, 360 National pump, 247,000 miles. Call 814-669-4175. (P1)

1998 Ford with a Cusco 5,000 gallon c/s vacuum tank. (Stock #7300C) [www.VacuumSalesInc.com](http://www.VacuumSalesInc.com), (888) VAC-UNIT (822-8648). (PBM)

2006 Sterling Acterra, Mercedes-Benz powered, has 22,000 miles. Direct drive pump R260. Price: \$56,420. 850-682-4021. (P1)

Pre-owned Presvac tank (tank only), 3,500 gallon, c/s vacuum-pressure tank. (Stock #VSIT01V) [www.VacuumSalesInc.com](http://www.VacuumSalesInc.com), (888) VAC-UNIT (822-8648). (PBM)

2007 new Acro trailer, new Acro 7,000 US gallon aluminum vacuum pressure tank. (Stock #13273 A&B) [www.VacuumSalesInc.com](http://www.VacuumSalesInc.com), (888) VAC-UNIT (822-8648). (PBM)

513 with a Cusco, 5,000 US gallons, carbon steel, vacuum-pressure tank. (Stock #9284V) [www.VacuumSalesInc.com](http://www.VacuumSalesInc.com), (888) VAC-UNIT (822-8648). (PBM)

Need a tank and truck, any size, any make truck? Let us help you get the best deal. Custom built to your specs. For information and a price quote call 800-545-0174. [www.tanksandpumps.com](http://www.tanksandpumps.com). (PBM)

## SERVICE & REPAIR

WANTED TO PURCHASE: Onsite wastewater/septic business in California, preferably one with experience in aerated wastewater treatment. Call 650-631-6674 or e-mail [patrick@nobskatech.com](mailto:patrick@nobskatech.com). (P11)

## SHOWER TRAILER

**Shower Trailer - Gold Series:** 32', new and used. Men and women sides each have 3 private shower stalls with changing area, 1 restroom stall, 1 sink. CCI/Brian Touey 805-896-3777. (PBM)

## SLIDE-IN UNITS

2 BEST ENTERPRISE STAINLESS STEEL SLIDE-IN UNITS. 360 waste/140 fresh, Conde 6 HD vac/pres with Honda 5.5 hp electric start; 600 waste only, Conde 6 HD vac/pres with Honda 5.5 hp electric start. Also, spare Conde 6 HD pump rebuilt and Honda 5.5 hp electric start. 785-292-4933. Frankfort, KS. (P1)

**Start up/Back up** – Complete package; '07 Slide-in unit (250/200), '07 Dodge 2500 4x4. Slide-in unit has a Masport pump with a Honda electric start 5 hp engine. The '07 Dodge has a HO Cummins diesel engine with a 6 speed transmission. See pictures on website [www.crescent-tank.com](http://www.crescent-tank.com). **Crescent Tank Mfg.** 585-657-4104. (P1)

500 gal. slide-in, W350/150F, 5.5 Honda electric start, 75 cfm, Masport pump. Ready to go. \$6,500. 785-654-3366. (P1)

## SLUDGE APPLICATORS

1989 Ag-Chem Terra Gator 2505. 12,560 hours, rebuilt 903 Cummins and Fuller 10-spd. 3,500 hours ago. New u-joints, fuel pump, hydraulic motor, pres/vac pump, and hydraulic cylinders. 4,000 gallon tank, no toolbar, tires 80%. Call 765-572-2844. (PM1)

Agco Terra Model #2004 Gator sludge applicator. Rebuilt engine this year. Has injectors in rear located in Ohio. Call 412-403-4027. (P2)

1987 I.M.E. Super/Jector 3500 gal. vac/pressure tank, 250 hrs. on 3208 Cat re-man. motor. Pearson PB8 vac pump, four-knife shank, tires 66x43.00/25 at about 60%. Unit in good condition. \$45,000. Day: 810-560-3268; Evening: 634-878-5228. (PBM)

## TANKS

1,000 gal. compact portable vac. tank, 700W/300F, 75 cfm or larger pump, Honda 6.5 electric start. Ready to go. \$9,500. 785-654-3366. (P1)

Vacuum tanks, 100 to 6000 gallons. All options available; hatches, primary, secondary, valves, catwalks, ladders, etc. Every-thing needed to build your own septic truck. Choose mild, stainless, or galvanized steel. Ask about full open doors. 800-545-0174. [www.tanksandpumps.com](http://www.tanksandpumps.com). (PBM)

New 2500 gallon tank, 66" x 14", 36" manway bottom, 21" manway top, primary, 3" intake, 4" dump, hose trays w/hose racks, epoxy primered. Ready to set on your truck. \$8,000. New 3500 gallon tank, never used, 36" manways, upper & lower, 3" intake, 4" dump, epoxy primered. \$10,000. Delivery available. Other tanks available. 800-721-2774. (P1)

Hello, I'm Troy Penney and I worked for Bill Roberts at Northwest Truck and Trailer Sales in Abilene, Texas. Bill passed away a year ago and I have opened my own company. If you are in the market for a new or used vacuum tank, give me a call. 325-928-0013 or my cell 325-928-0013. (P1)

2500 gal. Coleman vacuum pressure tank. 14.5' long x 70" wide, 2 baffles, lights, 2" site tube, good condition. \$2,800. 845-863-6080. (P1)

## TANK TRAILER

New Presvac 5,500 gallon, C/S, DOT, vacuum tank trailer. (Stock #13325) [www.VacuumSalesInc.com](http://www.VacuumSalesInc.com), (888) VAC-UNIT (822-8648). (PBM)

2007 new Acro trailer, new Acro 7,000 US gallon aluminum vacuum pressure tank. (Stock #13273A&B) [www.VacuumSalesInc.com](http://www.VacuumSalesInc.com), (888) VAC-UNIT (822-8648). (PBM)

## TOOLS

**T&T Tools:** Probes, Hooks. Probes feature steel shafts with threaded and hardened tips. The insulated **Mighty Probe™** tested to 50,000 volts. **Top Poppers™** open manhole covers easily. Free catalog. [www.TandTtools.com](http://www.TandTtools.com). Phone 800-521-6893. (CPBM)

BUY IT – SELL IT – PLACE IT – [www.pumper.com](http://www.pumper.com) – AVAILABLE ANYTIME, ANYWHERE, ANY DAY



# Extreme Makeover IHI Style



Booth 8209

- 12 Models - 2 Styles
- Zero Tail Swing & Conventional Style
- Operating Weights 2,060 to 18,100 lbs.
- Digging Depths from 5'2" to 15'1"
- Control Pattern Change Valve Standard
- Multi-Function Hydraulic System



400 Production Court, Elizabethtown, KY 42701

800-538-1447

[www.ihcompactexcavator.com](http://www.ihcompactexcavator.com)

## TOOLS

**Crust Busters** - Portable, light-weight machine guaranteed to mix up septic tanks and grease traps! Save time and money! [www.crustbusters.com](http://www.crustbusters.com), 1-888-878-2296. (PBM)

## TOYS

Septic pumper and vacuum die-cast toy trucks in your choice of colors and logos. Several cabs available. Call 877-450-2100 or write to Granite State Collectibles, PO Box 440, New Ipswich, NH 03071. (PBM)

## TRAILERS VACUUM/TANKER

Vacron 2000, Model PMD 800, GT trailer, low hours 270. \$18,500 FOB Minn. 612-328-4054. (P1)

IF YOU ARE USING AN  
**800 NUMBER**

IN YOUR AD, BE SURE IT CAN BE USED  
IN ALL AREAS NATIONWIDE.

## TRUCKS/ DELIVERY

1985 Mack DM600, 6-spd, cab replaced, 4000 gallon tank, 3 valves, Moro A-C4 pump, 1-15,000 lb. Bethlehem Mfg. mountrail bed, 18' bed, 10' boom, double post on back. 252-491-2321. (P6)

## TV INSPECTION

2003 P-448 PEARPOINT STEERABLE TRACTOR with power scissor lift, 18' to 72" pipe, S/N 448-063. Complete w/accessories. \$25,000 OBO. Dale or Mark 269-381-2400. (CMPBM)

1993 Cues Panther M/C track camera, part #CP036, serial #023, Data view III, Model 1208, Pro view P&T/RVC camera controller. Municipal owned. FOR MORE INFO PLEASE CALL JOE. 312-208-6373. (P1)

1998 Cues TV grout unit, 34,880 miles, color camera, diesel, generator. 972-938-1905. [www.empireequip.com](http://www.empireequip.com). (CPBM)

## VACUUM LOADERS

2007 Sterling LT9500 tri-axle with a new Presvac, Powervac 3800, 3,250 gallon US, DOT, wet/dry industrial, vacuum tank loader. *In Production*. (Stock #13294B) [www.VacuumSalesInc.com](http://www.VacuumSalesInc.com), (888) VAC-UNIT (822-8648). (PBM)

1986 Freightliner with 3300/300 Keith Huber vacuum truck and high pressure jetter. Tilt and full opening rear door. Used daily. See pics @ [delmardisposal.com](http://delmardisposal.com) \$38,000 OBO. 214-391-1109. (P2)

1993 International Vactor unit, with 4500 cfm rebuilt blower, low hours. Ideal for dry vacuum work, manual 8" 180-degree swing boom. \$40,000 OBO. Call 765-474-1916 for details. (P2)

## VANES

American Industrial Components: Our vanes are manufactured from the highest quality laminated materials available and are fabricated to exact tolerances and specifications. Please see our ad in this issue. 800-272-7557. (PBM)

## VANES

Dura Comp 535, high-quality non asbestos vacuum pump vanes. Good to 400°F. Buy factory direct and save. Same day shipment on most models. Jurop, Battioni, Moro, Masport, Fruitland, Demag. Long lasting Dura-Comp 535 pump vanes carry a "Money-back" guarantee. Call us today. Powerflo Products 800-758-4788 or 562-997-0720. (PBM)

## WANTED

Water jetting equipment. We rent, sell and repair water blasters. Visit us at: [www.waterjettingequipment.com](http://www.waterjettingequipment.com) or phone 714-259-7700. (CPBM)

## WATERBLASTING

Wanted to Buy: Vactor 2100s and late model Guzzlers. Cash. Phone 800-336-4369. (CPBM)

It's **EASY** to submit your classified **ONLINE!** Just go to:

[www.pumper.com](http://www.pumper.com)

Only  
**\$1.00**  
PER WORD!

CLASSIFIEDS

Place A Classified Ad

Fill in the **Online Classified Ad Blank!**

PLACE YOUR AD ONLINE AT [www.pumper.com](http://www.pumper.com) - IT'S ALWAYS THERE TO MEET YOUR BUSY SCHEDULE



# Financing Solutions for your **WASTE EQUIPMENT**

## Why TCFEF?

- TCFEF has over 30 years of experience in the equipment finance & lease industry
- TCFEF's Direct Source Lending cuts out the middle man

## Why Finance with TCFEF?

- Quick Turnaround
- Industry Expertise
- Application only up to \$350K\*
- Flexible Payment Options
- Preserve Bank Lines
- Tax Advantages
- Improve Cash Flow
- Vendor Plans Available
- Trac Leases Available on Request

## What Does TCFEF Finance?

- New and Used Equipment
- Liquid Waste Equipment  
and much more

ATTENDING THIS YEAR'S  
**Pumper & Cleaner  
Environmental  
Expo?**

Stop By Our  
Booth #19034  
and  
Say Hello!

\*Get pre-approved for a lease or  
a loan prior to the show by simply  
calling your TCFEF sales rep.

# *The Customer First*

## For more information contact:

**Craig Williams**

Regional Director

877.240.1694

E-mail: [cwilliams@tcfef.com](mailto:cwilliams@tcfef.com)

TCFEF Booth #19034

**Kevin Steier**

Regional Sales Manager

888.880.1617

E-mail: [ksteier@tcfef.com](mailto:ksteier@tcfef.com)

TCFEF Booth #19034



**Experts at Delivering Equipment Finance Solutions**

11100 Wayzata Boulevard • Suite 801 • Minnetonka, MN 55305





# VSI Vacuum Sales Inc.

51 Stone Rd. | Lindenwold, NJ 08021

888-VAC-UNIT | 888-822-8648 | Fax: 856-627-3044  
E-mail: vsisales@aol.com | www.VacuumSalesInc.com

## NEW EQUIPMENT CUSTOM BUILT TO YOUR SPECIFICATIONS



(13298 A & B) **2008 Peterbilt 340** cab & chassis with a New Presvac 3,200 gallon, c/s, DOT certified 407/412 vacuum tank; Dump Type with full open rear door & a Presvac PVB 750 vacuum-pressure pump.



(2104V) **1999 Freightliner FL60** with a 1,000 U.S. gallon waste, 250 U.S. gallon water; 250 U.S. gallon mix; 3-compartment, Stainless Steel vacuum tank, with a NVE 184 vacuum pump and washdown system.



(2362V) **1996 International 4700** cab and chassis with a 1,800 U.S. gallons, 2 compartment (1200 waste/600 water); carbon steel, vacuum pressure tank with jetting system.



(13289) **New Presvac 2,000** U.S. gallon 2-compartment (1500/500), Aluminum vacuum tank, with a Moro M3 vacuum-pressure pump installed on a 2007 Chevy C7500 Cab and Chassis.



(8734) **1998 International 4700** with a 1,500 U.S. gallon, 2-compartment (1100/400 split), Carbon Steel; portable toilet service unit.



(13281B) **2007 Sterling LT9500** new Presvac, Powervac 3800, 3,250 gallon DOT, wet/dry industrial, vacuum tank loader.



(13329V) **2001 Freightliner C120** can and chassis with a new Presvac 3,200 gallon DOT 407/412 Certified Vacuum - pressure tank.



(5371V) **1994 Mack RD6905 w/ Presvac 4,400 Carbon Steel 2-compartment DOT Cert Vacuum Tank.**



(13297A) **2007 Peterbilt 340** with a Presvac 3,600 gallons (US), aluminum vacuum tank unit.



(8734C) **1997 Ford LT9513** with a Presvac 5,000 U.S. gallons; Carbon Steel; Vacuum-pressure tank.

## CADMAN / ALBERS

### For Emergency or Temporary Storage of Liquids



- Safe, affordable enclosed storage.
- Up to 1.3 million U.S. gallons of capacity.
- Various agitator options.
- Neighbor friendly odor control.
- Blends in with the surroundings.

**We also offer fully portable, transportable systems. Your containment solution is only a phone call away.**



38 Main St. • Courtland, Ontario, Canada  
**1-866-422-3626**  
www.cadmanpower.com

## One Complete Package

[pumper.com](http://pumper.com)

[promonthly.com](http://promonthly.com)

[onsiteinstaller.com](http://onsiteinstaller.com)

[mswmag.com](http://mswmag.com)

[cleaner.com](http://cleaner.com)

[pumpershow.com](http://pumpershow.com)

[pumpertrader.com](http://pumpertrader.com)

[septicyellowpages.com](http://septicyellowpages.com)

[sewerpages.com](http://sewerpages.com)

**Cole Publishing | 1.800.257.7222 | 715.546.3346**

## "Duel Power Lid"

Plugs, Lids & Adaptor Rings  
Sizes Available:  
**18", 24", 30" & 36"**

**Fergus Power Products**  
Providing "Environmental Products"  
*The Company who maintains a pulse on the environment!*

Toll Free **1-800-243-7584**  
E-mail [fpproducts@prtcl.com](mailto:fpproducts@prtcl.com)

**The Leasing Experts**  
Equipment Leasing & Financing  
1-888-505-0060

- 100% Financing Available
- One-Page Application for \$5,000 to \$100,000
- Same Day Response

Call For More Information: 1-888-505-0060  
Website: www.equipmentleasingbiz.com

**New Terralifts for sale!**  
**\$29,900**

We only have **three**, and we won't be at the show.

**Tribill, Inc.**  
413 236 0935

**DYE TRACERS**

Solutions for:

- Infiltration
- Septic Systems
- Cross Connection
- Leaks and more...

**BRIGHT DYES**  
Division of Kirgocin Chemicals  
www.brightdyes.com • FAX: 937-886-9300

NSF Certified to ANSI/APF Co.

Booth 3055

FREE SAMPLE 1-800-394-0678

**90 DAY JETTER TRIAL**

Plumbers - Let us improve your bottom line



13HP  
4000 PSI  
**\$1,949**  
Free Freight

COMPLETE DETAILS AT  
www.amazingmachinery.com

1-800-504-7435

"You're going to **WORK**, not **WRI!**"

ARE YOU STILL USING A HOOD OR PICK AXE TO REMOVE SEPTIC TANK COVERS? NOW THERE IS A BETTER WAY!

Booth 18024

Eliminate back injuries with BigsEasyLift

Call for a **FREE 30 Day Trial**

phone: 612.860.7047  
fax: 866.271.9057  
email: info@BigsEasyLift.com  
www.BigsEasyLift.com

**BIGS EASY LIFT**

**STOP!**

DON'T ORDER ANY MORE BIOPRODUCTS UNTIL YOU FIND OUT ABOUT BioOne®'s **REVOLUTIONARY TECHNOLOGY.**

Drain Line, Grease Trap, Septic System Maintenance.  
Profitable, Easy to Sell, Simple to Use.

There's nothing else like it.  
Professional strength, EPA-recognized BioOne®.

Booth 3045

CALL FOR A FREE SAMPLE

**BIO One**  
800-951-4246  
One Biotechnology • www.1biotechnology.com

**Mobile Dewatering Service**

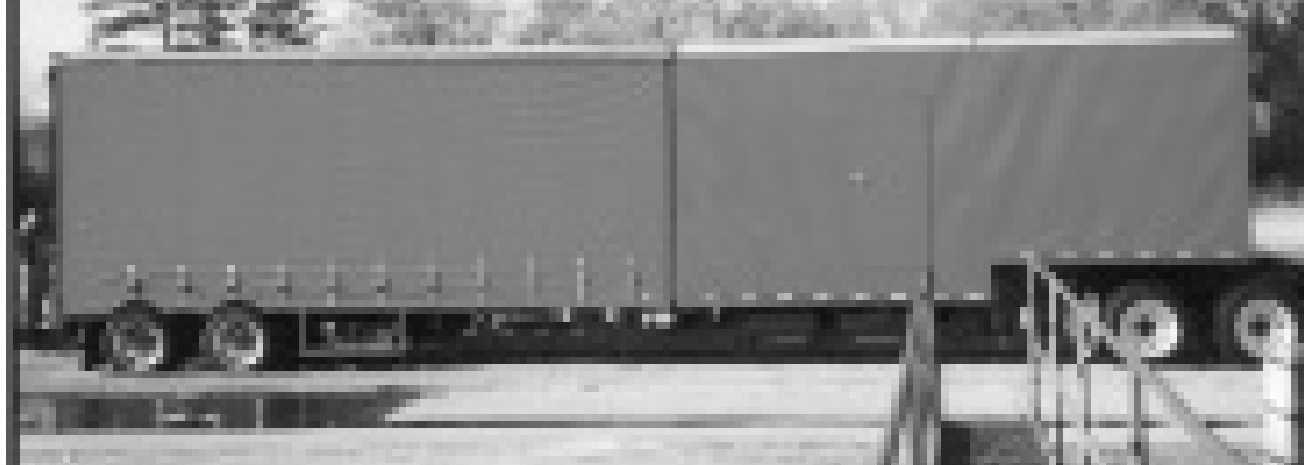

Municipal & Industrial Sludge Digesters, Lagoons, Ponds, etc.

- Double Belt Filter Press
- Up to 25% Drier Cake
- Professionally Staffed
- US & Canada

**Fluid Technology, Inc.**  
P.O. Box 937, Oxford, OH 45056  
Phone: 513-981-7808  
E-mail: sales@fluidtechinc.net  
Web site: www.fluidtechinc.net

# Marketplace Advertising

WWW.ROOTERMAN.COM

**ROOTER-MAN**  
"To The Rescue"

Booth 9015 & 9115

Franchises available with low, flat fee  
New concept. Call 1-800-700-8062.

FRANCHISE PACKAGE \$7,950.

**EASILY MOVE RESTROOMS**

- ✓ Aluminum Frame
- ✓ Ships UPS
- ✓ Carry ADA's
- ✓ Models starting at \$380

Booth 6059

Available with 2, 4, 6 or even 8 wheels and your choice of air or solid foam tires.

**Super Mongo Mover®**

**DA**  
Deal Assoc. Inc.  
www.dealassoc.com  
**866.599.3325**



**MAKE YOUR MOVE**

February 27 - March 1, 2008

**PUMPER & CLEANER International ENVIRONMENTAL EXPO**

**Louisville 2008**

More info at www.pumpershow.com or 1.800.257.7222

MAKE YOUR MOVE

**T&T TOOLS T&T Tools**  
800-521-6893  
800-521-3260 FAX  
E-mail sales@tandttools.com • www.tandttools.com



Mighty Probe™  
Sludge Hoe™ (insulated)  
Sludge Spud™  
Manhole Hook  
Tommy Hook™  
Striking Head™

Handy Hook™  
Water Probe  
Curved Spud™

Top Popper™  
Ground Buster™  
Smart Stick™ (standard)

Booth 3099

www.tandttools.com



**Kwikk-Lokk**  
 Vacuum Truck  
 Couplers and Hose.  
 www.kwikk-lokk.com  
 (814) 899-3644

**PIT HOG** PUMPS  
 WASTE  
 LWT manufactures  
 manned and remote  
 controlled lagoon  
 dredges and pumps.  
 Rental dredges also  
 available.  
 LWT LIQUID WASTE  
 TECHNOLOGY.  
 Box 250, 422 Main St., Somerset, WI 54025  
 www.lwtpithog.com / 1-800-243-1406



**AERRATECH**  
 Aerratech, LLC  
 ❖ New and Used Terralifts ❖  
 ❖ All Parts Available ❖  
**SHOW SPECIAL!**  
**\$34,900**  
 Come see us at  
 Booth 21000  
 Sales: 603 253 4774  
 Parts and Service: 888 298 4272

Aluminum  
 Vacuum Tanks  
**ALUMATANK**  
 progress tank.com  
**PORTAVAC**  
 Septic & Restroom  
 Service

Refrigerator **MAGNETS**  
 500 Minimum -  
 Call for  
 pricing  
**43¢**  
**EACH!**  
 Actual Size:  
 4" x 1-3/4"  
 VAN & PUMPER  
 TRUCK SHAPES  
 1-800-758-2743  
 254-829-0373  
  
 2-color Imprint - Quantity Discounts

**NEED  
 GLOVES?**  
 • 14" Gauntlet  
 • Plastic  
 Coated  
 • Sandpaper  
 Finish Grip  
 • Jersey Liner  
 • One Size Fits All  
**\$35** PER  
 DOZEN **\$189** FOR 6  
 DOZEN  
 TO ORDER, SEND A CHECK/  
 MONEY ORDER OR CALL US TOLL  
 FREE! Make checks payable to:  
 ADVANCE GLOVE CO.  
 Please include  
 UPS shipping address  
 Major  
 Credit Cards Accepted!  
**ADVANCE GLOVE CO.**  
 80. BOX 149 • LENON, WI 48449  
 100-488 • 1.800.323.1223

1.800.257.7222

**Marketplace**  
 advertising

**Deadlines:**  
**Pumper: 10th of the month\***  
 \*PRECEEDING ISSUE DATE

**Pumper.**

Pumper Marketplace gives you nationwide exposure to  
 thousands of industry professionals. **Now Available In 4-Color**

Layout and design is included **FREE**, and we can fax or e-mail you a proof for final approval!

Choose a size that works best for you!

<b>Size A: \$309<sup>00*</sup></b>	<b>Size B: \$209<sup>00*</sup></b>	<b>Size C: \$109<sup>00*</sup></b>
<b>1.875" w x 4.875" h</b>	<b>1.875" w x 3.2" h</b>	<b>1.875" w x 1.5" h</b>
This size is great for 2 photos!	Perfect size for one photo!	A great value!

\*Black and white prices, call for 4-color pricing.

[Send ad materials and payment to:  
 COLE PUBLISHING INC. • P.O. BOX 220 • THREE LAKES, WI 54562]

## PADLOCKS

- Your Padlocks
- Your Key Number
- Any Quantity
- Best Prices

PUMP

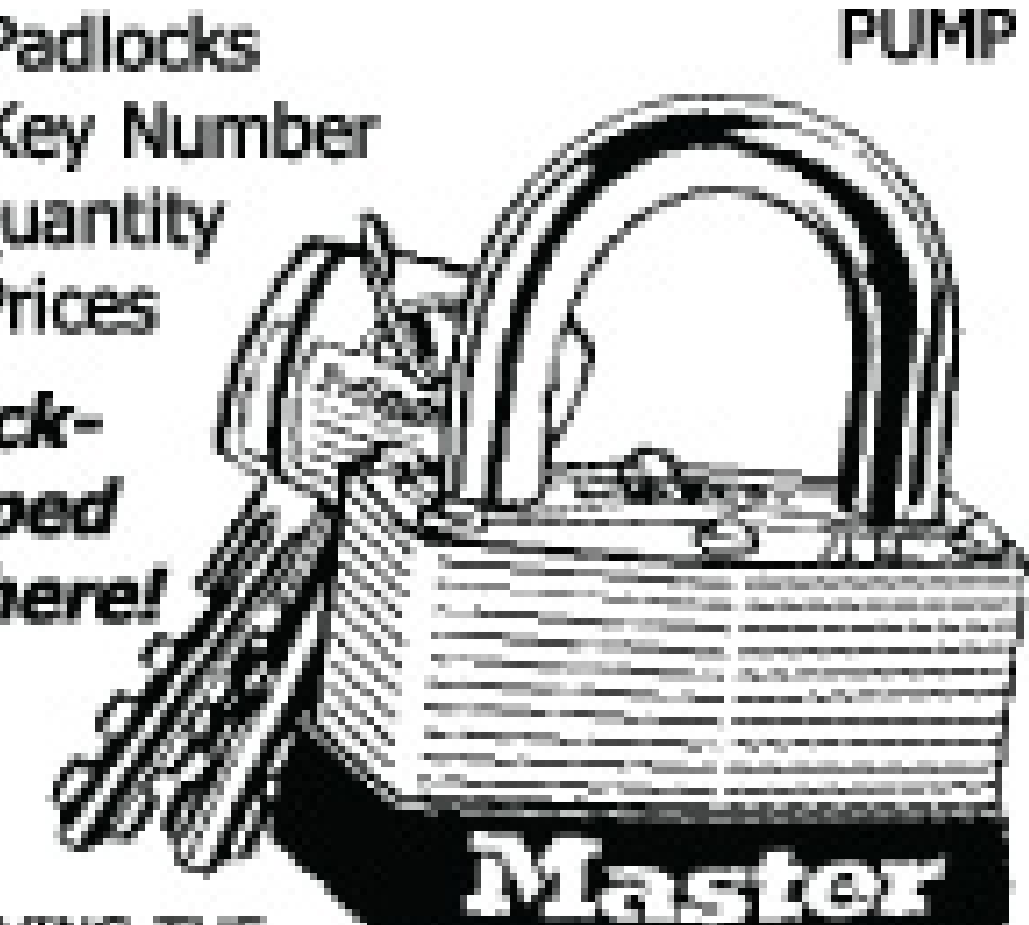

**Master**

SERVING THE PORTABLE SANITATION INDUSTRY FOR 14 YEARS— WE'RE THE BETTER WAY TO BUY PADLOCKS™

**Call For FREE CATALOG or Instant Quote!**

**LockMasters**  
1-800-461-0620  
www.lockmastersusa.com

sales@lockmastersusa.com • Fax (850) 914-9754

## SEPTIC SEEP

RESTORING DRAINFIELDS FOR OVER 50 YEARS!



Over 90% of septic systems fail due to problems in the drain field.

**THIS MONTH ONLY: MENTION THIS AD AND GET A CASE (4 GALLONS) FOR ONLY \$123.50!**

Visa & MasterCard Accepted  
**1-800-537-5800**

**1-800-333-9274**  
www.Jettersonline.com

### Pressure Washers

**HONDA @ 2700PSI \$377**  
**HONDA @ 3000PSI \$416**  
**HONDA @ 4000PSI \$859**

We Customize high pressure pumps

### Honda Engines

5Hp GC	\$199
6.5Hp GX	\$349
8Hp GX	\$459
9Hp GX	\$489
13Hp GX	\$589
18Hp GX	\$1,099

**BEST Sellers ALWAYS on Sale**

5.6GPM @ 4000PSI	\$399
8.0GPM @ 3500PSI	\$499
7.0GPM @ 5000PSI	\$599

Call For Free Quotation. We Also Stock Pumps With Left Hand Drive, Tapered Shaft, Car Wash Duty, 316 Stainless Steel and Unique Applications  
**1-800-964-9274**

Water Cannon - 5 Offices Nationwide, Since 1981

## The Ultimate Toilet!

- No Plumbing
- Installs Anywhere
- No Pump-Outs
- No Odor



**SUN-MAR**

## Composting Toilets

**1-888-341-0782**  
www.sun-mar.com/pp

## SEPTIC ODOR PROBLEM?

ODORHOG™ Charcoal Activated Vent Pipe Filters Remove Sewer & Septic Odors from Plumbing Vents



Patent Pending

ODORHOG™ Filters Come in 5 Standard Sizes or Any Custom Size You Specify  
SAME DAY SHIPPING & PRIVATE LABELING AVAILABLE  
**A&M BIO-FILTER, LP**  
1.800.963.6746  
www.odorhog.com

Order online at [www.odorhog/pumper.shtml](http://www.odorhog/pumper.shtml) for our **JANUARY SPECIAL OFFER!**

## Simple Solutions

DISTRIBUTING LLC

**We Stop The Stink Guaranteed!**  
Budget Conscious Solutions for Wastewater Odor Control.

**ODOR ADSORBERS FOR:** • Manhole Openings  
• Lift Station Vents • Plumbing and Septic Vents  
• Large Industrial Applications

Mention this Ad and Save 10%!! 20% on orders over \$2000!!



**973-846-7817 or 866-667-8465**

www.IndustrialOdorControl.com Booth 49  
www.StopSepticOdor.com

# DISCOUNT ALUMINUM

## SHEET, COIL, PLATE

**3003/5052/5454/5083/5086 AND MORE**

**20 MILLION POUND INVENTORY**

**ARE YOU PAYING TOO MUCH?**

**1-888-540-0066**  
**ASK FOR JAYSON**

FAX: **440-286-2229**  
E-MAIL: [captaluminum@msn.com](mailto:captaluminum@msn.com)



## ASHLAND PolyTraps

Grease, Oil, Hair and Lint Traps and Interceptors

- NO Rust or Corrosion
- Lightweight
- Very Cost Effective
- Sizes up to 560 Gallons
- Made in the U.S.A.!

**LIFETIME WARRANTY!**  
Certified by U.P.C., IAPMO and P.D.I.

**800-541-8004**  
PolyTraps@Amplex.net



**PUMPER & CLEANER International ENVIRONMENTAL EXPO**



**Big & Rich**  
in Louisville, March 1

## Water Jets for Rent



- Units from 10,000 to 40,000 psi
- 100-425 hp
- Diesel or electric
- Rent, buy or lease
- Branches in Michigan, Texas, New Jersey, Louisiana, California

**NLB Corp.** Call toll-free, 877-NLB-7996  
www.nlbcorp.com



By **Scottie Dayton**

## **NATION: PSAI Awards Announced**

The Portable Sanitation Association International recognized Ed Cooper of PolyJohn Enterprises Corp. in Whiting, Ind., at its annual convention in November. Cooper, who was on the association's board of directors, received the 2007 M.Z. "Andy" Gump Award for eminent service to the industry. He was nominated by Barry Gump of Andy Gump Inc., Santa Clarita, Calif. Mike Cooper accepted the award on behalf of his father, who died four days later.

Cesar Torres of Biffs Inc. in Shakopee, Minn., received the Service Technician of the Year award and \$1,000 prize. The runner-up was Nicki Dunn of Air-O-Pure Portables in Nederland, Colo., who received \$500.

Nominees must promote safety, set an example and inspire others. Award criteria include practicing road and personal safety, providing dependable customer service, caring for the company's equipment, and cooperating and complying with the employer and industry guidelines and standards.

## **KENTUCKY: Friend of a Friend**

The Kentucky Onsite Wastewater Association made certain its membership had the resources, experience, and professionalism needed to lead the state's growing acceptance of onsite systems. Recently, KOWA teamed with the Kentucky Rural Wastewater Association to increase KOWA's visibility to legislators, utilities and communities. KOWA will choose the issues, education and direction the organization wants to take, and the KRWA team will do the leg-work.

The association newsletter tells how the organization helped a family whose drainfield was overflowing. The parents have five of their own children and four adopted children and were hosting a foreign exchange student. The onsite system had a 1,000-gallon septic tank with 400 feet of laterals.

Todd LaFollett, registered sanitarian with the Oldham County Health Department, consulted with regulator Wyatt Moody on a repair plan, resources, materials and labor. Greg Ritchie, KOWA president, said the association training center had leftover chambers from Advanced Drainage Systems Inc. Installer Greg Thompson, who lived 90 minutes from the jobsite, learned about the situation and offered his labor and equipment free of charge.

## **OHIO: Corporate Membership**

The Ohio Onsite Wastewater Association has added corporate memberships for companies that includes one key contact person. For \$120, companies receive OOWA and NOWRA benefits, and may add employees as associate members for \$50 each. Associate members receive only OOWA benefits. Individual memberships at \$95 carry OOWA and NOWRA benefits. Call 866/843-4429 or visit [www.ohioonsite.org](http://www.ohioonsite.org).

OOWA is offering the NEHA Certified Installer of Onsite Wastewater Treatment Systems basic and advanced level exams at its conference on Jan. 15 in Columbus. To take the exams, installers must complete an application form and be approved by NEHA. Download the form at [www.neha.org/onsite](http://www.neha.org/onsite) or call Heidi Shaw at 303/756-9090, ext: 339.

## **Chlorine or Ultraviolet Disinfection?**

A case study in *Small Flows* compares a commercial chlorine tablet feeder with an ultraviolet disinfection unit for onsite systems. The systems were operated for nine months using biologically treated septic tank effluent. Both provided comparable results and experienced intermittent problems: the chlorine tablets did not dissolve uniformly and minerals collected on the lamp sleeve, eventually reducing its performance. The article discusses each unit's performance measurements, reliability and constraints, maintenance requirements, and estimated cost of implementation and operation.

Another article gives a rational method for determining design flows for cluster systems. Author Larry Stephens, P.E., discusses what factors to consider in developing a design. He sets forth a methodology for using the demographics of the surrounding community, obtained from the latest census data, to estimate design flow. Download the issue at [www.nesc.wvu.edu/nsfc/sfq\\_2007.htm](http://www.nesc.wvu.edu/nsfc/sfq_2007.htm).

## **NAWT Training and Certification**

The National Association of Wastewater Transporters Inc. is offering Inspector Training & Certification Jan. 28-29 at the River Palms Resort and Casino in Laughlin, Nev. Call 800/236-6298 or visit [www.nawt.org/training.html](http://www.nawt.org/training.html).

## **Effluent Pumps for Onsite Systems**

The Sump and Sewage Pump Manufacturers Association is presenting "Effluent Pumps for Onsite Wastewater Treatment: Selecting the Right Pump for the Job," a non-credit training program, on March 14 at the Illinois Plumbing Heating Cooling Expo at Drury Lane Conference Center, Oakbrook Terrace, Ill. The program is in its certification stage and will become eligible for CEUs. Call 800/795-7422 or visit [www.ilphcc.com](http://www.ilphcc.com).

## **Florida**

Courses are at the Florida Onsite Wastewater Association's Training Center in Polk City unless stated otherwise. An asterisk indicates Master credit hours are available.

- Jan. 15 – Management of Decentralized Systems
  - Jan. 23-24 – \*O & M Service Provider Program I, II, III, Fort Myers
  - Feb. 6 – 64E-6 Let's Look at the Code, Hialeah
  - Feb. 7 – 64E-6 Let's Look at the Code, Tampa
  - Feb. 11 – Artificial Media Treatment Technologies
  - Feb. 12 – Natural Media Treatment Technologies
  - Feb. 18-19 – \*Master III-Basic Florida Soils
  - Feb. 20-21 – \*Master I-System Design & Function
  - Feb. 21-22 – \*Master II-System Materials and Regulation Requirement
  - March 6 – \*Master Contractor Maintenance
  - March 11 – Onsite Systems: How Are They Approved?, northeast Florida (TBD)
  - March 12 – Onsite Systems: How Are They Approved?, southwest Florida (TBD)
  - March 25 – Work Smart, Not Hard, southeast Florida (TBD)
  - March 26 – Work Smart, Not Hard, southwest Florida (TBD)
- Contact FOWA at 407/830-4381 or [www.fowaonsite.com](http://www.fowaonsite.com).

## Minnesota

The University of Minnesota Extension has these hands-on workshops:

- Jan. 7-9 – Introduction to Onsite Systems, Alexandria
- Jan. 10-11 – Installing Onsite Systems, Alexandria
- Jan. 15-16 – Installer-Continuing Education, Rochester
- Jan. 16 – Pipelayer Certification, Rochester
- Jan. 23-25 – Designing Onsite Systems, Sauk Centre
- Feb. 5-6 – Design-Continuing Education, Sauk Centre
- Feb. 5-7 – Design and Large System Combo, Continuing Education, Sauk Centre
- Feb. 6-7 – Cluster-Continuing Education, Sauk Centre
- Feb. 11-13 – Pumping/Maintaining, Grand Rapids
- Feb. 14-15 – General-Continuing Education, Detroit Lakes
- Feb. 21-22 – General-Continuing Education, Two Harbors
- March 11-12 – General-Continuing Education, Willmar
- March 14 – Contractor Safety/Pipelayer Certification, Continuing Education, Mankato
- March 25-26 – Pumping/Maintaining-Continuing Education, Brainerd
- March 31-April 1-2 – Introduction To Onsite Systems, Bemidji  
Call 800/322-8642 (612/625-9797) or visit [www.extension.umn.edu](http://www.extension.umn.edu).

## Missouri

The following training seminars from the Missouri Smallflows Organization provide CEUs to renew onsite registration with the Missouri Department of Health and Senior Services:

- Jan. 8-9 – Troubleshooting & Hydraulics, St. Louis
- Jan. 15-16 – Operation and Maintenance, Cape Girardeau
- Feb. 19-20 – Operation and Maintenance, Hillsboro  
Call 417/739-4100 or e-mail [mso@lvbw.net](mailto:mso@lvbw.net).

## North Carolina

North Carolina Soils and On-Site Wastewater Training Academy is offering a Land Application/Residuals (Biosolids) Operator Training School on April 22-24 at North Carolina State University, Raleigh. Call Joni Tanner at 919/515-1678 or visit [www.soil.ncsu.edu/training](http://www.soil.ncsu.edu/training).

## Washington State

The Washington On-Site Sewage Association and Washington State Department of Health in cooperation with Washington State University are offering these certification courses at the training center in Puyallup unless stated otherwise:

- Jan. 3 – Basics of Maintenance
- Jan. 10 – Basics of Installing, Part 3

Call John Thomas at 253/770-6594 or visit [www.wossa.org](http://www.wossa.org).

## Wisconsin

Wieser Concrete has a 6-hour, general continuing education seminar that provides the necessary credits for installers, sanitarians, designers, and others working in the onsite wastewater treatment field. Seminars will be held:

- Feb. 28 – Portage
- March 6 – Shell Lake
- March 13 – Fond du Lac
- March 20 – Wieser Concrete Maiden Rock Facility
- March 28 – Rhinelander

Call 800/325-8456 or visit [www.wieserconcrete.com](http://www.wieserconcrete.com). ■

## C A L E N D A R

### Jan. 7-8

Wisconsin Precast Concrete Association Winter Convention, Holiday Inn & Suites, Madison. Call 608/256-7701.

### Jan 8-10

Michigan Septic Tank Association Onsite Wastewater Conference. Call 989/773-6985, ext: 258 or visit [www.msta.biz](http://www.msta.biz).

### Jan. 15-17

Ohio Onsite Wastewater Association Conference and Trade Show, Midwest Hotel and Conference Center, Columbus. Call 866/843-4429 or visit [www.ohioonsite.org](http://www.ohioonsite.org).

### Jan. 16-17

Soil Science Society of North Carolina Annual Meeting, Raleigh. Call 919/380-1202 or visit [www.carolinaonsite.org](http://www.carolinaonsite.org).

### Jan. 21-22

Pennsylvania Septage Management Association Conference, Holiday Inn, Grantville. Call Jackie at 610/350-0590, press #3 or visit <http://psma.net>.

### Jan. 21-23

Missouri Smallflows Organization Conference and Exhibition, Holiday Inn Expo Center, Columbia. Call 417/739-4100 or visit [www.mosmallflows.org](http://www.mosmallflows.org).

### Jan. 22-23

Iowa Onsite Waste Water Association Conference, Des Moines Airport Holiday Inn. Call 515/225-1051 or visit [www.iowwa.com](http://www.iowwa.com).

### Jan. 25-26

Washington On-Site Sewage Association Conference, Vancouver Hilton, Vancouver. Call 253/297-2837 or visit [www.wossa.org](http://www.wossa.org).

### Jan. 25-27

Wisconsin Liquid Waste Carriers Association Winter Convention, Chula Vista Resort, Wisconsin Dells. Call 608/255-2770 or visit [www.wlwca.com](http://www.wlwca.com).

### Jan. 28-30

North Carolina Septic Tank Association Convention, Hickory Metro Convention Center, Hickory. Call Connie Stephens at 336/416-6394 or visit [www.ncsta.net](http://www.ncsta.net).

### Feb. 13-14

Nebraska On-Site Waste Water Association Annual Convention and Trade Show, Embassy Suites Hotel, Lincoln. Call Diane Snapp at 402/476-0162.

### Feb. 15-16

Wisconsin Onsite Wastewater Recycling Association Convention, Country Springs Hotel, Waukesha. Call 608/256-7757 or visit [www.wowra.com](http://www.wowra.com).

### Feb. 27-March 1

Pumper & Cleaner Environmental Expo International, Kentucky Exposition Center, Louisville, Ky. Education Day Feb. 27; exhibits open Feb. 28-March 1. Call 800/257-7222 or visit [www.pumpershow.com](http://www.pumpershow.com).

### March 2-4

Ontario Onsite Wastewater Association Conference, Deerhurst Conference Centre, Huntsville. Call 905/372-2722 or visit [www.oowa.org](http://www.oowa.org).

### March 3-5

Minnesota Onsite Wastewater Association Convention, Cragun's Resort, Brainerd. Call 888/810-4178 or visit [www.mowa-mn.com](http://www.mowa-mn.com).

### March 11-13

Northeast Onsite Short Course, Marriott Hotel and Spa, Groton, Conn. Call 978/323-7929 or [www.nelwpc.org](http://www.nelwpc.org).

### March 24

Granite State Designers and Installers Association Septic System Conference & Exhibition, Radisson Hotel, Manchester, N.H. Call 603/228-1231 or visit [www.gsdia.org](http://www.gsdia.org).



## LOCATING MADE AFFORDABLE

**WHETHER YOU ARE JUST GETTING STARTED OR YOU ARE AN OLD PRO**, you can rely on Prototek for the best flushable transmitter and receiver systems in the industry. **FLUSH AND FIND** Locate underground nonmetallic tanks and lines with our orange AT-12 flushable transmitter and AR-1 receiver. Locate in cast iron or nonmetallic lines with our blue FT-8 flushable transmitter and FR-1 receiver. Recycle your used AT-12s or FT-8s back to us for credit toward your next purchase. Use your AR-1 for tracing metallic lines or utilities with our **BuzzBox!** Operates at 223 KHz, 3 watts max power, in 3 ranges, Ground rod and cables included.



**Prototek**



SEE YOU IN LOUISVILLE  
BOOTH #3187

ECONOMICAL • EASY **800-541-9123**  
www.prototek.net email: prototeksales@prototek.net

## TRUCK TOWN

2601 East Hwy. 80 • Abilene, Texas 79601

FULL SERVICE VACUUM SYSTEMS SUPPLIER

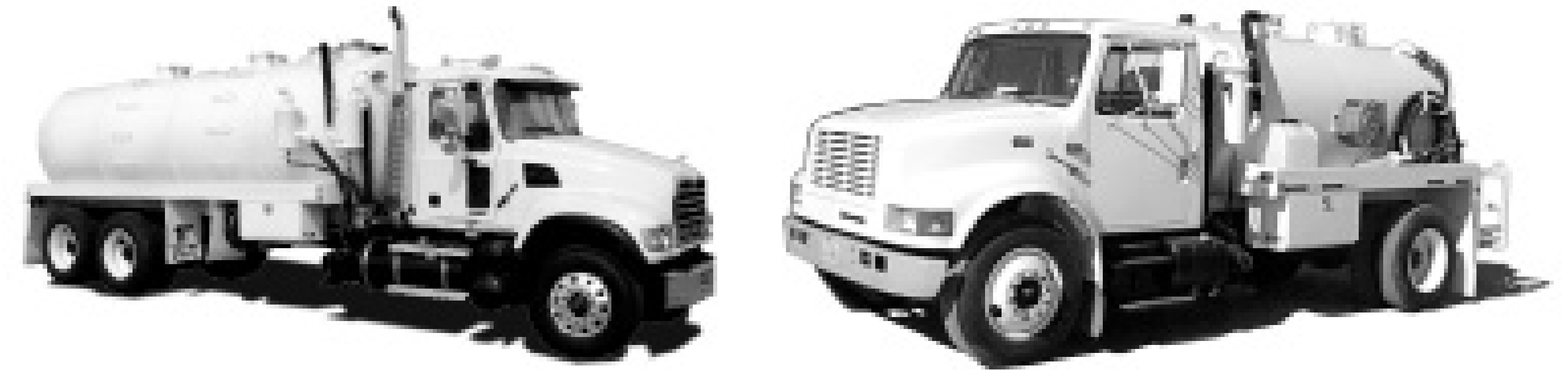

**1-800-727-0350**

**GOOD ASSORTMENT OF CUSTOM SPEC TRUCKS  
FOR YOUR VACUUM UNIT NEEDS**

LELY SEPTIC & OIL FIELD VACUUM TRUCKS  
TROXELL TRAILERS



JEFF MULLICAN • HUBERT YOUNG • DENNIS ADAMS

Phone: 325-673-4642 • Fax: 325-673-4673  
Web Site: www.truck-town.com • E-mail: truck@camalott.com

## • No Financials Required

Application Only to \$250K

## • No Age Restrictions

Used Equipment (30+yrs still ok)

## • Seasonal Payment Plans

- Bucket Machines
- Cable Machines
- Catch Basin Cleaners
- Combo Sewer Cleaners
- Dewatering/Composting
- Hydro Excavators
- Jetters
- Liquid Vacuum Trucks
- Trailer Mounted Combo
- Sweepers
- Vacuum Loaders
- and much more.....

## • Working Capital

Start-Ups Welcome

## • Sale Leasebacks

Simple One Page Application

## • Private Party Sales

ACG IS A FULL IN-HOUSE LENDER. OUR TEAM OF PROFESSIONALS PROVIDE SAME-DAY DOCUMENTATION AND FUNDING. LET US STRUCTURE A PROGRAM THAT BEST FITS YOUR BUDGET WITH INSTANT CREDIT DECISIONS. LESS THAN PERFECT CREDIT (FICO 580+) IS APPROVABLE!



**Bryan Joy 800-830-0084 x214**

9436 Hamilton Dr. • Mentor, Ohio 44060 • Fax 800-830-9855 • www.1acg.com

# Pumper

see photos in COLOR at [www.pumper.com](http://www.pumper.com)

# TRUCK STOP



**1999 Peterbilt:** 12.7 Detroit, 470 hp, 129K miles, AC, cruise, 10-spd., Jake brake, 18 front, 46 rears, Hendrickson susp., new 4000 gal. tank & Masport 400 vac pump, complete new unit, new paint & tires. Financing available.....\$79,000  
**877-898-5104**  
[hullstruckbodies.com](http://hullstruckbodies.com) P1



**1996 Ford L8000 Septic Pumper:** 2,500 gal. Boyd tank, Masport pump, heated valves, 63K miles, 33K GVW, Ford/Cummins 8.3L diesel, 6-spd. trans., A/C. Located in Scituate, MA 02066. ..\$32,900  
**781-545-2596, 617-697-2607,**  
**617-697-2606** P1



**Shower and Restroom Trailers:** Platinum and Gold Series, new and used available. Each with separate men and women sides.  
**CCI/Brian Touey 805-896-3777** PBM



**2005 F550 4X4 Diesel:** 6-spd., XL package, 950 gal. tank, 600 waste, 200 chemical, 150 fresh, 2-place toilet rack, 93,000 miles, H2 Masport pump .....\$35,000  
**Call Ryan at 801-430-7287** P01



**2001 FL70:** Cat 9-spd. w/105,000 miles, Transway 500 cfm pump, 1500 waste, 500 fresh, heated water & valves, 9 gpm, 3,000 psi jetter, 300' 1/2" hose, toilet rack, ss hose tray. ....Asking \$47,500  
**800-500-5096** P1



**1995 Ford Guzzler:** Ex-municipality, PD blower, 88,000 miles, 8.3 Cummins, 8 LL, perfect working order.....\$55,000  
**503-969-9557 or 503-682-2723** P1



**2001 International 4700 466E:** 5-spd. w/overdrive Allison 2000P, 2200 gal. vac. tank, Moro M-10 230 cfm, great condition, all new tires, 61,000 miles, Arizona - no rust. ....Asking \$39,500  
**520-378-9569** P01



**2001 International Septic/Grease Pump Truck:** Cummins 400 hp, 8-spd. trans., Presvac 4200 gal. w/200 gal. fresh water for Harben jetter. 4000 psi, 300' jet hose, 400 cfm Demag vac. pump. ....Priced to sell \$64,000  
**Call Don 954-943-9100** P3



**2000 Mack:** With 330 hp, 10-spd. with auto. shift, new 3600 gal. aluminum tank, R260 Juro-Pak, storage cabinet passenger side.  
**800-722-8384** PBM



**1995 Ford LN 8000 Vac-Con:** Low miles, Allison trans., 3-stage fan, 12-yd. debris, 1500 gal. fresh water for jet, 30 gpm @ 2500 psi. Well maintained, ready to work. ....Priced to sell \$58,000  
**Call Don 954-943-9100** P3



**1987 GMC 7000:** 150,000 miles, 1200 gal. tank, 150 gal. fresh water, hoist, 25" manway, 3" inlet, 6" dump. ....Asking \$20,000  
**Call David 309-937-5559**  
**or 309-507-0411** P2



**1998 F-800:** 2350 gallon, air conditioning, Masport pump, tank lift, 3,000 psi jetter system, super nice, perfect set up, towing hitch on back, can pull your tractor. ....\$35,000  
**561-688-1002** P1



**International Port-O-Let Trucks Available For Sale:** Auto trans, diesel. 2001: \$27,000; 2000: \$25,000 OBO. Run great!  
**For more info call 954-325-8828** P1



**1998 Vactor 2100/1998 Intl. 2554 Chassis:** Fuller RT8908LL trans., 18,000# front, 40,000# rear axles, 4' extendible boom, 80 gpm @ 2500 psi water system, many items not listed. Municipality owned. (Stock 1444)  
**For More Info. Please Call Joe**  
**312-208-6373** P1



**VacCon Model MV-311 THA:** Municipally owned & maint., Ford auto. trans. chassis, tires 95%, new hyd. driven 3-stage blower, recent rebuild on water pump, spring loaded wash down gun & hose reel, arrow brd., strobes, behind cab toolbox, 94,407 miles, 4,541 hrs. ....\$70,000 OBO  
**Pat's Pump & Blower 800-359-7867** CP1



**2007 Sterling Cab:** With 3600 gallon aluminum P/V tank with Juro-Pak R260. ....\$116,000 including FET  
**800-722-8384** PBM



# Pumper TRUCK STOP

see photos in COLOR at [www.pumper.com](http://www.pumper.com)



January



**2000 Volvo:** 5,000 gal. tank, air conditioning, cruise, Fruitland pump. Super clean and nice. 3,000 psi jetter system.  
.....\$70,000  
**561-688-1002** P1



**1987 International Model 1954:** Looks and runs great. New DT466 motor with a 2,000 gal. tank, PresVac Fruitland pump which works great. Tires are good, too!  
.....\$9,500  
**603-668-5368** P1



**1999 Vactor 2110/1999 Sterling:** Cat 3126, Allison auto. trans, 80 gpm, 2500 psi, debris body flush-out, fold-down pipe rack, many other items, municipality owned. (Stock 1445) **For More Info. Please Call Joe**  
**312-208-6373** P1



**2002 Aluminum Tank:** 4200 gallon, Jurop 230 pump, 20" manway and cleanout, 4" intake and 6" discharge. Cost \$35,000 new. ....Take \$25,000 OBO  
**817-613-6318 (Texas)** P1



**1994 Vactor:** Hot shift PTO, fuel/water separator, front and rear tow hooks, joystick boom control, fold-down pipe racks, curb and street side, municipally owned. (Stock 1452) **For More Info. Please Call Joe**  
**312-208-6373** P1



**2001 VacCon Model PD1113HA:** LT9501 chassis, Cat C10-350 hp diesel engine, Allison auto. trans., only 6,720 hrs., 68,715 miles, single engine, municipally owned, Roots 824 blower, 11 cubic yard capacity. ....\$107,000 OBO  
**Pat's Pump & Blower 800-359-7867** CP1



**1995 IH DT 466:** 6-speed, 2200 gal. tank, 120 gal. fresh, 7 years old, 360 National pump, 247,000 miles. PA.  
**814-669-4175** P1



**1991 Vactor 2110/Ford L8000:** Fold-down pipe racks, debris body flushout, municipally owned. Call for full specs and details. (Stock 1453)  
**For More Info. Please Call Joe**  
**312-208-6373** P1



**1981 Ford 8000 Vactor/Jet Rodder:** 3208 Cat, 13,637 miles, Pony motor, 300 CID Ford engine, only 101 hrs., like new.  
.....\$28,500 OBO  
**401-727-8600** P1



**1994 Kenworth K300 Toilet Service and Septic Pumper Truck:** 286,730 miles, 1500 waste, 250 fresh, 11 hp Honda with Masport pump. Good tires. (Eq. No. BV2)  
.....\$20,000  
**530-243-0657** P1



**1991 International Model 8100:** Cat 350 hp, 9-spd., air ride, 3600 gal. tank, MEC 8000 pump, visor, SS wheel covers, rebuilt motor, transmission, rear ends. ..\$26,500  
**989-379-3054 or 989-356-9060**  
**Michigan** P2



**2002 International:** 3600 gal. alum. Progress tank with Jetter DT 530 engine, 80% rubber. Good condition. ....\$49,000  
**281-347-2224** P1



**2000 Ford F-550 Toilet Service Truck:** New engine @ 75,000, current mileage 175,173, Satellite pump, 600 waste, 300 fresh. (Eq. No. BV5) .....\$20,000  
**530-243-0657** P1



**Mini Dumpster Truck:** (6) 4 cubic yard boxes, (5) 6 cubic yard boxes, and (2) handicap PJ units. Great and-on for PJ or disposal company.  
**517-206-3938** P1



**1988 Ford:** GWV 29,500 w/Keith Huber tank and jetter, 1800 gal. tank w/auto. hose reel and 1.25' hose. 83 gpm @ 2000 psi, 2,335 miles. ....\$12,500  
**Call Steve at 901-238-0412** P3



**2000 Safe Vac:** 27' Hg vac-loader mounted on Sterling LT 9501, Cat C10 engine 350 hp, 180,504 miles, 1610 blower hours. Great shape. ....\$115,000  
**205-664-2000 or 888-739-0838** P1

# Pumper TRUCK STOP

see photos in COLOR at [www.pumper.com](http://www.pumper.com)



January



**2004 5025 Supersucker:** Mounted on a 2004 Sterling 9513 with a Mercedes 370 hp engine, like new, only 5032 miles and 314 blower hours. ....\$165,000  
**205-664-2000 or 888-739-0838** P1



**1996 Mack CH600:** 3900 gal. tank, Masport HXL 400, heated valves, new virgin rubber, 150' hose, air ride, air conditioning. ....\$49,900  
**320-857-2450** P1



**1998 IHC 4900, Sreco HV-2000 Sewer Jet:** 6 cylinder John Deere diesel upper, DT-466, Allison automatic, 55,115 miles, 1,894 hours. ..\$39,900  
**814-696-4343 - Hollidaysburg, PA** P1



**1992 Volvo:** 300 hp Cummins, 3000 gal. tank, 360 Challenger vac pump. This truck runs and works great, ready to use.  
 .....\$18,000  
**877-898-5104**  
**[hullstruckbodies.com](http://hullstruckbodies.com)** P1



**2000 Sterling:** C-12 Cat, 410 hp, 10-spd., cruise, AC, air ride, new 3500 gal. tank and Jurup R260 vac pump, new paint & tires.  
 .....\$57,500  
**877-898-5104**  
**[hullstruckbodies.com](http://hullstruckbodies.com)** P1



**1985 Chev Top Kick:** Cat 3208 engine, 281,168 miles, 5-spd.-2-spd., 2,000 gal. tank, Masport H75 water cooled vac pump, 200' suction hose, large side box, excellent condition. Call for maint. records.  
 .....\$17,000  
**330-856-3042 - Ohio** P1



**2000 Freightliner FLD 112:** C-10 CAT 370 hp w/Jakes, 10-spd., 12 FA/40 RA air-leaf susp., new 80 BBL vac tank with new 350 cfm liquid cooled Wallenstein vac pump. Excellent condition and ready to work. Only 370,000 miles!! .....\$61,500 OBO  
**303-772-4019** P1



**2005 Peterbilt "Juggler":** 500 cfm blower, reel for hose, truck has 50,000 miles, AC, 10-spd. Located in Qc, Canada.  
 .....\$145,000 Cdn.  
**819-827-2772 or**  
**[m.gascon@videotron.ca](mailto:m.gascon@videotron.ca)** P1

**BE ONLINE & IN PUMPER, CLEANER OR MSW FOR ONLY \$125!**

Please print ad legibly with correct punctuation and PHONE NUMBER. Don't forget to send photo!

**RATE** \$125 PER AD, PER MONTH, PER PUBLICATION WITH A 30-WORD MAXIMUM – **PLEASE NOTE:** You can only advertise **ONE TRUCK** for sale per ad.

**DEADLINES** **PUMPER: 10TH OF THE MONTH • CLEANER & MSW: 1ST OF THE MONTH** – For example: Jan. 1st would be the deadline for Feb. Cleaner.

**ADVANCE PAYMENT** **NO BILLING FOR TRUCK STOP ADS.** Payment must be received in **ADVANCE** before publishing.

Enclosed is \$ \_\_\_\_\_ for \_\_\_\_\_ ad(s) to run \_\_\_\_\_ month(s) in

**PUMPER/Pumper Trader**  **MSW**  **CLEANER**  **ALL 3 PUBLICATIONS (TRIPLE DOLLAR AMOUNT)**

Company Name \_\_\_\_\_

Address \_\_\_\_\_ Phone \_\_\_\_\_

City \_\_\_\_\_ State \_\_\_\_\_ Zip \_\_\_\_\_

• **MAIL** this completed form with payment and photo to:  
 COLE Publishing Inc., P.O. Box 220, Three Lakes, WI 54562  
 (Make check/money order payable to: COLE Publishing Inc.)

• **ONLINE** ad form at: [www.pumper.com](http://www.pumper.com); [www.pumpertrader.com](http://www.pumpertrader.com),  
[www.cleaner.com](http://www.cleaner.com), [www.mswmag.com](http://www.mswmag.com)

• **FAX** this completed form to: 715.546.3786 and **E-MAIL** photo to:  
[truckstop@mswmag.com](mailto:truckstop@mswmag.com), [truckstop@pumper.com](mailto:truckstop@pumper.com), [truckstop@cleaner.com](mailto:truckstop@cleaner.com)

**PLEASE FILL OUT CREDIT CARD INFORMATION COMPLETELY:**

CREDIT CARD NO. \_\_\_\_\_ V-CODE \_\_\_\_\_ EXP. DATE \_\_\_\_\_

CARDHOLDER NAME \_\_\_\_\_ PHONE \_\_\_\_\_

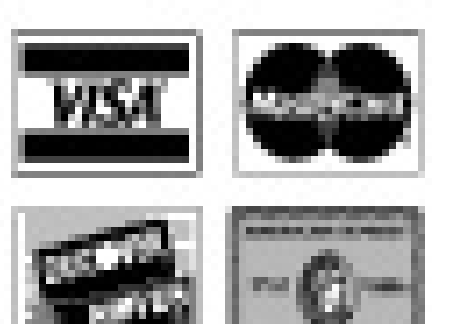



**Juggler™**

The **ONLY** **NSF** **CERTIFIED,**

solid-liquid separator  
for grease traps and  
septic tanks that's  
**SMARTER** and  
**GREENER** than  
a standard  
Pumper truck!

Visit us at  
Booth 9017  
Feb 28 - March 1, 2008  
at the  
Pumper & Cleaner Show  
in Louisville, KY



ISO  
9001  
(2000)

**labrie**  
environmental group

Contact Robert Lamarche at ☎ 1 514 919-0347 | New video at [www.labriegrup.com](http://www.labriegrup.com)

## Your Source for Septic Inspection Equipment!

### CAMERAS, LOCATORS & TRANSMITTERS



### SLUDGE JUDGE SAMPLERS

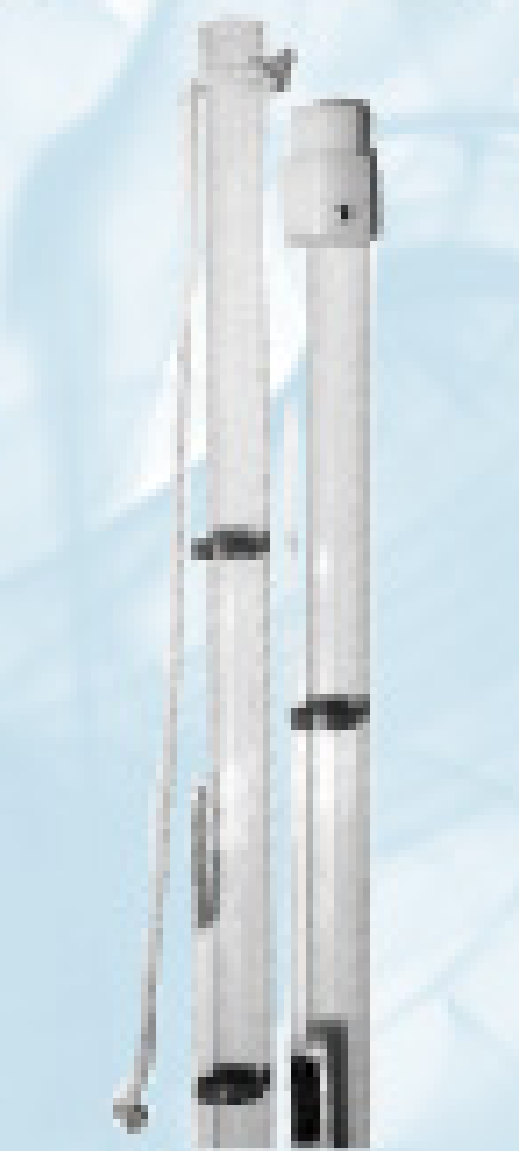

### SOIL PROBES

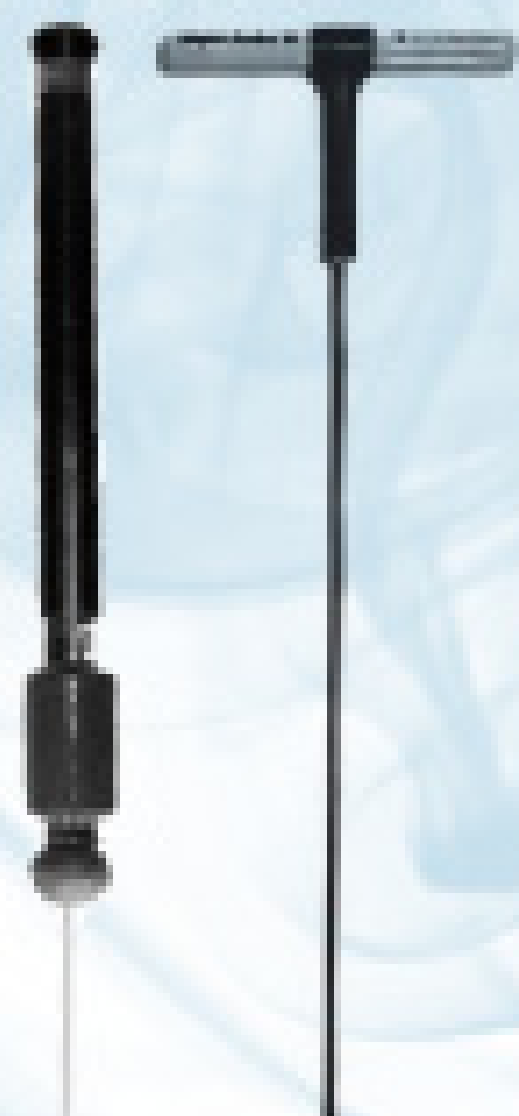

### EXTEND-A-VUE™ INSPECTION MIRRORS

- Mirror Swivels 180°
- Acrylic Mirror Resists Scratching & Breaking
- Optional Light Kit



### MINI MAX CONFINED SPACE GAS MONITOR

Special Pricing, Call Today!



- Full 2-Year Warranty
- Low Cost of Ownership

### MASTER CATCH BASIN SPOONS



### SOIL AUGER



### WASTEWATER ANALYSIS

- Works out of the box
- Easy Calibration



### RV PUMPOUT KIT



### LEAK DETECTION

Dye or Smoke



### PH METERS

- Works out of the box
- Easy Calibration
- Temperature Compensation



### SUREPOINT SEPTIC MARKERS

- Available with your Custom Message or Logo
- Guaranteed Unbreakable



Booth 8069

**RABCO**  
**800-2-DRAINS**

21 Crestway • Hamden, CT 06514  
Ph (203) 230-1693 • (800) 237-2467  
Fx (203) 230-2956 • (800) 535-3332

[www.PumperSupply.com](http://www.PumperSupply.com)



Join hundreds of pumpers who have come to rely on our products!

# PRO-PUMP®

Visit Booth #4094 at Pumper Expo!

The Finest Name in Biological Products for Septic Systems, Anaerobic and Aerobic Systems, Absorption System Recovery, Odor Elimination and More...

## Get More Income with Every Tank Pumped!



### SEPTIC SAVER

### Introducing New PRO-PUMP®/SEPTIC SAVER!

PRO-PUMP®/SEPTIC SAVER is a combo pack of our two best selling septic treatments: PRO-PUMP®/HC & PRO-PUMP®/SP packets, bundle packed as a monthly (12) treatment program. Complete with instructions and two leak detection tablets, this great new item is ideal for increasing your sales on every service call as well as assuring proper septic system care.

The PRO-PUMP® biological series is designed to meet a wide range of on-site wastewater applications with unmatched performance!

- Septic System Treatment
- Absorption System Recovery
- Aerobic System Treatment
- Drain & Grease Traps
- Solids Reduction
- Odor Control
- Satisfied Customers!

The Best Microbial Technology Available Today!



Over the years our customers have come to value the ability of PRO-PUMP®/HC to resolve tough system problems and even improve absorption flow in failed systems.

**PRO-PUMP® PRODUCTS ARE DISTRIBUTED EXCLUSIVELY THROUGH SEPTIC PROFESSIONALS!**

**Sales Materials & Technical Support at No Charge!**

We provide technical support, combined with informative sales and marketing materials, and we don't sell direct to the consumer! All web-based inquiries are forwarded on to you!

**Solving Problems, Naturally!**

## Ecological Laboratories INC.

CORPORATE OFFICES: 13 Hendrickson Ave., Lynbrook, NY 11563  
TOLL FREE: 1-800-326-7867 • FAX: 516-823-3440 • EMAIL: info@propump.com

Visit our web site at: [www.propump.com](http://www.propump.com)





# We pay attention to the details.

- Fabricated to the best industry standards using the highest quality products available
- Custom configurations to your specifications
- VISA, American Express, MasterCard, & Discover
- Fast, same day shipping, low freight rates



Booth 4160

**ATLANTA  
RUBBER &  
HYDRAULICS**

1640 D Sands Place  
Marietta, GA 30067  
Toll Free: 800.282.6272  
Phone: 770.955.5225  
Fax: 770.955.2377  
e-mail: dragsdale@atlantarubber.com

We've got your  
Septic Tank **COVERED**  
and Covered **"RIGHT"**



419-282-5559  
CALL TODAY!



Fits Standard 18" and 24"  
Double Wall Corrugated Pipe

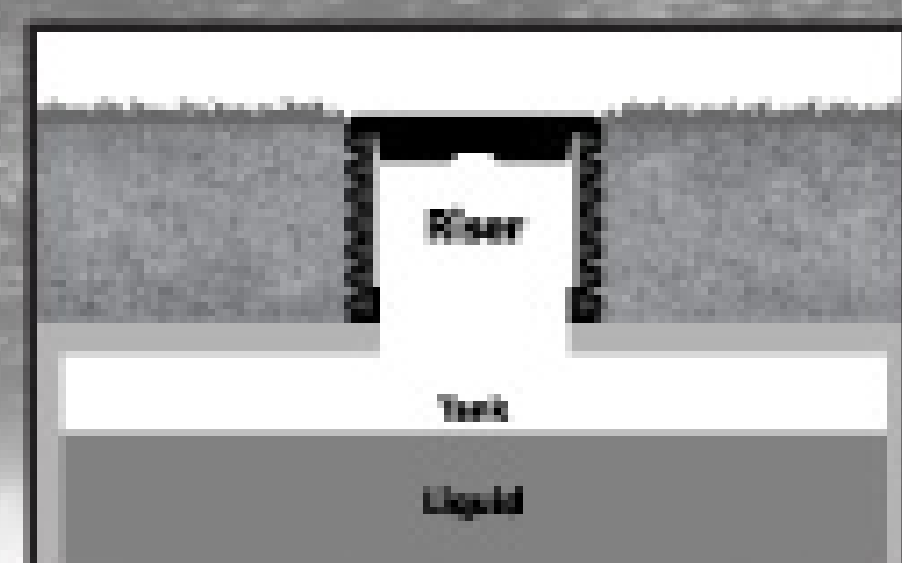

Double wall pipe  
furnished by installer

Stop Infiltration with a  
New Tank Adapter



**NEW!**  
Now with Safety Screws

- Strong green heavy wall polyethylene yet lightweight
- Fits standard 18" & 24" double wall corrugated pipe
- Gaskets and safety hardware included with all covers
- Can be filled with sand on site for added weight
- Can be customized with your name embossed or stamped



Booth 9206

[www.hedstromplastics.com](http://www.hedstromplastics.com)



1401 Jacobson Avenue  
Ashland, Ohio 44805



#7046 & 7047



toll free:  
**(866) 457-5425**

# EXPLORER

## Toilet transporters

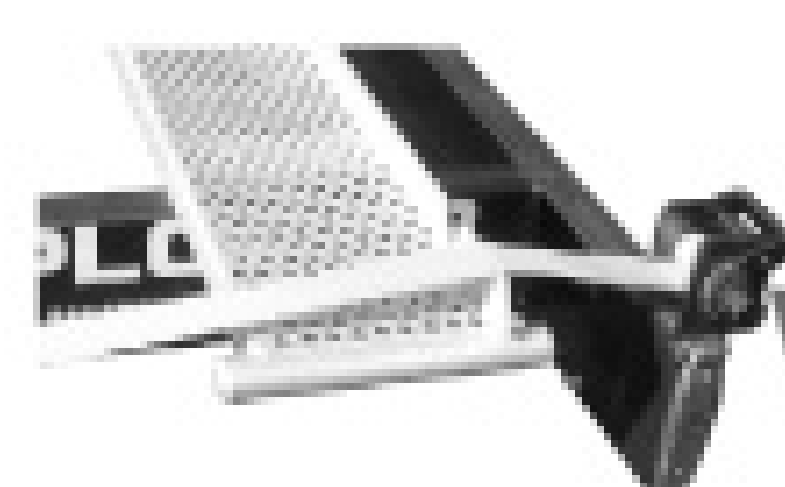

Secure Transportation  
for portable toilets with  
wooden or plastic skids!



**POSI-STRAP**

**POSI-CLAMP**

**Florida**

STEVE BAE ENTERPRISES  
Tel: (407) 709-8175  
Fax: (407) 822-3998  
Apopka FL

**Texas**

WOYT ENTERPRISES  
Tel: (903) 586-6493  
Fax: (903) 541-0874  
Jacksonville TX

**California**

PLUMAS SANITATION  
Tel: (530) 832-0370  
Fax: (530) 832-0373  
Portola CA

**Colorado**

Columbia Sanitary  
Tel: (303) 526-5370  
Fax: (303) 526-0686  
Golden CO

Manufactured by:

**McKEE TECHNOLOGIES INC.**  
ELMIRA, ONTARIO, CANADA N3B 2Z7

**YOUR CHOICE OF:  
STEEL, ALUMINUM OR  
STAINLESS TANKS!**



**IMPERIAL  
INDUSTRIES INC.  
800-558-2945**

**WE DIDN'T JUST INHERIT THE NAME "IMPERIAL",  
WE EARNED IT WITH "IMPERIAL" QUALITY/DESIGN/SERVICE**

**CUSTOM MANUFACTURED PARTS/REPLACEMENT PARTS • VACUUM PUMP SALES & SERVICE  
"24" HOUR ON-LINE PARTS SHOPPING**



**UNITS IN STOCK AND READY FOR DELIVERY:**

- 2500 Gallon Steel & Aluminum Tanks
- 3600 Gallon Steel & Aluminum Tanks
- 4000 Gallon Aluminum Tanks
- (1) 3200 Gallon Steel Tank

**\$111,192.00 W/FET**

Call Jim Stieber or Brad Rybarczyk for details!

**PORTABLE TOILET SERVICE UNITS, BOTH STEEL AND ALUMINUM  
IN STOCK AND READY TO SHIP AT ALL TIMES!**



**STOCK UNITS**

- 875 Gallon Steel Tank 300/575
- 1100 Gallon Aluminum Tank 400/700
- 2150 Gallon Aluminum Tank 550/1600
- All on Ford F-Series Chassis'



**Booth 2186**



**V&H AUTOMOTIVE**  
Marshfield, WI 54449  
**Randy Tischendorf**

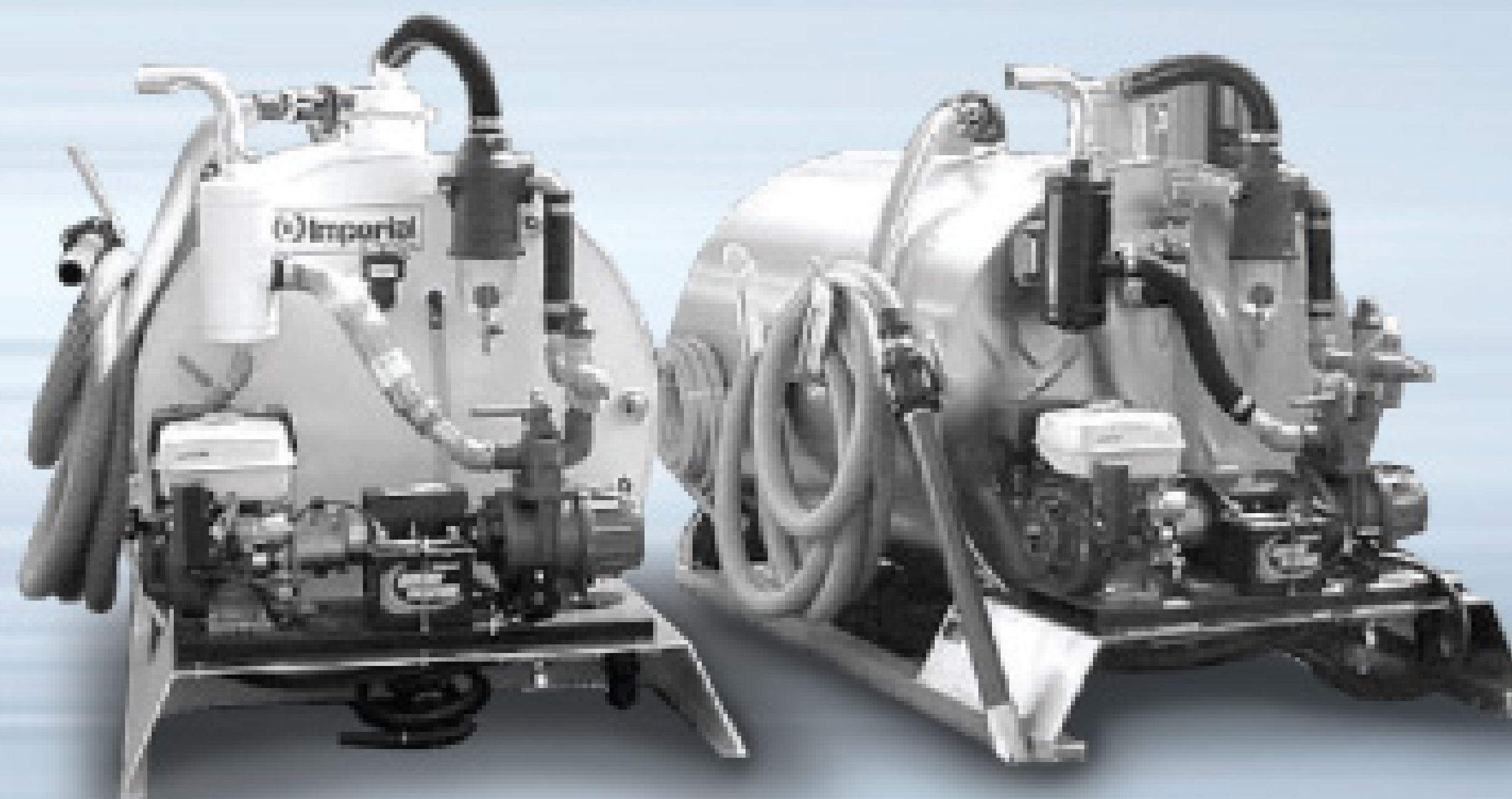

**IMPERIAL**  
P.O. Box 1685 • Wausau, WI 54402  
**Tom Aerts**

**800-722-7382, ext. 244 | [www.imperialind.com](http://www.imperialind.com) | 800-558-2945, ext.317**



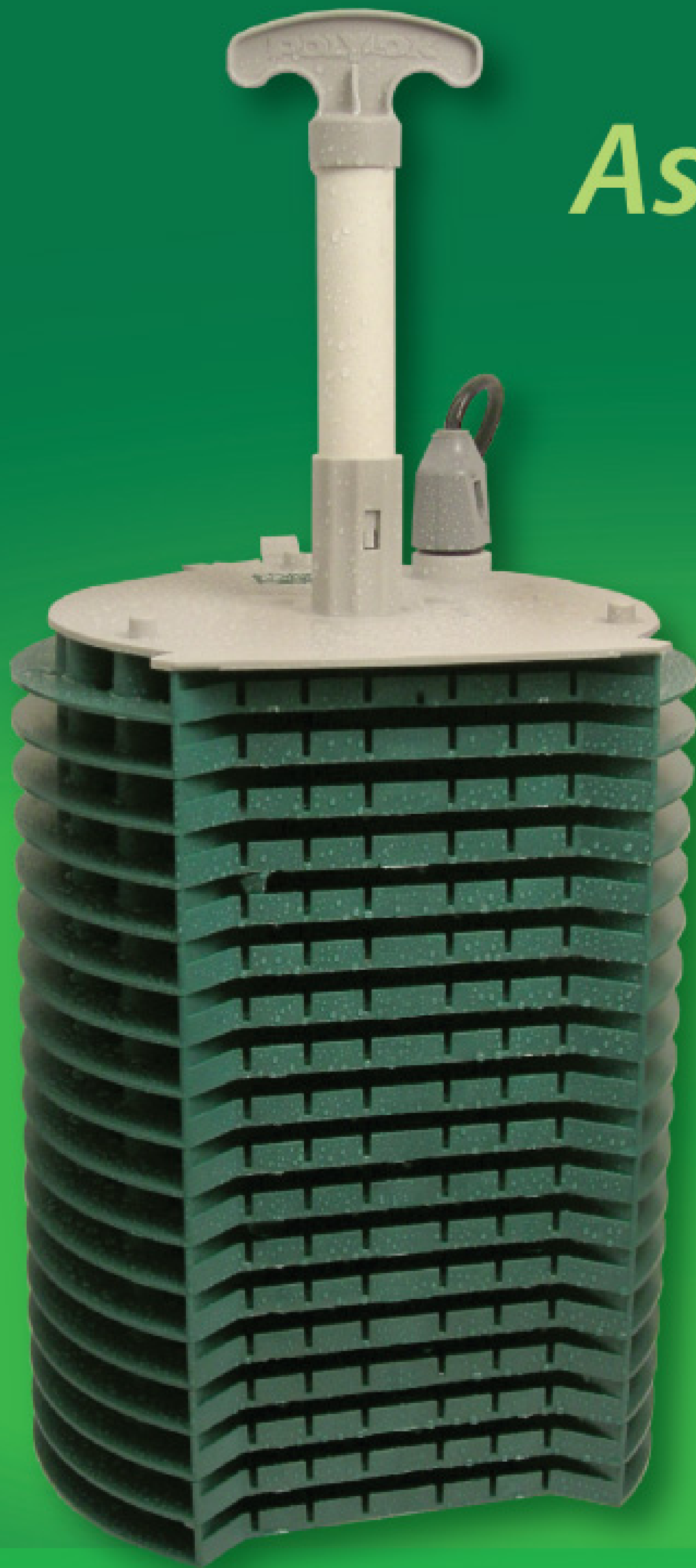

# As Green as it Gets!

For all your Onsite  
Wastewater Needs



Booth 3115



Filter Alarms



Pumps



Pre-Assembled Basin



Flow Controller



Orifice Shields



1-800-701-3942

For a Free catalog or to see other products call or visit our website: [www.zabelzone.com](http://www.zabelzone.com)

# PERFORMANCE IS EVERYTHING



**When you're in the driver's seat,  
performance is what counts.**

*Quick response time ~ Products built to last ~ Crowd-pleasing innovations*

PolyJohn's high-performance team has everything you need to stay on track and ahead of the competition. Plus, the best pit crew in the field with our expert area business managers there to personally help you win the race.



*Stop by our booth in Louisville and race against Formula One Champion, **Felipe Massa**, who will set the "time to beat" on our racing simulators.*

*Feel the excitement, hear the crowd roar as you watch "racing challengers" try to beat his time at The 2008 Pumper Show, February 28 - March 1. You may even be able to sit in the driver's seat yourself! Sign up today! Limited pole positions are available at [www.polyjohn.com](http://www.polyjohn.com). Prizes will be awarded.*

**IN YOUR DRIVE TO BE THE BEST, WE'RE THERE WHEN YOU NEED US!**

800-292-1305  
[www.polyjohn.com](http://www.polyjohn.com)

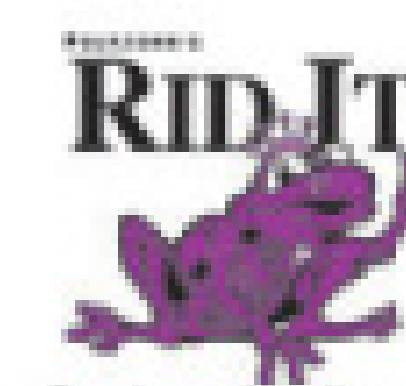

EARN MORE • SELL MORE • SERVICE BETTER



# PRESVAC

**The Leader  
In Vacuum  
Technology**

**Bright finish Aluminum Tanks**  
for the Septic Pumping  
Industry... Standard  
tank models from  
2,000 gallons  
to 5,000 gallons.



**Hydro-Trencher** - 5300 CFM air flow/28" HG vacuum  
with 8" hydraulic actuated boom, 3000 U.S. gal.  
debris tank (stain. steel 316), 1000 U.S. gal.  
water tank (stain. steel 316), 9 G.P.M. water  
pump with pressures to 5800 p.s.i.

**Powervac 5300 for wet/dry operation**

5300 CFM air flow/28" HG vacuum, Dump chutes  
extended to rear of truck, Stainless steel 316,  
DOT 407/412



**Liquid Truck**

Designed for industrial liquid applications

[www.presvac.com](http://www.presvac.com)



Booth 1154

**Nationwide Sales & Service**  
**Call a Presvac Dealer in Your Area!**

4131 Morris Drive • Burlington, Ontario, Canada L7L 5L5 • Fax: 905-681-0411

**905-637-2353 • 800-387-7763**